

25
YEARS



2015

VOREL 



STHOR



LUND



FLO 

FALA 



 POWER UP



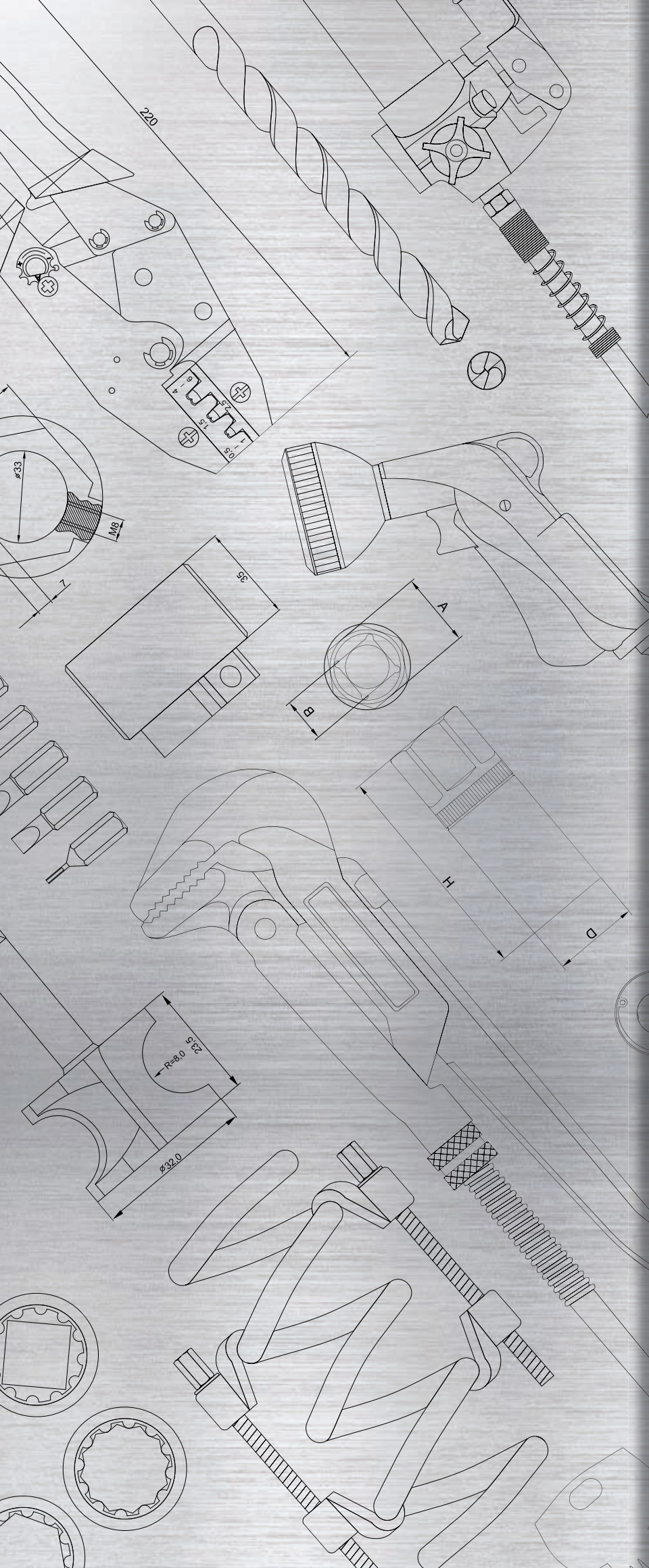

TOYA SA
ul. Sołtysowicka 13-15
51-168 Wrocław
☎ (+48 71) 32 46 200
fax: (+48 71) 32 46 370

sales@yato.pl (sale)
export@yato.pl (export)
import@yato.pl (import)

ODDZIAŁ WARSZAWSKI
Teren ProLogis Park Nadarzyn
al. Kasztanowa 160
05-831 Młochów k. Warszawy

☎ (+48 22) 73 82 800
☎ (+48 22) 73 82 828
sales@yato.pl (sale)
export@yato.pl (export)

1 Spanners
Klucze

6-13



2 Sockets, accessories & sets
Klucze nasadowe, akcesoria i zestawy

14-19



3 Screwdrivers & screwdriver bits
Wkrętaki i końcówki wkrętakowe

20-35



4 Pliers & pipe wrenches
Szczypce i klucze do rur

36-45

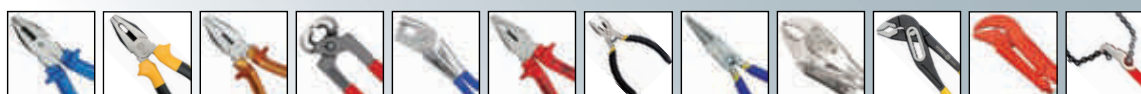

5 Electrician tools
Narzędzia dla elektryków

46-51



6 Hammers, chisels, punches & axes
Młotki, dłuta, przecinaki i siekiery

52-61

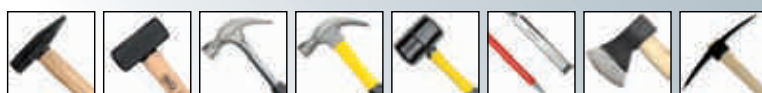

7 Clamps & vices
Ściski i imadła

62-67



8 Cutting tools
Narzędzia tnące

68-103

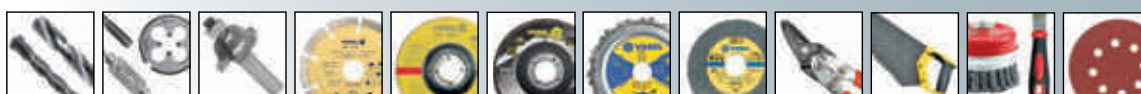

9 Hydraulic tools 104-111

Narzędzia hydrauliczne



10 Fastening tools 112-121

Narzędzia do łączenia

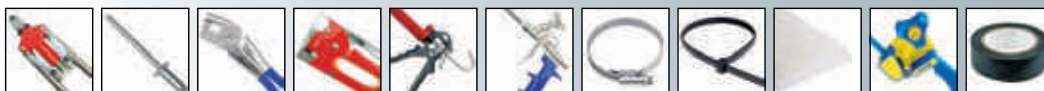

11 Plastering & bricklaying tools 122-147

Narzędzia budowlane i malarskie

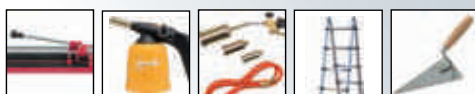

12 Measuring tools 148-157

Narzędzia miernicze



13 Pneumatic tools 158-169

Narzędzia pneumatyczne



14 Special automotive tools & equipment 170-189

Narzędzia i wyposażenie warsztatu samochodowego



15 Power tools & accessories 190-219

Elektronarzędzia i akcesoria



16 Welding equipment 220-225

Sprzęt spawalniczy



17 Safes, padlocks & locks 226-239
Sejfy, klódki i zamki



18 Tool bags & boxes 240-245
Torby i skrzynki narzędziowe



19 Household equipment 246-269
Gospodarstwo domowe

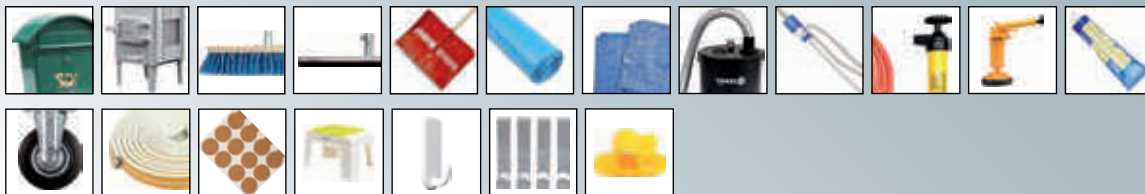

20 Health & safety products 270-285
Artykuły BHP

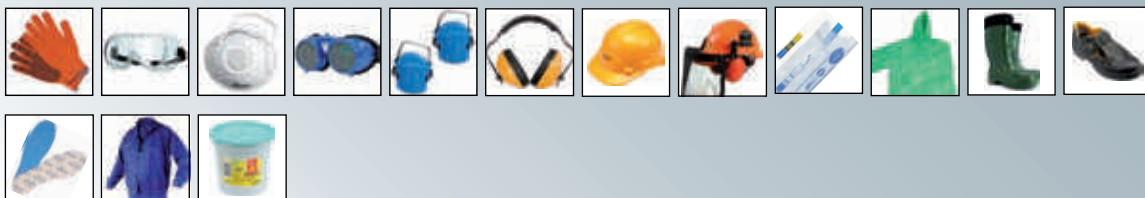

21 Electric products 286-295
Artykuły elektryczne



22 Garden tools & power tools 296-347
Narzędzia i elektronarzędzia ogrodowe



23 Sanitary ware & hydraulics 348-363
Armatura sanitarna i hydraulika



Memo

1

Spanners Klucze

Combination spanners Klucze płasko-oczkowe

8-9



Combination spanners & sets, polished head

Klucze płasko-oczkowe i zestawy,
polerowana główka..... 8

Combination spanners & sets, satin finish CrV

Klucze płasko-oczkowe i zestawy,
wykończenie satynowe CrV..... 8

Combination ratchet wrenches Klucze płasko-oczkowe z grzechotką

9-10



Combination ratchet wrenches

Klucze płasko-oczkowe z grzechotką..... 9

Combination ratchet wrench sets

Zestawy kluczy płasko-oczkowych z grzechotką..... 10

Double ratchet wrenches Klucze oczkowe dwustronne z grzechotką

10

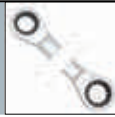

Double ratchet wrenches

Klucze oczkowe dwustronne z grzechotką..... 10

Double ratchet wrench sets

Zestawy kluczy oczkowych dwustronnych z grzechotką..... 10

Double open end spanners Klucze płaskie

10-11



Double open end spanners & sets, polished head

Klucze płaskie i zestawy, polerowana główka..... 10

Double open end spanner sets, satin finish CrV

Zestawy kluczy płaskich,
wykończenie satynowe CrV..... 10

Bi-hexagonal ring spanners Klucze oczkowe odgięte

11



Bi-hexagonal ring spanners & sets, polished head

Klucze oczkowe odgięte i zestawy,
polerowana główka..... 11

Swivel socket spanners & sets Klucze nasadowe przegubowe i zestawy

11-12



Open end swivel socket spanners & sets

Klucze płasko-nasadowe i zestawy..... 11

Double ended swivel socket wrenches

Klucze nasadowo-przegubowe..... 12

T-type deep socket wrenches Klucze nasadowe typu „T”

12



Box end wrenches Klucze rurowe

12



L-type wrenches

Klucze nasadowe typu „L”

12



Multipipe wrenches

Klucze uniwersalne

12



Double socket ratchet handles

Dwustronne klucze nasadkowe z grzechotką

13



Adjustable wrenches

Klucze nastawne

13



Torque wrenches

Klucze dynamometryczne

13



PL Klucz płasko-oczkowy
 GB Combination spanner
 D Maulringschlüssel
 RUS Ключ комбинированный

CZ Ploché a očkový kľúč
 RO Chele combinata
 H Kulcs villás-csillag
 E Combinada con llave de estrella



No.	mm	
51060	6	200/1200
51070	7	200/1000
51080	8	100/600
51090	9	50/600
51100	10	50/600
51110	11	50/400
51120	12	50/400
51130	13	50/400
51140	14	50/300
51150	15	50/300
51160	16	50/200
51170	17	20/200
51180	18	25/200
51190	19	30/120
51200	20	20/160
51210	21	20/120
51220	22	20/120
51240	24	15/90
51270	27	10/60
51300	30	10/40
51320	32	10/40

PL Komplet kluczy płasko-oczkowych
 GB Combination spanner set
 D Maulringschlüsselsatz
 RUS Набор ключей комбинированных

CZ Souprava plochých a očkových kľúčů
 RO Set chele combinata
 H Kulcskészlet villás-csillag clip
 E Juego de combinadas con llave de estrella



No.	mm	pcs	
51560	8; 10; 12; 13; 14; 17	6	15/60
51590	6; 8; 10; 12; 13; 14; 17; 19	8	10/40
51630	6; 7; 8; 9; 10; 11; 12; 13; 14; 17; 19; 22	12	5/20
51640	6; 7; 8; 9; 10; 11; 12; 13; 14; 17; 19; 21; 24; 27; 32	15	2/12
51645	6; 7; 8; 9; 10; 11; 12; 13; 14; 15; 16; 17; 18; 19; 21; 22; 24; 27; 30; 32	20	8

PL Komplet kluczy płasko-oczkowych
 GB Combination spanner set
 D Maulringschlüsselsatz
 RUS Набор ключей комбинированных

CZ Souprava plochých a očkových kľúčů
 RO Set chele combinata
 H Kulcskészlet villás-csillag clip
 E Juego de combinadas con llave de estrella



No.	mm	pcs	
51580	6; 8; 10; 11; 13; 14; 17; 19	8	5/50
51620	6; 7; 8; 9; 10; 11; 12; 13; 14; 17; 19; 22	12	5/20
51650	6; 7; 8; 9; 10; 11; 12; 13; 14; 15; 16; 17; 18; 19; 20; 21; 22; 23; 24; 25; 26; 27; 28; 30; 32	25	4

PL Komplet kluczy płasko-oczkowych
 GB Combination spanner set
 D Maulringschlüsselsatz
 RUS Набор ключей комбинированных

CZ Souprava plochých a očkových kľúčů
 RO Set chele combinata
 H Kulcskészlet villás-csillag clip
 E Juego de combinadas con llave de estrella



No.	mm	pcs	
50850	8; 10; 12; 13; 14; 17	6	4/40
50861	6; 8; 10; 13; 14; 17; 19; 22	8	4/32
50871	6; 7; 8; 9; 10; 11; 12; 13; 14; 17; 19; 22	12	2/20

PL Komplet kluczy płasko-oczkowych
 GB Combination spanner set
 D Maulringschlüsselsatz
 RUS Набор ключей комбинированных

CZ Souprava plochých a očkových kľúčů
 RO Set chele combinata
 H Kulcskészlet villás-csillag clip
 E Juego de combinadas con llave de estrella



No.	size / rozmiar	pcs	
50880	1/4" (6.3 mm); 5/16" (7.9 mm); 3/8" (9.5 mm); 7/16" (11.1 mm); 1/2" (12.7 mm); 9/16" (14.3 mm); 5/8" (15.9 mm); 11/16" (17.5 mm); 3/4" (19.0 mm)	9	10

PL Klucz płasko-oczkowy
 GB Combination spanner
 D Maulringschlüssel
 RUS Ключ комбинированный

CZ Ploché a očkový kľúč
 RO Chele combinata
 H Kulcs villás-csillag
 E Combinada con llave de estrella



No.	mm	
51671	6	20/400
51672	7	20/400
51673	8	20/400
51674	9	20/400
51675	10	20/320
51676	11	20/240
51677	12	20/240

No.	mm	
51678	13	20/200
51679	14	20/200
51680	15	20/200
51681	16	20/200
51682	17	20/160
51683	18	20/160
51684	19	20/160



PL Klucz płasko-oczkowy
GB Combination spanner
D Maulringschlüssel
RUS Ключ комбинированный

CZ Plochý a očkový klíč
RO Chele combinata
H Kulcs villás-csillag
E Combinada con llave de estrella

CrV



>>>



No.	mm	
51685	20	20/120
51686	21	20/120
51687	22	20/120
51688	23	10/80
51689	24	10/80
51690	25	10/60
51691	26	10/40
51692	27	10/40
51693	28	10/40
51694	29	10/40
51695	30	10/40
51696	32	10/40

PL Komplet kluczy płasko-oczkowych
GB Combination spanner set
D Maulringschlüsselsatz
RUS Набор ключей комбинированных

CZ Souprava plochých a očkových klíčů
RO Set chei combinata
H Kulcskészlet villás-csillag
E Juego de combinadas con llave de estrella

12
PCS

CrV



No.	mm	pcs	
51710	6: 8: 10: 11: 12: 13: 14: 15: 17: 18: 19: 22	12	20

PL Klucz płasko-oczkowy z grzechotką
GB Combination ratchet wrench
D Ratschenringmaulschlüssel
RUS Ключ комбинированный с трещоткой

CZ Klíč očkoplochý ráčnový
RO Chele combinata cu crichet
H Csillag-villás kulcs racsnlis
E Llave combinada fija abierta y carraca

CrV

45T
60Si2Mn

No.	mm	
52652	10	10/100
52653	11	10/100
52654	12	10/100
52655	13	10/100
52656	14	10/100

PL Komplet kluczy płasko-oczkowych
GB Combination spanner set
D Maulringschlüsselsatz
RUS Набор ключей комбинированных

CZ Souprava plochých a očkových klíčů
RO Set chei combinata
H Kulcskészlet villás-csillag clip
E Juego de combinadas con llave de estrella

CrV



No.	mm	pcs	
51720	8: 10: 12: 13: 14: 17	6	4/40
51721	6: 8: 10: 12: 13: 14: 17: 19	8	4/32
51722	6: 7: 8: 9: 10: 11: 12: 13: 14: 17: 19: 22	12	2/20

PL Komplet kluczy płasko-oczkowych
GB Combination spanner set
D Maulringschlüsselsatz
RUS Набор ключей комбинированных

CZ Souprava plochých a očkových klíčů
RO Set chei combinata
H Kulcskészlet villás-csillag
E Juego de combinadas con llave de estrella

8
PCS

CrV



No.	mm	pcs	
51705	8: 10: 12: 13: 14: 15: 17: 19	8	30

PL Komplet kluczy płasko-oczkowych
GB Combination spanner set
D Maulringschlüsselsatz
RUS Набор ключей комбинированных

CZ Souprava plochých a očkových klíčů
RO Set chei combinata
H Kulcskészlet villás-csillag
E Juego de combinadas con llave de estrella

25
PCS

CrV



No.	mm	pcs	
51715	6: 7: 8: 9: 10: 11: 12: 13: 14: 15: 16: 17: 18: 19: 20: 21: 22: 23: 24: 25: 26: 27: 28: 30: 32	25	4

- PL Zestaw kluczy płasko-oczkowych z grzechotką
 GB Combination ratchet wrench set
 D Ratschenringmaulschlüssel-satz
 RUS Ключи комбинированные трещоточные
 CZ Klíče ráčnové sada
 RO Set chei combineate
 H Racsnis csillag-villás kulcs készlet
 E Juego de llaves planas con matraca



No.	mm	pcs	
52661	10; 13; 17; 19	4	10/20

- PL Zestaw kluczy płasko-oczkowych z grzechotką
 GB Combination ratchet wrench set
 D Ratschenringmaulschlüssel-satz
 RUS Ключи комбинированные трещоточные
 CZ Klíče ráčnové sada
 RO Set chei combineate
 H Racsnis csillag-villás kulcs készlet
 E Juego de llaves planas con matraca



No.	mm	pcs	
52830	8; 10; 12; 13; 15; 17	6	6
52831	8; 10; 13; 14; 15; 16; 17; 19	8	6

- PL Klucz oczkowy dwustronny z grzechotką
 GB Double ratchet wrench
 D Ring-maulschlüssel
 RUS Ключ комбинированный
 CZ Plochy a očkový klíč
 RO Cheie plato-inelară
 H Kulcs villás-csillag
 E Combinada con llave de estrella



No.	mm	
52871	6x8	20/160
52872	10x11	20/160
52873	12x13	20/120
52874	14x15	20/100
52875	16x18	20/60
52876	17x19	20/60
52877	21x22	20/40

- PL Komplet kluczy oczkowych dwustronnych z grzechotką
 GB Double ratchet wrench set
 D Ringschlüsselsatz
 RUS Набор ключей накидных
 CZ Očkové klíče
 RO Set chei inelare
 H Csillagkulcs készlet
 E Llaves de anillo



No.	mm	pcs	
52880	6x8; 10x11; 12x13; 14x15; 17x19	5	5/10

- PL Klucz płaski
 GB Double open end spanner
 D Doppelmaulschlüssel
 RUS Ключ рожковый
 CZ Plochy klíč
 RO Cheie fixa
 H Villáskulcs
 E Llave fija



No.	mm	
50070	6x7	100/1000
50090	8x9	60/600
50100	8x10	60/600
50110	10x11	60/600
50120	10x13	50/500
50130	12x13	50/500
50150	14x15	50/300
50170	13x17	50/300
50190	17x19	30/180
50220	19x22	30/180
50270	24x27	25/100
50330	30x32	15/60

- PL Komplet kluczy płaskich
 GB Double open end spanner set
 D Doppelmaulschlüsselsatz
 RUS Набор рожковых ключей
 CZ Souprava plochých klíčů
 RO Set chei fixe
 H Kulcskészlet, villás
 E Juego de llaves fijas



No.	mm	pcs	
50560	6x7; 8x9; 10x11; 12x13; 14x15; 16x17	6	20/80
50590	6x7; 8x9; 10x11; 12x13; 14x15; 16x17; 18x19; 20x22	8	10/40
50610	6x7; 8x9; 10x11; 12x13; 14x15; 16x17; 18x19; 20x22; 24x27; 30x32	10	5/20
50630	6x7; 8x9; 10x11; 12x13; 14x15; 16x17; 18x19; 20x22; 21x23; 24x26; 25x28; 27x32	12	5/15

- PL Komplet kluczy płaskich
 GB Double open end spanner set
 D Doppelmaulschlüsselsatz
 RUS Набор рожковых ключей
 CZ Souprava plochých klíčů
 RO Set chei fixe
 H Kulcskészlet, villás
 E Juego de llaves fijas



No.	mm	pcs	
50580	6x7; 8x9; 10x11; 12x13; 14x15; 16x17; 18x19; 20x22	8	10/40
50620	6x7; 8x9; 10x11; 12x13; 14x15; 16x17; 18x19; 20x22; 21x23; 24x26; 25x28; 27x32	12	5/15

PL Komplet kluczy płaskich
GB Double open end spanner set
D Doppelmaulschlüsselsatz
RUS Набор рожковых ключей

CZ Souprava plochých klíčů
RO Set chei fixe
H Kulcskészlet, villás
E Juego de llaves fijas



VOREL

No.	mm	pcs	
51740	6x7; 8x9; 10x11; 12x13; 14x15; 16x17	6	4/40
51741	6x7; 8x9; 10x11; 12x13; 14x15; 16x17; 18x19; 20x22	8	4/24

PL Klucz oczkowy odgięty
GB Bi-hexagonal ring spanner
D Doppelringschlüssel
RUS Ключ накидной изогнутый

CZ Očkový klíč ohnutý
RO Cheie inelaro-curbată
H Hajlítottszerű csillagkulcs
E Llave de estrella



No.	mm	
52090	8x9	50/300
52100	8x10	50/300
52110	10x11	50/300
52120	10x13	50/200
52130	12x13	50/200
52170	13x17	30/120
52190	17x19	25/100
52220	19x22	20/80
52270	24x27	10/60
52340	30x32	5/40

PL Komplet kluczy oczkowych odgiętych
GB Bi-hexagonal ring spanner set
D Doppelringschlüsselsatz
RUS Набор ключей накидных изогнутых

CZ Klíče očkové vyhnuté sada
RO Set chei inelare cu cot
H Csillagkulcs készlet
E Juego de llaves de estrella acodadas

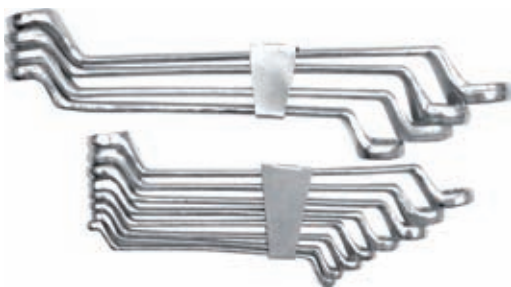

No.	mm	pcs	
52560	6x7; 8x9; 10x11; 12x13; 14x15; 16x17	6	6/36
52570	6x7; 8x9; 10x11; 12x13; 14x15; 16x17; 18x19; 20x22	8	5/20
52630	6x7; 8x9; 10x11; 12x13; 14x15; 16x17; 18x19; 20x21; 22x23; 24x25; 26x27; 28x32	12	2/8

PL Klucz płasko-nasadowy
GB Open end swivel head wrench spanner
D Gabel-gelenk-steckschlüssel
RUS Ключ рожково-торцевой

CZ Plochý nástrčný klíč
RO Cheie combinata: fixa + tubulara
H Kulcs villás-dugó
E Combinada con vaso



No.	mm	
52680	8	20/200
52700	10	20/200
52710	11	20/200
52720	12	20/200
52730	13	20/200
52740	14	20/200
52750	15	25/100
52770	17	25/100
52790	19	25/50
52820	22	25/50

PL Komplet kluczy oczkowych odgiętych
GB Bi-hexagonal ring spanner set
D Doppelringschlüsselsatz
RUS Набор ключей накидных изогнутых

CZ Klíče očkové vyhnuté sada
RO Set chei inelare cu cot
H Csillagkulcs készlet
E Juego de llaves de estrella acodadas

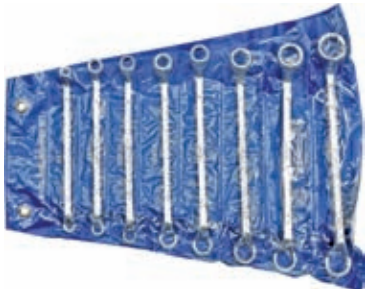

No.	mm	pcs	
52580	6x7; 8x9; 10x11; 12x13; 14x15; 16x17; 18x19; 20x22	8	5/20

PL Klucz płasko-nasadowy, przegubowy
GB Open end swivel head socket wrench
D Maul-steckschlüssel
RUS Ключ рожково-торцевой

CZ Klíč nasad. ploch.
RO Cheie fixe-tubulare
H Kulcs villás-dugó
E Combinada con vaso

**CrV
40**



VOREL

No.	mm	pcs packing	
52840	8	10	200
52841	10	10	200
52842	11	10	160
52843	12	10	160
52844	13	10	160
52845	14	10	160
52846	17	10	100
52847	19	10	80

- PL Komplet kluczy płasko-nasadowych
 GB Open end swivel head socket wrench set
 D Gabel-Gelenk-Steckschlüsselsatz
 RUS Ключи торцово-торцевые
- CZ Ploché nástrčné kľúčové kloubové
 RO Chei plato-tubulare cu articulatie
 H Kulcs villás-csuklós dugó
 E Combinadas con vaso articulado



No.	mm	pcs	Box
52860	10; 11; 13; 14; 17; 19	6	6/24

- PL Klucz nasadowy, przegubowy
 GB Double flexible socket wrench
 D Steckschlüssel, mit Gelenk
 RUS Торцовый, шарнирный гаечный ключ
- CZ Kľúč nástrčný s kloubovým
 RO Cheie fixa, articulata
 H Dugókulcs, csuklós
 E Llave de cubo articulada



No.	mm	pcs packing	Box
52850	8x9	10	200
52851	10x11	10	200
52852	12x13	10	150
52853	14x15	10	100
52854	16x17	10	100
52855	18x19	10	80

- PL Klucz nasadowy typu „T”
 GB T-type socket wrench
 D T-Griff-Steckschlüssel
 RUS Ключ торцевой Т-образный
- CZ Čepový a nástrčný kľúč
 RO Cheie tubulara tip „T”
 H Kulcs, csap-dugó
 E Llave mandril vaso



No.	L (mm)	mm	Box
56710	380	8	50
56720	380	10	50
56730	380	13	50
56740	380	17	50
56750	380	19	50

No.	L (mm)	mm	Box
56770	190	8	50
56780	190	10	50
56790	190	13	50

- PL Komplet kluczy rurowych
 GB Tubular socket wrench set
 D Rohrsteckschlüsselsatz
 RUS Набор ключей трубчатых
- CZ Kľúč trubkový
 RO Chei pt. țevi
 H Csőkulcs
 E Llaves de tubería



No.	mm	pcs	Box
52900	6-22	10	6/24

- PL Klucz nasadowy typu „L”
 GB L-type socket wrench
 D Steckschlüssel gebogen
 RUS Ключ торцевой L-типа
- CZ Nástrčný kľúč fajtkový
 RO Cheie tubulara cu cot tip „L”
 H Kulcs, dugó-pípa
 E Llave de vaso „L”



No.	mm	Box
54600	6	20/240
54610	7	20/240
54620	8	20/240
54630	9	20/240
54640	10	20/240
54650	11	20/200
54660	12	20/200
54670	13	20/200
54680	14	10/100
54690	15	10/100
54700	16	10/100
54710	17	10/80
54720	18	10/80
54730	19	10/80
54750	21	10/60
54760	22	10/60
54780	24	10/40
54860	32	8/16

- PL Klucze uniwersalne
 GB Multipipe wrenches
 D Universalschlüssel
 RUS Ключи универсальные
- CZ Univerzální kľúč
 RO Chei universale
 H Univerzális kulcs
 E Juego de llaves universales



No.	mm	pcs	Box
54000	9-32	2	20/40

2

Sockets, accessories & sets

Klucze nasadowe, akcesoria i zestawy

Sockets**Klucze nasadowe**

16

**Hexagonal sockets 1/2"**

Klucze nasadowe sześciokątne 1/2"..... 16

Hexagonal sockets 3/4"

Klucze nasadowe sześciokątne 3/4"..... 16

Accessories**Akcesoria**

16-17

**Extension bars**

Przedłużki..... 16

Adapters

Redukcje..... 16

Universal joints

Przeguby Cardana..... 16

Sliding T-bars

Pokręta typu „T”..... 16

Speed braces

Rękojeści wygięte..... 17

Ratchet handles**Grzechotki**

17

**Socket & tool sets****Zestawy kluczy nasadowych i narzędziowych**

17-19

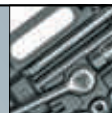
**Socket sets 1/4"**

Zestawy kluczy nasadowych 1/4"..... 17

Socket sets 3/8"

Zestawy kluczy nasadowych 3/8"..... 17

Socket sets 1/2"

Zestawy kluczy nasadowych 1/2"..... 18

Socket sets 3/4"

Zestawy kluczy nasadowych 3/4"..... 18

Tool sets

Zestawy narzędziowe..... 19

- PL Nasadka sześciokątna
 GB Hexagonal socket
 D Sechskantenschlüssel
 RUS Головка шестигранная короткая
 CZ Šestihranný nástavec
 RO Cheie tubulară hexagonală
 H Hatszögű rátét
 E Boquilla hexagonal corta

1/2"
12.5mm



No.	mm	size / rozmiar	
53080	8	1/2" (12.7 mm)	150/300
53100	10	1/2" (12.7 mm)	150/300
53110	11	1/2" (12.7 mm)	150/300
53120	12	1/2" (12.7 mm)	150/300
53130	13	1/2" (12.7 mm)	150/300
53140	14	1/2" (12.7 mm)	150/300
53150	15	1/2" (12.7 mm)	150/300
53160	16	1/2" (12.7 mm)	150/300
53170	17	1/2" (12.7 mm)	125/250
53180	18	1/2" (12.7 mm)	100/200
53190	19	1/2" (12.7 mm)	100/200
53210	21	1/2" (12.7 mm)	75/150
53220	22	1/2" (12.7 mm)	75/150
53240	24	1/2" (12.7 mm)	50/100
53270	27	1/2" (12.7 mm)	50/100
53300	30	1/2" (12.7 mm)	40/80
53320	32	1/2" (12.7 mm)	40/80

- PL Nasadka sześciokątna
 GB Hexagonal socket
 D Sechskantenschlüssel
 RUS Головка шестигранная короткая
 CZ Šestihranný nástavec
 RO Cheie tubulară hexagonală
 H Hatszögű rátét
 E Boquilla hexagonal corta

3/4"
19mm



No.	mm	size / rozmiar	
53400	22	3/4" (19.0 mm)	50
53410	24	3/4" (19.0 mm)	50
53420	27	3/4" (19.0 mm)	50
53430	30	3/4" (19.0 mm)	50
53440	32	3/4" (19.0 mm)	50
53450	36	3/4" (19.0 mm)	50
53460	38	3/4" (19.0 mm)	40
53470	41	3/4" (19.0 mm)	25
53480	46	3/4" (19.0 mm)	20
53490	50	3/4" (19.0 mm)	20

- PL Przedłużka
 GB Extension bar
 D Verlängerung
 RUS Удлинитель для воротка

- CZ 3URCZAR/DFLS/Pravek
 RO Prelungitor
 H Hosszabbító
 E Tubo de prolongación



No.	size / rozmiar	L (mm)	
53610	1/2" (12.7 mm)	125	50/100
53630	1/2" (12.7 mm)	250	25/50



No.	size / rozmiar	L (mm)	
53650	3/4" (19.0 mm)	100	60
53670	3/4" (19.0 mm)	200	25

- PL Redukcja
 GB Adapter
 D Reduktion
 RUS Переходник

- CZ Redukce
 RO Reducție
 H Redukció
 E Reducción



No.	size / rozmiar	
53760	3/8" (9.5 mm) - 1/4" (6.3 mm)	120/240

- PL Przegub Cardana
 GB Universal joint
 D Kardangelenk
 RUS Карданный шарнир

- CZ Kardanový kloub
 RO Articulație Cardanică
 H Kardán csukló
 E Articulación Cardan



No.	size / rozmiar	
53598	1/4" (6.3 mm)	150/300
53599	3/8" (9.5 mm)	100/200
53600	1/2" (12.7 mm)	60/120

- PL Pokrętko typu „T”
 GB Sliding T-bar
 D Handgriff mit gleitstück
 RUS Вороток Т-образный

- CZ Otočná račka typ „T”
 RO Măner clipă tipul „T”
 H „T” alakú hajtókar
 E Mango tipo „T”



No.	size / rozmiar	L (mm)	
53700	1/2" (12.7 mm)	250	25/50



No.	size / rozmiar	L (mm)	
53710	3/4" (19.0 mm)	450	20

Sockets, accessories & sets / Klucze nasadowe, akcesoria i zestawy

PL Rękojeść wygięta
GB Speed brace
D Kurbelverlängerung
RUS Вороток-коловорот

CZ Ohnutá rukojeť
RO Mâner curbat (manivelă)
H Hajlított markolat /korba/
E Mango encorvado /manivela/



No.	size / rozmiar	L (mm)	
53730	1/2" (12.7 mm)	400	40

PL Grzechotka
GB Ratchet handle
D Hebelumschaltknarre
RUS Ключ трещоточный

CZ Řehtačka
RO Antrenor cu clichet
H Racsni
E Llave de carraca



No.	size / rozmiar	L (mm)	
53500	1/4" (6.3 mm)	125	40/80
53520	3/8" (9.5 mm)	195	25/50
53540	1/2" (12.7 mm)	250	20/40

PL Grzechotka
GB Ratchet handle
D Hebelumschaltknarre
RUS Ключ трещоточный

CZ Řehtačka
RO Antrenor cu clichet
H Racsni
E Llave de carraca



No.	size / rozmiar	L (mm)	
53561	1/4" (6.3 mm)	135	40/80
53562	3/8" (9.5 mm)	190	25/50
53563	1/2" (12.7 mm)	240	20/40

PL Grzechotka przegubowa
GB Flexible ratchet handle
D Gelenk-Hebelumschaltknarre
RUS Ключ трещоточный шарнирный

CZ Kloubová řehtačka
RO Antrenor cu clichet, flexibil
H Csuklás racsni
E Llave de carraca articulada

1/2"
12.5mm



No.	size / rozmiar	L (mm)	
53560	1/2" (12.7 mm)	250	25/50

PL Grzechotka
GB Ratchet handle
D Hebelumschaltknarre
RUS Ключ трещоточный

CZ Řehtačka
RO Antrenor cu clichet
H Racsni
E Llave de carraca



No.	size / rozmiar	L (mm)	teeth / zęby	
53571	1/4" (6.3 mm)	150	72	6/36
53572	3/8" (9.5 mm)	200	72	6/36
53573	1/2" (12.7 mm)	260	72	6/36

PL Grzechotka
GB Ratchet handle
D Hebelumschaltknarre
RUS Ключ трещоточный

CZ Řehtačka
RO Antrenor cu clichet
H Racsni
E Llave de carraca

3/4"
19mm

500mm



No.	size / rozmiar	L (mm)	
53580	3/4" (19.0 mm)	500	10

PL Komplet nasadek z akcesoriami
GB Socket set
D Sechskantenschlüssel-Einsatz
RUS Набор торцевых головок

CZ Sada nástrčných klíčů a rážny
RO Trusă chei tubulare cu antrenor
H Dugökulcs készlet racsni hajtókarral
E Juego de boquillas con accesorios

16
PCS



⊗ 1/4" (6.3 mm) x 120 mm
⊗ 1/4" (6.3 mm) x 50 mm
⊗ 1/4" (6.3 mm): 4; 4.5; 5; 5.5; 6; 6.5; 7; 8; 9; 10; 11; 12; 13 mm
⊗ 1/4" (6.3 mm)

No.	pcs	
58160	16	20

PL Komplet nasadek z akcesoriami
GB Socket set
D Sechskantenschlüssel-Einsatz
RUS Набор торцевых головок

CZ Sada nástrčných klíčů a rážny
RO Trusă chei tubulare cu antrenor
H Dugökulcs készlet racsni hajtókarral
E Juego de boquillas con accesorios

20
PCS



⊗ 3/8" (9.5 mm) x 190 mm ⊗ 1/4" (6.3 mm) x 50 mm ⊗ 3/8" (9.5 mm) x 21 mm
⊗ 3/8" (9.5 mm) x 70 mm ⊗ 3/8" (9.5 mm) ⊗ 1/4" (6.3 mm) x 3/8" (9.5 mm) ⊗ 1/4" (6.3 mm):
4; 4.5; 5; 5.5; 6; 6.5; 7; 8; 9; 10; 11; 12 mm ⊗ 3/8" (9.5 mm): 13; 14; 17 mm

No.	pcs	
58210	20	10

PL Komplet nasadek z akcesoriami
 GB Socket set
 D Sechskantenschlüssel-Einsatz
 RUS Набор торцевых головок

CZ Sada nástrčných klíčů a ráčny
 RO Trusă chei tubulare cu antrenor
 H Dugókulcs készlet racsnis hajtókkal
 E Juego de boquillas con accesorios

24
PCS



⊕ 1/2" (12.7 mm) ⊕ 1/2" (12.7 mm) x 240 mm ⊕ 1/2" (12.7 mm): 8; 9; 10; 11; 12; 13; 14; 15; 16; 17; 18; 19; 20; 21; 22; 23; 24; 27; 30 mm ⊕ 1/2" (12.7 mm) x 21 mm ⊕ 1/2" (12.7 mm) x 250 mm ⊕ 1/2" (12.7 mm) x 125 mm

No.	pcs	📦
58240	24	5

PL Komplet nasadek z akcesoriami
 GB Socket set
 D Sechskantenschlüssel-Einsatz
 RUS Набор торцевых головок

CZ Sada nástrčných klíčů a ráčny
 RO Trusă chei tubulare cu antrenor
 H Dugókulcs készlet racsnis hajtókkal
 E Juego de boquillas con accesorios

24
PCS



⊕ 1/2" (12.7 mm) x 240 mm ⊕ 1/2" (12.7 mm): 10; 11; 12; 13; 14; 15; 16; 17; 18; 19; 20; 21; 22; 23; 24; 27; 30; 32 mm ⊕ 1/2" (12.7 mm) x 21 mm ⊕ 1/2" (12.7 mm) x 250 mm ⊕ 1/2" (12.7 mm) x 390 mm ⊕ 1/2" (12.7 mm) x 125 mm; 1/2" (12.7 mm) x 250 mm

No.	pcs	📦
58260	24	5

PL Komplet nasadek z akcesoriami
 GB Socket set
 D Sechskantenschlüssel-Einsatz
 RUS Набор торцевых головок

CZ Sada nástrčných klíčů a ráčny
 RO Trusă chei tubulare cu antrenor
 H Dugókulcs készlet racsnis hajtókkal
 E Juego de boquillas con accesorios

52
PCS



⊕ 1/4" (6.3 mm) x 125 mm; 1/2" (12.7 mm) x 250 mm ⊕ 1/4" (6.3 mm): 4; 4.5; 5; 5.5; 6; 7; 8; 9; 10; 11; 13 mm; 1/2" (12.7 mm): 10; 11; 12; 13; 14; 15; 16; 17; 18; 19; 22; 27; 30 mm ⊕ 1/2" (12.7 mm) x 21 mm ⊕ 1/4" (6.3 mm) x 110 mm; 1/2" (12.7 mm) x 250 mm ⊕ 1/4" (6.3 mm) x 6 mm ⊕ 1/4" (6.3 mm) x 75 mm; 1/2" (12.7 mm) x 125 mm; 1/2" (12.7 mm) x 250 mm; ⊕ 1/4" (6.3 mm) x 140 mm ⊕ 1/4" (6.3 mm): 1.5; 2; 2.5 mm ⊕ 3; 4; 5; 6; 7; 8 mm ⊕ 4; 5.5; 7 mm ⊕ PH1; PH2; PH3

No.	pcs	📦
58520	52	5

PL Komplet nasadek z akcesoriami
 GB Socket set
 D Sechskantenschlüssel-Einsatz
 RUS Набор торцевых головок

CZ Sada nástrčných klíčů a ráčny
 RO Trusă chei tubulare cu antrenor
 H Dugókulcs készlet racsnis hajtókkal
 E Juego de boquillas con accesorios

52
PCS

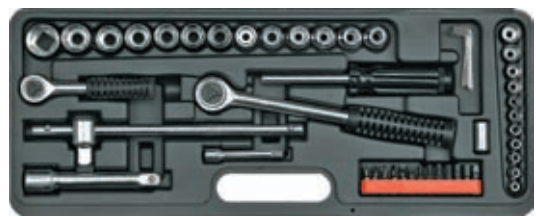

⊕ 1/4" (6.3 mm) x 125 mm; 1/2" (12.7 mm) x 250 mm ⊕ 1/4" (6.3 mm): 4; 4.5; 5; 5.5; 6; 7; 8; 9; 10; 11; 13 mm; 1/2" (12.7 mm): 8; 9; 10; 11; 12; 13; 14; 15; 16; 17; 18; 19; 20; 21; 22 mm ⊕ 1/2" (12.7 mm) x 250 mm ⊕ 1/4" (6.3 mm) x 6 mm ⊕ 1/4" (6.3 mm) x 70 mm; 1/2" (12.7 mm) x 120 mm; ⊕ 6 x 140 mm ⊕ 3; 4; 5; 6; 7; 8 mm ⊕ 4; 5.5; 7 mm ⊕ PH1; PH2; PH3 1.5; 2; 2.5; 3; 3.5; 4 mm

No.	pcs	📦
58530	52	5

PL Komplet nasadek z grzechotką
 GB Ratchet handle with socket set
 D Sechskant-Steckschlüssel-Satz
 RUS Набор насадок

CZ Sada nástrčných klíčů a ráčny
 RO Rotrușă chei tubulare cu antrenor
 H Dugókulcs készlet racsnis hajtókkal
 E Matraca con boquillas

11
PCS

72T

CrV



No.	mm	L (mm)	size / rozmiar	📦
58600	5; 6; 7; 8; 9; 10; 11; 12; 13; 14	150	1/4" (6.3 mm)	6/24
58602	10; 11; 12; 13; 14; 15; 17; 19; 22; 24	260	1/2" (12.7 mm)	12

PL Komplet nasadek z akcesoriami
 GB Socket set
 D Sechskantenschlüssel-Einsatz
 RUS Набор торцевых головок

CZ Sada nástrčných klíčů a ráčny
 RO Trusă chei tubulare cu antrenor
 H Dugókulcs készlet racsnis hajtókkal
 E Juego de boquillas con accesorios

14
PCS

3/4"
19mm



⊕ 3/4" (19.0 mm) x 495 mm ⊕ 3/4" (19.0 mm) x 100; 200 mm ⊕ 3/4" (19.0 mm): 22; 24; 27; 30; 32; 36; 38; 41; 46; 50 mm ⊕ 3/4" (19.0 mm) x 456 mm

No.	size / rozmiar	pcs	📦
58140	3/4" (19.0 mm)	14	2

PL Komplet nasadek z akcesoriami
 GB Socket set
 D Sechskantenschlüssel-Einsatz
 RUS Набор торцевых головок

CZ Sada nástrčných klíčů a ráčny
 RO Trusăchel tubulare cu antrenor
 H Dugókulcs készlet racsnis hajtókarral
 E Juego de boquillas con accesorios

20
 PCS

3/4"
 19 mm



⊕ 3/4" (19.0 mm) x 495 mm ⊕ 3/4" (19.0 mm) x 100; 200 mm ⊕ 3/4" (19.0 mm): 22; 24; 26; 27; 28; 30; 32; 34; 36; 38; 41; 42; 45; 46; 48; 50 mm ⊕ 3/4" (19.0 mm) x 456 mm

No.	pcs	Icon
58150	20	

PL Zestaw narzędziowy
 GB Tool set
 D Sechskant-Steckschlüssel-Satz
 RUS Набор инструмента
 CZ Sada nástrčných klíčů a ráčny
 RO Rotrusăchel tubulare cu antrenor
 H Dugókulcs készlet racsnis hajtókarral
 E Juego de herramientas

94
 PCS

CrV
 50BV30

CrV
 6150

AS-DRIVE

72T

1/2"
 12.5 mm

1/4"
 6.3 mm



⊕ 1/4" (6.3 mm): 4; 5; 5; 7 mm; CrV / CrV 50BV30: 5/16" (7.9 mm): 8; 10; 12 mm (L=30 mm); CrV ⊕ 1/4" (6.3 mm): PH1; PH2; CrV / CrV 50BV30: 5/16" (7.9 mm): PH3; PH4 (L=30 mm); CrV ⊕ 1/4" (6.3 mm): PZ1; PZ2; CrV / CrV 50BV30: 5/16" (7.9 mm): PZ3; PZ4 (L=30 mm); CrV ⊕ 1/4" (6.3 mm): T8; T10; T15; T20; T25; T30; CrV / CrV 50BV30: 5/16" (7.9 mm): T40; T45; T50; T55 (L=30 mm); CrV ⊕ 1/4" (6.3 mm) 3; 4; 5; 6 mm; CrV / CrV 50BV30: 5/16" (7.9 mm): 8; 10; 12; 14 mm (L=30 mm); CrV ⊕ 1/4" (6.3 mm): 4; 4.5; 5; 5.5; 6; 7; 8; 9; 10; 11; 12; 13; 14 mm (L=25 mm); CrV 50BV30: 1/2" (12.7 mm): 10; 11; 12; 13; 14; 15; 16; 17; 18; 19; 20; 21; 22; 23; 24 mm (L=38 mm); 27; 30; 32 mm (L=42 mm); CrV 50BV30 ⊕ 1/4" (6.3 mm): 6; 7; 8; 9; 10; 11; 12; 13 mm (L=50 mm); CrV 50BV30: 1/2" (12.7 mm): 14; 15; 17; 19 mm (L=76 mm) ⊕ 1/2" (12.7 mm): 16; 21 mm; CrV ⊕ 1/4" (6.3 mm): (114 mm); CrV ⊕ 1/4" (6.3 mm); 1/2" (12.7 mm); CrV ⊕ 1/4" (6.3 mm): (51, 102 mm); 1/2" (12.7 mm): (127, 254 mm); CrV ⊕ 3/8" (9.5 mm) (F) x 1/2" (12.7 mm) (M); CrV ⊕ 1/4" (6.3 mm): (152 mm); CrV ⊕ 1/4" (6.3 mm); 1/2" (12.7 mm); 72T; CrV ⊕ 1/4" (6.3 mm); (150 mm); CrV ⊕ 1/2" (12.7 mm); CrV ⊕ 1/4" (6.3 mm) x 1/4" (6.3 mm); CrV ⊕ 1.5; 2; 2.5 mm; CrV 6150



No.	pcs	Icon
58682	94	

Memo	
------	--

3

Screwdrivers & screwdriver bits **Wkrętaki i końcówki wkrętakowe**

Screwdrivers, 3 colour handle Wkrętaki, trój kolorowa rączka

22-23



Slotted screwdrivers

Wkrętaki płaskie..... 22

Phillips screwdrivers

Wkrętaki krzyżakowe..... 22

Pozidrive screwdrivers

Wkrętaki „Pozidrive”..... 22

Torx screwdrivers

Wkrętaki „Torx”..... 22

Screwdriver sets

Komplety wkrętaków..... 23

Ratchet screwdrivers

Wkrętaki z grzechotką..... 23

Screwdrivers HI-TEC & sets Wkrętaki HI-TEC i zestawy

23-25



Slotted screwdrivers

Wkrętaki płaskie..... 23

Phillips screwdrivers

Wkrętaki krzyżakowe..... 23

Torx screwdrivers

Wkrętaki „Torx”..... 24

Torx Security screwdrivers

Wkrętaki „Torx Security”..... 24

Screwdriver sets

Komplety wkrętaków..... 24

Special & impact screwdrivers Wkrętaki specjalne i udarowe

25-28

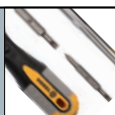

Two way screwdrivers

Wkrętaki dwustronne..... 25

Impact screwdrivers

Wkrętaki udarowe..... 27

Telescopic screwdrivers

Wkrętaki teleskopowe..... 27

T-bar screwdrivers

Wkrętaki T-gryf..... 28

Screwdriver sets Zestawy wkrętaków

28-29

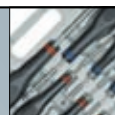

Precision screwdrivers sets Zestawy wkrętaków precyzyjnych

29

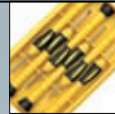

Screwdriver bits Kończówki wkrętakowe

30-32

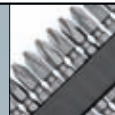

Screwdriver bit sets

Zestawy końcówek wkrętakowych..... 30

Screwdriver bit holders

Uchwyty do końcówek wkrętakowych..... 32

Nut setter sets

Zestawy nasadek magnetycznych do wkrętarek..... 32

Hex & Torx keys & sets Klucze imbusowe i zestawy

32-34



Hex keys

Klucze imbusowe „Hex”..... 32

Hex key sets

Zestawy kluczy imbusowych „Hex”..... 32

Torx & Torx Tamperproof key sets

Zestawy kluczy imbusowych „Torx” i „Torx Tamperproof”..... 34

PL Wkręłak płaski
GB Slotted screwdriver
D Schraubendreher schlitz
RUS Отвёртка

CZ Šroubovák
RO Şurubelniţă
H Csavarhúzó
E Destornillador



No.	mm	pcs. packing	
60912	2x75	12	96/384
60950	3x75	12	96/384
60951	3x100	12	96/384
60952	4x100	12	96/384
60913	4x150	12	96/384
60914	4x200	12	60/240
60915	5x38	12	60/240
60953	5x75	12	60/240
60954	5x100	12	60/240
60955	5x150	12	60/240
60916	5x200	12	36/144
60917	6x38	12	60/240
60956	6x100	12	36/144
60957	6x150	12	36/144
60958	6x200	12	36/144
60959	8x150	6	24/96
60918	8x250	6	24/96

PL Wkręłak krzyżakowy
GB Phillips screwdriver
D Kreuzschlitzschraubendreher
RUS Отвёртка

CZ Šroubovák křížový
RO Şurubelniţă în cruce
H Csavarhúzó kereszt
E Destornillador cruz



No.	mm	pcs. packing	
60920	PH00x65	12	96/384
60961	PH0x75	12	96/384
60962	PH0x100	12	96/384
60921	PH1x38	12	60/240
60963	PH1x75	12	60/240
60964	PH1x100	12	60/240
60965	PH1x150	12	60/240
60922	PH1x250	12	36/144
60923	PH2x38	12	60/240
60966	PH2x100	12	36/144
60967	PH2x150	12	36/144
60968	PH2x200	12	36/144
60924	PH2x250	12	36/144
60969	PH3x150	6	24/96

PL Wkręłak
GB Screwdriver
D Schraubendreher
RUS Отвёртка

CZ Šroubovák
RO Şurubelniţă
H Csavarhúzó
E Destornillador



No.	mm	pcs. packing	
60931	PZ0x75	12	96/384
60932	PZ0x100	12	96/384
60933	PZ1x75	12	60/240
60934	PZ1x100	12	60/240
60935	PZ1x200	12	36/144
60936	PZ2x100	12	36/144
60937	PZ2x150	12	36/144
60938	PZ2x200	12	36/144
60939	PZ3x150	6	24/96

PL Wkręłak
GB Screwdriver
D Schraubendreher
RUS Отвёртка

CZ Šroubovák
RO Şurubelniţă
H Csavarhúzó
E Destornillador



No.	mm	pcs. packing	
60880	T5x75	12	96/384
60881	T6x75	12	96/384
60882	T7x75	12	96/384
60883	T8x75	12	96/384
60884	T9x75	12	96/384
60885	T10x100	12	60/240
60886	T15x100	12	60/240
60887	T20x100	12	60/240
60888	T25x100	12	36/144
60889	T27x100	12	36/144
60890	T30x100	12	36/144
60891	T40x100	6	24/96

Screwdrivers & screwdriver bits / Wkrętaki i końcówki wkrętakowe

PL Komplet wkrętaków
GB Screwdriver set
D Schraubendrehersatz
RUS Набор отвёрток

CZ Zámečnické šroubováky
RO Şurubelnițe de lăcătușerie
H Lakatos csavarhúzó
E Juego de destornilladores

10 pcs

CrV 6150

3x75 5x100
6x100 6x150
8x150 mm

PH0x75 PH1x75
PH2x100 PH2x150
PH3x150 mm



No.	pcs	
60970	10	6/24

PL Zestaw wkrętak z grzechotką
GB Ratchet screwdriver set
D Ratschenschraubendreher-set mit einsätzen
RUS Набор головок с трещоткой
CZ Ráčňový kloubový šroubovák
RO Set surubelnița
H Dugókulcs és bit készlet csukló
E Juego con destornillador y carraca

29 PCS

CrV 6150

1/4" (6.3 mm),
5/16" (7.9 mm),
11/32" (8.7 mm),
3/8" (9.5 mm), 7/16" (11.1 mm),
1/2" (12.7 mm), 5, 6, 7, 8, 9,
10 mm

H4, H6

2xPH1
2xPH2, PH3

T10 T15 T20
T25 T30

1/4" (6.3 mm)
6 mm



No.	pcs	
60975	29	6/24

PL Zestaw wkrętak z grzechotką
GB Ratchet screwdriver set
D Ratschenschraubendreher-set mit einsätzen
RUS Набор головок с трещоткой
CZ Ráčňový kloubový šroubovák
RO Set surubelnița
H Dugókulcs és bit készlet csukló
E Juego con destornillador y carraca

22 PCS

1/4" (6.3 mm)
6 mm

4 5 6 7 8
9 10 11 12
13 mm

CrV

4, 5, 6mm

PH1
PH2, PH3

PZ1 PZ2

T15 T20



No.	pcs	
60976	22	12/24

PL Wkrętak płaski
GB Slotted screwdriver
D Schraubendreher schlitzz
RUS Отвёртка

CZ Šroubovák
RO Şurubelniță
H Csavarhúzó
E Destornillador

CrV



No.	mm	
61010	2.5x63	12/240
61020	3.2x75	12/240
61030	3.2x100	12/240
61040	3.2x150	12/240
61050	5.0x75	12/240
61060	5.0x100	12/240
61070	5.0x150	12/240
61080	5.0x200	12/240

PL Wkrętak płaski
GB Slotted screwdriver
D Schraubendreher schlitzz
RUS Отвёртка

CZ Šroubovák
RO Şurubelniță
H Csavarhúzó
E Destornillador

CrV



No.	mm	
61090	6.0x38	12/192

PL Wkrętak płaski
GB Slotted screwdriver
D Schraubendreher schlitzz
RUS Отвёртка

CZ Šroubovák
RO Şurubelniță
H Csavarhúzó
E Destornillador

CrV



No.	mm	
61100	6.0x100	12/144
61110	6.0x100	HEX 12/144
61120	6.0x150	12/144
61130	6.0x150	HEX 12/144
61140	6.0x200	12/144
61150	6.0x250	12/144
61160	8.0x150	6/72
61170	8.0x150	HEX 6/72

PL Wkrętak krzyżakowy
GB Phillips screwdriver
D Kreuzschlitzschraubendreher
RUS Отвёртка

CZ Šroubovák křížarý
RO Şurubelniță în cruce
H Csavarhúzó kereszt
E Destornillador cruz

CrV



No.	mm	
61290	PH2x38	12/288

PL Wkrętak krzyżakowy
GB Phillips screwdriver
D Kreuzschlitzschraubendreher
RUS Отвёртка

CZ Šroubovák křížřvý
RO Şurubelnişă în cruce
H Csavarhúzó kereszt
E Destornillador cruz



No.	mm	
61210	PH0x63	12/240
61220	PH0x75	12/240
61230	PH0x100	12/240
61240	PH0x150	12/240

PL Wkrętak krzyżakowy
GB Phillips screwdriver
D Kreuzschlitzschraubendreher
RUS Отвёртка

CZ Šroubovák křížřvý
RO Şurubelnişă în cruce
H Csavarhúzó kereszt
E Destornillador cruz



No.	mm	
61250	PH1x75	12/240
61260	PH1x100	12/240
61270	PH1x150	12/240
61280	PH1x200	12/240

PL Wkrętak krzyżakowy
GB Phillips screwdriver
D Kreuzschlitzschraubendreher
RUS Отвёртка

CZ Šroubovák křížřvý
RO Şurubelnişă în cruce
H Csavarhúzó kereszt
E Destornillador cruz



No.	mm	
61300	PH2x100	12/144
61310	PH2x100	HEX 12/144
61320	PH2x150	12/144
61330	PH2x150	HEX 12/144
61340	PH2x200	12/144
61350	PH2x250	12/144

PL Wkrętak krzyżakowy
GB Phillips screwdriver
D Kreuzschlitzschraubendreher
RUS Отвёртка

CZ Šroubovák křížřvý
RO Şurubelnişă în cruce
H Csavarhúzó kereszt
E Destornillador cruz



No.	mm	
61360	03x150	6/72
61370	03x150	HEX 6/72

PL Wkrętak
GB Screwdriver
D Schraubendreher
RUS Отвёртка

CZ Šroubovák
RO Şurubelnişă
H Csavarhúzó
E Destornillador



No.	mm	
61375	T5x75	12/240
61376	T6x75	12/240
61377	T7x75	12/240
61378	T8x75	12/240
61379	T9x75	12/240

PL Wkrętak
GB Screwdriver
D Schraubendreher
RUS Отвёртка

CZ Šroubovák
RO Şurubelnişă
H Csavarhúzó
E Destornillador



No.	mm	
61380	T10x100	12/240
61381	T15x100	12/240
61382	T20x100	12/240
61383	T25x100	12/144
61384	T27x100	12/144
61385	T30x100	12/144
61386	T40x100	12/144

PL Wkrętak
GB Screwdriver
D Schraubendreher
RUS Отвёртка

CZ Šroubovák
RO Şurubelnişă
H Csavarhúzó
E Destornillador



No.	mm	
61392	T10x200	12/240
61393	T15x200	12/240
61394	T20x200	12/240
61395	T25x200	12/144

PL Komplet wkrętaków
GB Screwdriver set
D Schraubendrehersatz
RUS Набор отвёрток
CZ Zámešnické šroubováky
RO Şurubelnişă de lăcătuseerie
H Lakatos csavarhúzó
E Juego de destornilladores

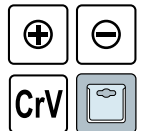

No.	pcs	packing:	
61550	5		5/20
61560	6		6/24
61580	8		6/12

Screwdrivers & screwdriver bits / Wkrętaki i końcówki wkrętek

PL Komplet wkrętek
GB Screwdriver set
D Schraubendrehersatz
RUS Набор отвёрток

CZ Zámečnické šroubováky
RO Şurubelniţe de lăcătuşerie
H Lakatos csavarhúzó
E Juego de destornilladores

8 PCS

+

CrV

+

VOREL

No.	pcs	
61590	8	5/20

PL Komplet wkrętek
GB Screwdriver set
D Schraubendrehersatz
RUS Набор отвёрток

CZ Zámečnické šroubováky
RO Şurubelniţe de lăcătuşerie
H Lakatos csavarhúzó
E Juego de destornilladores

10 PCS

+

CrV

+

VOREL

No.	pcs	
61600	10	6/12

PL Wkrętak
GB Screwdriver
D Umsteckschraubendreher
RUS Отвёртка

CZ Šroubovák
RO Şurubelniţă
H Csavarhúzó, lapos-kereszt
E Destornillador

5.0 mm

6.0 mm

PH1

PH2

CrV

MAGNETIC

+

-

X

VOREL

No.	pcs	
61640	2	8/96

PL Wkrętak płasko-krzyżakowy
GB Slotted - phillips screwdriver
D Umsteckschraubendreher
RUS Отвёртка реверсная

CZ Plochý a křížový šroubovák
RO Şurubelniţă dublu cap: plata + cruce
H Csavarhúzó, lapos-kereszt
E Destornillador plano-cruz

+

-

X

VOREL

No.	type	
60910	R-1	30

PL Wkrętak płasko-krzyżakowy
GB Slotted - phillips screwdriver
D Umsteckschraubendreher
RUS Отвёртка реверсная

CZ Plochý a křížový šroubovák
RO Şurubelniţă dublu cap: plata + cruce
H Csavarhúzó, lapos-kereszt
E Destornillador plano-cruz

+

-

X

VOREL

No.	type	
60930	R-3	40

PL Wkrętak dwustronny
GB Two-way screwdriver
D Umsteckschraubendreher
RUS Отвёртка реверсная

CZ Dvoustranný šroubovák
RO Şurubelniţă dublu capăt
H Kétoldalas csavarhúzó
E Destornillador de dos caras

+

-

+

VOREL

No.		
64940		25/100

PL Wkrętak dwustronny
GB Two-way screwdriver
D Umsteckschraubendreher
RUS Отвёртка реверсная

CZ Dvoustranný šroubovák
RO Şurubelniţă dublu capăt
H Kétoldalas csavarhúzó
E Destornillador de dos caras

+

-

+

VOREL

No.		
64950		25/100

PL Wkrętak dwustronny
GB Two-way screwdriver
D Schraubendreher mit doppelschlitz
RUS Отвёртка двухсторонная

CZ Dvoustranný šroubovák
RO Şurubelniţă dublu capăt
H Kétoldalas csavarhúzó
E Destornillador de dos caras

4 PCS

CrV 6150

+

-

+

5 mm x PH1

6 mm x PH2

6 x 8 mm

VOREL

No.	pcs	
64654	4	12/72

PL Komplet wkrętlaków
GB Screwdriver set
D Schraubendrehersatz
RUS Набор отвёрток

CZ Zámečnické šroubováky
RO Şurubelnițe de lăcătușerie
H Lakatos csavarhúzó
E Juego de destornilladores

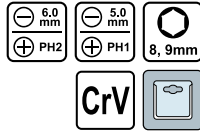

No.	bits	box
64951	12/72	

PL Wkrętlak
GB Screwdriver
D Schraubendreher
RUS Отвёртка

CZ Šroubovák
RO Şurubelniță
H Csavarhúzó
E Destornillador

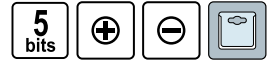

No.	bits	box
65040	5	25/100

PL Wkrętlak
GB Screwdriver
D Schraubendreher
RUS Отвёртка с битами

CZ Šroubovák
RO Şurubelniță
H Csavarhúzó
E Destornillador

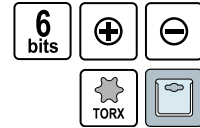

No.	bits	box
65041	6	25/100

PL Wkrętlak wyginany
GB Screwdriver
D Schraubendreher
RUS Отвёртка гибкая

CZ Ohybaný šroubovák
RO Şurubelniță flexibilă + bituri
H Hajlítószerű csavarbehajtó
E Destornillador con extensión flexible



No.	bits	box
65080	7	12/48

PL Zestaw wkrętlak z grzechotką
GB Ratchet screwdriver set
D Ratschenschraubendreher-set mit einsätzen
RUS Набор головок с трещоткой

CZ Ráčňový kloubový šroubovák
RO Set surubelnița
H Dugókulcs és bit készlet csukló
E Juego con destornillador y carraca



No.	pcs	box
65170	41	15/30

PL Zestaw wkrętlak z grzechotką i bitami
GB Ratchet screwdriver set with bits
D Schraubendreher mit ratche
RUS Отвёртка с трещоткой

CZ Šroubovák z fehtačkou
RO Şurubelniță cu clichet
H Racsnis csavarbehajtó
E Juego con destornillador y carraca

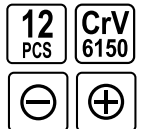

1/4" (6,3 mm): 3,5, 4, 5,5 mm (L=25 mm)
1/4" (6,3 mm): PH0, PH1, PH2, PH3 (L=25 mm)
1/4" (6,3 mm): T20, T25 (L=25 mm)
1/4" (6,3 mm): P20, P21, P22 (L=25 mm)



No.	pcs	box
64658	12	12/72

PL Wkrętlak z grzechotką i wymiennymi końcówkami
GB Ratchet screwdriver set with bits
D Schraubendreher mit ratche
RUS Отвёртка с трещоткой
CZ Šroubovák z fehtačkou
RO Şurubelniță cu clichet
H Racsnis csavarbehajtó
E Juego con destornillador y carraca



No.	pcs	box
64651	14	6/36

1/4" (6,3 mm): PH1, PH2 (L=25 mm)
1/4" (6,3 mm): T15, T20 (L=25 mm)
1/4" (6,3 mm): 5, 6 mm (L=25 mm)
5, 6, 7, 8, 10, 12, 13 mm

Screwdrivers & screwdriver bits / Wkrętaki i końcówki wkrętakowe

PL Wkrętak z grzechotką i wymiennymi końcówkami
GB Ratchet screwdriver set with bits
D Schraubendreher mit ratche
RUS Отвертка с трещеткой
CZ Šroubovák z řehlačkou
RO Șurubelniță cu clișet
H Racsnis csavarbehajtó
E Juego con destornillador y carraca

31 PCS **CrV 6150** **HRC 50-54**

1/4" (6.3 mm): 3, 3.5, 4, 5, 5.5, 6 mm (L=25 mm)
 1/4" (6.3 mm): PH0, PH1, PH2, PH3 (L=25 mm)
 1/4" (6.3 mm): T10, T15, T20, T25, T27, T30 (L=25 mm)
 1/4" (6.3 mm): P20, P21, P22, P23 (L=25 mm)
 1/4" (6.3 mm): 2, 2.5, 3, 4, 5, 6 mm (L=25 mm)
 1/4" (6.3 mm): S0, S1 (L=25 mm)
 2,0 x 50 mm
 PH00 x 50 mm

No.	pcs	box
64655	31	6/36

PL Wkrętak z grzechotką i wymiennymi końcówkami
GB Ratchet screwdriver set with bits
D Schraubendreher mit ratche
RUS Отвертка с трещеткой
CZ Šroubovák z řehlačkou
RO Șurubelniță cu clișet
H Racsnis csavarbehajtó
E Juego con destornillador y carraca

36 PCS **CrV 6150**

1/4" (6.3 mm): 3, 3.5, 4, 5, 5.5 mm (L=25 mm)
 1/4" (6.3 mm): PH0, PH1, PH2, PH3 (L=25 mm)
 1/4" (6.3 mm): T10, T15, T20, T25, T27, T30 (L=25 mm)
 1/4" (6.3 mm): P29, PZ1, PZ2, PZ3 (L=25 mm)
 1/4" (6.3 mm): 3, 4 mm (L=25 mm)
 1/4" (6.3 mm): 4, 4.5, 5, 6, 7, 8, 9, 10, 11, 12, 13 mm
 50 mm

No.	pcs	box
64660	36	6/24

PL Wkrętak z grzechotką i wymiennymi końcówkami
GB Ratchet screwdriver set with bits
D Schraubendreher mit ratche
RUS Отвертка с трещеткой
CZ Šroubovák z řehlačkou
RO Șurubelniță cu clișet
H Racsnis csavarbehajtó
E Juego con destornillador y carraca

46 PCS **CrV 6150**

1/4" (6.3 mm): 2, 3, 3.5, 4, 4.5, 5.5, 6.5, 7 mm (L=30 mm)
 1/4" (6.3 mm): PH0, PH1, PH2, PH3 (L=30 mm)
 1/4" (6.3 mm): T10, T15, T20, T25, T27, T30 (L=30 mm)
 1/4" (6.3 mm): P20, P21, P22, P23 (L=30 mm)
 1/4" (6.3 mm): 2, 2.5, 3, 4, 5, 6 (L=30 mm)
 1/4" (6.3 mm): S0, S1, S2, S3 (L=30 mm)
 1/4" (6.3 mm): 4, 5, 5.5, 6, 7, 8, 9, 10, 11, 12, 13 mm
 1/4" (6.3 mm)

No.	pcs	box
64657	46	6/24

PL Wkrętak udarowy
GB Impact screwdriver
D Schlagschrauber
RUS Отвертка ударная

CZ Narazový šroubovák kovový
RO Șurubelniță metalică cu percutor
H Csavarbehajtó, ütő üzemmóddal
E Destornillador de percusión

4 bits

No.	bits	box
65120	4	25

PL Wkrętak udarowy
GB Impact screwdriver
D Schlagschrauber
RUS Отвертка ударная

CZ Narazový šroubovák kovový
RO Șurubelniță metalică cu percutor
H Csavarbehajtó, ütő üzemmóddal
E Destornillador de percusión

6 bits **CrV**

No.	bits	box
65122	6	20

PL Wkrętak magnetyczny, teleskopowy
GB Telescopic screwdriver, magnetic
D Schraubendreher
RUS Отвертка магнетическая

CZ Magnetický řoubavák -teleskop
RO Șurubelniță telescopica cu magnet
H Mágneses csavarbehajtó-teleszkop
E Destornillador magnético-telescop.

6 bits

No.	bits	box
65045	6	25/100

PL Wkrętak z teleskopowym chwytakiem magnetycznym
 GB Screwdriver with magnetic telescopic pick-up tool
 D Schraubendreher mit auschiebbaren magnetischen halter
 RUS Отвёртка магнетическая
 CZ Magnetický řoubáček -teleskop
 RO Şurubelniţă cu magnet - telescop
 H Mágneses csavarbehajtó-teleszkop
 E Destornillador magnético-telescop

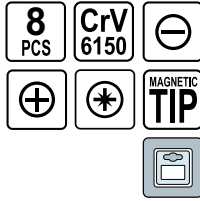

- 1/4" (6,3 mm): 3, 4, 5, 5,5 mm (L=25 mm)
- 1/4" (6,3 mm): PH1, PH2 (L=25 mm)
- 1/4" (6,3 mm): PZ1, PZ2 (L=25 mm)



No.	pcs	
64650	8	12/72

PL Wkrętak T-gryf
 GB T-bar screwdriver
 D T-griff schraubendrehersatz
 RUS Отвёртка Т-образная

CZ Šroubovák T-gryf
 RO Set surubelnița tip „T”
 H Csavarbehajtó, T-gyrf
 E Destornillador T-grifo

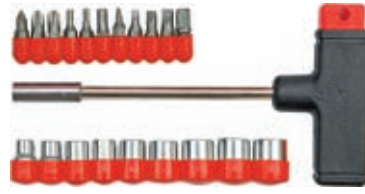

No.	bits	
65100	20	10/80

PL Wkrętak T-gryf
 GB T-bar screwdriver set
 D T-griff schraubendrehersatz
 RUS Отвёртка Т-образная
 CZ Šroubovák T-gryf
 RO Set surubelnița tip „T”
 H Csavarbehajtó, T-gyrf
 E Destornillador T-grifo

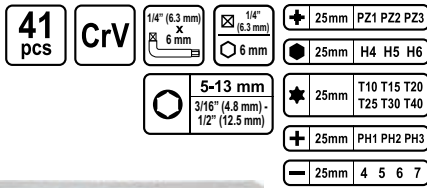

No.	pcs	
65150	41	24

PL Komplet wkrętaków
 GB Screwdriver set
 D Schraubendrehersatz
 RUS Набор отвёрток

CZ Zámečnické šroubováky
 RO Şurubelnițe de lăcătușerie
 H Lakatos csavarhőző
 E Juego de destornilladores



No.	pcs	
62158	5	5/30

PL Komplet wkrętaków
 GB Screwdriver set
 D Schraubendrehersatz
 RUS Набор отвёрток

CZ Zámečnické šroubováky
 RO Şurubelnițe de lăcătușerie
 H Lakatos csavarhőző
 E Juego de destornilladores

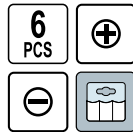

No.	pcs	
64060	6	20/60

PL Komplet wkrętaków
 GB Screwdriver set
 D Schraubendrehersatz
 RUS Набор отвёрток

CZ Zámečnické šroubováky
 RO Şurubelnițe de lăcătușerie
 H Lakatos csavarhőző
 E Juego de destornilladores



No.	pcs	
64050	6	20/80

PL Komplet wkrętaków
 GB Screwdriver set
 D Schraubendrehersatz
 RUS Набор отвёрток

CZ Zámečnické šroubováky
 RO Şurubelnițe de lăcătușerie
 H Lakatos csavarhőző
 E Juego de destornilladores



No.	pcs	
64070	7	20/80

PL Komplet wkrętaków
 GB Screwdriver set
 D Schraubendrehersatz
 RUS Набор отвёрток

CZ Zámečnické šroubováky
 RO Şurubelnițe de lăcătușerie
 H Lakatos csavarhőző
 E Juego de destornilladores



No.	pcs	
64090	6	10/60

Screwdrivers & screwdriver bits / Wkrętaki i końcówki wkrętaskowe

PL Zestaw końcówek śrubokrętowych + uchwyt
 GB Precision screwdriver bits + bit holder
 D Schraubendreherbitsatz + Bithalter
 RUS Набор специальных битов + держател
 CZ 6 DĚD EMRY CLAI N
 RO Truse bit + capete șurubel niță
 H Bittkészlet + szár
 E Juego de llaves especiales + mandril

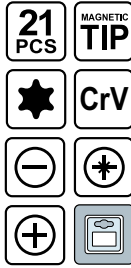

No.	pcs	box
64370	21	12/60

PL Zestaw końcówek śrubokrętowych + uchwyt
 GB Precision screwdriver bits + bit holder
 D Schraubendreherbitsatz + Bithalter
 RUS Набор специальных битов + держател
 CZ 6 DĚD EMRY CLAI N
 RO Truse bit + capete șurubel niță
 H Bittkészlet + szár
 E Juego de llaves especiales + mandril

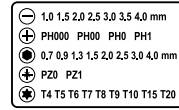

No.	pcs	box
64371	32	10/20

PL Zestaw wkrętasków precyzyjnych
 GB Precision screwdriver set
 D Präzisions-feinmechanikersatz
 RUS Набор прецизионных отвёрток

CZ Šroubováky sada
 RO Set șurubelnițe
 H Órás csavarhúzó készlet
 E Destornilladores precisos

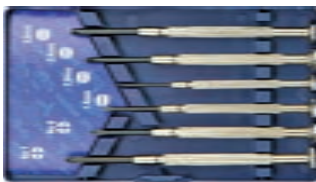
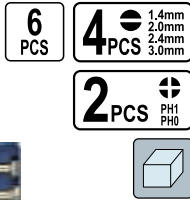

No.	pcs	box
64310	6	20/100

PL Zestaw wkrętasków precyzyjnych
 GB Precision screwdriver set
 D Präzisions-feinmechanikersatz
 RUS Набор прецизионных отвёрток
 CZ Šroubováky sada
 RO Set șurubelnițe
 H Órás csavarhúzó készlet
 E Destornilladores precisos



No.	pcs	box
64330	11	25/100

PL Zestaw wkrętasków precyzyjnych
 GB Precision screwdriver set
 D Präzisions-feinmechanikersatz
 RUS Набор прецизионных отвёрток

CZ Šroubováky sada
 RO Set șurubelnițe
 H Órás csavarhúzó készlet
 E Destornilladores precisos

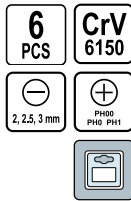

No.	pcs	box
64380	6	10/50

PL Zestaw końcówek śrubokrętowych + uchwyt
 GB Precision screwdriver bits + bit holder
 D Schraubendreherbitsatz + Bithalter
 RUS Набор специальных битов + держател
 CZ 6 DĚD EMRY CLAI N
 RO Truse bit + capete șurubel niță
 H Bittkészlet + szár
 E Juego de llaves especiales + mandril

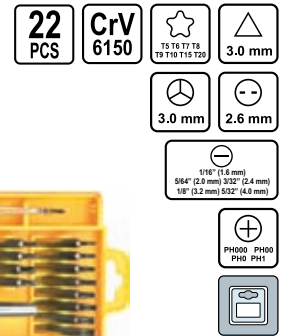

No.	pcs	box
64395	22	10/50

PL Zestaw końcówek śrubokrętowych + uchwyt
 GB Precision screwdriver bits + bit holder
 D Schraubendreherbitsatz + Bithalter
 RUS Набор специальных битов + держател
 CZ 6 DĚD EMRY CLAI N
 RO Truse bit + capete șurubel niță
 H Bittkészlet + szár
 E Juego de llaves especiales + mandril

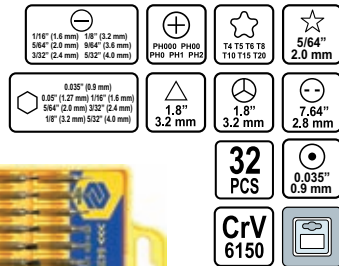

No.	pcs	box
64396	32	10/50

PL Wkrętaki precyzyjne
 GB Precision screwdriver set
 D Präzisions-Schraubendreherersatz
 RUS Отвёртки для точных работ
 CZ Precizní šroubováky
 RO Șurubelnițe precise
 H Precíziós csavarhúzó
 E Destornilladores precisos

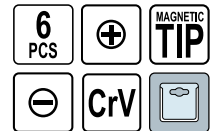

No.	pcs	box
64553	6	10/60
64554	6	10/60

PL Zestaw końcówek śrubokrętowych
 GB Screwdriver bit set
 D Schraubendreherbitsatz
 RUS Набор битов
 CZ Sada bitů
 RO Truse bit
 H Bitkészlet
 E Puntas de destornilladora

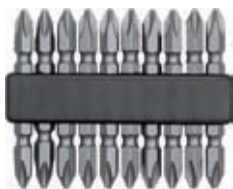
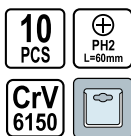

No.	pcs	
65700	10	25/100

PL Zestaw końcówek śrubokrętowych
 GB Screwdriver bit set
 D Schraubendreherbitsatz
 RUS Набор битов

CZ Sada bitů
 RO Truse bit
 H Bitkészlet
 E Puntas de destornilladora



No.	mm	pcs packing	
65520	PZ2x25	10	25/200

PL Zestaw końcówek śrubokrętowych
 GB Screwdriver bit set
 D Schraubendreherbitsatz
 RUS Набор битов
 CZ Sada bitů
 RO Truse bit
 H Bitkészlet
 E Puntas de destornilladora



No.	mm	pcs packing	
65610	PH1x25	10	25/200
65620	PH1x50	10	25/100
65630	PH2x25	10	25/200
65640	PH2x50	10	25/100
65650	PH2x75	10	25/100

PL Końcówki śrubokrętowe do gipsów
 GB Screwdriver bit set
 D Phillips-Bits mit Schutz PH2
 RUS Насадки для завинчивания по гипсокартону

CZ Koncovky šroubovavkové na sádro
 RO Capete pt. șurubelniță
 H Csavarhúzóvégek gipszhez
 E Puntas con limitador ph2 escayola



No.	pcs packing	
65800	2	12/144

PL Zestaw końcówek śrubokrętowych
 GB Screwdriver bit set
 D Schraubendreherbitsatz
 RUS Набор битов
 CZ Sada bitů
 RO Truse bit
 H Bitkészlet
 E Puntas de destornilladora

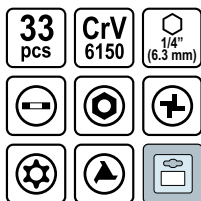

No.	pcs	
66330	33	12/60

PL Zestaw końcówek śrubokrętowych
 GB Screwdriver bit set
 D Schraubendreherbitsatz
 RUS Набор специальных битов

CZ Sada bitů
 RO Truse bit
 H Bitkészlet
 E Juego de llaves especiales

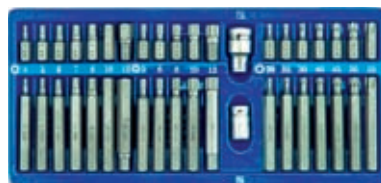
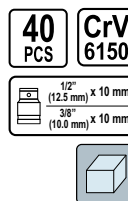

⚙ 30 mm: T20; T25; T30; T40; T45; T50; T55, 75 mm: T20; T25; T30; T40; T45; T50; T55, ⚙ 30 mm: H4; H5; H6; H7; H8; H10; H12, 75 mm: H4; H5; H6; H7; H8; H10; H12, ⚙ 30 mm: M5; M6; M8; M10; M12, 75 mm: M5; M6; M8; M10; M12

No.	pcs	
66400	40	10

PL Zestaw końcówek śrubokrętowych
 GB Screwdriver bit set
 D Schraubendreherbitsatz
 RUS Набор специальных битов

CZ Sada bitů
 RO Truse bit
 H Bitkészlet
 E Juego de llaves especiales

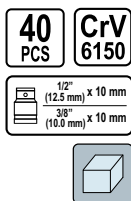

⚙ 30 mm: T20; T25; T30; T40; T45; T50; T55, 75 mm: T20; T25; T30; T40; T45; T50; T55, ⚙ 30 mm: H4; H5; H6; H7; H8; H10; H12, 75 mm: H4; H5; H6; H7; H8; H10; H12, ⚙ 30 mm: M5; M6; M8; M10; M12, 75 mm: M5; M6; M8; M10; M12

No.	pcs	
66410	40	10

PL Zestaw końcówek śrubokrętowych
 GB Screwdriver bit set
 D Schraubendreherbitsatz
 RUS Набор специальных битов

CZ Sada bitů
 RO Truse bit
 H Bitkészlet
 E Juego de llaves especiales



No.	pcs	
66570	7	24/72

Screwdrivers & screwdriver bits / Wkrętaki i końcówki wkrętakowe

PL Zestaw końcówek śrubokrętowych
 GB Screwdriver bit set
 D Schraubendreherbitsatz
 RUS Набор специальных битов

CZ Sada bitů
 RO Truse bit
 H Bitkészlet
 E Juego de llaves especiales

15 PCS TORX CrV 6150

1/2" (12.5 mm) x 10 mm



VOREL

30 mm: T20; T25; T30; T40; T45; T50; T55, 75 mm: T20; T25; T30; T40; T45; T50; T55

No.	pcs	
66580	15	20

PL Zestaw końcówek śrubokrętowych
 GB Screwdriver bit set
 D Schraubendreherbitsatz
 RUS Набор специальных битов

CZ Sada bitů
 RO Truse bit
 H Bitkészlet
 E Juego de llaves especiales

7 PCS H4 H5 H6 H8 H10 H12 30mm CrV 6150

1/2" (12.5 mm) x 10 mm 10mm



VOREL

No.	pcs	
66710	7	24/72

PL Zestaw końcówek śrubokrętowych
 GB Screwdriver bit set
 D Schraubendreherbitsatz
 RUS Набор специальных битов

CZ Sada bitů
 RO Truse bit
 H Bitkészlet
 E Juego de llaves especiales

15 PCS HEX 1/2" (12.5 mm) x 10 mm CrV 6150

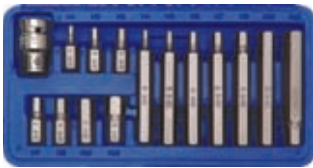

VOREL

30 mm: H4; H5; H6; H7; H8; H10; H12, 75 mm: H4; H5; H6; H7; H8; H10; H12

No.	pcs	
66720	15	20

PL Zestaw końcówek śrubokrętowych
 GB Screwdriver bit set
 D Schraubendreherbitsatz
 RUS Набор специальных битов

CZ Sada bitů
 RO Truse bit
 H Bitkészlet
 E Juego de llaves especiales

6 PCS M5, M6, M8, M10, M12 30mm CrV 6150

1/2" (12.5 mm) x 10 mm 10mm



VOREL

No.	pcs	
66760	6	24/72

PL Zestaw końcówek śrubokrętowych
 GB Screwdriver bit set
 D Schraubendreherbitsatz
 RUS Набор специальных битов

CZ Sada bitů
 RO Truse bit
 H Bitkészlet
 E Juego de llaves especiales

11 PCS SPLINE 1/2" (12.5 mm) x 10 mm CrV 6150

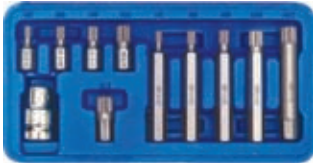

VOREL

30 mm: M5; M6; M8; M10; M12, 75 mm: M5; M6; M8; M10; M12

No.	pcs	
66770	11	20

PL Zestaw końcówek śrubokrętowych
 GB Screwdriver bit set
 D Schraubendreherbitsatz
 RUS Набор специальных битов

CZ Sada bitů
 RO Truse bit
 H Bitkészlet
 E Juego de llaves especiales

7 PCS



VOREL

No.	pcs	
66080	7	20/200

PL Zestaw końcówek śrubokrętowych
 GB Screwdriver bit set
 D Schraubendreherbitsatz
 RUS Набор специальных битов

CZ Sada bitů
 RO Truse bit
 H Bitkészlet
 E Juego de llaves especiales

10 PCS



VOREL

No.	pcs	
66112	10	25/100

PL Zestaw końcówek śrubokrętowych
 GB Screwdriver bit set
 D Schraubendreherbitsatz
 RUS Набор специальных битов

CZ Sada bitů
 RO Truse bit
 H Bitkészlet
 E Juego de llaves especiales

20 PCS HEX TORX



VOREL

No.	pcs	
66210	20	12/48

3

PL Zestaw końcówek śrubokrętowych
 GB Screwdriver bit set
 D Schraubendreherbitsatz
 RUS Набор специальных бит

CZ Sada bitů
 RO Truse bit
 H Bitkészlet
 E Juego de llaves especiales



No.	pcs	
66200	20	12/48

PL Uchwyt do końcówek śrubokrętowych
 GB Screwdriver bit holder
 D Bithalter
 RUS Магнитный держатель

CZ Uchyt na koncovky šroubováků
 RO Capete șurubelniță
 H Szár a csavarhúzóvégekhez
 E Mandril para puntas



No.	pcs
65850	30/300

PL Komplet końcówek nasadowych
 GB Screwdriver bit set
 D Bit-Steckschlüsselsatz
 RUS Головки со вставкой

CZ Sada nasádných koncovek
 RO Set de capete tubulare
 H Csőkulcskészlet
 E Juego de puntas de calar



No.	pcs	
66113	8	25/50

PL Klucz sześciokątny
 GB Hex key
 D Sechskant-Stiftschlüssel
 RUS Шестигранник

CZ Imbusový klíč
 RO Chele imbus
 H Imbilsz kulcs
 E Llave hexagonal



PL Zestaw kluczy imbusowych
 GB Hex key set
 D Sechskant-Stiftschlüsselsatz
 RUS Набор шестигранников

CZ Imbusové klíče
 RO Chele imbus
 H Imbilsz kulcs
 E Juego de llaves hex



No.	mm	pcs	
56380	2-10	8	20/100
56390	1.5-10	10	20/100

No.	mm	
56040	4	1000/2000
56050	5	400/800
56060	6	400/800
56070	7	300/600
56080	8	200/400
56100	10	100/200
56120	12	50/100
56130	13	50/100
56140	14	50/100
56170	17	25/50

PL Zestaw kluczy imbusowych
 GB Hex key set
 D Sechskant-Stiftschlüsselsatz
 RUS Набор шестигранников

CZ Imbusové klíče
 RO Chele imbus
 H Imbilsz kulcs
 E Juego de llaves hex



No.	mm	pcs	
56391	1.5-10	10	20/100
56392	2-10	8	20/100

PL Zestaw kluczy imbusowych
 GB Hex key set
 D Sechskant-Stiftschlüsselsatz
 RUS Набор шестигранников

CZ Imbusové klíče
 RO Chele imbus
 H Imbilsz kulcs
 E Juego de llaves hex



No.	mm	pcs	
56393	1.5; 2; 2.5; 3; 4; 5; 5.5; 6; 8; 10	10	10/60

Screwdrivers & screwdriver bits / Wkrętaki i końcówki wkrętakowe

PL Zestaw kluczy imbusowych
GB Hex key set
D Sechskant-Stiftschluselsatz
RUS Набор шестигранных

CZ Imbusové klíče
RO Chel imbus
H Imbisz kulcs
E Juego de llaves hex

10
PCS
HEX



No.	mm	pcs	
56400	2-14	10	20/40

PL Zestaw kluczy imbusowych
GB Hex key set
D Sechskant-Stiftschluselsatz
RUS Набор шестигранных

CZ Imbusové klíče
RO Chel imbus
H Imbisz kulcs
E Juego de llaves hex

7
PCS
HEX
25/100



No.	mm	pcs	
56470	2.5; 3; 4; 5; 6; 8; 10	7	20/40

PL Zestaw kluczy imbusowych
GB Hex key set
D Sechskant-Stiftschluselsatz
RUS Набор шестигранных

CZ Imbusové klíče
RO Chel imbus
H Imbisz kulcs
E Juego de llaves hex

8
PCS
HEX
25/100



No.	mm	pcs	
56473	1.5; 2; 2.5; 3; 4; 5; 6; 8	8	10/60

PL Zestaw kluczy imbusowych
GB Hex key set
D Sechskant-Stiftschluselsatz
RUS Набор шестигранных

CZ Imbusové klíče
RO Chel imbus
H Imbisz kulcs
E Juego de llaves hex

9
PCS
HEX
25/100



No.	mm	pcs	
56475	2.5; 3; 4; 5; 5.5; 6; 7; 8; 10	9	10/60

PL Zestaw kluczy imbusowych
GB Hex key set
D Sechskant-Stiftschluselsatz
RUS Набор шестигранных

CZ Imbusové klíče
RO Chel imbus
H Imbisz kulcs
E Juego de llaves hex

9
PCS
HEX
25/100



No.	mm	pcs	
56477	2; 2.5; 3; 4; 5; 5.5; 6; 8; 10	9	10/60

PL Zestaw kluczy imbusowych
GB Hex key set
D Sechskant-Stiftschluselsatz
RUS Набор шестигранных

CZ Imbusové klíče
RO Chel imbus
H Imbisz kulcs
E Juego de llaves hex

7
PCS
HEX
25/100



No.	mm	pcs	
56501	1.5; 2; 2.5; 3; 4; 5; 6	7	25/100

PL Zestaw kluczy imbusowych
GB Hex key set
D Sechskant-Stiftschluselsatz
RUS Набор шестигранных

CZ Imbusové klíče
RO Chel imbus
H Imbisz kulcs
E Juego de llaves hex

8
PCS
HEX
25/100



No.	mm	pcs	
56505	1.5; 2; 2.5; 3; 4; 5; 6; 8	8	25/100

PL Zestaw kluczy imbusowych
GB Hex key set
D Sechskant-Stiftschluselsatz
RUS Набор шестигранных

CZ Imbusové klíče
RO Chel imbus
H Imbisz kulcs
E Juego de llaves hex

8
PCS
HEX
25/100



No.	mm	pcs	
56506	1.5; 2; 2.5; 3; 4; 5; 6; 8	8	25/100

Memo

4

Pliers & pipe wrenches **Szczypce i klucze do rur**

Pliers, heavy duty blue handle
Szczypce, uchwyt niebieski



38

Combination pliers Szcypce uniwersalne.....	38
Side cutting pliers Szcypce tnące, boczne.....	38
Long nose pliers Szcypce wydłużone, proste.....	38
Bent nose pliers Szcypce wydłużone, wygięte.....	38

Pliers, 2 colour handle
Szczypce, dwukolorowa rączka



38-39

Combination pliers Szcypce uniwersalne.....	38
Side cutting pliers Szcypce tnące, boczne.....	38
Long nose pliers Szcypce wydłużone, proste.....	38
Bent nose pliers Szcypce wydłużone, wygięte.....	38
Round nose pliers Szcypce okrągłe.....	39
Wire stripping pliers Szcypce do ściągania izolacji.....	39
End cutting pliers Szcypce tnące, czołowe.....	39
Water pump pliers Szcypce nastawne.....	39

Chrome plated pliers
Szczypce chromowane



39

Water pump pliers Szcypce nastawne.....	39
---	----

Pincers & pliers
Szczypce i obcęgi



39-40

End cutting pliers Szcypce tnące, czołowe.....	39
Carpenter's pincers Obcęgi.....	39
Tower pincers Szcypce tynkarskie.....	40

Profile connection pliers
Szczypce do łączenia profili



40

Pliers „Juco”
Szczypce „Juco”



40

Combination pliers Szcypce uniwersalne.....	40
Side cutting pliers Szcypce tnące, boczne.....	40

Mini pliers
Szczypce „Mini”



40-41

Combination pliers Szcypce uniwersalne.....	40
Side cutting pliers Szcypce tnące, boczne.....	40
Long nose pliers Szcypce wydłużone, proste.....	40
Bent nose pliers Szcypce wydłużone, wygięte.....	41
Flat nose pliers Szcypce płaskie.....	41
Round nose pliers Szcypce okrągłe.....	41
End cutting pliers Szcypce tnące, czołowe.....	41
Mini pliers sets Zestawy szczyptic „Mini”.....	41

Circlip pliers
Szczypce Segera



41-43

Lock grip pliers
Szczypce zaciskowe



43

Water pump pliers
Szczypce nastawne



43

Pipe wrenches
Klucze do rur



44

Pipe wrenches Stillson type Klucze do rur typu Stillson.....	44
Adjustable pipe wrenches Klucze do rur nastawne.....	44
Adjustable wrenches Klucze nastawne francuskie.....	44

Chain pipe wrenches
Klucze do rur łańcuchowe



45

4

PL Szczypce uniwersalne
GB Combination pliers
D Kombinationszange
RUS Плоскогубцы универсальные

CZ Univerzální kleště
RO Patent universal
H Kombináliffogó
E Alicates universal



No.	L (mm)	
40010	160	6/120
40011	180	6/60
40012	200	6/60

PL Szczypce tnące boczne
GB Diagonal side cutting pliers
D Seitenschneider
RUS Бокорезы

CZ Řezací kleště boční
RO Patent de tăiat lateral
H Oldal csípőfogó
E Alicates corte lateral



No.	L (mm)	
40017	160	6/120
40018	180	6/120

PL Szczypce wydłużone proste
GB Long nose pliers
D Radiozange
RUS Тонкогубцы

CZ 3URCBAHQ NDEW rovné
RO Patent drept alungit
H Rádiófogó, egyenes
E Alicates de punta



No.	L (mm)	
40013	160	6/120
40014	200	6/60

PL Szczypce wydłużone wygięte
GB Bent nose pliers
D Telefonzange
RUS Тонкогубцы загнутые

CZ 3URCBAHQ NDEW ohnuté
RO Patent curbăt alungit
H Rádió- és telefonfogó, hajlítot
E Alicates curvos



No.	L (mm)	
40015	160	6/120
40016	200	6/60

PL Szczypce uniwersalne
GB Combination pliers
D Kombinationszange
RUS Плоскогубцы универсальные

CZ Univerzální kleště
RO Patent universal
H Kombináliffogó
E Alicates universal



No.	L (mm)	
40041	160	6/60
40042	180	6/60
40043	200	6/60

PL Szczypce tnące boczne
GB Diagonal side cutting pliers
D Seitenschneider
RUS Бокорезы

CZ Řezací kleště boční
RO Patent de tăiat lateral
H Oldal csípőfogó
E Alicates corte lateral



No.	L (mm)	
40047	160	6/120
40048	180	6/60

PL Szczypce wydłużone proste
GB Long nose pliers
D Radiozange
RUS Тонкогубцы

CZ 3URCBAHQ NDEW rovné
RO Patent drept alungit
H Rádiófogó, egyenes
E Alicates de punta



No.	L (mm)	
40044	160	6/120
40045	180	6/60

PL Szczypce wydłużone wygięte
GB Bent nose pliers
D Telefonzange
RUS Тонкогубцы загнутые

CZ 3URCBAHQ NDEW ohnuté
RO Patent curbăt alungit
H Rádió- és telefonfogó, hajlítot
E Alicates curvos



No.	L (mm)	
40050	160	6/120
40051	180	6/60

PL Szcypce okrągłe
GB Round nose pliers
D Rundzange
RUS Круглогубцы

CZ Kruhové kleště
RO Patent rotund
H Kerekcsőrű fogó
E Alicates redondos

160
mm



No.	L (mm)	
40054	160	6/120

PL Szcypce do ściągania izolacji
GB Wire stripping pliers
D Abisolierzange
RUS Клещи для зачистки проводов

CZ Kleště na sundávání izolace
RO Patent pt. decablat
H Szigeteléseltávolító fogó
E Pinzas pelacables

160
mm



No.	L (mm)	
40056	160	6/60

PL Szcypce tnące czolowe
GB End cutting pliers
D Vorschneider
RUS Кусачки торцевые

CZ Řezací kleště čelní
RO Clește de tăiat frontal
H Homlok csípőfogó
E Alicates corte frontal

160
mm



No.	L (mm)	
40055	160	6/60

PL Szcypce nastawne
GB Water pump pliers
D Wasserpumpenzange
RUS Клещи трубные переставные

CZ Hydraulické kleště nastavitelné
RO Clește instalator tip papagal
H Állítható csípőfogó
E Alicates de fontanero

250
mm



No.	L (mm)	
40057	250	6/60

PL Szcypce nastawne
GB Water pump pliers
D Wasserpumpenzange
RUS Клещи трубные переставные

CZ Hydraulické kleště nastavitelné
RO Clește instalator tip papagal
H Állítható csípőfogó
E Alicates de fontanero

250
mm

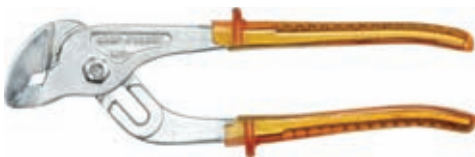

No.	L (mm)	
41500	250	6/60

PL Szcypce tnące czolowe
GB End cutting pliers
D Vorschneider
RUS Кусачки торцевые

CZ Řezací kleště čelní
RO Clește de tăiat frontal
H Homlok csípőfogó
E Alicates corte frontal

180
mm



No.	L (mm)	
41121	180	6/60

PL Obcegi
GB Carpenter's pincers
D Kneifzange
RUS Клещи строительные

CZ Kleště
RO Clește
H Harapőfogó
E Tenazas



No.	L (mm)	
41151	180	6/60
41152	200	6/60

PL Obcegi
GB Carpenter's pincers
D Kneifzange
RUS Клещи строительные

CZ Kleště
RO Clește
H Harapőfogó
E Tenazas



No.	L (mm)	
41180	180	6/120
41200	200	6/60

PL Obcegi tynkarskie
GB Tower pincers
D Beisszange
RUS Клеши штукатурные

CZ Kleště štipací čelní
RO Clește pt. culie
H Rábitzfogó
E Tenazas de enlucido

250 mm



No.	L (mm)	
41381	250	6/60

PL Szczypce do łączenia profili
GB Profile connection pliers
D Zange zum Verbinden der Profile

RUS Щипцы для соединения профилей

CZ Kleště ke spojování profilů
RO Clește pt. îmbinarea profilelor
H Profílegyesítő fogó
E Pinzas para conectar perfiles

280 mm

SECTION THICKNESS GRUBS&C PROFILE 0,5-0,8 mm

65 Mn (PUNCH)



No.	L (mm)	
04300	280	6/36

PL Szczypce uniwersalne
GB Combination pliers
D Kombinationszange
RUS Плоскогубцы высоковольтной серии

CZ Univerzální kleště
RO Patent universal
H Kombínáltfogó
E Alicates universal



No.	L (mm)	V	
40160	160	1000	10/50
40180	180	1000	10/50
40200	200	1000	10/50

PL Szczypce tnące boczne
GB Diagonal side cutting pliers
D Seitenschneider
RUS Бокорезы

CZ Řezací kleště boční
RO Patent de tăiat lateral
H Oldal csípőfogó
E Alicates corte lateral

160 mm



No.	L (mm)	V	
40700	160	1000	5/50

PL Szczypce uniwersalne
GB Combination pliers
D Kombinationszange
RUS Плоскогубцы универсальные

CZ Univerzální kleště
RO Patent universal
H Kombínáltfogó
E Alicates universal

120 mm



No.	L (mm)	
42300	120	12/120

PL Szczypce tnące boczne
GB Diagonal side cutting pliers
D Seitenschneider
RUS Бокорезы

CZ Řezací kleště boční
RO Patent de tăiat lateral
H Oldal csípőfogó
E Alicates corte lateral

110 mm



No.	L (mm)	
42301	110	12/120

PL Szczypce wydłużone proste
GB Long nose pliers
D Radiozange
RUS Тонкогубцы

CZ 3UR303&HQP NDE&W rovné
RO Patent drept alungit
H Rádíofogó, egyenes
E Alicates de punta

125 mm



No.	L (mm)	
42303	125	12/120

PL Szczypce wydłużone proste
GB Long nose pliers
D Radiozange
RUS Тонкогубцы

CZ 3UR303&HQP NDE&W rovné
RO Patent drept alungit
H Rádíofogó, egyenes
E Alicates de punta

150 mm



No.	L (mm)	
42305	150	12/120

PL Szcypce wydłużone wygięte
 GB Bent nose pliers
 D Telefonzange
 RUS Тонкогубцы загнутые
 CZ 3UR3BKAH-Q NDBW ohnuté
 RO Patent curbat alungit
 H Rádió- és telefonfogó hajlított
 E Alicates curvos

125
mm



No.	L (mm)	
42304	125	12/120

PL Szcypce płaskie
 GB Flat nose pliers
 D Elektrikerflachzange
 RUS Утконосы
 CZ 3UR3BKAH-Q NDBW rovné
 RO Clește cu vârf ascuțit
 H Rádiófogó, egyenes
 E Alicates de bocas planas

120
mm



No.	L (mm)	
42306	120	12/120

PL Szcypce okrągłe
 GB Round nose pliers
 D Rundzange
 RUS Круглогубцы
 CZ Kruhové kleště
 RO Patent rotund
 H Kerekcsőrű fogó
 E Alicates redondos

125
mm



No.	L (mm)	
42307	125	12/120

PL Szcypce tnące czołowe
 GB End cutting pliers
 D Vorschneider
 RUS Кусачки торцевые
 CZ Řezací kleště čelní
 RO Clește de tăiat frontal
 H Homlok csípőfogó
 E Alicates corte frontal

110
mm



No.	L (mm)	
42302	110	12/120

PL Zestaw mini szczypiec
 GB Mini pliers set
 D Mini-zangensatz
 RUS Электронные щипцы
 CZ Elektronické kleště
 RO Set mini patenti
 H Elektronikai fogó
 E Alicates electronicas

4
PCS



No.	pcs	
42308	4	25/50

PL Zestaw mini szczypiec
 GB Mini pliers set
 D Mini-zangensatz
 RUS Электронные щипцы
 CZ Elektronické kleště
 RO Set mini patentii si clesti
 H Elektronikai fogó
 E Alicates electronicas

6
PCS



No.	pcs	
42309	6	10/40

PL Szcypce Segera, zewnętrzne proste
 GB Circlip pliers, external straight
 D Seegeringzange aussen. ger.
 RUS Съёмник стопорных колец (разжим)
 CZ Kleště Segera vnější rovné
 RO Clește Seger exterior drept
 H Segerfogó külső, egyenes
 E Alicates Seger exter. de punta



No.	L (mm)	
43010	150	6/120
43011	200	6/120

PL Szcypce Segera, zewnętrzne wygięte
 GB Circlip pliers, external bent
 D Seegeringzange aussen. geb.
 RUS Съёмник стопорных колец (разжим)
 CZ Kleště Segera vnější ohnuté
 RO Clește Seger exterior curbat
 H Segerfogó külső, hajlított
 E Alicates seger exter. curvos



No.	L (mm)	
43020	150	6/120
43021	200	6/120

PL Szczypce Segera, wewnętrzne proste
GB Circlip pliers, internal straight
D Seegeringzange inner. ger.
RUS Съёмник стопорных колец (сжим)

CZ Kleště Segera vnitřní rovné
RO Clește Seger Interior drept
H Segerfogó belső, egyenes
E Alicates seger inter. de punta



No.	L (mm)	Icon
43030	150	6/120
43031	200	6/120

PL Szczypce Segera, wewnętrzne wygięte
GB Circlip pliers, internal bent
D Seegeringzange inner. geb.
RUS Съёмник стопорных колец (сжим)

CZ Kleště Segera vnitřní ohnuté
RO Patent seger Interior curbat
H Segerfogó belső, hajlított
E Alicates seger inter. curvos



No.	L (mm)	Icon
43040	150	6/120
43041	200	6/120

PL Szczypce Segera, zewnętrzne proste
GB Circlip pliers, external straight
D Seegeringzange aussen. ger.
RUS Съёмник стопорных колец (разжим)

CZ Kleště Segera vnější rovné
RO Clește Seger exterior drept
H Segerfogó külső, egyenes
E Alicates Seger exter. de punta



No.	L (mm)	Icon
43050	160	6/60
43055	180	6/60
43060	200	6/60

PL Szczypce Segera, zewnętrzne wygięte
GB Circlip pliers, external bent
D Seegeringzange aussen. geb.
RUS Съёмник стопорных колец (разжим)

CZ Kleště Segera vnější ohnuté
RO Clește Seger exterior curbat
H Segerfogó külső, hajlított
E Alicates seger exter. curvos



No.	L (mm)	Icon
43051	160	6/60
43056	180	6/60
43061	200	6/60

PL Szczypce Segera, wewnętrzne proste
GB Circlip pliers, internal straight
D Seegeringzange inner. ger.
RUS Съёмник стопорных колец (сжим)

CZ Kleště Segera vnitřní rovné
RO Clește Seger interior drept
H Segerfogó belső, egyenes
E Alicates seger inter. de punta



No.	L (mm)	Icon
43052	160	6/60
43057	180	6/60
43062	200	6/60

PL Szczypce Segera, wewnętrzne wygięte
GB Circlip pliers, internal bent
D Seegeringzange inner. geb.
RUS Съёмник стопорных колец (сжим)

CZ Kleště Segera vnitřní ohnuté
RO Patent Seger interior curbat
H Segerfogó belső, hajlított
E Alicates seger inter. curvos



No.	L (mm)	Icon
43053	160	6/60
43058	180	6/60
43063	200	6/60

PL Szczypce Segera
GB Circlip pliers set
D Seegeringzangen satz
RUS Съёмники стопорных колец

CZ Kleště Segera
RO Set clești seger
H Segerfogó
E Alicates seger



No.	L (mm)	pcs	Icon
43140	150	4	5/30

PL Szczypce Segera
GB Circlip pliers set
D Seegeringzangen satz
RUS Съёмник стопорных колец
CZ Kleště Segera
RO Clește pt. inele de siguranță + capete de schimb
H Segerfogó
E Alicates seger



No.	L (mm)	pcs	Icon
43500	150	4	6/60

PL Szczypcy Segera
GB Circlip pliers set
D Seegeringzangen satz
RUS Съёмник стопорных колец

CZ Kleště Segera
RO Cleste pt. Inele de siguranta + capete de schimb
H Segerfogó
E Alicates seger

5
PCS

150
mm



No.	L (mm)	pcs	Icon
43510	150	5	6/60

PL Szczypcy Morse'a
GB Lock grip pliers
D Gripzange
RUS Зажим ручной

CZ Kleště Morse'a
RO Clește Morse
H Morse fogó
E Alicates Morse

250
mm



No.	L (mm)	Icon
44100	250	6/60

PL Szczypcy Morse'a
GB Lock grip pliers
D Gripzange
RUS Зажим ручной

CZ Kleště Morse'a
RO Clește Morse
H Morse fogó
E Alicates Morse

250
mm



No.	L (mm)	Icon
44102	250	6/36

PL Szczypcy spawalnicze
GB Lock grip pliers
D Schweißerzange
RUS Ключ - зажим

CZ Svářečské kleště
RO Cleste autoblocant pt. sudura
H Hegesztő fogó
E Alicates de soldar

275
mm



No.	L (mm)	type	Icon
44300	275	C	6/36

PL Szczypcy zaciskowe klamrowe typu „C”
GB Welding locking pliers „C” type
D Klemm- und Klammerzange vom Typ „C”
RUS Ключи давящие типа „С”
CZ Kleště samosvorné upínací typu „C”
RO Clește de strângere cu clemă tip „C”
H „C” fogó
E Pinzas de tornillo (de apriete) de grapa tipo „C”

280
mm

0-70
mm

TYPE
C



VOREL

No.	L (mm)	type	Icon
44301	280	C	6/30

PL Szczypcy spawalnicze
GB Lock grip pliers
D Schweißerzange
RUS Ключ - зажим

CZ Svářečské kleště
RO Cleste autoblocant pt. sudura
H Hegesztő fogó
E Alicates de soldar

225
mm



No.	L (mm)	type	Icon
44400	225	W	6/36

PL Szczypcy spawalnicze
GB Lock grip pliers
D Schweißerzange
RUS Ключ - зажим

CZ Svářečské kleště
RO Cleste autoblocant pt. sudura
H Hegesztő fogó
E Alicates de soldar

250
mm



No.	L (mm)	type	Icon
44500	250	SM	6/36

PL Szczypcy hydrauliczne nastawne
GB Water pump pliers
D Wasserpumpenzange
RUS Щипцы сантехнические

CZ Keleště s ilko
RO Cleste papagal
H Vízpumpafogó
E Alicates de fontanero ajustables

250
mm



VOREL

No.	L (mm)	Icon
41510	250	10/50

PL Klucz do rur
 GB Pipe wrench
 D Rohrschlüssel
 RUS Ключ трубный

CZ Klíč součástí na trubky
 RO Cheie pt. țevi
 H Csőkulcs
 E Llave de fontanero



No.	L (mm)	☐
55250	250	6/48
55300	300	6/36
55350	350	6/24
55450	450	4/16

PL Klucz do rur
 GB Pipe wrench
 D Rohrschlüssel
 RUS Ключ трубный

CZ Klíč součástí na trubky
 RO Cheie pt. țevi
 H Csőkulcs
 E Llave de fontanero



No.	L (mm)	☐
55620	200	6/60
55625	250	6/36
55630	300	4/24
55635	350	4/16
55645	450	3/12
55660	600	3/6
55690	900	4

PL Klucz nastawny do rur
 GB Adjustable pipe wrench
 D Rohrschlüssel
 RUS Ключ трубный переставной

CZ Nastavitelný klíč na trubky
 RO Cheie reglabilă pt. țevi
 H Állítható csőkulcs
 E Llave de vaso para tubería

45°



No.	size / rozmiar	☐
55100	1.0" (25 mm)	12/36
55150	1.5" (38 mm)	10/20
55200	2.0" (50 mm)	6/12

PL Klucz nastawny do rur
 GB Adjustable pipe wrench
 D Rohrschlüssel
 RUS Ключ трубный переставной

CZ Nastavitelný klíč na trubky
 RO Cheie reglabilă pt. țevi
 H Állítható csőkulcs
 E Llave de vaso para tubería

45°



No.	size / rozmiar	☐
55210	1.0" (25 mm)	24
55211	1.5" (38 mm)	16
55212	2.0" (50 mm)	8

PL Klucz nastawny do rur
 GB Adjustable pipe wrench
 D Rohrschlüssel
 RUS Ключ трубный переставной

CZ Nastavitelný klíč na trubky
 RO Cheie reglabilă pt. țevi
 H Állítható csőkulcs
 E Llave de vaso para tubería

90°



No.	size / rozmiar	☐
55215	1.0" (25 mm)	24
55216	1.5" (38 mm)	16
55217	2.0" (50 mm)	8

PL Klucz nastawny do rur
 GB Adjustable pipe wrench
 D Rohrschlüssel
 RUS Ключ трубный переставной

CZ Nastavitelný klíč na trubky
 RO Cheie reglabilă pt. țevi
 H Állítható csőkulcs
 E Llave de vaso para tubería

S



No.	size / rozmiar	☐
55220	1.0" (25 mm)	24
55221	1.5" (38 mm)	16
55222	2.0" (50 mm)	8

PL Klucz nastawny francuski
 GB Adjustable wrench
 D Stahlschraubenschlüssel /franzose/
 RUS Ключ разводной

CZ Nastavitelný klíč francuz
 RO Cheie reglabilă franceză
 H Állítható franciakuics
 E Llave ajustable inglesa



No.	KNF	☐
54499	45	10
54500	55	5
54510	65	5



5

5

Electrician tools **Narzędzia dla elektryków**

Crimping pliers
Szczypce do zaciskania
konektorów

48



Ratchet crimping pliers
Szczypce do zaciskania
konektorów z grzechotką

48



Wire strippers
Ściągacze izolacji

48-49



Electrical cutters
Obcinaki elektryczne

49



Voltage testers
Próbniki napięcia

49



Digital universal meters
Cyfrowe mierniki uniwersalne

49-50



- PL Szczypce do zaciskania konektorów
 GB Ratchet crimping pliers
 D Kabelschuhzange
 RUS Инструмент для обжима и зачистки проводов
 CZ Kleště pro svěrání zaciskania konektorů
 RO Clește sertizat conectori
 H Krimpelő fogó
 E Pinzas de apretar de conectores



220 mm



No.	L (mm)	mm ²	AWG	
45500	220	0.5-2.5	20-14	12/36

- PL Szczypce do zaciskania konektorów
 GB Ratchet crimping pliers
 D Kabelschuhzange
 RUS Инструмент для обжима и зачистки проводов
 CZ Kleště pro svěrání zaciskania konektorů
 RO Clește sertizat conectori
 H Krimpelő fogó
 E Pinzas de apretar de conectores

12 x RJ45

12 x RJ11

2.5m



No.	
45503	10/40

- PL Szczypce do zaciskania konektorów
 GB Ratchet crimping pliers
 D Kabelschuhzange
 RUS Инструмент для обжима и зачистки проводов
- CZ Kleště pro svěrání zaciskania konektorů
 RO Clește sertizat conectori
 H Krimpelő fogó
 E Pinzas de apretar de conectores

210 mm



No.	L (mm)	
45000	210	12/120

- PL Zaciskacz z konektorami w kasce
 GB Solderless terminal kit
 D Kabelschuhzange u. kabelschuhe
 RUS Электрорассадка с вилками и кольцами под обжим
- CZ Svěrka z konektorama v kazetě
 RO Set cleste mufare plus conectori
 H Présszerszám csatlakozókkal egy dobozban
 E Apretador con conectores en caja

100 PCS



No.	pcs	
45050	100	25/50

- PL Automacyjny ściągacz izolacji
 GB Wire stripper / crimper
 D Automatische abisolierzange
 RUS Клещи-автомат для снятия изоляции
- CZ Automatický stahovač izolace
 RO Decablator automat
 H Automatikus szigeteléslehúzó
 E Pelacables automatico

165 mm



No.	L (mm)	
45100	165	20/100

- PL Automacyjny ściągacz izolacji
 GB Wire stripper / crimper
 D Automatische abisolierzange
 RUS Клещи-автомат для снятия изоляции
- CZ Automatický stahovač izolace
 RO Decablator automat
 H Automatikus szigeteléslehúzó
 E Pelacables automatico

170 mm



No.	L (mm)	mm	
45103	170	0.2-5.5	12/48

- PL Automacyjny ściągacz izolacji
 GB Wire stripper / crimper
 D Automatische abisolierzange
 RUS Клещи-автомат для снятия изоляции
- CZ Automatický stahovač izolace
 RO Decablator automat
 H Automatikus szigeteléslehúzó
 E Pelacables automatico

180 mm

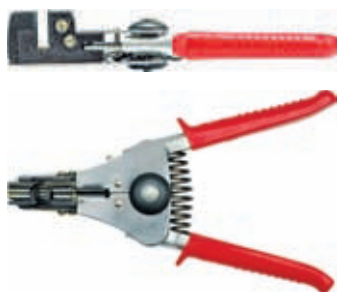

No.	L (mm)	
45150	180	6/60

- PL Automacyjny ściągacz izolacji
 GB Wire stripper / crimper
 D Automatische abisolierzange
 RUS Клещи-автомат для снятия изоляции
- CZ Automatický stahovač izolace
 RO Decablator automat
 H Automatikus szigeteléslehúzó
 E Pelacables automatico

160 mm

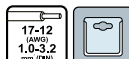

No.	L (mm)	mm	
45151	160	1.0-3.2	10/50

PL Automacyjny ściągacz z obcinakiem
 GB Automatic wire stripper with cutter
 D Automatische abisolierzange +
 Schneider
 RUS Клещи-автомат для снятия изоляции

CZ Automatický stahovač izolace
 RO Decablator automat
 H Automatikus szigeteléslehúzó
 E Pelacables automatico

170 mm

20-13 (AWG) 0,5-4,0 mm (DIN)

28-14 (AWG) 0,08-2,0 mm (DIN)



No.	L (mm)	
45201	170	10/50

PL Ściągacz izolacji
 GB Wire stripper
 D Abisolierzange
 RUS Съёмник изоляции

CZ Odizolovač klejte
 RO Decablator
 H Blankolo fogo
 E Extractor de aislado

185 mm

22-10 (AWG) 0,64-2,6 mm (DIN)

M4-M5

HRC 50-53



No.	L (mm)	
45010	185	12/120

PL Ściągacz izolacji
 GB Wire stripper
 D Abisolierzange
 RUS Съёмник изоляции

CZ Odizolovač klejte
 RO Decablator
 H Blankolo fogo
 E Extractor de aislado

215 mm

22-10 (AWG) 0,64-2,6 mm (DIN)

HRC 50-53

26-10 (AWG) 0,4-2,6 mm (DIN)

M3-M5

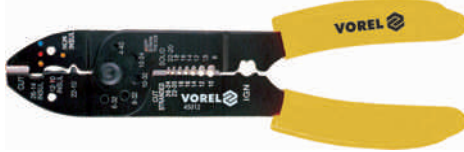

No.	L (mm)	
45012	215	12/72

PL Obcinak elektryczny
 GB Electrical cutter
 D Seitenschneider
 RUS Электрический резак со съёмником

CZ Elektrické upichovačky ze stahovačím
 RO Clește tăietor - electrician
 H Kábelvágó
 E Cortacables eléctricos

135 mm

HRC 55-57



No.	L (mm)	
45020	135	12/120

PL Próbnik napięcia
 GB Voltage tester
 D Spannungsprüfer
 RUS Отвёртка индикаторная

CZ Zkoušeč napětí
 RO Creion de tensiune
 H Fáziskereső
 E Comprobador de corriente

140 mm



No.	L (mm)	
65233	140	12/1200

PL Próbnik napięcia
 GB Voltage tester
 D Spannungsprüfer
 RUS Отвёртка индикаторная

CZ Zkoušeč napětí
 RO Creion de tensiune
 H Fáziskereső
 E Comprobador de corriente

190 mm



No.	L (mm)	
65235	190	12/600

PL Cyfrowy miernik uniwersalny
 GB Digital universal multimeter
 D Universal digital multimeter
 RUS Универсальный цифровой измеритель
 CZ Digitální multimetr - univerzální
 RO Multimetru digital universal
 H Digitális multiméter
 E Manómetor digital universal



U A.C. 0-500V

U D.C. 0-500V

I D.C. 0-5A

R 0-2MΩ

h_{FE} PNP NPN



No.		
81780		12/72

PL Cyfrowy miernik uniwersalny
 GB Digital universal multimeter
 D Universal digital multimeter
 RUS Универсальный цифровой измеритель
 CZ Digitální multimetr - univerzální
 RO Multimetru digital universal
 H Digitális multiméter
 E Manómetor digital universal



U A.C. 0-750V

U D.C. 0-1000V

I A.C. 0-20A

I D.C. 0-20A

R 0-200 MΩ

C 0-20μF

h_{FE} PNP NPN

AUTO POWER OFF



No.	digit height / wysokość cyfr (mm)	
81783	25	20

Memo

6

6

Hammers, chisels, punches & axes **Młotki, dłuta, przecinaki i siekiery**

Machinist hammers
Młotki ślusarskie

54-55

Machinist hammers with wooden handle Młotki ślusarskie z rączką drewnianą.....	54
Machinist hammers with fibreglass handle Młotki ślusarskie z rączką z włókna szklanego.....	54
Machinist hammers „Juco” Młotki ślusarskie „Juco”.....	54
Brick hammers „Juco” Młotki murarskie „Juco”.....	55
Welder’s hammers „Juco” Młotki spawalnicze „Juco”.....	55

Stoning hammers
Młotki kamieniarskie

55

Stoning hammers „Juco” Młotki kamieniarskie „Juco”.....	55
---	----

Hammers with tubular steel handle
Młotki z trzonkiem rurowym

55-56

Claw hammers Młotki szewskie.....	55
Roofing hammers Młotki ciesielskie.....	55
Mason’s hammers Młotki murarskie.....	56

Hammers with fibreglass handle
Młotki z rączką z włókna szklanego

56

Claw hammers Młotki szewskie.....	56
Roofing hammers Młotki ciesielskie.....	56

Rubber mallets
Młotki gumowe

56-57

Rubber mallets with wooden handle Młotki gumowe z rączką drewnianą.....	56
Rubber mallets with tubular steel handle Młotki gumowe z rączką stalową.....	56
Rubber mallets with fibreglass handle Młotki gumowe z rączką z włókna szklanego.....	56
Soft faced mallets Młotki blacharskie gumowo-plastykowe.....	56
Auto body fender sets Komplety młotków blacharskich.....	57

Chisels, cold chisels, punches & wrecking bars
Dłuta, przecinaki, przebijaki i łomy

57-59

Wood chisels with wooden handle Dłuta stolarskie z rączką drewnianą.....	57
Wood chisels with plastic handle Dłuta stolarskie z rączką z tworzywa.....	57

Curving chisels Dłuta snycerskie.....	57
Cold chisels Przecinaki.....	57
Cold chisels „Juco” Przecinaki „Juco”.....	58
Punches Przebijaki.....	58
Wrecking bars Łomy.....	58
Wrecking bars „Juco” Łomy „Juco”.....	59

Axes
Siekiery

59-60

Axes with wooden handle Siekiery z trzonkiem drewnianym.....	59
Axes with fibreglass handle Siekiery z trzonkiem z włókna szklanego.....	59
Axes „Juco” Siekiery „Juco”.....	59

Picaxes
Kilofy

60-61

Pickaxes Kilofy.....	60
Wood splitters „Juco” Kliny do rozłupywania drewna „Juco”.....	61

PL Młotek ślusarski
GB Machinist hammer
D Schlosserhammer
RUS Молоток слесарный

CZ Zámečnické kladívko
RO Ciocan de lăcătușerie
H Vaskalapács
E Martillo



No.	g	
30010	100	12/120
30020	200	12/72
30030	300	12/60
30040	400	6/48
30050	500	6/36
30060	600	6/36
30080	800	6/24
30100	1000	6/24
30150	1500	6/12
30200	2000	6/12

PL Młotek ślusarski
GB Machinist hammer
D Schlosserhammer
RUS Молоток слесарный

CZ Zámečnické kladívko
RO Ciocan de lăcătușerie
H Vaskalapács
E Martillo



No.	g	
30410	100	12/120
30420	200	6/60
30430	300	6/60
30440	400	6/48
30450	500	6/36
30460	600	6/36
30480	800	6/24
30500	1000	6/24
30510	1500	6/12
30520	2000	6/12

PL Młot kowalski
GB Machinist hammer
D Schlosserhammer
RUS Молоток слесарный

CZ Zámečnické kladívko
RO Ciocan de lăcătușerie
H Vaskalapács
E Martillo



No.	kg	
30531	3	1
30532	4	1
30533	5	1
30534	6	1
30535	8	1
30536	10	1

PL Młotek ślusarski, rączka z włókna szklanego
GB Machinist hammer with fibreglass + PVC handle
D Schlosserhammer Fiberglassstiel
RUS Молоток со стеклопластиковой ручкой
CZ Zámečnické kladívko
RO Ciocan de lăcătușerie
H Vaskalapács
E Martillo



No.	g	
30310	100	6/120
30320	200	6/36
30330	300	6/48
30340	400	6/36
30350	500	6/36
30360	600	6/36
30380	800	6/24
30390	1000	6/24
30395	1500	6/12
30400	2000	6/12

PL Młotek ślusarski
GB Machinist hammer
D Schlosserhammer
RUS Молоток слесарный

CZ Zámečnické kladívko
RO Ciocan de lăcătușerie
H Vaskalapács
E Martillo



No.	kg	
31010	0.1	10
31030	0.3	10
31050	0.5	10
31070	0.7	10
31100	1.0	10
31150	1.5	6
31200	2.0	6
31300	3.0	1
31400	4.0	1
31500	5.0	1
31600	6.0	1
31800	8.0	1
32000	10.0	1

Hammers, chisels, punches & axes / Mlotki, dłuta, przecinaki i siekiery

PL Młotek ślusarski
GB Machinist hammer
D Schlosserhammer
RUS Молоток слесарный

CZ Zámečnické kladívko
RO Ciocan de lăcătușerie
H Vaskalapács
E Martillo



JUCO

No.	g	
29992	300	5
29993	500	5
29994	700	5
29995	1000	5
29996	1500	5
29997	2000	5

PL Młotek murarski
GB Brick hammer
D Maurerhammer
RUS Молоток каменщика

CZ Zednické kladívko
RO Ciocan de zidărie
H Kőműves kalapács
E Martillo albañil



JUCO

No.	g	
32720	700	5

PL Młotek spawalniczy
GB Welder's hammer
D Schweißerhammer
RUS Молоток сварочный

CZ Svářečské kladívko
RO Ciocan de sudură
H Hegesztő kalapács
E Martillo para soldar



JUCO

No.	g	
32110	350	5

PL Młotek kamieniarski
GB Safety stoning hammer
D Fäustel
RUS Молоток каменщика

CZ Palička kovová
RO Ciocan pt. zidarie
H Kőtoró kalapács
E Martillo



JUCO

No.	kg	
32201	1.5	6
32202	2.0	6
32203	3.0	1
32204	4.0	1
32205	5.0	1
32206	6.0	1
32207	8.0	1
32208	10.0	1

PL Młotek szewski, rączka ze stali
GB Claw hammer with tubular steel handle
D Klauenhammer
RUS Молоток-гвоздодер

CZ Ševcovské kladívko
RO Ciocan de cizmărie
H Cípész kalapács
E Martillo sacador mango de acero



VOREL

No.	g	
32625	600	6/24

PL Młotek ciesielski, rączka ze stali
GB Roofing hammer with tubular steel handle
D Lattenhammer
RUS Молоток жестящика

CZ Tesařské kladívko
RO Ciocan de dulgherie
H Ácskalapács
E Martillo sacador mango de acero



VOREL

No.	g	
32685	600	6/24

PL Młotek murarski berliński, rączka ze stali
 GB Mason's hammer type „B” with tubular steel handle
 D Berliner mauerhammer
 RUS Молоток каменщика широкий

CZ Zednické kladívko berlínské
 RO Ciocan de zidărie tip Berlin
 H Kőműves kalapács, berlini típus
 E Martillo berlin mango de acero



No.	g	
32705	600	6/24

PL Młotek murarski reński, rączka ze stali
 GB Mason's hammer type „R” with tubular steel handle
 D Maurerhammer rheinische form
 RUS Молоток каменщика узкий

CZ Zednické kladívko renské
 RO Ciocan de zidărie
 H Kőműves kalapács, rajnai típus
 E Martillo rin mango de acero



No.	g	
32715	600	6/24

PL Młotek szewski, rączka z włókna szklanego
 GB Claw hammer with fibreglass + PVC handle
 D Klauenhammer fibreglasstiel
 RUS Молоток гвоздодер со стеклопластиковой ручкой
 CZ Kladivo ševcovské, ručka ze skleněných vláken
 RO Cican pt. cismari, cu mâner din fibră de sticlă
 H Cipész kalapács
 E Martillo sacador con mango de fibra de vidrio



No.	g	
32627	600	6/24

PL Młotek ciesielski, rączka z włókna szklanego
 GB Roofing hammer with fibreglass + PVC handle
 D Lattenhammer fibreglasstiel
 RUS Молоток жестящика со стеклопластиковой ручкой
 CZ Kladivo tesařské, ručka ze skleněných vláken
 RO Ciocan de dulgherie
 H Ácskalapács
 E Martillo de carpintero con mango de fibra de vidrio



No.	g	
32687	600	6/24

PL Młotek gumowy
 GB Rubber mallet
 D Gummihammer
 RUS Киянка резиновая

CZ 3 Účarýp NDGYNR
 RO Ciocan de cauciuc
 H Gumikalapács
 E Mazo de goma



No.	mm	
33550	45	36/72
33650	55	12/60
33900	70	12/24

PL Młotek gumowy z rączką stalową
 GB Rubber mallet with steel handle
 D Gummihammer stahlstiel
 RUS Киянка резиновая

CZ 3 Účarýp NDGYNR
 RO Ciocan de cauciuc
 H Gumikalapács
 E Mazo de goma



No.	mm	
33557	50	6/60
33657	56	12/48
33907	66	6/24
33927	76	6/24

PL Młotek gumowy, rączka z włókna szklanego
 GB Rubber mallet with fibreglass + PVC handle
 D Gummihammer fibreglasstiel
 RUS Киянка резиновая с фиброглассовой ручкой

CZ 3 Účarýp NDGYNR
 RO Ciocan de cauciuc
 H Gumikalapács
 E Mazo de goma



No.	mm	
33535	45	6/60
33555	50	6/48
33655	56	6/30
33905	66	6/24
33925	76	6/24

PL Młotek blacharski, guma - plastik
 GB Soft faced mallet
 D Ausbeulhammer
 RUS Молоток рихтовочный

CZ Klempířské kladívko
 RO Ciocan pt. tabla
 H Bádógos kalapács
 E Mazo goma-plastico

35 mm



No.	mm	
33950	35	30/60

Hammers, chisels, punches & axes / Mlotki, dłuta, przecinaki i siekiery

PL Komplet młotków blacharskich
GB Auto body fender set
D Blechslosserhammersatz
RUS Молотки рихтовочные в наборе

CZ Souprava klempířských kladívek
RO Set ciocane tinichigerie
H Bádogos kalapács készlet
E Juego de mazos de hojalatero

7
PCS



No.	pcs	
34000	7	10

PL Zestaw dłut stolarskich
GB Wood chisel set
D Stechbeitelsatz
RUS Набор стамесок

CZ Zámečnické dláta
RO Dalte de tâmplărie
H Asztalos véső
E Cinceles de carpintero

4
PCS



No.	pcs	
25500	4	10/40

PL Dłuto
GB Chisel
D Stechbeitel
RUS Стамеска ударная

CZ Řezbářské dláto
RO Daltă de tâmplărie
H Asztalos véső
E Cincel con mango transparente



No.	mm	
25510	6	5/100
25511	8	5/100
25512	10	5/100
25513	12	5/100
25514	14	5/100
25515	15	5/100
25516	18	5/100
25517	20	5/100
25518	22	5/100
25519	25	5/100
25520	32	5/100
25521	38	5/100

PL Zestaw dłut do drewna
GB Wood chisel set
D Stechbeitelsatz
RUS Набор стамесок
CZ Zámečnické dláta
RO Set dalti
H Asztalos véső
E Juego de cinceles

4 PCS 6 mm 12 mm
18 mm 24 mm



No.	mm	pcs	
25530	6; 12; 18; 24	4	10/40

PL Zestaw dłut snycerskich
GB Curving chisel set
D Holzschnittwerkzeugsatz
RUS Набор стамесок фигурных

CZ Řezbářské dláta
RO Dalte curbate cu mâner din lemn
H Finom véső
E Cinceles mango de madera

6
PCS



No.	pcs	
25700	6	15/60

PL Przecinak płaski z osłoną
GB Octagonal cold chisel with protection
D Flachmeißel mit handschutz
RUS Зубило с протектором

CZ Plochný sekáč /z krytem/
RO Dalta zidarie cu protectie
H Hldegvágó, lapos /védőfejjel/
E Cincel plano /con protector/



No.	L (mm)	
35250	250	12/72
35300	300	12/48

PL Przecinak z osłoną
GB Cold chisel with protection
D Flachmeißel mit handschutz
RUS Зубило с протектором

CZ Sekáč /z krytem/
RO Dalta cu protectie
H Hldegvágó, /védőfejjel/
E Cincel /con protector/



No.	mm	
35351	25x300	12/36
35352	25x350	10/30
35353	25x400	12/24
35355	25x500	5/20

PL Przecinak ślusarski
GB Forged cold chisel
D Flachmeißel
RUS Зубило слесарное

CZ Zámečnický sekáč
RO Delta forjată pt. metal
H Lakatos hidegvágó
E Cincel de cerrajería



No.	L (mm)	
35372	200	10
35373	250	10
35374	300	10
35376	400	10

PL Przebijak murarski z osłoną
GB Octagonal point chisel with protection
D Spitzmeißel mit handschutz
RUS Керн с протектором

CZ Sekáč zednický s ochranným
RO Dom cu protecție pt. construcții
H Falvesső kézvédővel
E Cincel de cerrajería con protector



No.	L (mm)	
35430	300	12/48

PL Przecinak murarski z osłoną
GB Forged cold chisel with protection
D Meißel mit handschutz
RUS Зубило с протектором

CZ Zámečnický sekáč /z krytem/
RO Delta forjată cu protecție
H Fém hidegvágó, kézvédővel
E Cincel de cerrajería mm con protector



No.	L (mm)	
35359	250	5
35360	300	5
35362	350	5
35364	400	5
35366	450	5
35368	500	5

PL Łom
GB Wrecking bar
D Nagelisen
RUS Лом

CZ Páčidlo
RO Ranga
H Szögkihúzó
E Palanqueta



No.	mm	
34243	500x18	10
34245	700x18	10
34247	1000x18	10

PL Łom płaski hartowany
GB Flat wrecking bar
D Nagelisen gehärtete spitze
RUS Лом плоский закаленный

CZ Páčidlo ploché kalené
RO Ranga plată
H Lapos feszítővas
E Palanqueta



No.	mm	
34251	450x6x35	6/24

PL Łom kwadratowy, hartowane końcówki
GB Square type wrecking bar
D Nagelisen gehärtete spitze
RUS Лом квадратный с закаленными концами

CZ Páčidlo hranaté, kalené konce
RO Ranga patrata
H Négyyszög keresztmetszetű feszítővas, edzett véggel
E Palanqueta



No.	mm	
34254	400x22x12	12/24
34256	600x30x16	6/12

PL Łom
GB Wrecking bar
D Nagelisen
RUS Лом-гвоздодёр

CZ Páčidlo
RO Ranga pt. scos cuie
H Szögkihúzó
E Palanqueta



No.	L (mm)	
34300	300	60

PL Łom
GB Wrecking bar
D Nagelisen
RUS Лом-гвоздодёр

CZ Páčidlo
RO Ranga pt. scos cuie
H Szögkihúzó
E Palanqueta



No.	L (mm)	
34600	600	24
34750	750	6/12
34900	900	24

Hammers, chisels, punches & axes / Mlotki, dłuta, przecinaki i siekiery

PL Łom sześciokątny
GB Wrecking bar
D Brechstange
RUS Лом-шестигранный шестигранный

CZ Šestiúhľé páčidlo
RO Ranga pt. scos cuie Profi
H Halszögű feszítővas
E Palanqueta



JUJO



No.	L (mm)	
34204	400	5
34205	500	5
34206	600	5
34207	700	5
34208	800	5
34210	1000	5
34212	1250	5

PL Łom budowlany
GB Wrecking bar
D Baubrechstange
RUS Лом круглый

CZ Slavební páčidlo
RO Ranga Profi
H Szögkihuzó
E Palanqueta de obra



JUJO



No.	L (mm)	
34220	1000	1
34222	1200	1
34225	1500	1

PL Siekiera ze stali kutej
GB Drop forged hatchet
D Handbell
RUS Топор стальной кованный

CZ Sekera ocelová kovaná
RO Toporişca lama forjată
H Kovácsolt acél fejsze
E Hacha de metalo forjado



FLO

No.	kg	
33080	0.8	12/24

PL Siekiera
GB Axe
D Handbell
RUS Топор

CZ Sekyřka
RO Toporişca
H Szeķerce
E Hacha



FLO

No.	kg	
32930	1.0	10

PL Siekiera
GB Axe
D Handbell
RUS Топор

CZ Sekyřka
RO Toporişca
H Szeķerce
E Hacha



FLO

No.	g	
33067	600	24
33087	800	20
33107	1000	12
33127	1250	12
33147	1400	12
33177	1600	12

PL Siekiera, ręczka z włókna szklanego
GB Axe with fibreglass + PVC handle
D Handbell fibreglasstiel
RUS Топор строительный с фиберглассовой ручкой

CZ Sekyřka
RO Toporişca cu coada din fibra de sticlă
H Szeķerce
E Hacha con mango de fibra de vidrio



VOREL

No.	g	
33065	600	20
33085	800	20
33105	1000	12
33125	1250	6

PL Siekiera
GB Axe
D Handbell
RUS Топор

CZ Sekyřka
RO Toporişca
H Szeķerce
E Hacha

JUJO

No.	kg	
33024	0.4	5
33026	0.6	5
33028	0.8	5
33030	1.0	5
33032	1.25	5
33035	1.50	5
33038	1.80	5
33039	2.0	5
33040	2.50	5



PL Siekiera CZ Sekyrka
 GB Axe RO Toporîsca
 D Handbeil H Szekeerce
 RUS Топор E Hacha



No.	kg	
33000	0.4	5
33001	0.6	5
33002	0.8	5
33003	1.0	5
33004	1.25	5
33005	1.50	5
33006	1.80	5
33007	2.0	5
33008	2.50	5



6

PL Siekiera z klinem CZ Sekyrka
 GB Axe RO Toporîsca
 D Handbeil H Szekeerce
 RUS Топор E Hacha



No.	kg	
32924	2	5

PL Siekiero-młot CZ Sekera-kladivo
 GB Hammer-axe for wood splitting RO Secure-ciocan
 D Spaltaxt H Szekeerce-kalapács
 RUS Топор-колун E Hacha martillo para partir madera



No.	kg	
32925	2.5	1
32926	4.0	1

PL Siekiera kanadyjska CZ Sekera kanadská
 GB Canadian axe RO Topor canadian
 D Handbeil „Kanadische Form“ H Hosszú nyelű, hasító fejsze
 RUS Топор тип канадский E Hacha canada

1.8 kg



No.	kg	
33022	1.8	5

PL Kilof bez trzonka CZ Krumpáč osazený
 GB Pick axe RO Târncop
 D Spitzhacke ohne Stiel H Ékelt csákány
 RUS Кирка двусторонняя E Piqueta

2.5 kg



No.	kg	
32901	2.5	8

PL Trzonek do kilofa CZ Násada na krumpáč
 GB Wooden handle for pick axe RO Coada târnacop
 D Stiel für Spitzhacke H Csákánynyél
 RUS Черенок для кирки E Palo para pico

90 cm



No.	L (mm)	for / dla	
32902	90	32901	10

PL Kilof oprawiony CZ Krumpáč osazený
 GB Pick axe RO Târncop cu coadă
 D Spitzhacke H Ékelt csákány
 RUS Кирка двусторонняя E Piqueta

1.5 kg



No.	kg	
32904	1.5	1

7

Clamps & vices Ściski i imadła

7

Clamps
Ściski

64-65

F-clamps & sets

Ściski stolarskie i zestawy..... 64

Quick release clamps

Ściski szybkozaciskowe..... 64

Spring clamps

Ściski sprężynowe..... 64

Corner clamps

Ściski kątowe..... 64

C-clamps

Ściski typu „C”..... 65

Ratchet floor clamps

Pasy ściągające do paneli podłogowych..... 65

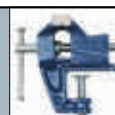
Vices
Imadła

65-66

Baby vices

Imadła stołowe..... 65

Bench vices

Imadła ślusarskie..... 66

Hinged pipe vices

Imadła zaciskowe do rur..... 66

PL Ścisk stolarski
GB F-clamp
D Schraubzwinge
RUS Струбцина

CZ Truhlářské upínadlo
RO Presa lemn
H Asztafos szorító
E Tornillo de apriete



No.	mm	
37100	50x100	12/60
37101	50x150	12/60
37102	50x200	12/60
37103	50x250	12/60
37104	50x300	12/60
37106	80x200	10/30
37107	80x250	10/30
37108	80x300	10/20
37109	80x500	10/20
37110	120x300	10/20
37111	120x500	10
37112	120x800	10
37113	120x1000	6
37114	120x1200	6
37115	120x1500	6

PL Ścisk stolarski
GB F-clamp
D Schraubzwinge
RUS Струбцина

CZ Truhlářské upínadlo
RO Presa lemn
H Asztafos szorító
E Tornillo de apriete



No.	mm	
37150	50x150	12/60
37200	50x200	12/60
37250	50x250	12/60
37300	50x300	12/60
37380	80x300	15/30
37400	80x500	15/30
37430	120x300	10/20
37500	120x500	10/20
37800	120x800	10
37900	120x1000	10

PL Ścisk szybkozaciśkowy
GB Quick release clamp
D Schnellklemme
RUS Быстрозажимная струбцина

CZ Svěrka rychloupínací
RO Clemă cu prindere rapidă
H Gyors asztafos szorító
E Aprelador rápido



No.	mm	max. expand range / max. zasięg rozpięcia (mm)	max. clamping range / max. zasięg ściskania (mm)	max. jaws depth / max. głębokość szczęk (mm)	
38401	150	141-312	0-152	63	12/36
38402	200	141-355	0-203	63	6/36
38403	250	141-405	0-254	63	6/30
38404	300	141-464	0-304	63	6/30
38406	400	141-555	0-406	63	6/24
38407	450	141-617	0-457	63	6/24
38408	600	141-769	0-609	63	6/18
38409	750	141-922	0-762	63	6/12

PL Ścisk stolarski
GB F-clamp
D Schraubzwinge
RUS Струбцина

CZ Truhlářské upínadlo
RO Presa lemn tip „F”
H Asztafos szorító
E Tornillo de apriete



No.	mm	pcs. packing	
38150	50x150	2	10/30
38200	50x200	2	10/30

PL Ścisk sprężynowy
GB Spring clamp
D Federklemme
RUS Струбцина пружинная

CZ 3 Úhlový XSIDCIBR
RO Cleste presa pt. lemn
H Rugós szorító
E Pinza



No.	mm	
38500	100	24/240
38515	150	12/120
38525	200	10/100

PL Ścisk stolarski kątowy
GB Corner clamp
D Gehrungszwinge
RUS Струбцина угловая

CZ Truhlářské upínadlo úhlové
RO Cleste presa colt
H Asztafos szorító, sarok
E Tornillo de angulo



No.	mm	
38750	75	10/100

PL Ścisik stolarski kątowy
GB Corner clamp
D Gehrungszwinge
RUS Струбцина угловая

CZ Truhlářské upínadlo úhlové
RO Cleste presa colt
H Asztalos szorító, sarok
E Tornillo de angulo

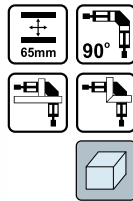

No.	mm	
38751	65	6/12

PL Ścisiki modelarskie
GB C-clamp set
D Mini-schraubwingensatz
RUS Набор струбцин G-типа

CZ Modelářské upínadlo
RO Presa lemă tip „C” set
H Modellező szorítók
E Tornillos tipo „C”



No.	mm	
38830	25; 50; 75	12/48

PL Pas ściągający do paneli podłogowych
GB Ratchet floor clamp
D Spanngurt für Laminatpannele /mit Hacken und Knarre/
RUS Ремень для стяжки напольных панелей
CZ 6 VIKRYDA SI V CD SRADODI SDCHEM
RO Curea elastică strâns plăci parchet
H Padlópanelhez rögzítő pánt
E Cinta tirante para placas de suelo



No.	tape / taśma L (m)	
82355	5	10/20

PL Imadło stolowe
GB Baby vice - fixed base
D Bankschraubstock
RUS Тиски настольные неповоротные

CZ Stolní svěrák
RO Menghină de masă
H Satu, asztal
E Tornillo de apriete



No.	mm	
36000	25	15/60
36004	40	12/48
36005	50	18/36
36006	60	12/24
36008	70	10/20

PL Imadło stolowe obrotowe
GB Baby vice - swivel base
D Bankschraubstock drehbar
RUS Тиски настольные поворотные

CZ Stolní svěrák otáčivý
RO Menghină rotativă de masă
H Satu, asztal, forgó
E Tornillo de apriete giratorio



No.	mm	
36014	40	12/24
36015	50	10/20
36016	60	9/18
36018	75	6/12

PL Imadło stolowe
GB Baby vice - fixed base
D Bankschraubstock
RUS Тиски настольные

CZ Stolní svěrák
RO Menghină de masă
H Satu, asztal
E Tornillo de apriete



No.	mm	
36650	65	10

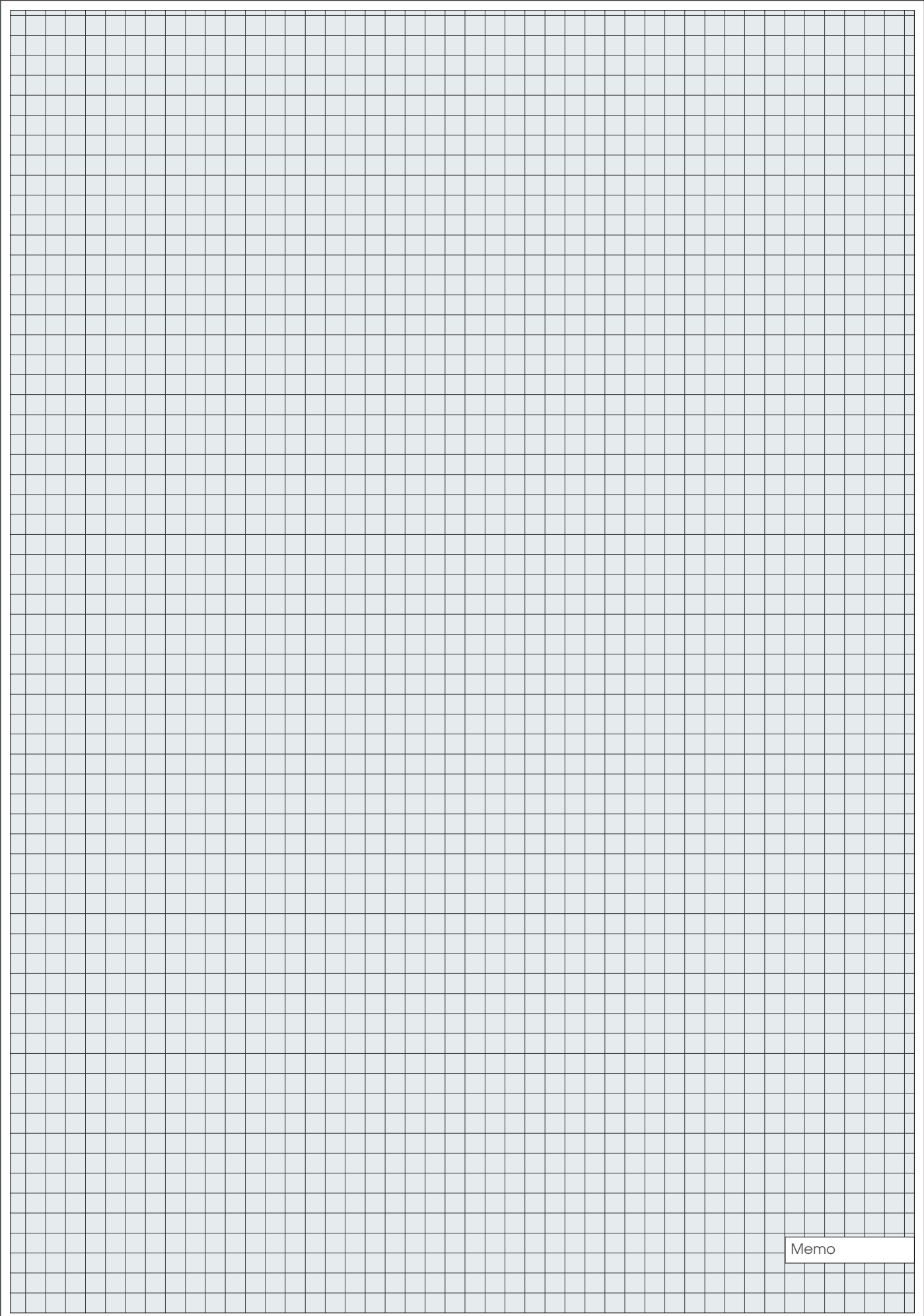

Memo

8

Cutting tools Narzędzia tnące

Drill bits Wiertła



71-77

Twist drill bits HSS & sets Wiertła do metalu HSS i zestawy.....	71
Twist drill bits HSS-G & sets Wiertła do metalu HSS-G i zestawy.....	72
Masonry drill bits & sets Wiertła do betonu i zestawy.....	72
Masonry drill bits with cylindrical shank Wiertła do betonu z uchwytem cylindrycznym.....	72
Wood drill bits Wiertła do drewna.....	73
SDS Masonry drill bits & sets Wiertła do betonu SDS i zestawy.....	74
SDS Chisels Przecinaki i dłuta SDS.....	74
Hollow drill sets Wiertła koronowe do betonu.....	76
Hole saw kits Zestawy otwornic.....	76
Tungsten carbide hole saws Otwornice z węglikiem wolframu.....	77
Tile and glass drill bits Wiertła do glazury i szkła.....	77

Taps & dies Narzędzia do gwintowania



77-79

Hand taps CZ TOOLS Gwintowniki CZ TOOLS.....	77
Circular dies CZ TOOLS Narzynki CZ TOOLS.....	78
Machine taps CZ TOOLS Gwintowniki maszynowe CZ TOOLS.....	78
Tap & die sets CZ TOOLS Zestawy gwintowników i narzynek CZ TOOLS.....	78
Tap wrenches & die holders Pokrętła do gwintowników i narzynek.....	78
Tap & die sets Zestawy gwintowników i narzynek.....	79
Screw extractor sets Wykrętaki do zerwanych śrub.....	79

Router bit sets Zestawy frezów do drewna



79

Diamond tools Narzędzia diamentowe



79-80

Diamond blades for cutting construction materials Tarcze diamentowe do cięcia materiałów budowlanych.....	79
Diamond rod saws Brzeszczoty diamentowe.....	80

Cutting & grinding discs Tarcze do cięcia i szlifowania



81-82

Metal cutting discs Tarcze do cięcia metalu.....	81
Metal grinding discs Tarcze do szlifowania metalu.....	81
Stone cutting discs Tarcze do cięcia kamienia.....	82
Stone grinding discs Tarcze do szlifowania kamienia.....	82

Flap discs Ściernice listkowe talerzowe



82

Chain discs Tarcze łańcuchowe



82

Grinding discs Tarcze do szlifierek stołowych



83

Shears Nożyce



83-85

Tin snips Nożyce do blachy.....	83
Figure tin snips „Juco” Nożyce do blachy „Juco”.....	84
Bolt cutters Nożyce do prętów.....	84

Saws & blades Piły i brzeszczoty



85-90

Hand saws Piły do drewna.....	85
Bow saws Piły kabłąkowe.....	85
Bow saw blades Brzeszczoty do pił kabłąkowych.....	86
Compass saws Piły otwornice.....	86
Saws for gas concrete Piły do gazobetonu.....	86
Hacksaw frames Piły do metalu.....	86
Cross cut saws Piły poprzeczne.....	87
Mitre saws Piły kątowe.....	87
Mitre boxes Skrzynki uciosowe.....	87
Blades Brzeszczoty.....	88



Jig saw blades
Brzeszczoty do wyrzynarek..... 89

Blades & jig saw blades ULTRA
Brzeszczoty ULTRA..... 90

Brushes, knives & files
Szczotki, noże i pilniki

90-100



Wire brushes
Szczotki druciane..... 90

Cup brushes
Szczotki tarczowe..... 90

Rubber discs
Tarcze gumowe do elektronarzędzi..... 92

Pocket knives
Noże składane..... 94

Window scrapers
Skrobaki do szyb..... 96

Glass cutters
Nożyki do cięcia szkła..... 96

Scrapers
Cykliny..... 97

Wood carving knife sets
Zestawy nożyków precyzyjnych..... 97

Scissors
Nożyczki..... 97

Punch sets
Komplety przebijaaków do skóry..... 97

Wood planes
Strugi..... 97

Steel files
Pilniki do metalu..... 98

Rasps
Tarniki do drewna..... 99

Abrasive products
Artykuły ścierne

100-102

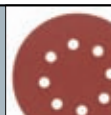

Sharpening stones
Oselki..... 100

Waterproof sand papers
Papiery ścierne wodoodporne..... 100

Abrasive clothes
Płótna ścierne..... 100

Abrasive meshes
Siatki ścierne..... 101

No end abrasive bands
Taśmy ścierne bezkońcowe..... 101

Abrasive sponges
Gąbki ścierne..... 101

Abrasive sheets and discs
Arkusze i krążki ścierne..... 101

Sanding blocks
Blokki ścierne..... 102

- PL Wiertło do metalu
- GB Twist drill bit
- D Spiralbohrer
- RUS Свёрло по металлу
- CZ Vrták na kov
- RO Burghiu pt. metal
- H Fúrószár fémhez
- E Broca para metalo



No.	Ø (mm)	pcs packing	
20100	1.0	10	200/10000
20150	1.5	10	200/8000
20200	2.0	10	200/8000
20250	2.5	10	200/4000
20280	2.8	10	200/4000
20300	3.0	10	200/4000
20320	3.2	10	200/4000
20350	3.5	10	100/4000
20400	4.0	10	100/4000
20420	4.2	10	100/2500
20430	4.3	10	100/2500
20450	4.5	10	100/2500
20500	5.0	10	100/2500
20550	5.5	10	100/2000
20600	6.0	10	50/1200
20650	6.5	10	50/1200
20700	7.0	10	50/1200
20800	8.0	5	50/600
20850	8.5	5	50/600
20900	9.0	5	50/600
21000	10.0	5	50/250
21100	11.0	5	50/250
21200	12.0	5	50/250
21250	12.5	5	50/250
21300	13.0	5	50/250
21400	14.0	5	50/200
21600	16.0	5	10/100

- PL Komplet wiertel do metalu
- GB Twist drill set
- D Spiralbohrersatz
- RUS Набор свёрл по металлу
- CZ Vrtáky na kov
- RO Burghie pt. metal
- H Fúrószár fémhez
- E Broca para metalo



No.	Ø (mm)	pcs	
22330	1.0; 1.5; 2.0; 2.5; 3.0; 3.5; 4.0; 4.5; 5.0; 5.5; 6.0; 6.5; 7.0; 7.5; 8.0; 8.5; 9.0; 9.5; 10.0	19	30
22340	1.0; 1.5; 2.0; 2.5; 3.0; 3.5; 4.0; 4.5; 5.0; 5.5; 6.0; 6.5; 7.0; 7.5; 8.0; 8.5; 9.0; 9.5; 10.0; 10.5; 11.0; 11.5; 12.0; 12.5; 13.0	25	20

- PL Komplet wiertel do metalu
- GB Twist drill set
- D Spiralbohrersatz
- RUS Набор свёрл по металлу
- CZ Vrtáky na kov
- RO Burghie pt. metal
- H Fúrószár fémhez
- E Broca para metalo



No.	Ø (mm)	pcs	
22130	1.5; 2.0; 2.5; 3.0; 3.2; 3.5; 4.0; 4.5; 4.8; 5.0; 5.5; 6.0; 6.5	13	25/100
22180	2.0; 2.5; 3.0; 3.5; 4.0; 4.5; 5.0; 5.5; 6.0; 6.5; 7.0; 7.5; 8.0	13	25/50

- PL Komplet wiertel do metalu
- GB Twist drill set
- D Spiralbohrersatz
- RUS Набор свёрл по металлу
- CZ Vrtáky na kov
- RO Burghie pt. metal
- H Fúrószár fémhez
- E Broca para metalo



No.	Ø (mm)	pcs	
22190	1.0; 1.5; 2.0; 2.5; 3.0; 3.5; 4.0; 4.5; 5.0; 5.5; 6.0; 6.5; 7.0; 7.5; 8.0; 8.5; 9.0; 9.5; 10.0	19	30
22250	1.0; 1.5; 2.0; 2.5; 3.0; 3.5; 4.0; 4.5; 5.0; 5.5; 6.0; 6.5; 7.0; 7.5; 8.0; 8.5; 9.0; 9.5; 10.0; 10.5; 11.0; 11.5; 12.0; 12.5; 13.0	25	20

- PL Komplet wiertel do metalu
- GB Twist drill set
- D Spiralbohrersatz
- RUS Набор свёрл по металлу
- CZ Vrtáky na kov
- RO Burghie pt. metal
- H Fúrószár fémhez
- E Broca para metalo



No.	Ø (mm)	pcs	
22300	1.5; 2.0; 2.5; 3.0; 3.2; 3.5; 4.0; 4.5; 4.8; 5.0; 5.5; 6.0; 6.5	13	25/100
22310	2.0; 2.5; 3.0; 3.5; 4.0; 4.5; 5.0; 5.5; 6.0; 6.5; 7.0; 7.5; 8.0	13	25/50

- PL Wiertło do metalu HSS
 GB HSS twist drill bit
 D Spiralbohrer HSS
 RUS Свёрло по металлу HSS
- CZ Vrták na kov HSS
 RO Burghiu pt. metal HSS
 H Fúrószár fémhez HSS
 E Broca para metalo HSS

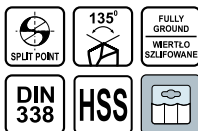

- PL Komplet wiertel do metalu
 GB Twist drill set
 D Spiralbohrersatz
 RUS Набор свёрл по металлу
 CZ Vrtáky na kov
 RO Burghie pt. metal
 H Fúrószár fémhez
 E Broca para metalo

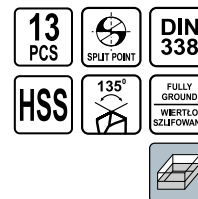

STHOR

No.	Ø (mm)	pcs	box
21998	2.0; 2.5; 3.0; 3.5; 4.0; 4.5; 5.0; 5.5; 6.0; 6.5; 7.0; 7.5; 8.0	13	10/50

- PL Komplet wiertel do metalu
 GB Twist drill set
 D Spiralbohrersatz
 RUS Набор свёрл по металлу
 CZ Vrtáky na kov
 RO Burghie pt. metal
 H Fúrószár fémhez
 E Broca para metalo

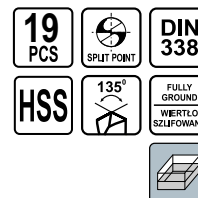

STHOR

No.	Ø (mm)	pcs	box
21999	1.0; 1.5; 2.0; 2.5; 3.0; 3.5; 4.0; 4.5; 5.0; 5.5; 6.0; 6.5; 7.0; 7.5; 8.0; 8.5; 9.0; 9.5; 10.0	19	5/30

- PL Wiertło do betonu
 GB Masonry drill bit
 D Betonbohrer
 RUS Свёрло по бетону
- CZ Vrták na beton
 RO Burghiu pt. beton
 H Fúrószár betonhoz
 E Broca para hormigon



STHOR

No.	Ø (mm)	L (mm)	box
23311	4	75	200/1600
23312	5	85	200/1600
23313	6	100	200/1000
23324	6	400	100/300
23314	7	100	200/1000
23315	8	120	100/500
23325	8	400	50/200
23316	10	120	100/500
23326	10	400	50/100
23317	12	150	50/200
23327	12	400	50/100
23318	14	150	50/150
23328	14	400	50/100
23319	16	150	50/150
23329	16	400	50/100
23320	18	150	50/150
23321	20	150	25/100

- PL Wiertła do betonu
 GB Masonry drill set
 D Betonbohrer
 RUS Набор свёрл по бетону
- CZ Souprava vrtáků do betonu
 RO Set de burghie pt. beton
 H Fúrószárkészlet betonhoz
 E Brocas para hormigon



No.	mm	L (mm)	pcs	box
23540	10; 12; 14	400	3	50

PL Wiertła do betonu
 GB Masonry drill set
 D Betonbohrer
 RUS Набор сверл по бетону
 CZ Souprava vrtáků do betonu
 RO Set de burghie pt. beton
 H Fúrószámkészlet betonhoz
 E Brocas para hormigon



5
PCS



STIHL

No.	mm	pcs	
23331	4; 5; 6; 8; 10	5	50/200

PL Wiertła do drewna
 GB Wood drill set
 D Holzbohrersatz
 RUS Набор сверел по дереву

CZ Vrtáky na dřevo
 RO Burghie pt. lemn
 H Fúró fához
 E Brocas para maderaz

5
PCS



No.	Ø (mm)	pcs	
22350	4; 5; 6; 8; 10	5	25/200

PL Wiertła do drewna
 GB Wood drill set
 D Holzbohrersatz
 RUS Набор сверел по дереву

CZ Vrtáky na dřevo
 RO Burghie pt. lemn
 H Fúró fához
 E Brocas para maderaz

8
PCS



STIHL

No.	Ø (mm)	pcs	
22380	3; 4; 5; 6; 7; 8; 9; 10	8	20/100

PL Wiertła do drewna
 GB Wood drill set
 D Holzbohrersatz
 RUS Набор сверел по дереву

CZ Vrtáky na dřevo
 RO Burghie pt. lemn
 H Fúró fához
 E Brocas para maderaz

8
PCS



STIHL

No.	Ø (mm)	pcs	
22381	3; 4; 5; 6; 7; 8; 9; 10	8	10/80

PL Wiertła do drewna
 GB Wood drill set
 D Holzbohrersatz
 RUS Набор сверел по дереву

CZ Vrtáky na dřevo
 RO Burghie pt. lemn
 H Fúró fához
 E Brocas para maderaz

6
PCS



STIHL

No.	Ø (mm)	L (mm)	pcs	
22460	6; 8; 10; 12; 13; 14	300	6	25

PL Wiertła do drewna
 GB Wood drill set
 D Holzbohrersatz
 RUS Набор сверел по дереву

CZ Vrtáky na dřevo
 RO Burghie pt. lemn
 H Fúró fához
 E Brocas para maderaz

6
PCS

230
mm



STIHL

No.	Ø (mm)	L (mm)	pcs	
22465	10; 12; 14; 16; 18; 20	230	6	10

PL Wiertła do drewna
 GB Wood drill set
 D Holzbohrersatz
 RUS Набор сверел по дереву

CZ Vrtáky na dřevo
 RO Burghie pt. lemn
 H Fúró fához
 E Brocas para maderaz

6
PCS

460
mm



STIHL

No.	Ø (mm)	L (mm)	pcs	
22466	10; 12; 14; 16; 18; 20	460	6	10

PL Wiertła do drewna, łopatkowe
 GB Flat wood bits
 D Holz-Flachfräsbohrersatz
 RUS Набор сверел по дереву

CZ Vrtáky na dřevo
 RO Burghie pt. lemn
 H Fúró fához
 E Brocas para maderaz

6
PCS



No.	Ø (mm)	pcs	
22500	10; 12; 16; 18; 20; 25	6	10/100

PL Wiertło do betonu
GB Masonry drill bit
D Betonbohrer
RUS Свёрло по бетону

CZ Vrták na beton
RO Burghiu pt. beton
H Fúrószár betonhoz
E Broca para hormigon

SDS PLUS



STHOR

No.	Ø (mm)	L (mm)	
23620	5	110	10/500
23640	6	110	10/500
23650	6	160	10/500
23660	6	210	10/300
23670	8	110	10/500
23680	8	160	10/400
23690	8	210	10/250
23692	8	300	10/200
23693	8	460	10/100
23694	8	600	10/100
23710	10	160	10/300
23720	10	210	10/250
23722	10	300	10/150
23723	10	460	10/100
23724	10	600	10/100
23730	12	160	10/300
23740	12	460	10/100
23750	12	266	10/150
23752	12	600	10/60
23800	14	166	10/200
23820	14	460	10/80
23830	14	266	10/150
23832	14	600	10/50
23840	16	200	10/160
23850	16	300	8/96
23860	16	460	8/48
23862	16	600	8/48
23880	18	300	8/72
23882	18	460	6/48
23883	18	600	6/48
23920	20	300	5/50
23930	20	450	5/50
23932	20	600	5/30
23960	22	460	5/25
23962	22	600	5/25
23980	25	300	5/50
23982	25	600	5/15
23990	25	460	5/25
23992	28	600	2/10
23999	30	600	2/10

PL Wiertło do betonu
GB Masonry drill bit
D Betonbohrer
RUS Свёрло по бетону

CZ Vrták na beton
RO Burghiu pt. beton
H Fúrószár betonhoz
E Broca para hormigon

SDS MAX



STHOR

No.	Ø (mm)	L (mm)	
23371	16	300	10/50
23390	16	600	5/30
23411	16	900	4/20
23372	18	300	10/50
23391	18	600	5/30
23412	18	900	4/20
23373	20	300	8/40
23392	20	600	4/20
23413	20	900	2/10
23374	22	300	6/30
23393	22	600	4/20
23414	22	900	2/10
23375	24	300	6/30
23394	24	600	4/20
23415	24	900	2/10
23376	25	300	6/30
23395	25	600	4/20
23416	25	900	2/10
23377	26	300	6/30
23396	26	600	2/10
23417	26	900	2/10
23378	28	300	4/20
23397	28	600	2/10
23418	28	900	5
23379	30	300	4/20
23398	30	600	2/10
23419	30	900	5
23380	32	300	4/20
23399	32	600	2/10
23420	32	900	5
23381	35	300	4/20
23400	35	600	2/10
23421	35	900	5
23382	37	300	4/20
23401	37	600	2/10
23422	37	900	5
23383	38	300	4/20
23402	38	600	2/10
23423	38	900	5
23403	40	600	5
23424	40	900	5

PL Komplet wiertel do betonu
GB Masonry drill set
D Betonbohrersatz
RUS Набор свёрл по бетону
CZ Souprava vrtáků do betonu
RO Set de burghie pt. beton
H Fúrószárkészlet betonhoz
E Juego de brocas

SDS PLUS



STHOR

No.	Ø mm	pcs	
23988	5; 6; 8; 10; 12x160	5	15/60

PL Grot SDS Plus
GB Point chisel
D Spitzmeißel
RUS Зубило пиковое

CZ Špičák
RO Dom
H Hegyes véső
E Cincel punta

SDS PLUS



STHOR

No.	Ø (mm)	L (mm)	
23590	14	250	25/50

PL Grot SDS Max
GB Point chisel
D Spitzmeißel
RUS Зубило пиковое

CZ Špičák
RO Dorn
H Hegyes véső
E Cíncel punta



STHOR

No.	Ø (mm)	L (mm)	
23601	18	280	20/40
23602	18	400	15/30

PL Dłuto wąskie SDS Plus
GB Flat chisel
D Flachmeißel
RUS Зубило узкое

CZ Sekáč
RO Dalta spatulată
H Lapos véső
E Cíncel plano



STHOR

No.	Ø (mm)	L (mm)	
23591	20x14	250	25/50

PL Dłuto wąskie SDS Max
GB Flat chisel
D Spatmeißel
RUS Зубило узкое

CZ Sekáč
RO Dalta spatulată
H Lapos véső
E Cíncel plano



STHOR

No.	Ø (mm)	L (mm)	
23603	25x18	280	20/40
23604	25x18	400	10/20

PL Dłuto szerokie SDS Plus
GB Spade chisel
D Spatmeißel
RUS Лопатка

CZ Sekáč plochy
RO Dalta
H Széles véső
E Cíncel pala



STHOR

No.	Ø (mm)	L (mm)	
23592	40x14	250	25/50

PL Dłuto szerokie SDS Max
GB Spade chisel
D Spatmeißel
RUS Лопатка

CZ Sekáč plochy
RO Dalta
H Széles véső
E Cíncel pala



STHOR

No.	Ø (mm)	L (mm)	
23605	40x18	280	20/40
23606	50x18	400	10/20

PL Bruzdownik SDS Plus
GB Groove chisel
D Nutenmeißel
RUS Зубило канавочное

CZ Sekáč GU ANRYD
RO Dalta canal
H Horonyvėső
E Cíncel acanalado



STHOR

No.	Ø (mm)	L (mm)	
23593	22x14	250	25/50

PL Bruzdownik SDS Max
GB Groove chisel
D Nutenmeißel
RUS Зубило канавочное

CZ Sekáč GU ANRYD
RO Dalta canal
H Horonyvėső
E Cíncel acanalado



STHOR

No.	Ø (mm)	L (mm)	
23608	25x18	400	10/20

PL Komplet wiertel i przecinaków do betonu
GB Hammer drill & chisel set
D Bohrer und Meißel Satz
RUS Набор сверл и зубил

CZ Souprava vrtáků + sekáče
RO Set de burghie + dalte tăietor
H Fűrészkészlet + hidegvágó
E Juego de cinceles y brocas



VOREL

No.	pcs	
23585	12	8

- PL Komplet wiertel i przecinaków do betonu
 GB Hammer drill & chisel set
 D Bohrer und Meißel Satz
 RUS Набор сверл и зубил
 CZ Souprava vrtáků + sekáče
 RO Set de burghie + dalte tăietor
 H Fúrószerkészlet + hidegvágó
 E Juego de cinceles y brocas

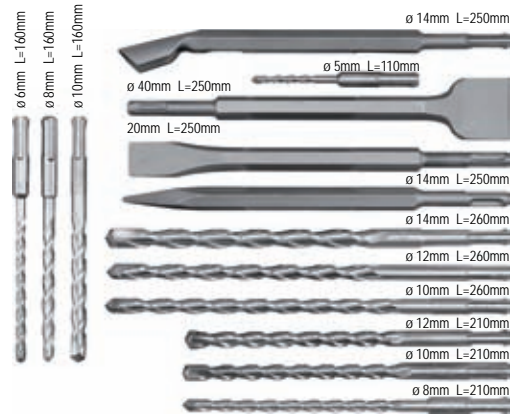

14
PCS

SDS
PLUS



No.	pcs	
23586	14	6

- PL Wiertło koronowe do muru
 GB Hollow drill set
 D Bohrkronen
 RUS Коронка по бетону
 CZ Korunový vrták na zeď - pouzdro šestiúhelník
 RO Burghiu cu coroană pt. beton - mandrină hexagonală
 H Koronafúró falhoz - hatszögletű szárral
 E Broca widla para muro

max 50 mm

HEX
13mm



No.	Ø (mm)	
03240	65	24
03241	80	20

- PL Wiertło koronowe do muru
 GB Hollow drill set
 D Bohrkronen
 RUS Коронка по бетону
 CZ Korunový vrták na zeď - pouzdro šestiúhelník
 RO Burghiu cu coroană pt. beton - mandrină hexagonală
 H Koronafúró falhoz - hatszögletű szárral
 E Broca widla para muro

SDS
PLUS

max 50 mm



No.	Ø (mm)	
03245	65	24
03246	80	20

- PL Wycinarka do płyt gipsowych
 GB Drywall circle cutter
 D Schnitzzirkel für Gipsplatten
 RUS Резак круговой по гипсокартону
- CZ Vystřihávačka pro sádrové desky
 RO Tăietoare pt. plăci de ghips
 H Gipszfalkivágó
 E Compas cortador para planchas de escayola

30-400
Ømm



No.	Ø (mm)	
03990	30-400	12/48

- PL Wycinarka otworów do drewna
 GB Hole saw set
 D Lochsägensatz
 RUS Пилы кольцевые по дереву в наборе
- CZ Vytínač otvorů
 RO Tăietor (ferăstrău rotund) pt. orificii
 H Lyukasztó
 E Sierra de corona para madera

4
PCS

Ø 51, 76, 89
mm

21mm
(max)

6mm

5000 min⁻¹



No.	Ø (mm)	pcs	
22565	51; 76; 89	4	12/48

- PL Wycinarka otworów do drewna
 GB Hole saw set
 D Lochsägensatz
 RUS Пилы кольцевые по дереву в наборе
 CZ Vytínač otvorů
 RO Tăietor (ferăstrău rotund) pt. orificii
 H Lyukasztó
 E Sierra de corona para madera

9
PCS

Ø (mm)
38, 51, 57
67, 76, 89
102, 127

6mm

5000 min⁻¹

21mm
(max)

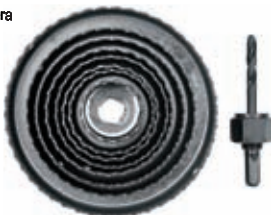

No.	Ø (mm)	pcs	
22572	38-127	9	6/24

- PL Zestaw wycinarek do otworów w drewnie
 GB Hole saw set
 D Lochsägensatz
 RUS Пилы кольцевые по дереву в наборе
- CZ Vytínač otvorů
 RO Tăietor (ferăstrău rotund) pt. orificii
 H Lyukasztó
 E Juego de sierras de corona

11
PCS

19-64
mm



No.	Ø (mm)	pcs	
22570	19-64	11	12/36

PL Zestaw wycinarek do otworów w drewnie
 GB Hole saw set
 D Lochsägensatz
 RUS Пилы кольцевые по дереву в наборе

CZ Vytínač otvorů
 RO Tăietor (ferăstrău rotund) pt. orificii
 H Lyukasztó
 E Juego de sierras de corona

8
PCS

64-127
mm



No.	Ø (mm)	pcs	
22571	64-127	8	6/36

PL Wyrzynarka do drewna, hartowane zęby
 GB Hole saw for wood with hardened teeth
 D Lochsägensatz
 RUS Пилы кольцевые по дереву закалённые зубья

CZ Vyřezávací pila kalená
 RO Set freze circulare cu dinti caliti
 H Szűrőfűrész edzett
 E Sierra de corona curtidó

7
PCS

5mm



No.	Ø (mm)	L (mm)	
28680	26; 32; 38; 45; 50; 56; 63	17	10/100
28690	26; 32; 38; 45; 50; 56; 63	45	10/80

PL Wyrzynarka do drewna
 GB Hole saw for wood
 D Lochsägensatz
 RUS Пилы кольцевые по дереву

CZ Vyřezávací pila
 RO Set freze decupat lemn
 H Szűrőfűrész
 E Sierra de corona

7
PCS

5mm



No.	Ø (mm)	L (mm)	
28710	26; 32; 38; 45; 50; 56; 63	17	10/100
28720	26; 32; 38; 45; 50; 56; 63	45	10/80

PL Zestaw wycinarek do otworów
 GB Hole saw set
 D Lochsägensatz
 RUS Пилы кольцевые по дереву

CZ Vytínač otvorů
 RO Set freze
 H Lyukasztó
 E Cortador de agujeros

8
PCS

Ø (mm)
60, 67, 74
81, 95

30mm
(max)

10mm

1500 min



No.	Ø (mm)	pcs	
28725	60; 67; 74; 81; 95	8	6/24

PL Otwornica do PCV
 GB PVC Hole cutter
 D PVC Lochmesser
 RUS Сверла по ПВХ

CZ Otvornice na PVC
 RO Dispozitiv decupat PVC
 H Lyukasztó PVC
 E Cortador de agujeros de PVC

3
PCS

30x120
Ømm

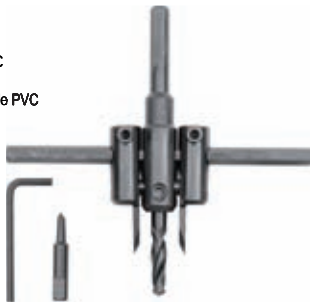

No.	Ø (mm)	pcs	
28733	30-120	3	6/60

PL Zestaw wycinarek wolframowych
 GB Tungsten carbide coated hole saw set
 D Lochbohrersatz
 RUS Диск с вольфрамовым напылением для порезки алюминия

CZ Sada děrovacích vrtáků pro keramiku
 RO Set freze + maner
 H Körkivógó készlet wolfram borítással
 E Juego de punzones de wolframio

4
PCS



No.	Ø (mm)	
03300	33; 53; 67; 73	20
03301	33; 53; 67; 83	20

PL Wiertło do szkła i glazury
 GB Tile and glass drill
 D Glass- und Fliesbohrer
 RUS Сверло по плитке и стеклу

CZ Vrták do skla a glazury
 RO Burghiu pt. sticlă și glazură
 H Üveg- és csempefúró
 E Broca para cristal y azulejos



No.	L (mm)	
05540	4	50/100
05560	6	50/100
05580	8	50/100
05600	10	50/100

PL Gwintowniki
 GB Hand taps
 D Handgewindebohrer
 RUS Метчик

CZ Závitníky
 RO Tarozl
 H Menetfúró
 E Machos de rosca

3
PCS



No.	M	pcs. packing	
24300	M3	3	25/100
24310	M4	3	25/100
24320	M5	3	25/100
24330	M6	3	25/100
24340	M7	3	25/100
24350	M8	3	25/100

PL Gwintowniki
GB Hand taps
D Handgewindebohrer
RUS Метчик

CZ Závítňky
RO Tarozl
H Menetűró
E Machos de rosca

3
PCS



No.	M	pcs packing	
24370	M10	3	25/100
24390	M12	3	25/100
24410	M14	3	20
24430	M16	3	20
24450	M18	3	20
24470	M20	3	20

PL Gwintownik maszynowy
GB Machine taps
D Maschinengewindebohrer
RUS Метчик машинный

CZ Strojň závítňk
RO Tarod de mašină
H Gépi menetűró
E Macho mecanico

HSS



No.	Ø M	
24960	M3	25/100
24961	M4	25/100
24962	M5	25/100
24963	M6	25/100
24964	M8	25/100
24965	M10	25/100
24966	M12	25/100

PL Narzynka
GB Circular die
D Schneideisen
RUS Плашка

CZ Kruhová závítová řelst
RO Filleră
H Menetűró
E Cojinetes de rosca



No.	Ø M	
24500	M3	25/100
24510	M4	25/100
24520	M5	25/100
24530	M6	25/100
24540	M7	25/100
24550	M8	25/100
24570	M10	25/100
24590	M12	25/100
24610	M14	25/100
24630	M16	15/60
24650	M18	15/30
24670	M20	15/60

PL Komplet gwintowników i narzynek
GB Tap and die set
D Gewindeschneidwerkzeugsatz
RUS Набор плашек и метчиков

CZ Souprava závítňků a kruhových závítových řelst
RO Set de tarozl și filiere
H Menetűró és menetűró készlet
E Juego de machos de rosca y cojinetes

32
PCS



No.	Ø M	pcs	
24900	M3; M4; M5; M6; M8; M10; M12	32	5

PL Komplet gwintowników
GB Hand tap set
D Innengewindebohrersatz
RUS Набор метчиков

CZ Souprava závítňků
RO Set de tarozl
H Menetűró készlet
E Juego de machos de rosca

25
PCS



No.	Ø M	pcs	
24940	M3; M4; M5; M6; M7; M8; M10; M12	25	60

PL Komplet narzynek
GB Die set
D Aussengewindeschneidesatz
RUS Набор плашек

CZ Souprava kruhových závítových řelst
RO Set de filiere
H Menetűró készlet
E Juego de cojinetes

9
PCS



No.	Ø M	pcs	
24950	M3; M4; M5; M6; M7; M8; M10; M12	9	60

PL Grzechtka do gwintownika
GB Ratchet tap wrench
D Gewindebohrerratsche
RUS Вороток для метчиков с трещоткой

CZ Řehtačka na závítňk
RO Chele cu clichet pt. tarod
H Racsnis hajlászár menetűróhoz
E Carraca para macho de rosca



No.	Ø M	
24700	M3-M8	25/100
24710	M5-M12	25/100

PL Pokrętko do gwintownika
GB Tap wrench
D Windeisen
RUS Вороток для метчиков

CZ Ovládací kolečko na závitník
RO Cheie (măner) pt. tarod
H Hajtószer menetíűrhoz
E Llave gramachos



No.	Ø M	L (mm)	
24730	M4-M8	200	30
24740	M9-M12	285	25
24750	M13-M18	440	20

PL Oprawka do narzynek
GB Die holder
D Schneideisenhalter
RUS Плашкодержатель

CZ Závitová objímka
RO Portfilieră
H Menetvágó tartó
E Portacojinete



No.	mm	L (mm)	
24800	20x7	195	30
24810	25x9	230	25
24813	30x11	260	25
24820	38x14	310	30
24823	45x16	390	20

PL Komplet gwintowników i narzynek
GB Tap and die set
D Gewindeschneidwerkzeugsatz
RUS Набор плашек и метчиков

CZ Souprava závitníků a kruhových závitových čelistí
RO Set de tarozi și filiere
H Menetíűró és menetvágó készlet
E Juego de machos de rosca y cojinetes



No.	Ø M	
24295	M3x0.5; M4x0.7; M5x0.8; M6x1; M8x1.25; M10x1.5; M12x1.75	10/20

PL Wykrętki do zerwanych śrub
GB Screw extractor set
D Schraubensatz
RUS Экстракторы обломанных болтов

CZ Vrtáky do přímých a špičkových šroubů
RO Set extractoare pt. prezoane / suruburi
H Törtsavar kihajító
E Destornillador para tornillos arrancados



No.	size / rozmiar	pcs	
24000	1/8" (3.2 mm) - 1/4" (6.3 mm) 1/4" (6.3 mm) - 5/16" (7.9 mm) 5/16" (7.9 mm) - 7/16" (11.1 mm) 7/16" (11.1 mm) - 9/16" (14.3 mm) 9/16" (14.3 mm) - 3/4" (19.0 mm)	5	12/120

PL Komplet frezów do drewna
GB Router bit set
D Oberfräsersatz
RUS Набор фрез по дереву

CZ Souprava frézů do dřeva
RO Set de freze pt. lemn
H Marókéskészlet fához
E Juego de frezas para madera



No.	Ø (mm)	pcs	
22550	8	12	5/20

PL Komplet frezów do drewna
GB Router bit set
D Oberfräsersatz
RUS Набор фрез по дереву

CZ Souprava frézů do dřeva
RO Set de freze pt. lemn
H Marókéskészlet fához
E Juego de frezas para madera



No.	L (mm)	Ø (mm)	pcs	
22551	15; 20; 25; 30; 35	8	5	5/20

PL Tarcza diamentowa "segment"
GB Diamond blade segmented
D Diamantrennscheibe
RUS Диск алмазный сегментированный

CZ Diamantový kotouč segmentový
RO Disc diamantat segmentat
H Szegmens gyémántkorong
E Disco de diamante de segmentos



No.	Ø (mm)	min-1	
08710	110	12000	20/200
08711	115	12000	20/200
08712	125	11000	20/160
08714	180	8000	15/60
08715	230	6500	10/40



PL Tarcza diamentowa "segment"
 GB Diamond blade segmented
 D Diamantrennscheibe
 RUS Диск алмазный сегментированный

CZ Diamantový kotouč segmentový
 RO Disc diamantat segmentat
 H Szegmens gyémántkorong
 E Disco de diamante de segmentos



STORZ

No.	Ø (mm)	min-1	
08780	115x7.0x1.9x22.2	13200	20/120
08781	125x7.0x2.0x22.2	12000	20/120
08782	180x7.0x2.3x22.2	8400	15/45
08783	230x7.0x2.4x22.2	6600	10/30

PL Tarcza diamentowa pełna
 GB Diamond blade continuous rim
 D Diamantrennscheibe
 RUS Диск алмазный сплошной

CZ Diamantový kotouč /plný/
 RO Disc diamantat margine continua
 H Gyémántkorong /teljes/
 E Disco de diamante /entero/



VOREL

No.	Ø (mm)	min-1	
08731	115	12000	20/200
08732	125	11000	20/160
08734	180	8000	15/60
08735	230	6500	10/40

PL Tarcza diamentowa pełna
 GB Diamond blade continuous rim
 D Diamantrennscheibe
 RUS Диск алмазный сплошной

CZ Diamantový kotouč /plný/
 RO Disc diamantat margine continua
 H Gyémántkorong /teljes/
 E Disco de diamante /entero/



STORZ

No.	Ø (mm)	min-1	
08785	115x5.0x1.9x22.2	13200	20/120
08786	125x5.0x2.0x22.2	12000	20/120
08787	180x5.0x2.3x22.2	8400	15/45
08788	230x5.0x2.4x22.2	6600	10/30

PL Tarcza diamentowa „Turbo“
 GB Diamond blade „Turbo“
 D Diamantrennscheibe lb
 RUS Отрезной алмазный диск „TURBO“

CZ Diamantový kotouč /Turbo/
 RO Disc diamantat Turbo
 H Gyémántkorong /Turbo/
 E Disco de diamante /Turbo/



VOREL

No.	Ø (mm)	min-1	
08751	115	12000	20/200
08752	125	11000	20/160
08754	180	8000	15/60
08755	230	6500	10/40

PL Tarcza diamentowa „Turbo“
 GB Diamond blade „Turbo“
 D Diamantrennscheibe lb
 RUS Отрезной алмазный диск „TURBO“

CZ Diamantový kotouč /Turbo/
 RO Disc diamantat Turbo
 H Gyémántkorong /Turbo/
 E Disco de diamante /Turbo/



STORZ

No.	Ø (mm)	min-1	
08790	115x7.0x2.0x22.2	13200	20/120
08791	125x7.0x2.1x22.2	12000	20/120
08792	180x7.5x2.4x22.2	8400	15/45
08793	230x7.5x2.6x22.2	6600	10/30

PL Brzeszczot diamentowy
 GB Diamond rod saw
 D Diamantsägekordel
 RUS Полотно алмазное

CZ Lanko plove diamantowe
 RO Panze diamantate
 H Fűrészlap-pálca, gyémántbevonatú
 E Hoja de sierra de diamante

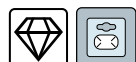

VOREL

No.	L (mm)	
27575	300	20/100

PL Tarcza do cięcia metalu
GB Metal cutting disc
D Trennscheibe für metall
RUS Диск отрезной по металлу

CZ Souprava kotoučů pro řezání kovu
RO Set de pânze de tăiat metal
H Vágókorong készlet fémhez
E Disco cortador para metal plano



VOREL

No.	Ø (mm)	min-1	
08630	115x1.0x22	12000	25/200
08633	115x2.5x22	13300	25/200
08631	125x1.0x22	11000	25/200
08635	125x2.5x22	12200	25/200
08636	125x3.2x22	12200	25/200
08638	180x2.5x22	8500	25/100
08639	230x1.6x22	6600	25/50
08640	230x3.2x22	6600	25/50
08641	230x2.5x22	6600	25/50
08642	300x3.2x32	5100	10/20
08644	350x3.5x32	4400	10/20
08646	400x4.0x32	3800	10/20

PL Tarcza do cięcia metalu
GB Metal cutting disc
D Trennscheibe für metall
RUS Диск отрезной по металлу

CZ Souprava kotoučů pro řezání kovu
RO Set de pânze de tăiat metal
H Vágókorong készlet fémhez
E Disco cortador para metal plano



STOR

No.	Ø (mm)	min-1	
08170	115x1.0x22	13200	25/200
08174	115x3.0x22	13200	25/200
08171	125x1.0x22	12200	25/200
08175	125x3.0x22	12200	25/200
08177	230x3.0x22	6500	25/50

PL Tarcza do cięcia metalu wypukła
GB Metal cutting disc – depressed centre
D Metall-Trennscheibe gewölbt
RUS Диск отрезной по металлу торцевой

CZ Souprava kotoučů pro řezání kovu
RO Set de pânze de tăiat metal
H Vágókorong készlet fémhez
E Disco cortador para metalo concavo



VOREL

No.	Ø (mm)	min-1	
08655	115x3.2x22	13300	25/200
08656	125x3.2x22	12200	25/200
08658	230x3.2x22	6600	25/50

PL Tarcza do szlifowania metalu wypukła
GB Metal grinding disc - depressed centre
D Metall-Schleifscheibe gewölbt
RUS Диск шлифовальный по металлу

CZ Kotouč pro broušení kovu
RO Disc pt. șlefuit metal
H Vágókorong fémhez
E Disco de pulir de metalo



VOREL

No.	Ø (mm)	min-1	
08663	115x6.0x22	13300	25/100
08665	125x6.8x22	11000	25/100
08669	230x6.8x22	6600	25/50

PL Tarcza do cięcia metalu wypukła
GB Metal cutting disc – depressed centre
D Metall-Trennscheibe gewölbt
RUS Диск отрезной по металлу торцевой

CZ Souprava kotoučů pro řezání kovu
RO Set de pânze de tăiat metal
H Vágókorong készlet fémhez
E Disco cortador para metalo concavo



STOR

No.	Ø (mm)	min-1	
08185	115x3.0x22	13200	25/200
08186	125x3.0x22	12200	25/200
08188	230x3.0x22	6500	25/50

PL Tarcza do szlifowania metalu wypukła
GB Metal grinding disc - depressed centre
D Metall-Schleifscheibe gewölbt
RUS Диск шлифовальный по металлу

CZ Kotouč pro broušení kovu
RO Disc pt. șlefuit metal
H Vágókorong fémhez
E Disco de pulir de metalo



STOR

No.	Ø (mm)	min-1	
08190	115x6.0x22	13200	25/100
08191	125x6.0x22	12200	25/100
08193	230x6.0x22	6500	10/20

PL Tarcza do cięcia kamienia
GB Stone cutting disc
D Stein-Trennscheibe
RUS Диск отрезной по камню

CZ Kotouč pro řezání kamene
RO Disc pt. tăiat piatră
H Vágókorong kőhöz
E Disco cortador de piedra



VOREL

No.	Ø (mm)	min-1	
08671	115x3.2x22	13200	25/200
08672	125x3.2x22	12200	25/200
08674	230x3.2x22	6600	25/50

PL Tarcza do cięcia kamienia wypukła
GB Stone cutting disc - depressed centre
D Stein-Trennscheibe gewölbt
RUS Диск отрезной по камню

CZ Kotouč pro řezání kamene
RO Disc pt. tăiat piatră
H Vágókorong kőhöz
E Disco cortador de piedra



STMOR

No.	Ø (mm)	min-1	
08200	115x3.0x22	13200	25/200
08201	125x3.0x22	12200	25/200
08203	230x3.0x22	6500	25/50

PL Tarcza do szlifowania kamienia wypukła
GB Stone grinding disc - depressed centre
D Stein-Schleifscheibe gewölbt
RUS Диск шлифовальный по камню

CZ Kotouč pro broušení kamene
RO Disc pt. șlefuit piatră
H Csiszolókorong kőhöz
E Disco de pulir de piedra



VOREL

No.	Ø (mm)	min-1	
08681	115x6.0x22	13300	25/100
08683	125x6.8x22	11000	25/100

PL Ścierałka listkowa talerzowa
GB Abrasive disc
D Lameller
RUS Диск наждачный лепестковый

CZ Kotouč brusný lamelový
RO Disc abraziv
H Lamellás csiszoló
E Disco abrasivo



VOREL

No.	type	Ø (mm)	min-1	
07974	P40	115	13300	50/200
07975	P60	115	13300	50/200
07976	P80	115	13300	50/200
07977	P100	115	13300	50/200
07978	P120	115	13300	50/200
07984	P40	125	12300	50/200
07985	P60	125	12300	50/200
07986	P80	125	12300	50/200
07987	P100	125	12300	50/200
07988	P120	125	12300	50/200

PL Tarcza łańcuchowa
GB Chain disc
D Kettentrennscheibe
RUS Круг отрезной цепной

CZ Řetězové kolo
RO Disc circular pt. lemn
H Lánctárcsa
E Disco de cadena



VOREL

No.	Ø (mm)	min-1	
08770	115	12000	10
08771	125	11000	10
08773	230	6800	10

PL Tarcza do szlifierki stołowej
 GB Grinding disc
 D Schleifscheibe
 RUS Круг для настольного фрезерного станка

CZ Brusný kotouč
 RO Discul abraziv
 H Kőszűrőkö
 E Disco abrasivo



No.	Ø (mm)	min-1		
08860	125x12.7x17	5850	coarse-grained / gruboziarnisty	10
08861	125x12.7x17	5850	fine-grained / drobnoziarnisty	10
08864	150x12.7x16	5350	coarse-grained / gruboziarnisty	10
08865	150x12.7x17	5350	fine-grained / drobnoziarnisty	10
08868	150x31.75x25	5350	coarse-grained / gruboziarnisty	10
08869	150x31.75x25	5350	fine-grained / drobnoziarnisty	10
08872	200x15.88x20	3850	coarse-grained / gruboziarnisty	10
08873	200x15.88x20	3850	fine-grained / drobnoziarnisty	10
08875	200x31.75x30	3850	fine-grained / drobnoziarnisty	10

PL Tarcza do szlifierki stołowej
 GB Grinding disc
 D Schleifscheibe
 RUS Круг для настольного фрезерного станка

CZ Brusný kotouč
 RO Discul abraziv
 H Kőszűrőkö
 E Disco abrasivo



No.	Ø (mm)	min-1	
08876	200x20x40	3850	5

PL Nożyce do blachy
 GB Figure tin snips
 D Blechscher
 RUS Ножницы по металлу

CZ Nůžn CDSØFK
 RO Foarfece pt. tablă
 H Lemezvágo olló
 E Tijeras para hojalata



No.	max (mm)	
48000	1.5	6/36

PL Nożyce do blachy
 GB Figure tin snips
 D Blechscher
 RUS Ножницы по металлу

CZ Nůžn CDSØFK
 RO Foarfece pt. tablă
 H Lemezvágo olló
 E Tijeras para hojalata



No.	max (mm)	
48050	1.5	6/36

PL Nożyce do blachy
 GB Figure tin snips
 D Blechscher
 RUS Ножницы по металлу

CZ Nůžn CDSØFK
 RO Foarfece pt. tablă
 H Lemezvágo olló
 E Tijeras para hojalata



No.	max (mm)	
48060	1.2	6/48

PL Nożyce do blachy
 GB Figure tin snips
 D Blechscher
 RUS Ножницы по металлу

CZ Nůžn CDSØFK
 RO Foarfece pt. tablă
 H Lemezvágo olló
 E Tijeras para hojalata



No.	max (mm)	
48070	1.2	6/48

PL Nożyce do blachy
 GB Figure tin snips
 D Blechscher
 RUS Ножницы по металлу

CZ Nůžn CDSØFK
 RO Foarfece pt. tablă
 H Lemezvágo olló
 E Tijeras para hojalata

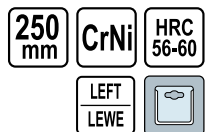

No.	L (mm)	
48080	250	6/36

PL Nożyce do blachy
GB Figure tin snips
D Blechscherer
RUS Ножницы по металлу

CZ Nůžn CD SØFK
RO Foarfece pt. tablă
H Lemezvágó olló
E Tijeras para hojalata

250 mm CrNi HRC 56-60
RIGHT PRAWO



No.	L (mm)	
48081	250	6/36

PL Nożyce do blachy
GB Figure tin snips
D Blechscherer
RUS Ножницы по металлу

CZ Nůžn CD SØFK
RO Foarfece pt. tablă
H Lemezvágó olló
E Tijeras para hojalata

250 mm CrNi HRC 56-60
STRAIGHT PROSTE



No.	L (mm)	
48082	250	6/36

PL Nożyce do blachy
GB Figure tin snips
D Blechscherer
RUS Ножницы по металлу

CZ Nůžn CD SØFK
RO Foarfece pt. tablă
H Lemezvágó olló
E Tijeras para hojalata

3 PCS STRAIGHT PROSTE
RIGHT PRAWO LEFT LEWE



No.	L (mm)	pcs	
48330	250	3	5/20

PL Nożyce do blachy
GB Figure tin snips
D Blechscherer
RUS Ножницы по металлу

CZ Nůžn CD SØFK
RO Foarfece pt. tablă
H Lemezvágó olló
E Tijeras para hojalata

LEFT LEWE



No.	L (mm)	
48100	250	6/60

PL Nożyce do blachy
GB Figure tin snips
D Blechscherer
RUS Ножницы по металлу

CZ Nůžn CD SØFK
RO Foarfece pt. tablă
H Lemezvágó olló
E Tijeras para hojalata

STRAIGHT PROSTE



No.	L (mm)	
48200	250	6/60

PL Nożyce do blachy
GB Figure tin snips
D Blechscherer
RUS Ножницы по металлу

CZ Nůžn CD SØFK
RO Foarfece pt. tablă
H Lemezvágó olló
E Tijeras para hojalata

RIGHT PRAWO



No.	L (mm)	
48150	250	6/60

PL Nożyce do blachy
GB Figure tin snips
D Blechscherer
RUS Ножницы по металлу

CZ Nůžn CD SØFK
RO Foarfece pt. tablă
H Lemezvágó olló
E Tijeras para hojalata

260 mm STRAIGHT PROSTE



No.	L (mm)	
48530	260	10/50

PL Nożyce do drutu
GB Bolt cutter
D Drahtschere
RUS Болторез

CZ Nůžn CD GJW
RO Cleste pt. buioane
H Drótvágó olló
E Tijeras para alambre

200 mm



No.	L (mm)	
49200	200	60

PL Głowica do nożyc do drutu
GB Bolt cutter head
D Schneiden für bolzenschneider
RUS Головка для болтореза

CZ Hlava nůžnic do drátu
RO Cap pt. cleste buloane
H Fej a kábelvágó ollóhoz
E Cabezal de tijeras para barras



No.	L (mm)	for / dia	
49460	450	49450	10/30
49610	600	49600	10/30
49760	750	49750	5/20

PL Nożyce do prętów
GB Bolt cutter
D Bolzenschneider
RUS Болторез

CZ Nůžnice do drátu
RO Cleste pt. buloane
H Kábelvágó olló
E Tijeras para barras



No.	L (mm)	
49450	450	20
49600	600	10
49750	750	5

PL Nożyce do prętów profesjonalne
GB Bolt cutter
D Bolzenschneider
RUS Болторез „ПРОФИ”

CZ Nůžnice do drátu
RO Cleste pt. buloane
H Kábelvágó olló
E Tijeras para barras



No.	L (mm)	Ø (mm)	
49770	350	6	24
49771	450	8	12
49772	600	10	12
49773	750	12	6
49774	900	14	4
49775	1050	16	2

PL Pila do drewna
GB Hand saw for wood
D Handsäge
RUS Пила по дереву

CZ Pila na dřevo
RO Fierastrău „coada de vulpe” - pt. lemn
H Fafűrész, egyenes
E Sierra de mano



No.	L (mm)	
28380	400	10/40
28381	450	10/40
28382	500	10/40

PL Pila płatnica
GB Hand saw for wood
D Handsäge
RUS Пила по дереву
CZ Pila na dřevo
RO Fierastrău „coada de vulpe” - pt. lemn
H Fafűrész, egyenes
E Sierra de mano



No.	L (mm)	
28385	400	12/48
28386	450	10/40
28387	500	10/40

PL Pila do drewna
GB Hand saw for wood
D Handsäge
RUS Пила по дереву

CZ Pila na dřevo
RO Fierastrău „coada de vulpe” - pt. lemn
H Fafűrész, egyenes
E Sierra de mano



No.	L (mm)	
28394	400	12/60
28395	450	12/60

PL Pila kablakowa
GB Bow saw
D Bűgelsäge
RUS Лучковая пила

CZ Oblouková pila
RO Ferăstrău de curbură
H Keretes fűrész
E Sierra de arco



No.	L (mm)	
28740	515	24
28750	735	24

PL Pila kablakowa
GB Bow saw
D Bűgelsäge
RUS Лучковая пила

CZ Oblouková pila
RO Ferăstrău de curbură
H Keretes fűrész
E Sierra de arco



No.	L (mm)	
28745	530	12/24

PL Pila kablakowa
GB Bow saw
D Bügelsäge
RUS Лучковая пила

CZ Oblouková pila
RO Ferăstrău de curbură
H Keretes fűrész
E Sierra de arco



No.	L (mm)	
28746	610	12/24
28755	760	12/24
28757	900	12/24

PL Brzeszczot
GB Spare blade for bow saw
D Bügelsägeblatt
RUS Полотно для пилы „Лидер”

CZ Ostří na dřevo
RO Panza fierastrau tip arc
H Fűrészlap fához
E Hoja de sierra

WET WOOD

DREWNÓ MOKRE



No.	L (mm)	W (mm)	
28771	530	20	60/240
28772	610	20	60/240
28773	760	20	60/240
28775	900	20	60/240

PL Pila otwornica
GB Compass saw
D Astsäge
RUS Пила выкружная

CZ Pila otvornice
RO Ferăstrău coadă de șoarece
H Lyukfűrész
E Sierra compas

300 mm



No.	L (mm)	
28650	300	30/120

PL Pila do gazobetonu
GB Saw for gas concrete
D Gasbetonsäge
RUS Пила по газобетону

CZ Pila na plynobeton
RO Fierastrau cu placute vidia pt. BCA
H Fűrész gázbetonhoz
E Sierra para gas hormigon

600 mm



No.	L (mm)	teeth / zęby	
28000	600	33/33	5
28010	600	33/17	5

PL Pila do gazobetonu
GB Saw for gas concrete
D Gasbetonsäge
RUS Пила по газобетону

CZ Pila na plynobeton
RO Fierastrau cu placute vidia pt. beton
H Fűrész gázbetonhoz
E Sierra para gas hormigon



No.	L (mm)	teeth / zęby	
28011	600	15	6/12
28012	660	34	6/12

PL Pila do metalu
GB Hacksaw frame
D Metallsägebogen
RUS Ножовка по металлу

CZ Pila na kov
RO Ferăstrău pt. metal
H Fémfűrész
E Sierra de metalo

300 mm



No.	L (mm)	
27000	300	12/48

PL Pila do metalu
GB Hacksaw frame
D Metallsägebogen
RUS Ножовка по металлу

CZ Pila na kov
RO Ferăstrău pt. metal
H Fémfűrész
E Sierra de metalo

300 mm



No.	L (mm)	
27100	300	12/60

PL Pila do metalu
GB Hacksaw frame
D Metallsägebogen
RUS Ножовка по металлу

CZ Pila na kov
RO Ferăstrău pt. metal
H Fémfűrész
E Sierra de metalo

300 mm



No.	L (mm)	
27200	300	20/60

PL Pila do metalu
GB Hacksaw frame
D Metallsägebogen
RUS Ножовка по металлу

CZ Pila na kov
RO Ferăstrău pt. metal
H Fémfűrész
E Sierra de metalo

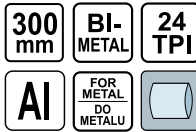

No.	L (mm)	Icon
27322	300	6/36

PL Pila do metalu
GB Hacksaw frame
D Metallsägebogen
RUS Ножовка по металлу

CZ Pila na kov
RO Ferăstrău pt. metal
H Fémfűrész
E Sierra de metalo



No.	L (mm)	Icon
27495	300	5

PL Pila do metalu
GB Hacksaw frame
D Metallsägebogen
RUS Ножовка по металлу

CZ Pila na kov
RO Ferăstrău pt. metal
H Fémfűrész
E Sierra de metalo



No.	L (mm)	Icon
27600	150	30/150

PL Pila poprzeczna
GB Cross - cut saw
D Bauchsäge
RUS Пила двуручная

CZ Pila břichatka
RO Joagar
H Keresztvágó fűrész
E Sierra para corte cruzado



No.	L (cm)	type	Icon
28790	100	L-1000	10

PL Pila kątowa
GB Precision mitre saw
D Präzisionsgehrungssäge
RUS Стусло металлическое „ПРОФИ“

CZ Úhlová pila
RO Fierastru pt. talat la unghi
H Kézfűrész
E Sierra de angulo



No.	mm	angle / kąť	Icon
29000	550	22.5°; 30°; 36°; 45°; 90°	1

PL Pila kątowa uchylna - 2 kąty cięcia
GB Precision mitre saw - 2 angles
D Präzisionsgehrungssäge kippbar
RUS Стусло металлическое наклонное „ПРОФИ“

CZ Úhlová pila sklápěcí
RO Fierastru de talat la unghi in doua plane
H Kézfűrész, döntött
E Sierra de angulo desviabile
2 angulos de corte



No.	mm	angle / kąť	Icon
29050	550	45°; 55°; 60°; 72°; 90°	1

PL Drewniana skrzynka uciosowa
GB Wooden mitre box
D Gehrungsschneidlade
RUS Стусло деревянное

CZ Ustřihací skříňka dřevěná
RO Cutie din lemn pt. tăiat oblic
H Vágószablon fa
E Gră de îngletar de maderă



No.	box / skrzynka (mm)	Icon
29210	300x80	10
29220	450x110	12

PL Skrzynka uciosowa
GB Plastic mitre box
D Schneidlade
RUS Стусло пластмассовое

CZ Ustřihací skříňka z umělé hmoty
RO Cutie din plastic pt. tăiat oblic
H Vágószablon műanyag
E Gră de îngletar de plastic



No.	box / skrzynka (mm)	Icon
29311	250x45	70
29312	285x60	50

PL Skrzynka uciosowa
GB Plastic mitre box
D Schneidlade
RUS Крышко пластмассовое

CZ Ustříhací skříňka z umělé hmoty
RO Cutie din plastic pt. tăiat oblic
H Vágószablon műanyag
E Gria de ingletar de plastic



No.	box / skrzynka (mm)	
29313	280x90	30

PL Skrzynka uciosowa
GB Plastic mitre box
D Schneidlade
RUS Крышко пластмассовое

CZ Ustříhací skříňka z umělé hmoty
RO Cutie din plastic pt. tăiat oblic
H Vágószablon műanyag
E Gria de ingletar de plastic



No.	box / skrzynka (mm)	
29317	230x50	50
29318	250x65	50
29319	290x85	30

PL Brzeczczoty
GB Hacksaw spare blades
D Metallsägeblatt
RUS Полотно двустороннее

CZ Čepele
RO Pânze
H Fémfűrészlap
E Hojas

300 mm



No.	type	L (mm)	W (mm)	pcs packing	
27500	RAMB	300	25	72	10



No.	type	L (mm)	W (mm)	pcs packing	
27501	RAMC	300	12	144	10



No.	type	L (mm)	W (mm)	pcs packing	
27502	RAMA	300	12	144	10



No.	type	L (mm)	W (mm)	pcs packing	
27505	RAME	300	20	72	10



No.	type	L (mm)	W (mm)	pcs packing	
27506	RAMF	300	20	72	10



No.	type	L (mm)	W (mm)	pcs packing	
27510	RAMD	300	25	72	10



No.	type	L (mm)	W (mm)	pcs packing	
27511	RAMB	300	25	3	50



No.	type	L (mm)	W (mm)	pcs packing	
27513	RAMD	300	25	3	50

PL Skrzynka uciosowa
GB Plastic mitre box
D Schneidlade
RUS Крышко пластмассовое

CZ Ustříhací skříňka z umělé hmoty
RO Cutie din plastic pt. tăiat oblic
H Vágószablon műanyag
E Gria de ingletar de plastic

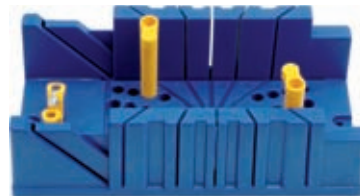

No.	box / skrzynka (mm)	
29323	325x125	18

PL Brzeczczoty do metalu
GB Spare blade for precision mitre saw for metal
D Metallsägeblatt
RUS Полотно для ножовки по металлу
CZ Pilový list na kovy
RO Panza fierastrau metale o fata taletoare
H Fémfűrész lap
E Hoja de sierra para metal

12 PCS 300 mm



No.	L (mm)	pcs packing	
27520	300	12	12/120

PL Brzeczczoty
GB Hacksaw spare blades
D Metallsägeblatt
RUS Полотно по металлу для мини-ножовки

CZ Čepele
RO Pânze
H Fémfűrészlap
E Hojas

10 PCS 150 mm



No.	L (mm)	pcs packing	
27800	150	10	30/240

PL Brzeszczot do drewna i PCV
 GB Spare blade for precision mitre saw for wood & PVC
 D PVC und holzsägeblatt
 RUS Полотно по дереву и ПВХ
 CZ Pilový list na dřevo a PVC
 RO Panza fierastrau pt. lemn si PVC
 H Fűrészlap fához és PVC-hez
 E Hoja de sierra para madera y PVC



No.	L (mm)	W (mm)	mm	teeth / inch zęby / cal	pcs
29090	550	45	0.7	18	50

PL Brzeszczot do metalu
 GB Spare blade for precision mitre saw for metal
 D Metallsägeblatt
 RUS Полотно по металлу
 CZ Pilový list na kovy
 RO Panza fierastrau pt. metal
 H Fémfűrész lap
 E Hoja de sierra para metalo

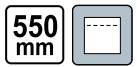

No.	L (mm)	W (mm)	mm	teeth / inch zęby / cal	pcs
29100	550	45	0.7	32	50

PL Brzeszczoty do wyrzynarki elektrycznej
 GB Jig saw blades
 D Stichsägeblätter
 RUS Полотно для электролобзика

CZ Pilový list do přímočaré pily
 RO Panza fierastrau circular
 H Dekopírlap
 E Recambio sierra de calar



No.	mm	pcs packing	pcs
27810	100/75	5	100/400



No.	mm	pcs packing	pcs
27811	100/75	5	100/400



No.	mm	pcs packing	pcs
27812	100/75	5	100/400



No.	mm	pcs packing	pcs
27813	100/75	5	100/400



No.	mm	pcs packing	pcs
27814	76/50	5	100/400



No.	mm	pcs packing	pcs
27815	100/75	5	100/400



No.	mm	pcs packing	pcs
27820	4x100/75; 1x76x50	5	100/400

PL Brzeszczoty do wyrzynarki elektrycznej
 GB Jig saw blades
 D Stichsägeblätter
 RUS Полотно для электролобзика

CZ Pilový list do přímočaré pily
 RO Panza fierastrau circular
 H Dekopírlap
 E Recambio sierra de calar



No.	mm	pcs packing	pcs
27830	100/75	5	100/400



No.	mm	pcs packing	pcs
27831	100/75	5	100/400



No.	mm	pcs packing	pcs
27832	76/50	5	100/400



No.	mm	pcs packing	pcs
27833	100/75	5	100/400



No.	pcs mm	pcs packing	pcs
27834	4x100/75; 1x76/50	5	100/400

PL Brzeszczot kobaltowy
 GB CO-HSS hacksaw spare blade
 D Kobaltklinge
 RUS Полотно кобальт

CZ Pílový list kobaltový
 RO Panze fierastrau
 H Kobalt fűrészlap
 E Filo de cobalto



No.	mm		
UBIHA	12x300	ULTRA	100

PL Brzeszczot uniwersalny
 GB Universal hacksaw spare blade
 D Universalklinge
 RUS Полотно универсальный

CZ Pílový list univerzální
 RO Panze fierastrau
 H Unverzális fűrészlap
 E Filo universal



No.	mm		
UFLEX	12x300	ULTRA	100

PL Szczotka druciana
 GB Steel wire brush
 D Stahldrahtbürste
 RUS Щетка проволочная стальная

CZ Drátěný kartáč
 RO Perie de sármă
 H Drótkefe
 E Cepillo de acero



No.	rows / rzędy	
06930	3	12/120
06940	4	12/120
06950	5	12/120
06960	6	12/120

PL Komplet szczotek drucianych
 GB Plastic handle wire brush set
 D Stahldrahtensatz
 RUS Набор 3-х мини-щёток

CZ Kartáče
 RO Perie set
 H 3 db-os kefékészlet
 E Juego de 3 cepillos

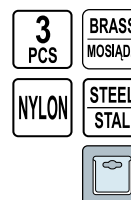

No.	L (mm)	
06963	170	24/240
06964	220	24/72

PL Szczotka druciana mosiężna
 GB Brass wire brush
 D Messingdrahtbürste
 RUS Щетка проволочная латунная

CZ Drátěný kartáč mosazný
 RO Perie de sármă din alamă
 H Réz drótkefe
 E Cepillo de laton



No.		
06965		25/100

PL Szczotka czolowa z gwintem, drut karbowany
 GB Cup brush - crimped wire
 D Stahldraht-Zopftopfbürste
 RUS Щетка-крацовка чашка с гайкой

CZ Čelní kartáč, ryhovaný drát
 RO Perie frontală, sármă ondulată
 H Homlok drótkefe, sodrott dróttal
 E Cepillo de copa de alambre ondulado



No.	Ø (mm)	min-1	
06970	75	12500	12/72
06971	100	8500	6/24

PL Szczotka tarczowa, drut karbowany
 GB Circular brush - crimped wire
 D Stahldraht-Kegelbürste
 RUS Щетка-крацовка с гайкой

CZ Koločový kartáč, ryhovaný drát
 RO Perie rotundă, sármă ondulată
 H Tarcssá drótkefe, sodrott dróttal
 E Cepillo redondo de alambre ondulado



No.	Ø (mm)	min-1	
06972	100	12500	12/72
06973	115	12500	12/72

PL Szczotka czolowa z gwintem, drut splatany
 GB Cup brush - twisted wire
 D Stahldraht-Zopftopfbürste
 RUS Щетка - крацовка круговая крученая щетка крацовка (чашка)

CZ Čelní kartáč, pletený drát
 RO Perie frontală, sármă împletită
 H Homlok drótkefe, sodrott dróttal
 E Cepillo de copa de alambre conico



No.	Ø (mm)	min-1	
06974	65	12500	12/36
06975	80	8500	12/36
06976	100	8500	6/24

PL Szczotka tarczowa z gwintem, drut splatany
 GB Circular brush - twisted wire
 D Stahldraht-Zopf-Kegelbürste
 RUS Щетка-крацовка усиленная

CZ Kotočový kartáč, pletený drát
 RO Perie rotativă, sârmă împletită
 H Tarcás drótkéfe, egyenes dróttal
 E Cepillo redondo de alambre conico

100
 Ømm



No.	Ø (mm)	min-1	Icon
06977	100	12500	12/48

PL Szczotka tarczowa, drut karbowany
 GB Circular brush - crimped wire
 D Stahldraht-Scheibenbürste
 RUS Щетка-крацовка латунированная сталь

CZ Kotočový kartáč
 RO Perie rotativă
 H Tarcás drótkéfe
 E Cepillo redondo de alambre ondulado



No.	Ø (mm)	min-1	Icon
06978	125	6000	12/72
06979	150	6000	12/36
06980	200	4500	12/24

PL Szczotka tarczowa, drut splatany
 GB Circular brush - twisted wire
 D Stahldraht-Zopfscheibenbürste
 RUS Дисконая щетка витая

CZ Kotočový kartáč
 RO Perie rotativă
 H Tarcás drótkéfe
 E Cepillo redondo de alambre conico



No.	Ø (mm)	min-1	Icon
06981	100	11000	12/72
06982	115	11000	12/48
06983	150	9000	12/36

PL Szczotka tarczowa z trzpieniem, drut karbowany
 GB Circular brush - crimped wire
 D Stahldraht-Scheibenbürste mit Dorn
 RUS Щетка-крацовка со стержнем
 CZ Kotočový kartáč, z hrotem, ryhovaný drát
 RO Perie rotundă cu coadă, sârmă ondulată
 H Tarcás drótkéfe, nyéllal, sodrott dróttal
 E Cepillo redondo con mandril de alambre ondulado



No.	Ø (mm)	min-1	Icon
06985	75	4500	10/120
06986	100	4500	12/120

PL Szczotka czolowa z trzpieniem, drut karbowany
 GB Cup brush - crimped wire
 D Stahldraht-Topfbürste
 RUS Щетка-крацовка со стержнем чашка
 CZ Čelní kartáč, z hrotem, ryhovaný drát
 RO Perie frontală cu coadă, sârmă ondulată
 H Homlok drótkéfe, nyéllal, sodrott dróttal
 E Cepillo de copa con mandril, de alambre ondulado



No.	Ø (mm)	min-1	Icon
06987	50	4500	10/180
06988	75	4500	12/96

PL Szczotki druciane z trzpieniem,
 drut karbowany
 GB Wire brush set
 D Stahldraht-Bürstensatz
 RUS Набор щеток-крацовок со стержнем

CZ 2 NUXAQ NUXM drátěný se stopkou
 RO Set perii sarma ondulata
 H Tarcás drótkéfe, nyéllal, sodrott dróttal
 E Cepillos de alambre con mandril

3
 PCS



No.	Ø (mm)	min-1	Icon
06989	25; 50; 50	4500	12/60

PL Szczotki druciane okragle
 GB Steel wire brush set
 D Stahldraht-Bürstensatz
 RUS Набор щеток

CZ Drátěné kartáče kulaté
 RO Perii de sârmă rotunde
 H Kerek drótkéfe
 E Cepillos de alambre redontos



No.	min-1	Icon
06990	4500	20/120

PL Szczotka czolowa z trzpieniem, drut karbowany
 GB Cup brush - crimped wire
 D Stahldraht-Topfbürste
 RUS Щетка-крацовка „КИСТЬ” со стержнем
 CZ Čelní kartáč, z hrotem, ryhovaný drát
 RO Perie frontală cu coadă, sârmă ondulată
 H Homlok drótkéfe, nyéllal, sodrott dróttal
 E Cepillo de copa con mandril, de alambre ondulado



No.	Ø (mm)	min-1	Icon
06992	24	4500	24/192

- PL Szczotka tarczowa z trzpieniem, drut splatany
 GB Circular brush - twisted wire
 D Stahldraht-Zopf Scheibenbürste mit Dorn
 RUS Щетка-крацовка витая
 CZ Kotoučový kartáč, z hrotem, pletený drát
 RO Perle rotativă cu coadă sărmă împletită
 H Tarcás drótkefe, nyéllel, egyenes dróttal
 E Cepillo redondo con mandril de alambre conlco



No.	Ø (mm)	min-1	Icon
06993	75	12500	30/180

- PL Szczotka czolowa z trzpieniem, drut splatany
 GB Cup brush - twisted wire
 D Stahldraht-Zopf runderbürste
 RUS Щетка-крацовка витая со стержнем
 CZ Čelní kartáč, z hrotem, pletený drát
 RO Perle frontală cu coadă, sărmă împletită
 H Horniok drótkefe, nyéllel, egyenes dróttal
 E Cepillo de copa con mandril de alambre conlco



No.	Ø (mm)	min-1	Icon
06994	75	12500	12/96
06995	22	4500	24/192

- PL Rotoflex przegubowy
 GB Rotoflex profi
 D Rotoflex profi
 RUS Диск резиновый д/дрели rotoflex

- CZ Kloubový rototflex
 RO Suport disc abraziv, fixare scal
 H Csuklós rototflex
 E Rotoflex articulado

125
Ømm



No.	Ø (mm)	min-1	Icon
08300	125	2000	20

- PL Przystawka z rzepem
 GB Rubber disc with velcro
 D Klett-Haftstützteller mit Dorn
 RUS Шлифовальный диск с липучкой

- CZ Přídavné zařízení ze zipem
 RO Disc-Suport cu scal pt. hârtie abrazivă rotundă
 H Kistál tapadókoronggal
 E Disco de goma con velcro

HOOK FASTENER Z RZEPEM



No.	Ø (mm)	min-1	Icon
08312	125	2000	12/120

- PL Przystawka-dysk z trzpieniem
 GB Rubber disc with arbor
 D Klett-Haftsteller + Ersatzdorn
 RUS Диск резиновый с шестигранным хвостовиком

- CZ Nástavec-kotouč s upínacím trnem
 RO Disc cu știft, ajută
 H Csizszó korong nyéllel
 E Disco de goma con mandril

125
Ømm



No.	Ø (mm)	min-1	Icon
08314	125	3250	30/120

- PL Euro dysk do kątowni z rzepem
 GB Rubber disc for angle grinder with velcro
 D Klett-Gummihaftstützteller mit Gewindeflansch
 RUS Шлифовальный диск с липучкой и гайкой

- CZ Euro disk do úhelníků ze zipem
 RO Suport disc abraziv, fixare scal
 H Euro lemez élhez, tapadókoronggal
 E Disco de goma para angul con velcro

M14



No.	Ø (mm)	min-1	Icon
08315	125	12200	30/120

- PL Przystawka do szlifierek kątowych i wiertarek
 GB Rubber disc for angle grinder and drill machine
 D Klett-Haftstützteller mit Gewindeflansch und Ersatzdorn
 RUS Шлифовальный диск с липучкой, гайкой M14 и винтом тип „Euro”
 CZ Kotouč do úhelníků ze zipem
 RO Suport disc abraziv, fixare scal
 H Euro lemez élhez, tapadókoronggal
 E Disco de goma para ancull con mandril

M14 125
Ømm



No.	Ø (mm)	min-1	Icon
08316	125	12200	30/120

- PL Tarcza do kątowni z rzepem
 GB Rubber disc for angle grinder with velcro
 D Klett-Gummihaftstützteller mit Gewindeflansch
 RUS Полировочный диск с гайкой M14 и липучкой тип „Euro”
 CZ Kotouč do úhelníků ze zipem
 RO Suport disc abraziv, fixare scal
 H Euro lemez élhez, tapadókoronggal
 E Disco para el pulidor angular con sujetador Velcro

M14 125
Ømm



No.	Ø (mm)	min-1	Icon
08318	125	12500	25/100

PL Tarcza gumowa „multi-dysk” z rzepem
 GB „MULTI-DYSK” rubber disc with velcro
 D Gummihafstüttzeller
 RUS Диск резиновый д/дрели „multi-dysk”

CZ Terč multi-dysk ze zipem
 RO Suport disc abraziv, fixare scal
 H Multidisc tárcsa tapadókorong
 E Multi-disco con velcro

125
 Ømm



PRO
 FILLO

No.	Ø (mm)	min-1	☐
08350	125	2000	20

PL Przystawka z rzepem
 GB Rubber disc with velcro
 D Klett-Haftstüttzeller mit Dorn
 RUS Диск резиновый с липучкой д/дрели

CZ Přídavné zařízení ze zipem
 RO Suport disc abraziv, fixare scal
 H Kistál tapadókoronggal
 E Disco de goma con velcro



PRO
 FILLO

No.	Ø (mm)	min-1	☐
08400	125	2000	20
08410	150	2000	20

PL Euro dysk do kątowniki z rzepem
 GB Rubber disc for angle grinder with velcro
 D Klett-Haftstüttzeller mit Gewindeflansch
 RUS Диск резиновый с липучкой д/шлифмашины

CZ Euro disk do úhelníků ze zipem
 RO Euro disc cu scal pt. polizor unghiular
 H Euro lemez élhez, tapadókoronggal
 E Disco de goma para angul con velcro



PRO
 FILLO

No.	Ø (mm)	min-1	☐
08500	125	10000	20
08510	150	8500	20

PL Przystawka-dysk na śrubę
 GB Rubber disc (screw)
 D Fiberscheiben-Stüttzeller mit Dorn
 RUS Диск резиновый с шестигранным хвостовиком

CZ Přídavné zařízení –disk pro šroubu
 RO Suport disc abraziv, fixare scal
 H Tá-lemesz csavarozott
 E Disco de goma /ornillo/

125
 Ømm



PRO
 FILLO

No.	Ø (mm)	min-1	☐
08450	125	2000	20

PL Euro dysk do kątowniki z trzpieniem
 GB Rubber disc for angle grinder
 D Klettdisk für Gummistüttzeller mit Gewindeflansch und Ersatzdorn
 RUS Круг шлифовальный с липой и винтом

CZ Euro disk do úhelníků
 RO Euro disc cu scal pt. polizor unghiular
 H Euro lemez élhez, tapadókoronggal
 E Disco de goma para ancil con mandril

125
 Ømm



PRO
 FILLO

No.	Ø (mm)	min-1	☐
08501	125	10000	20

PL Tarcza do kątowniki z rzepem nr 2
 GB Rubber disc for angle grinder with velcro
 D Klett-Gummihafstüttzeller mit Gewindeflansch
 RUS Круг шлифовальный с липой и винтом

CZ Kotouč do úhelníků ze zipem číslo 2
 RO Disc de pásă cu scal nr. 2 pt. polizor unghiular
 H Euro lemez élhez, tapadókoronggal, 2 sz.
 E Disco de goma para angul con velcro

125
 Ømm



PRO
 FILLO

No.	Ø (mm)	min-1	☐
08511	125	10000	20

PL Rzep do tarczy gumowej /przylepiec/
 GB Polishing felt disc
 D Klettdisk für Gummistüttzeller
 RUS Круг шлифовальный (фетровый) черный
 CZ =IS GR SU 2 PFKR N 10000 /suchý zip/
 RO Disc pasta de lustruit cu scal
 H Tapadókorong gumitárcsához
 E Velcro para disco de goma



VOREL

No.	Ø (mm)	☐
08520	150	100
08521	125	100

PL Filc polerski na rzep
 GB Polishing felt disc
 D Filzpollerdisc
 RUS Круг фетровый/липучка
 CZ Lešticí pískánc na zip
 RO Disc pasta de lustruit cu scal
 H Polirozó filc tapadókoronggal
 E Fietro de pulir con velcro

125
 Ømm



PRO
 FILLO

No.	Ø (mm)	min-1	☐
08522	125	10000	100

PL Nóż składany
GB Folding utility knife
D Klappmesser
RUS Нож складной

CZ Kapesní nůž
RO Briceag
H Zsebkés
E Navaja



No.	mm	
76526	61x33x0.5	12/72

PL Nóż składany sierpak
GB Lock knife
D Klappmesser
RUS Нож складной

CZ Dřevěný nůž VŠN
RO Cutit secera maner lemn
H Hajlított pengéjű kés, fanyelű
E Cuchillo falciforme de madera

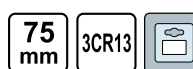

No.	blade / ostrze (mm)	
76621	75	10/100

PL Nóż składany sierpak
GB Electrician's knife
D Montagmesser
RUS Нож складной

CZ O ROMĂCI CĂ
RO Cutit pt. decablat
H Szerelőkés
E Cuchillo de montaje



No.	blade / ostrze (mm)	
76622	85	10/100

PL Nóż monterski
GB Cable knife
D Montagmesser
RUS Нож монта́рный

CZ O ROMĂCI CĂ
RO Cutit pt. decablat
H Szerelőkés
E Cuchillo de montaje



No.	type	
76640	K-506	40

PL Nóż monterski
GB Cable knife
D Montagmesser
RUS Нож монта́рный

CZ O ROMĂCI CĂ
RO Cutit pt. decablat
H Szerelőkés
E Cuchillo de montaje



No.	type	
76650	K-508	50

PL Nóż sierpak
GB Cable knife
D Klappmesser
RUS Нож садовый

CZ Dřevěný nůž VŠN
RO Cutit secera maner lemn
H Hajlított pengéjű kés, fanyelű
E Cuchillo falciforme de madera



No.	type	
76660	K-394	50

PL Nóż uniwersalny
GB Utility knife
D Universalmesser
RUS Ножи универсальны

CZ Univerzální nůž
RO Cutter metallic
H Univerzális kés
E Cutter universal



No.	blade / ostrze (mm)	
76000	61x19	25/200

PL Ostrza zapasowe do 76000
GB Spare blades for 76000
D Ersatz-Kurzklingen 5TLG. /für 76000/
RUS Запасные лезвия для ножа 76000

CZ Lomené ostří náhradní
RO Lame rezerva pt. cutter metallic
H Törhető tartalékpenge
E Filos de recambio para cutter univers.



No.	blade / ostrze (mm)	for / dla	
76010	61x19	76000	100/600

PL Noż instalacyjny z magazynkiem
 GB Cutting knife with blade compartment
 D Universalmesser
 RUS Нож обрeзинный

CZ Univerzální nůž
 RO Cutter cu maner metalic si
 compartiment pt. rezerve
 H Univerzáls kés
 E Cutter con cargador



No.	blade / ostrze (mm)	
76011	61x19	12/72

PL Nożyk z ostrzem trapezowym
 GB Utility knife
 D Universalmesser
 RUS Нож универсальный

CZ Univerzální nůž
 RO Cutter universal
 H Univerzáls kés
 E Cutter con filo trapezoidal



No.	blade / ostrze (mm)	
76015	61x19	12/72

PL Nożyk z ostrzem łamanym
 GB Metal utility knife
 D Messer mit Abbrechklingen
 RUS Нож пистолетный

CZ Univerzální nůž
 RO Cutter universal
 H Univerzáls kés
 E Cuchill con filo partido



No.	blade / ostrze (mm)	
76160	9	24/288

PL Nożyk z ostrzem łamanym
 GB Metal utility knife
 D Messer mit Abbrechklingen
 RUS Нож пистолетный

CZ Univerzální nůž
 RO Cutter universal
 H Univerzáls kés
 E Cuchill con filo partido



No.	blade / ostrze (mm)	
76180	18	40/400

PL Nożyk z ostrzem łamanym
 GB Metal utility knife
 D Messer mit Abbrechklingen
 RUS Нож пистолетный

CZ Univerzální nůž
 RO Cutter universal
 H Univerzáls kés
 E Cuchill con filo partido



No.	blade / ostrze (mm)	
76181	18	50/400

PL Nożyk z ostrzem łamanym
 GB Metal utility knife
 D Messer mit Abbrechklingen
 RUS Нож пистолетный

CZ Univerzální nůž
 RO Cutter universal
 H Univerzáls kés
 E Cuchill con filo partido



No.	blade / ostrze (mm)	
76182	18	24/240

PL Nożyk z ostrzem łamanym
 GB Metal utility knife
 D Messer mit Abbrechklingen
 RUS Нож пистолетный

CZ Univerzální nůž
 RO Cutter universal
 H Univerzáls kés
 E Cuchill con filo partido



No.	blade / ostrze (mm)	
76183	18	24/144

PL Nożyk z ostrzem łamanym
 GB Metal utility knife
 D Messer mit Abbrechklingen
 RUS Нож пистолетный
 CZ Univerzální nůž
 RO Cutter universal
 H Univerzáls kés
 E Cuchill con filo partido



No.	blade / ostrze (mm)	
76184	18	12/120

PL Nożyk z ostrzem łamanym
 GB Metal utility knife
 D Messer mit Abbrechklingen
 RUS Нож пистолетный

CZ Univerzální nůž
 RO Cutter universal
 H Univerzális kés
 E Cuchill con filo partido

18 mm



No.	blade / ostrze (mm)	
76185	18	60/600

PL Nożyk z ostrzem łamanym
 GB Metal utility knife
 D Messer mit Abbrechklingen
 RUS Нож пистолетный

CZ Univerzální nůž
 RO Cutter universal
 H Univerzális kés
 E Cuchill con filo partido

25 mm



No.	blade / ostrze (mm)	
76190	25	12/72

PL Ostrza zapasowe do nożyka
 GB Spare blades
 D Abbrechklingen
 RUS Запасные лезвия

CZ Lomené ostří náhradní
 RO Lame de rezerva pt. cutter
 H Törhető tartalékpenge
 E Filo partido de recambio

5 PCS



No.	W (mm)	pcs packing	
76214	25	5	36/288

No.	W (mm)	pcs packing	
76210	9	5	100/600
76220	18	5	100/600

PL Komplet nożyków
 GB Utility knife set
 D Universalmessersatz
 RUS Ножи пистолетные

CZ Nůž CD WISHW
 RO Set cuttere
 H Tapétaolló
 E Cuchill con filo partido

3 PCS



No.	pcs	
76230	3	50/200

PL Komplet nożyków
 GB All purpose knife set
 D Messersatz
 RUS Набор ножей и скребков

CZ Nůž CD WISHW
 RO Set cuttere
 H Tapétaolló
 E Juego de cuchillos

5 PCS



No.	pcs	
76250	5	30/150

PL Komplet nożyków
 GB All purpose knife set
 D Messersatz
 RUS Набор ножей и скребков

CZ Nůž CD WISHW
 RO Set cuttere
 H Tapétaolló
 E Juego de cuchillos

8 PCS



No.	pcs	
76280	8	25/100

PL Skrabak do szyb
 GB Window scraper
 D Glasschaber
 RUS Скребок для краски

CZ Skrabák na skla
 RO Răzuitor pt. geamuri
 H Kaparó üveghez
 E Rascador de vidrio

60 mm



No.	blade / ostrze (mm)	
06820	60	50/200

PL Nóż do szkła
 GB Glass cutter
 D Glasschneider
 RUS Стеклопоез

CZ Nůž GR VMD
 RO Diamant pt. sticlă
 H Kés üveghez
 E Cuchillo para cristal



No.		
05100		12/240

PL Nóż olejowy do szkła
GB Oil glass cutter
D Ölglasschneider
RUS Стеклорез масляный

CZ Nůž RMNVE CRVND
RO Diamant cu ulei pt. sticlă
H Olajkés üveghez
E Cuchillo de acetle para cristal



No.		
05050		6/120

PL Cyklina ręczna, drewniana
GB Double edge scraper
D Schaber
RUS Циклевка с деревянной ручкой
CZ Dřevěná hoblatka ruční
RO Rascheta dubla (maner lemn)
H Kéz, fa simító
E Rascador manual de madera



No.	mm	
06840	40	10
06860	60	10

PL Komplet nożyków precyzyjnych z ostrzami
GB Wood carving knife set
D Präzisionsmessersatz
RUS Набор для резьбы по дереву

CZ Sada přesných nůžek s bity
RO Set cutite prelucrate lemn
H Modellező készlet pengékkel
E Juego de cutters precisos con cuchillos

16
PCS



No.	pcs	
76305	16	25/100

PL Nożyczki
GB Scissors
D Haushaltsschere
RUS Ножницы

CZ Nůžn
RO Foarfece
H Olló
E Tijeras

STAINLESS
STEEL



No.	L (mm)	
76311	170	12/144
76312	220	12/144

PL Komplet nożyczek
GB Scissors set
D Haushaltsscherensatz
RUS Ножницы бытовые в наборе

CZ Univerzální nůžn
RO Foarfece universale
H Univerzális olló
E Tijeras universales

5
PCS

STAINLESS
STEEL



No.	L (mm)	pcs	
76314	140; 170; 190; 220; 250	5	12/24

PL Komplet przebijaków do skóry
GB Punch set
D Lederlöcherer
RUS Набор пробойников для кожи

CZ Sada průbojníků na kůžt
RO Set producele
H Bőrlyukasztó készlet
E Juego de perforar en piel

9
PCS



No.	Ø (mm)	
76705	2.5; 3; 4; 5; 6; 7; 8; 9; 10	10/80

PL Komplet przebijaków do skóry
GB Punch set
D Lederlöcherer
RUS Набор пробойников для кожи

CZ Sada průbojníků na kůžt
RO Set producele
H Bőrlyukasztó készlet
E Juego de perforar en piel

15
PCS



No.	Ø (mm)	
76700	2; 2.5; 3.2; 4; 4.8; 5.5; 6.4; 8; 9.5; 11.1; 12.7; 14; 15.8; 19; 22	5/20

PL Strug kątnik, czolowy
GB Rabbet plane
D Simshobel
RUS Рубанок деревянный

CZ Hoblík štíh GUÁRNYON
RO Rindea frontală unghiulară
H Párkánygyalu, homlok
E Cepillo de ranura

30
mm



No.	mm	
25830	250x30	20

PL Strug drewniany
GB Wood plane
D Putzhobel
RUS Рубанок деревянный

CZ Dřevěný hoblík
RO Rindea de lemn
H Fagyalu
E Cepillo de madera

45 mm



No.	L (mm)	type	☐
25860	45	fine / gladzik	30
25880	45	course / równiak	30

PL Zestaw pilników ślusarskich
GB Steel file set
D Werkstattfeileinsatz
RUS Напильники слесарные

CZ Zámečnické pilníky
RO Pile de lăcătuşerie
H Lakatos reszelő
E Limas de cerrajero

3 PCS
200 mm

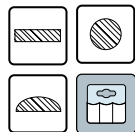

No.	L (mm)	pcs	☐
25130	200	3	12/72

PL Zestaw pilników ślusarskich
GB Steel file set
D Werkstattfeileinsatz
RUS Напильники слесарные

CZ Zámečnické pilníky
RO Pile de lăcătuşerie
H Lakatos reszelő
E Limas de cerrajero

5 PCS
200 mm

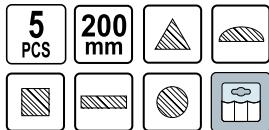

No.	L (mm)	pcs	☐
25150	200	5	25/50

PL Pilnik do metalu
GB Steel file
D Werkstattfeile
RUS Напильник слесарный

CZ Pilník na kov
RO Pila otel
H Fémreszelő
E Lima de metalo

200 mm



No.	L (mm)	☐
25160	200	20/100

PL Pilnik do metalu
GB Steel file
D Werkstattfeile
RUS Напильник слесарный

CZ Pilník na kov
RO Pila otel
H Fémreszelő
E Lima de metalo

200 mm



No.	L (mm)	☐
25161	200	20/100

PL Pilnik do metalu
GB Steel file
D Werkstattfeile
RUS Напильник слесарный

CZ Pilník na kov
RO Pila otel
H Fémreszelő
E Lima de metalo

200 mm



No.	L (mm)	☐
25162	200	20/100

PL Pilnik do metalu
GB Steel file
D Werkstattfeile
RUS Напильник слесарный

CZ Pilník na kov
RO Pila otel
H Fémreszelő
E Lima de metalo

200 mm



No.	L (mm)	☐
25163	200	20/100

PL Pilnik do metalu
GB Steel file
D Werkstattfeile
RUS Напильник слесарный

CZ Pilník na kov
RO Pila otel
H Fémreszelő
E Lima de metalo

200 mm



No.	L (mm)	☐
25164	200	20/100

PL Komplet pilników do metalu **CZ** Sada pilníků na kov
GB Steel file set **RO** Set pile otel
D Werkstattfeileinsatz **H** Fémreszelő készlet
RUS Набор напильников **E** Juego de limas para metalo

3 PCS **200** mm



VOREL

No.	L (mm)	pcs	
25165	200	3	10/20

PL Komplet pilników do metalu **CZ** Sada pilníků na kov
GB Steel file set **RO** Set pile otel
D Werkstattfeileinsatz **H** Fémreszelő készlet
RUS Набор напильников **E** Juego de limas para metalo

5 PCS **200** mm



VOREL

No.	L (mm)	pcs	
25166	200	5	10/20

PL Zestaw pilników do metalu „igłaki” **CZ** Pilníky na kov jehlové
GB Needle file set **RO** Set de pile lemn-metal
D Schlüsselfeileinsatz **H** Tűreszelő készlet fémhez
RUS Набор напильников **E** Limas de metalo agujas



No.	L (mm)	pcs	packing	
25370	4x160	5		20/200
25380	4x160	10		25/100
25390	4x160	12		25/100

PL Zestaw pilników do metalu „igłaki” **CZ** Pilníky na kov jehlové
GB Needle file set **RO** Set de pile lemn-metal
D Schlüsselfeileinsatz **H** Tűreszelő készlet fémhez
RUS Набор напильников **E** Limas de metalo agujas

6 PCS



No.	pcs	
25360	6	20/200

PL Zestaw pilników do metalu „igłaki” **CZ** Pilníky na kov jehlové
GB Needle file set **RO** Set de pile lemn-metal
D Schlüsselfeileinsatz **H** Tűreszelő készlet fémhez
RUS Набор напильников **E** Limas de metalo agujas

6 PCS



VOREL

No.	L (mm)	pcs	
25351	140	6	20/160
25352	160	6	20/160
25353	180	6	20/120

PL Tarnik do drewna **CZ** Rašple do dřeva
GB Wood rasp **RO** Pile pt. lemn
D Holzraspel **H** Fareszelő
RUS Рапибель **E** Escarpelo para madera

200 mm



VOREL

No.	L (mm)	
25170	200	20/100

PL Tarnik do drewna **CZ** Rašple do dřeva
GB Wood rasp **RO** Pile pt. lemn
D Holzraspel **H** Fareszelő
RUS Рапибель **E** Escarpelo para madera

200 mm



VOREL

No.	L (mm)	
25171	200	20/100

PL Tarnik do drewna **CZ** Rašple do dřeva
GB Wood rasp **RO** Pile pt. lemn
D Holzraspel **H** Fareszelő
RUS Рапибель **E** Escarpelo para madera

200 mm



VOREL

No.	L (mm)	
25172	200	20/100

PL Komplet tarników do drewna
GB Wood rasp set
D Holzraspelsatz
RUS Набор рашпелей

CZ Rašple do dřeva
RO Set pile pt. lemn
H Faráspoly készlet
E Juego de escarpelos para madera

3 PCS 200 mm



No.	L (mm)	pcs	box
25173	200	3	10/20

PL Komplet tarników do drewna
GB Wood rasp set
D Holzraspelsatz
RUS Набор рашпелей

CZ Rašple do dřeva
RO Set pile pt. lemn
H Faráspoly készlet
E Juego de escarpelos para madera

3 PCS 200 mm



No.	L (mm)	pcs	box
25230	200	3	15/60

PL Oselka
GB Sharpening stone
D Abziehstein
RUS Брусок

CZ Obtahovací brousek
RO Pila abraziva pt. ascuțit
H Fenőkő
E Piedra de afilar



No.	L (mm)	box
26150	150	25/50
26200	200	25/50

PL Oselka owalna
GB Sharpening stone
D Abziehstein
RUS Брусок

CZ Obtahovací brousek
RO Pila abraziva pt. ascuțit
H Fenőkő
E Piedra de afilar



No.	L (mm)	box
26210	225	50/100

PL Papier ścierny wodoodporny
GB Waterproof sand paper
D Schleifpapier wasserfest
RUS Бумага наждачная-водостойкая

CZ Smirkový papír vodní
RO Hartie abraziva rezistentă la apa
H Csiszolópapír vizes
E Papel de lija resistente al agua

50 PCS

230x280 mm



No.	type	mm	pcs	packing	box
07060	P60	230x280	50	1000	
07080	P80	230x280	50	1000	
07100	P100	230x280	50	1000	
07120	P120	230x280	50	1000	
07180	P180	230x280	50	1000	
07240	P240	230x280	50	1000	
07320	P320	230x280	50	1000	
07400	P400	230x280	50	1000	
07506	P600	230x280	50	1000	
07508	P800	230x280	50	1000	
07510	P1000	230x280	50	1000	
07512	P1200	230x280	50	1000	

PL Papier ścierny wodoodporny
GB Waterproof sand paper
D Schleifpapier wasserfest
RUS Бумага наждачная-водостойкая

CZ Smirkový papír vodní
RO Hartie abraziva rezistentă la apa
H Csiszolópapír vizes
E Papel de lija resistente al agua

15 PCS

230x280 mm



No.	mm	pcs	packing	box
07650	230x280	15	80	

PL Płótno ściernie
GB Abrasive cloth
D Schleifgewebe
RUS Шкурка шлифовальная

CZ Brusné plátno
RO Pânză abrazivă
H Csiszolóvászon
E Paño abrasivo

50 PCS

230x280 mm



No.	type	mm	pcs	packing	box
07530	P36	230x280	50	500	
07540	P46	230x280	50	500	
07560	P60	230x280	50	500	
07580	P80	230x280	50	500	
07610	P100	230x280	50	500	
07620	P120	230x280	50	500	
07630	P150	230x280	50	500	

PL Siatka ścierna
GB Abrasive mesh
D Schleifgitter
RUS Шлифовальная сетка

CZ Brusné pletivo
RO Plasă abrazivă
H Csiszolóháló
E Red abrasiva nacional

105x270 mm 



No.	type	mm	
07879	P40	105x270	50
07880	P60	105x270	50
07881	P80	105x270	50
07882	P100	105x270	50
07883	P120	105x270	50
07884	P150	105x270	50
07885	P180	105x270	50
07886	P220	105x270	50

PL Siatka ścierna
GB Abrasive mesh
D Schleifgitter
RUS Шлифовальная сетка

CZ Brusné pletivo
RO Plasă abrazivă
H Csiszolóháló
E Red abrasiva nacional

105x270 mm 





No.	type	mm	pcs. packing	
07891	P60	105x270	5	10
07894	P120	105x270	5	10

PL Siatka ścierna
GB Abrasive mesh
D Schleifgitter
RUS Шлифовальная сетка

CZ Brusné pletivo
RO Plasă abrazivă
H Csiszolóháló
E Red abrasiva nacional

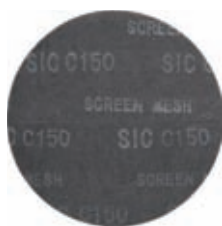
10 PCS 



No.	type	Ø (mm)	for / dla	pcs. packing	
07652	P150	225	79310 79311 79313	10	50

PL Taśma ścierna bezkońcowa
GB No end abrasive band
D Schleifband
RUS Лента абразивная

CZ Pás brusný nekonečný
RO Banda abraziva
H Végtelenített csiszolószalag
E Banda abrasiva sin extremos

5 PCS 75x533 mm 





No.	type	mm	pcs. packing	
07664	P40	75x533	5	20/60
07665	P60	75x533	5	20/60
07666	P80	75x533	5	20/60
07667	P100	75x533	5	20/60
07668	P120	75x533	5	20/60

PL Gąbka ścierna
GB Abrasive sponge
D Schleifschwamm
RUS Шлифовальная сетка

CZ Hubka brusná
RO Burete abraziv
H Dörzsszivacs
E Esponja abrasiva

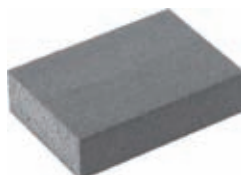



No.	type	mm	
08288	P60	24x67x97	50
08289	P80	24x67x97	50
08290	P100	24x67x97	50
08291	P120	24x67x97	50
08292	P150	24x67x97	50
08293	P180	24x67x97	50

PL Krażek ścierny
GB Abrasive disc
D Fiberschleifscheiben ungelocht
RUS Круг шлифовальный

CZ Brusný kotouč
RO Disc abraziv
H Csiszolóírácsa
E Juego de discos abrasivos

10 PCS 



No.	type	Ø (mm)	for / dla	pcs. packing	
07651	P150	225	79310 79311 79313	10	50

PL Krążek ścierny z rzepem
 GB Abrasive disc with velcro
 D Fiberschleifscheiben ungelocht
 RUS Круг шлифовальный с липучкой

CZ Brusný kotouč /zřep/
 RO Disc abraziv (scali)
 H Csiszolótárcsa /lapadókoronggal/
 E Juego de discos abrasivos /velcro/

5 PCS
 HOOK FASTENER Z RZEPEM
 125 Ømm



No.	type	Ø (mm)	pcs packing	
08553	P36	125	5	50/200
08554	P40	125	5	50/200
08556	P60	125	5	50/200
08558	P80	125	5	50/200
08560	P100	125	5	50/200
08562	P120	125	5	50/200
08565	P150	125	5	50/200

PL Krążek ścierny z otworami
 GB Abrasive disc with holes with velcro
 D Fiberschleifscheiben gelocht
 RUS Круг шлифовальный перфорированный
 CZ Brusný kotouč z otvorami
 RO Disc abraziv cu orificii
 H Csiszolótárcsa /lapadókoronggal/
 E Juego de discos abrasivos con agujeros

5 PCS
 125 Ømm
 HOOK FASTENER Z RZEPEM



No.	type	Ø (mm)	pcs packing	
08573	P36	125	5	50/200
08574	P40	125	5	50/200
08576	P60	125	5	50/200
08578	P80	125	5	50/200
08580	P100	125	5	50/200
08582	P120	125	5	50/200
08585	P150	125	5	50/200

PL Arkusze ściernie z otworami
 GB Abrasive sheets with holes
 D Schleifbogen gelocht
 RUS Шлифовальная бумага перфорированная
 CZ Brusné archy /z otvorami/
 RO Hartie abraziva cu orificii
 H Csiszolóví /lyukakkal/
 E Ojas abrasivas /con agujero/

5 PCS
 93x240 mm



No.	type	mm	pcs packing	
08533	P36	93x240	5	50/200
08534	P40	93x240	5	50/200
08536	P60	93x240	5	50/200
08538	P80	93x240	5	50/200
08540	P100	93x240	5	50/200
08542	P120	93x240	5	50/200
08545	P150	93x240	5	50/200

PL Blok ścierny gumowy
 GB Sanding block
 D Gummischleifklotz
 RUS Брусок для шлифования резиновый

CZ Brusný blok pryžový
 RO Suport smirghel
 H Csiszolóblokk, gumi
 E Bloque abrasivo de goma



No.	mm	
07920	70x125	15/60

PL Blok ścierny
 GB Sanding block
 D Handschleifer
 RUS Брусок для шлифования

CZ Brusný blok
 RO Suport smirghel
 H Csiszolóblokk
 E Bloque abrasivo



No.	mm	
07950	85x160	20/100

No.	mm	
07970	100x210	20/80

PL Blok ścierny skręcany
 GB Sanding block
 D Handschleifer
 RUS Тёрка для шлифования

CZ Brusný blok
 RO Suport smirghel
 H Csiszolóblokk
 E Bloque abrasivo



No.	mm	
07960	215x105	30

PL Blok ścierny zatrząsk
 GB Sanding block
 D Handschleifer
 RUS Тёрка для шлифования

CZ Brusný blok
 RO Suport smirghel
 H Csiszolóblokk
 E Bloque abrasivo



No.	mm	
07962	210x105	30

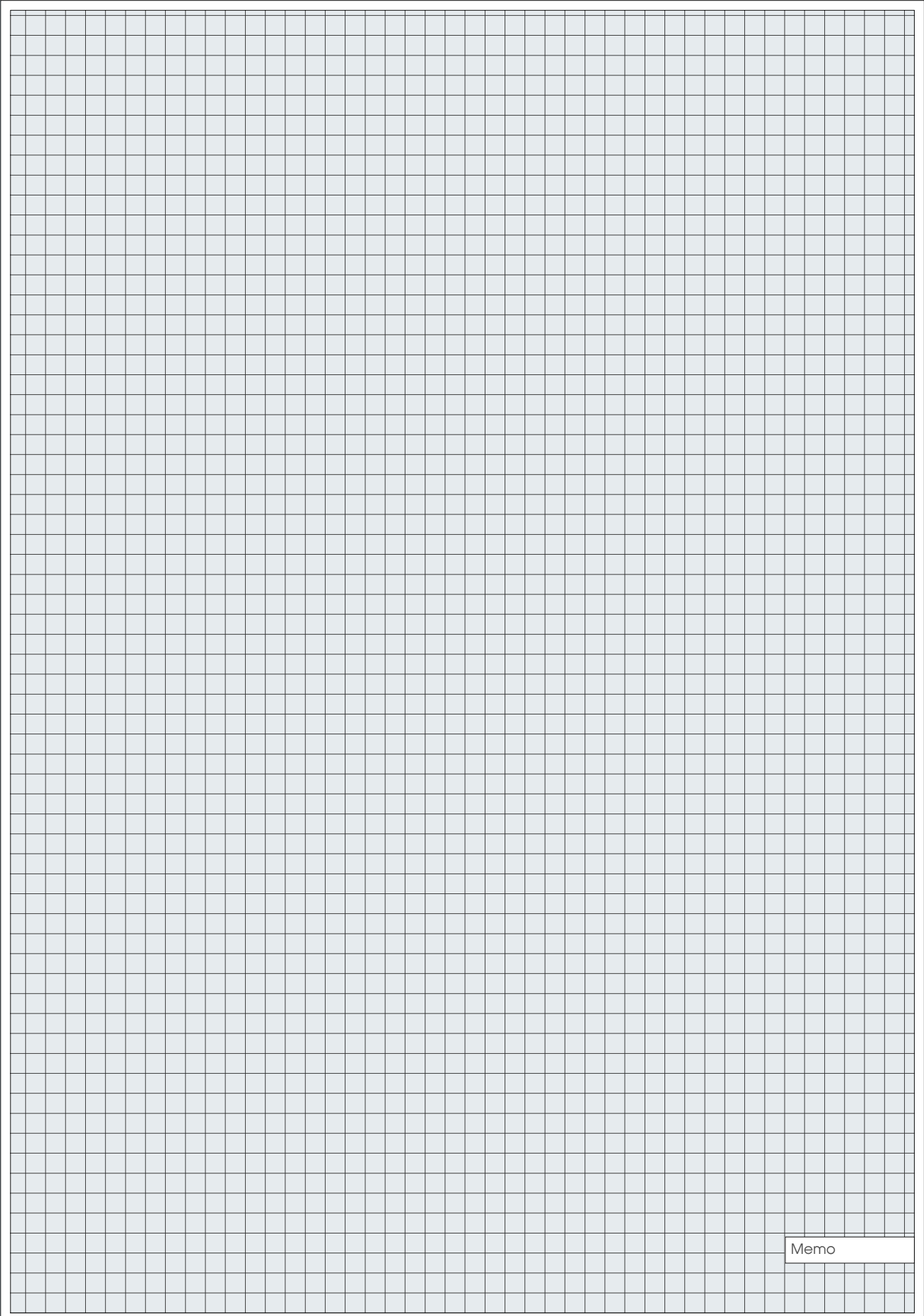

Memo

9

Hydraulic tools Narzędzia hydrauliczne

Ratchet die stocks
Komplety gwintownic ręcznych

.....106 

Hinged pipe vices
Imadła zaciskowe do rur

.....106 

Water pump pliers
Szczypce nastawne

.....106 

Pipe wrenches
Klucze do rur

.....106-107 

Pipe wrenches Stillson type
Klucze do rur typu Stillson..... 106

Adjustable pipe wrenches
Klucze do rur nastawne..... 107

Adjustable wrenches
Klucze nastawne francuskie..... 107

Chain pipe wrenches
Klucze do rur łańcuchowe

.....107 

Pipe cutters
Obcinaki do rur

.....108 

Burners & soldering tools
Palniki i lutownice

.....108 

Hydraulic accessories
Aksesoria hydrauliczne

.....109-110 

PL Zestaw narzędzi hydraulicznych
 GB Plumbing tool set
 D Hydraulischer Werkzeugkasten
 RUS Набор „Сантехник” в кейсе

CZ Soustava hydraulických nářadí
 RO Trusa instalator pt. tevi
 H Csőszereelő szerszámkészlet
 E Juego de herramientas de fontanero

13
PCS



No.	size / rozmiar	pcs	☐
55800	1/4" (6.3 mm); 3/8" (10.0 mm); 1/2" (12.5 mm); 3/4" (19.0 mm); 1" (25.0 mm); 5/4" (32.0 mm)	13	2

PL Zestaw gwintownic
 GB Ratchet die stock
 D Schneidkluppensatz
 RUS Набор резьбонарезной

CZ Sada závitníků
 RO Set de filiere
 H Menetfűrő készlet
 E Juego de roscar

8
PCS



No.	size / rozmiar	pcs	☐
55820	3/8" (10.0 mm); 1/2" (12.5 mm); 3/4" (19.0 mm); 1" (25.0 mm); 5/4" (32.0 mm)	8	4

PL Zestaw gwintownic
 GB Ratchet die stock
 D Schneidkluppensatz
 RUS Набор резьбонарезной

CZ Sada závitníků
 RO Set de filiere
 H Satu, csőszorító
 E Juego de roscar

6
PCS



No.	size / rozmiar	pcs	☐
55830	1-1/2" (38 mm); 2" (50 mm)	6	2

PL Imadło zaciskowe do rur
 GB Hinged pipe vice
 D Rohrschraubstock
 RUS Тиски для труб

CZ Upinací svérák na trubky
 RO Menghină pt. tevi
 H Satu, csőszorító
 E Tornillo de aprite para tubos



No.	mm	☐
36570	13-50	6

PL Szczypce hydrauliczne nastawne
 GB Water pump pliers
 D Wasserpumpenzange
 RUS Щипцы сантехнические

CZ Keleščič siko
 RO Cleste papagal
 H Vízpumpafagó
 E Alicates de fontanero ajustables

250
mm



No.	L (mm)	☐
41510	250	10/50

PL Klucz do rur
 GB Pipe wrench
 D Rohrschlüssel
 RUS Ключ трубный

CZ Klíč součástí na trubky
 RO Cheie reglabila pt. tevi
 H Csőkulcs
 E Llave de fontanero



No.	L (mm)	☐
55250	250	6/48
55300	300	6/36
55350	350	6/24
55450	450	4/16

PL Klucz do rur
GB Pipe wrench
D Rohrschlüssel
RUS Ключ трубный

CZ Klíč součástí na trubky
RO Cheie pt. țevi
H Csőkulcs
E Llave de fontanero



No.	L (mm)	
55620	200	6/60
55625	250	6/36
55630	300	4/24
55635	350	4/16
55645	450	3/12
55660	600	3/6
55690	900	4

PL Klucz nastawny do rur
GB Adjustable pipe wrench
D Rohrschlüssel
RUS Ключ трубный переставной

CZ Nastavitelný klíč na trubky
RO Cheie reglabilă pt. țevi
H Állítható csőkulcs
E Llave de vaso para tubería



No.	size / rozmiar	
55215	1.0" (25 mm)	24
55216	1.5" (38 mm)	16
55217	2.0" (50 mm)	8

PL Klucz nastawny francuski
GB Adjustable wrench
D Stahlschraubenschlüssel / franzose/
RUS Ключ разводной

CZ Nastavitelný klíč francuz
RO Cheie reglabilă franceză
H Állítható franciakulcs
E Llave ajustable inglesa



No.	KNF	
54499	45	10
54500	55	5
54510	65	5

PL Klucz nastawny do rur
GB Adjustable pipe wrench
D Rohrschlüssel
RUS Ключ трубный переставной

CZ Nastavitelný klíč na trubky
RO Cheie reglabilă pt. țevi
H Állítható csőkulcs
E Llave de vaso para tubería



No.	size / rozmiar	
55100	1.0" (25 mm)	12/36
55150	1.5" (38 mm)	10/20
55200	2.0" (50 mm)	6/12

PL Klucz nastawny do rur
GB Adjustable pipe wrench
D Rohrschlüssel
RUS Ключ трубный переставной

CZ Nastavitelný klíč na trubky
RO Cheie reglabilă pt. țevi
H Állítható csőkulcs
E Llave de vaso para tubería



No.	size / rozmiar	
55210	1.0" (25 mm)	24
55211	1.5" (38 mm)	16
55212	2.0" (50 mm)	8

PL Klucz nastawny do rur
GB Adjustable pipe wrench
D Rohrschlüssel
RUS Ключ трубный переставной

CZ Nastavitelný klíč na trubky
RO Cheie reglabilă pt. țevi
H Állítható csőkulcs
E Llave de vaso para tubería



No.	size / rozmiar	
55220	1.0" (25 mm)	24
55221	1.5" (38 mm)	16
55222	2.0" (50 mm)	8

PL Klucz łańcuchowy do rur
GB Chain pipe wrench
D Kettenrohrzange
RUS Ключ цепной для труб

CZ Klíč řetězový na trubky
RO Cheie reglabilă pt. țevi cu lant
H Láncos csőfogó
E Llave de cadena



No.	L (mm)	max. pipe diameter / max. średnica rury	
55792	300	4" (100 mm)	30

PL Obcinak do rur
GB Pipe cutter
D Rohrabscneider
RUS Труборіз для труб

CZ Řezač trubek
RO Clește pt. tăiat țevi
H Csővágó olló csövekhez
E Cortatubos



No.	mm	
78320	10-60	10

PL Obcinak do rur
GB Pipe cutter
D Rohrabscneider
RUS Труборіз для труб

CZ Řezač trubek
RO Clește pt. tăiat țevi
H Csővágó olló csövekhez
E Cortatubos



No.	Ø mm	
78381	1/10"-5/4" (3-32 mm)	60

PL Obcinak do rur
GB Pipe cutter
D Rohrabscneider
RUS Труборіз для труб

CZ Řezač trubek
RO Clește pt. tăiat țevi
H Csővágó olló csövekhez
E Cortatubos



No.	Ø	
78383	1/4"-1 3/4" (5-45 mm)	36

PL Gratownik do rur
GB Plastic pipe edging tool
D Aussen- und Innenratennwerkzeug
RUS Крышка для зенкования

CZ Odhrotač kombinovaný vnitřní / vnější
RO Dispozitiv pt. sanfren țevi
H Loscsőtömítő csatlakozó
E Escariador bilateral de tubos



No.	mm	
78385	6-36	25/50

PL Przecinak do rur PCV
GB PVC pipe cutter
D PVC Rohrabscneider
RUS руборез для труб из ПВХ

CZ Řezač PVC trubek
RO Clește pt. tăiat țevi din PVC
H Gázos forrasztólámpa
E Cortatubos PVC para



No.	max (mm)	
78341	42	12/48

PL Lutownica gazowa 3 w 1
GB Soldering tool 3 in 1
D Gaslötlampe 3 in 1
RUS Газовый паяльник 3-в-1

CZ Plynová pájka 3 in 1
RO Ciocan de lipit cu gaz 3 in 1
H Gaz-forrasztólámpa 3 in 1
E Soldador de gas 3 in 1

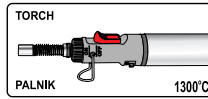

No.		
73410		12/48

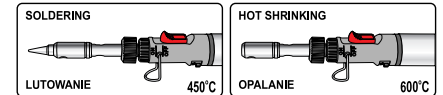

PL Gazowa lampa lutownicza
GB Gas soldering lamp
D Gaslötlampe
RUS Газовая паяльная лампа

CZ Plynová pájka lampy
RO Lampă de lipit pe gaz
H Gázos forrasztólámpa
E Lampa de gas para soldar

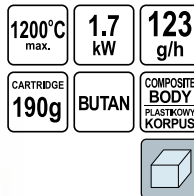

No.	kW	
73400	1.7	12

PL Gazowa lampa lutownicza PIEZO
GB Gas soldering lamp
D Gaslötlampe
RUS Газовая паяльная лампа

CZ Plynová pájka lampy
RO Lampă de lipit pe gaz
H Gázos forrasztólámpa
E Lampa de gas para soldar



No.	kW	
73403	1.7	12

PL Taśma PTFE CZ Teflonová páska
 GB PTFE tape RO Bandă de teflon
 D Teflonband H Teflon szalag
 RUS Фумлента E Cinta de teflón



No.	W (mm)	thickness / grubość (mm)	L (m)	
75200	12	0.075	10	12/2400

PL Taśma PTFE CZ Teflonová páska
 GB PTFE tape RO Bandă de teflon
 D Teflonband H Teflon szalag
 RUS Фумлента E Cinta de teflón



No.	W (mm)	thickness / grubość (mm)	L (m)	
75201	12	0.1	12	250/1000
75202	19	0.2	15	200

PL Pasta uszczelniająca do gwintów
 GB Thread sealing paste
 D Paste zum Abdichten der Gewinde
 RUS Паста-герметик для резьбы

CZ Těsnící pasta na závity
 RO Pastă etanșantă pt. filet
 H Menetítőmítő paszta
 E Pasta selladora para roscas



No.	g	
86750	65	48
86751	250	48

PL Pasta uszczelniająca do gwintów
 GB Thread sealing paste
 D Paste zum Abdichten der Gewinde
 RUS Паста-герметик для резьбы

CZ Těsnící pasta na závity
 RO Pastă etanșantă pt. filet
 H Menetítőmítő paszta
 E Pasta selladora para roscas



No.	g	
86752	360	48

PL Pakuły lniane
 GB Oakum
 D Leinenwerg
 RUS Пахла льняная

CZ Lněná koudel
 RO Călij de ln
 H Len kóc
 E Estopa de lino



No.	g	
86760	100	50

PL Hydrauliczny zestaw naprawczy
 GB Hydraulic repair kit
 D Hydraulischer Reparatursatz
 RUS Гидравлический ремкомплект

CZ Hydraulická opravárenská souprava
 RO Set de reparatii pt. instalatori
 H Vízvezeték javító készlet
 E Juego para reparaciones hidráulicas



No.	
86761	40

PL Pasta poślizgowa do rur PCV
 GB Lubricant for PVC pipes
 D Gleitpaste für PVC-Rohre
 RUS Паста-смазка для труб ПВХ

CZ Kluzná pasta na PVC trubky
 RO Pastă glisantă pt. țevi PVC
 H Sikosító paszta PVC csövekhez
 E Pasta de deslizamiento para tubos de PCV



No.	g	
86770	250	18
86771	500	15

PL Pistolet do udrażniania rur
 GB Drain cleaner
 D Pistole zum Reinigen von Rohren
 RUS Пистолет для прочистки труб
 CZ Pistole na čištění trubek
 RO Pistol pt. curățarea țevelor
 H Csőtisztító pisztoly
 E Pistola destapacanoș



No.	Ø (mm)	
55500	135	10

PL Pompa do udrażniania kanalizacji
GB Drain suction pump
D Hochdruck-Rohrreiniger
RUS Ручной насос для прочистки труб

CZ Čerpadlo na čišťení trubek
RO Pompă pt. curățarea țevilor
H Csőtisztító szivattyú
E El desague del fregadero limpiador







VOREL 

No.	Ø (mm)	
55505	65; 155	24

PL Przepychacz do udrażniania kanalizacji
GB Pipe cleaner
D Räumdorn zum Reinigen der Kanalisation
RUS Поршень для прочистки канализации

CZ Tlakový čistič kanalizace
RO Piston pt. deblocarea canalizării
H Lefolyótisztító pumpa
E Bomba destapacaños

VOREL 

No.	L (cm)	
55530	50	40

PL Przepychacz do udrażniania kanalizacji
GB Pipe cleaner
D Räumdorn zum Reinigen der Kanalisation
RUS Поршень для прочистки канализации

CZ Tlakový čistič kanalizace
RO Piston pt. deblocarea canalizării
H Lefolyótisztító pumpa
E Bomba destapacaños

2 PCS

65 cm



VOREL 

No.	L (cm)	pcs	
55531	65	2	36

PL Spirala kanalizacyjna
GB Drain auger
D Hand-Rohrreinigungsspirale
RUS Трос сантехнический пружинный

CZ Spirála kanalizační
RO Dispozitiv de desfundat scurgere
H Csőtisztító spirál
E Desatascador espiral

ZINC PLATED STEEL
STAL OCYNKOWANA



VOREL 

No.	Ø (mm)	L (m)	
55541	5	1.5	20/80
55542	6	3	18/36

PL Spirala kanalizacyjna
GB Drain auger
D Hand-Rohrreinigungsspirale
RUS Трос сантехнический пружинный

CZ Spirála kanalizační
RO Dispozitiv de desfundat scurgere
H Csőtisztító spirál
E Desatascador espiral

ZINC PLATED STEEL
STAL OCYNKOWANA



VOREL 

No.	Ø (mm)	L (m)	
55544	9	5	5/10
55545	9	10	4/8

Memo

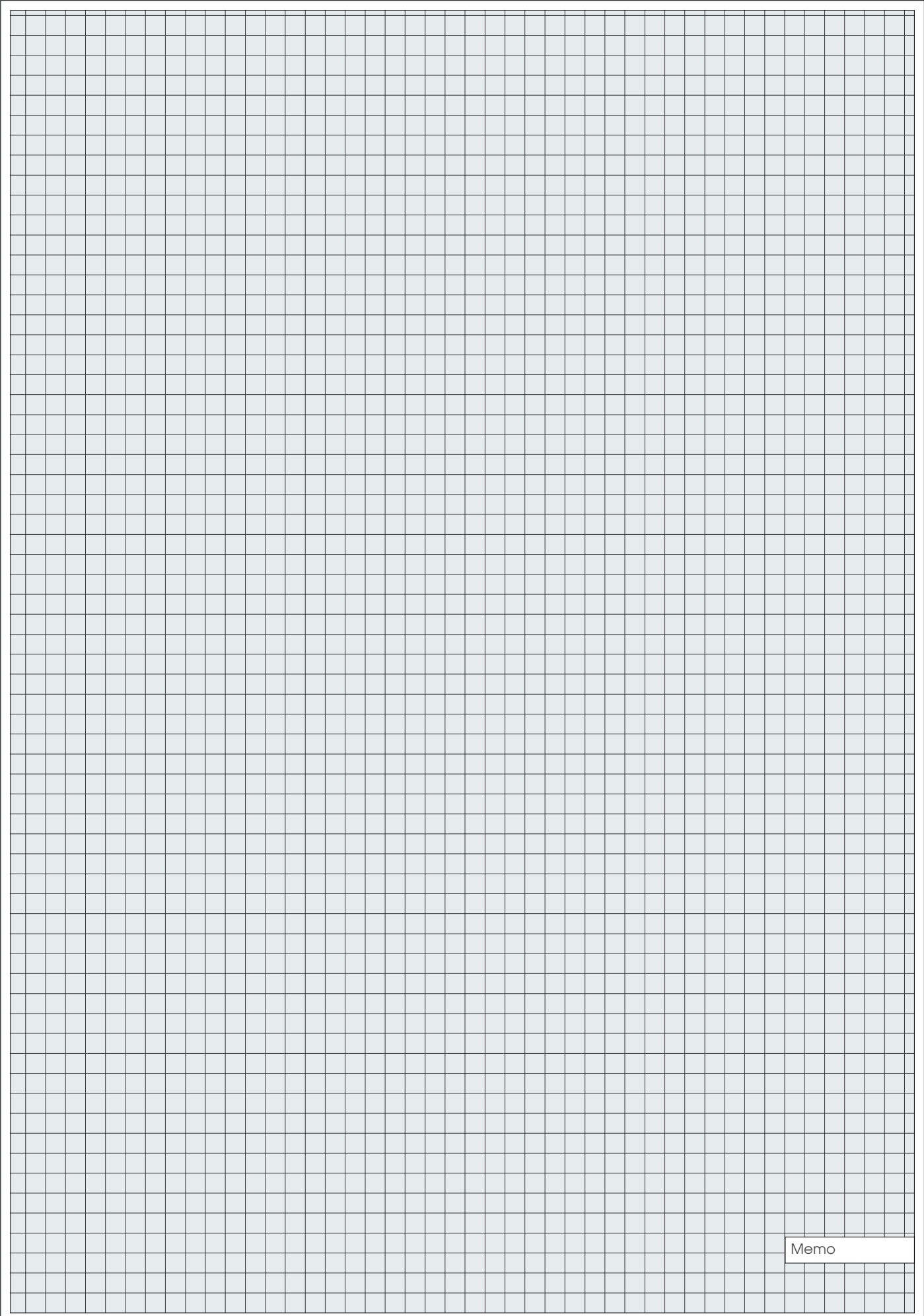

Memo

10

Fastening tools Narzędzia do łączenia

Hand riveters Nitownice ręczne		114-115
--	---	---------

Hand riveters Nitownice ręczne	114
Hand riveting tool Nitownice ręczne, dźwigniowe	115

Rivets Nity		115
-----------------------	---	-----

Aluminium blind rivets Nity aluminiowe	115
--	-----

Profile connection pliers Szczypcy do łączenia profili		115
--	---	-----

Staple guns & staples Zszywacze i zszywki		115-116
---	---	---------

Staple guns Zszywacze	115
---------------------------------	-----

Staples Zszywki	116
---------------------------	-----

Caulking guns Wyciskacze do mas		116
---	---	-----

Foam guns Pistolety do pianki montażowej		117
--	---	-----

Hose clips Opaski ślimakowe		117-118
---------------------------------------	---	---------

Cable ties Opaski plastikowe		118-119
--	---	---------

Glue sticks Wkłady klejowe		119
--------------------------------------	---	-----

Packing tape dispensers Podajniki taśmy pakowej		119
---	---	-----

Tapes Taśmy		119-121
-----------------------	---	---------

PL Nitownica ręczna
GB Hand riveter
D Blindnietzange
RUS Заклепочник

CZ Ruční nýtovačka
RO Presă de nituit manuală
H Kézi popszegecshűző
E Remachadora de mano



No.	L (mm)	Ø (mm)	Box
70000	250	2.4; 3.2; 4.0; 4.8	12/24

PL Nitownica ręczna
GB Hand riveter
D Blindnietzange
RUS Заклепочник

CZ Ruční nýtovačka
RO Presă de nituit manuală
H Kézi popszegecshűző
E Remachadora de mano



No.	L (mm)	Ø (mm)	Box
70020	240	2.4; 3.2; 4.0; 4.8	12/24

PL Nitownica ręczna
GB Hand riveter
D Blindnietzange
RUS Заклепочник

CZ Ruční nýtovačka
RO Presă de nituit manuală
H Kézi popszegecshűző
E Remachadora de mano

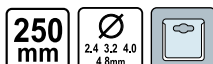

No.	L (mm)	Ø (mm)	Box
70023	250	2.4; 3.2; 4.0; 4.8	12/24

PL Nitownica ręczna
GB Hand riveter
D Blindnietzange
RUS Заклепочник

CZ Ruční nýtovačka
RO Presă de nituit manuală
H Kézi popszegecshűző
E Remachadora de mano



No.	L (mm)	Ø (mm)	Box
70030	230	2.4; 3.2; 4.0; 4.8	15/30

PL Nitownica ręczna
GB Hand riveter
D Blindnietzange
RUS Заклепочник

CZ Ruční nýtovačka
RO Presă de nituit manuală
H Kézi popszegecshűző
E Remachadora de mano

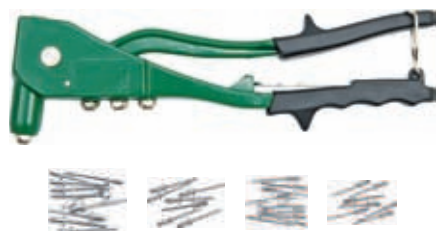
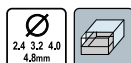

No.	L (mm)	Ø (mm)	Box
70050	250	2.4; 3.2; 4.0; 4.8	12/24

PL Nitownica ręczna
GB Hand riveter
D Blindnietzange
RUS Заклепочник

CZ Ruční nýtovačka
RO Presă de nituit manuală
H Kézi popszegecshűző
E Remachadora de mano



No.	L (mm)	Ø (mm)	Box
70100	280	2.4; 3.2; 4.0; 4.8	12/24

PL Nitownica ręczna
GB Hand riveter
D Blindnietzange
RUS Заклепочник

CZ Ruční nýtovačka
RO Presă de nituit manuală
H Kézi popszegecshűző
E Remachadora de mano



No.	L (mm)	Ø (mm)	Box
70150	250	2.4; 3.2; 4.0; 4.8	12/24

PL Nitownica ręczna
GB Hand riveter
D Blindnietzange
RUS Заклепочник

CZ Ruční nýtovačka
RO Presă de nituit manuală
H Kézi popszegecshűző
E Remachadora de mano



No.	L (mm)	Ø (mm)	Box
70160	250	2.4; 3.2; 4.0; 4.8	12/24

PL Nitownica dźwigniowa
GB Hand riveting tool
D Blindnietzange
RUS Заклепочник

CZ Nýtovačka páková
RO Pclește pt. popnitori
H Emelyűs popszegecshűzű
E Remachadora de palanca



No.	L (mm)	Ø (mm)	
70200	470	2.4; 3.2; 4.0; 4.8	10

PL Nitownica dźwigniowa
GB Hand riveting tool
D Blindnietzange
RUS Заклепочник

CZ Nýtovačka páková
RO Pclește pt. popnitori
H Emelyűs popszegecshűzű
E Remachadora de palanca

400 mm

3.4 4.0 4.8 mm



No.	L (mm)	Ø (mm)	
70210	400	3.4; 4.0; 4.8	12/24

PL Nity aluminiowe
GB Aluminium blind rivets
D Aluminiumblindnieten
RUS Алюминиевые заклепки

CZ Hliníkové nity
RO Nituri din aluminiu
H Alu popszegecs
E Remaches de aluminio

50 PCS

AI



No.	mm	pcs packing	
70320	6.4x3.2	50	25/250
70330	9.6x3.2	50	25/250
70340	12.7x3.2	50	25/250
70400	6.4x4.0	50	25/200
70410	9.6x4.0	50	25/200
70420	12.7x4.0	50	25/200
70430	19.0x4.0	50	25/200
70480	6.4x4.8	50	25/150
70490	9.6x4.8	50	25/150
70500	12.7x4.8	50	25/150
70510	19.0x4.8	50	25/150

PL Szczytce do łączenia profilu
GB Profile connection pliers
D Zange zum Verbinden der Profile
RUS Щипцы для соединения профилей

CZ Kleště ke spojování profilů
RO Clește pt. îmbinarea profilelor
H Profilyegesztű fogó
E Pinzas para conectar perfiles

280 mm

SECTION THICKNESS
GRUBSCHEITEN
PROFILU
0.5-0.8 mm

65 Mn
(PUNCH)



No.	L (mm)	
04300	280	6/36

PL Zszywacz tapicerski
GB Staple gun
D Tacker
RUS Стенпеп

CZ Čalounická sešivačka
RO Capsator tapiterie
H Kárpitos tűzőgép
E Grapadora de tapicero

4-8 mm

ABS



No.	mm	
71000	4-8	15/60

PL Zszywacz tapicerski
GB Staple gun
D Tacker
RUS Стенпеп

CZ Čalounická sešivačka
RO Capsator tapiterie
H Kárpitos tűzőgép
E Grapadora de tapicero

4-14mm



No.	mm	
71050	4-14	10/40

PL Zszywacz tapicerski
GB Staple gun
D Tacker
RUS Стенпеп

CZ Čalounická sešivačka
RO Capsator tapiterie
H Kárpitos tűzőgép
E Grapadora de tapicero

4-8 mm



No.	mm	
71040	4-8	20/40

PL Zszywacz tapicerski
GB Staple gun
D Tacker
RUS Стенлер

CZ Čalounická sešivačka
RO Capsator tapiterie
H Kárpitos tűzőgép
E Grapadora de tapicero

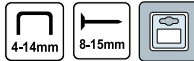

No.			
71150			6/24

PL Zszywacz tapicerski
GB Staple gun
D Tacker
RUS Стенлер

CZ Čalounická sešivačka
RO Capsator tapiterie
H Kárpitos tűzőgép
E Grapadora de tapicero



No.	mm	
71042	6-10	12/48

PL Zszywki
GB Staples
D Heftklammern
RUS Скобы

CZ Sešivky
RO Capse tapiterie
H Tűzőkapocs
E Grapas



No.	mm		pcs packing	
72040	4	0.7x11.2	1000	60/480
72060	6	0.7x11.2	1000	60/360
72080	8	0.7x11.2	1000	60/300
72100	10	0.7x11.2	1000	60/240
72120	12	0.7x11.2	1000	50/200
72140	14	0.7x11.2	1000	40/160

PL Wyciskacz do mas
GB Caulking gun
D Kartuschenpistole
RUS Пистолет для герметика

CZ Protláčovač na hmoty
RO Pistol silicon
H Masszakinymó
E Pistola para masilla



No.	mm	
09100	230	20/40

PL Wyciskacz do mas
GB Caulking gun
D Kartuschenpistole
RUS Пистолет для герметика

CZ Protláčovač na hmoty
RO Pistol silicon
H Masszakinymó
E Pistola para masilla



No.	mm	
09130	230	10/20

PL Wyciskacz do mas
GB Caulking gun
D Kartuschenpistole
RUS Пистолет для герметика

CZ Protláčovač na hmoty
RO Pistol silicon
H Masszakinymó
E Pistola para masilla



No.	mm	
09150	230	20/40

PL Wyciskacz do mas
GB Caulking gun
D Kartuschenpistole
RUS Пистолет для герметика

CZ Protláčovač na hmoty
RO Pistol silicon
H Masszakinymó
E Pistola para masilla



No.	mm	
09160	230	10/20

PL Wyciskacz do mas
GB Caulking gun
D Kartuschenpistole
RUS Пистолет для герметика

CZ Protláčovač na hmoty
RO Pistol silicon
H Masszakinymó
E Pistola para masilla



No.	
09170	10/20

PL Pistolet do pianki montażowej
 GB Foam gun
 D Farbspritz-pistole
 RUS Пистолет для нанесения полиуретановой пены

CZ 31VARI CD P RMAČ pěnu
 RO Pistol spuma
 H Felrakó pisztoly, poliurethán habhoz
 E Pistola para espuma de montaje de metalo



No.	10/20
09171	

PL Pistolet do pianki montażowej
 GB Foam gun
 D Farbspritz-pistole
 RUS Пистолет для нанесения полиуретановой пены

CZ 31VARI CD P RMAČ pěnu
 RO Pistol spuma
 H Felrakó pisztoly, poliurethán habhoz
 E Pistola para espuma de montaje de metalo



No.	10/20
09172	

PL Pistolet do pianki montażowej
 GB Foam gun
 D Farbspritz-pistole
 RUS Пистолет для нанесения полиуретановой пены

CZ 31VARI CD P RMAČ pěnu
 RO Pistol spuma
 H Felrakó pisztoly, poliurethán habhoz
 E Pistola para espuma de montaje de metalo



No.	10/20
09173	

PL Opaska ślimakowa
 GB Hose clip
 D Schlauchklemme
 RUS Хомут стальной

CZ Šneková páska
 RO Colier metallic
 H Csigapánt
 E Abrazadora



No.	Ø (mm)	↑ mm	100
73515	6-12	7.5	100
73516	8-14	7.5	100
73517	10-16	7.5	100
73521	12-20	9.0	100
73522	16-25	9.0	100
73523	20-32	9.0	100
73525	30-45	9.0	50
73527	40-60	9.0	50
73528	55-70	9.0	50
73529	65-80	9.0	50
73530	75-95	9.0	50
73532	90-110	9.0	50
73533	105-120	9.0	50
73534	115-130	9.0	50
73535	125-140	9.0	50
73536	145-160	9.0	50
73539	175-190	9.0	50
73540	190-205	9.0	50

PL Opaska ślimakowa zatraskowa
 GB Hose clip
 D Schlauchklemme
 RUS Хомут стальной

CZ Šneková páska
 RO Colier metallic
 H Csigapánt
 E Abrazadora



No.	Ø (mm)	20
73544	140	20
73545	170	20
73546	210	20

PL Opaska ślimakowa
 GB Hose clip
 D Schlauchklemme
 RUS Хомут стальной

CZ Šneková páska
 RO Colier metallic
 H Csigapánt
 E Abrazadora



No.	Ø (mm)	100
73561	8-12	100
73562	10-16	100
73563	12-22	100
73565	16-27	100
73567	20-32	100
73568	25-40	100
73569	35-50	50
73570	40-60	50
73571	50-70	50
73572	60-80	25
73573	70-90	25
73574	80-100	25
73575	90-110	25

- PL Komplet opasek ślimakowych
- GB Hose clip set
- D Schlauchklemmensatz
- RUS Набор хомутов оцинкованных
- CZ Sada šnekových pásek
- RO Set coliere metalice
- H Csigapántkészlet
- E Juego de abrazadoras

2
PCS



No.	Ø (mm)	pcs	
73836	25-40	2	40
73838	40-60	2	40

- PL Komplet opasek ślimakowych
- GB Hose clip set
- D Schlauchklemmensatz
- RUS Набор хомутов оцинкованных
- CZ Sada šnekových pásek
- RO Set coliere metalice
- H Csigapántkészlet
- E Juego de abrazadoras

4
PCS



No.	Ø (mm)	pcs	
73831	8-12	4	40
73833	12-22	4	40
73835	20-32	4	40

- PL Komplet opasek ślimakowych
- GB Hose clip set
- D Schlauchklemmensatz
- RUS Набор хомутов оцинкованных

- CZ Sada šnekových pásek
- RO Set coliere metalice
- H Csigapántkészlet
- E Juego de abrazadoras

8
PCS



No.	pcs	
73590	8	25

- PL Opaska ślimakowa
- GB Hose clip
- D Schlauchklemmen
- RUS Хомут стальной

- CZ Šneková páska
- RO Colier metalic
- H Csigapánt
- E Abrazadora



No.	Ø (mm)	
73612	6-12	100
73614	8-14	100
73616	10-16	100
73620	12-20	100
73621	14-20	100
73625	16-25	100
73627	18-27	100
73632	20-32	100
73640	25-40	100
73645	35-50	50
73660	40-60	50
73670	55-70	50
73680	65-80	50
73695	75-95	50
73700	80-100	50
73710	90-110	50
73720	105-120	50
73730	115-130	50
73740	125-140	50
73775	160-175	50
73820	205-220	50

- PL Komplet serwisowy
- GB Hose clip set
- D Schlauchklemmensatz
- RUS Набор хомутов

- CZ Dělnická sada
- RO Set coliere metalice
- H Szervizkészlet
- E Juego de juntas

365
PCS



No.	pcs	
73598	365	1

- PL Opaska ślimakowa do węży
- GB Hose clip
- D Schlauchklemme
- RUS Хомут стальной
- CZ Šneková páska
- RO Colier metalic
- H Csigapánt
- E Abrazadora



4
PCS



No.	Ø (mm)	for hose / do węży Ø	pcs	
73506	12-20	1/2" (12.5 mm)	4	20
73507	16-25	3/4" (19.0 mm)	4	20
73508	20-32	1" (25.0 mm)	4	20
73510	12-20	1/2" (12.5 mm)	4	20
	16-25	3/4" (19.0 mm)	4	20
73511	16-25	3/4" (19.0 mm)	4	20
	20-32	1" (25.0 mm)	4	20

- PL Opaski plastikowe
- GB Cable ties
- D Kabelbinder
- RUS Хомуты-стяжки пластмассовые

- CZ Plastiková páska
- RO Set coliere din plastic
- H Műanyag pánt
- E Abrazadoras de plástico



No.	mm	pcs packing	
73929	280x4.8	100	50/100

PL Opaski plastikowe
GB Cable ties
D Kabelbinder
RUS Хомуты-стяжки пластмассовые

CZ Plastiková páska
RO Set collere din plastic
H Műanyag pánt
E Abrazadoras de plástico



VOREL

No.	mm	pcs packing	
73891	75x2.4	100	250/500
73892	100x2.5	100	250/500
73893	150x2.5	100	250/500
73894	200x2.5	100	125/250
73895	300x3.6	100	75/150
73896	370x4.8	100	50/100
73897	430x4.8	100	35/70
73898	500x8.0	50	30/60

PL Opaski plastikowe
GB Cable ties
D Kabelbinder
RUS Хомуты-стяжки пластмассовые

CZ Plastiková páska
RO Set collere din plastic
H Műanyag pánt
E Abrazadoras de plástico



VOREL

No.	mm	pcs packing	
73881	75x2.4	100	250/500
73882	100x2.5	100	250/500
73883	150x2.5	100	250/500
73884	200x2.5	100	125/250
73885	300x3.6	100	75/150
73886	370x4.8	100	50/100
73887	430x4.8	100	35/70
73888	500x8.0	50	30/60

PL Opaski plastikowe
GB Cable ties
D Kabelbinder
RUS Хомуты-стяжки пластмассовые

CZ Plastiková páska
RO Set collere din plastic
H Műanyag pánt
E Abrazadoras de plástico



VOREL

No.	mm	pcs packing	
73906	200x4.8	100	75/150
73909	280x4.8	100	50/100

PL Wkłady klejowe
GB Glue sticks
D Heissklebpatronen
RUS Тубы для клеящего пистолета

CZ / HSIER YOON
RO Articole plastic (pt. pistol lipit)
H Ragasztóbetét
E Cartucho de cola



VOREL

No.	mm	kg	
73300	11x200	1	10

PL Wkłady klejowe
GB Glue sticks
D Heissklebpatronen
RUS Тубы для клеящего пистолета

CZ / HSIER YOON
RO Articole plastic (pt. pistol lipit)
H Ragasztóbetét
E Cartucho de cola



STWOR

No.	mm	pcs	
73260	7x100	12	50/200
73271	11x150	12	20/60

PL Podajnik taśmy pakowej
GB Packing tape dispenser
D Verpackungsband-Abroller
RUS Ручной диспенсер для упаковочной ленты

CZ Páskovačka
RO Pistol cu banda de impachetare
H Csomagolószalag tépő
E Precinditoare de plastic

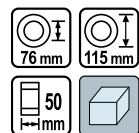

VOREL

No.	W (mm)	
75295	50	12/24

PL Taśma pakowa brązowa
GB Packing tape, brown
D Verpackungsband aus PP, braun
RUS Лента упаковочная полипропиленовая коричневая
CZ Balící páska PP hnědá
RO Bandă ambalare PP maro
H PP barna ragasztószalag
E Cinta de embalaje PP marrón



VOREL

No.	W (mm)	L (m)	
75301	48	40	72
75302	48	66	36

PL Taśma pakowa przezroczysta
GB Packing tape, transparent
D Verpackungsband aus PP, durchsichtig
RUS Лента упаковочная полипропиленовая прозрачная
CZ Balící páska PP průhledná
RO Bandă ambalare PP transparentă
H Átlátszó ragasztószalag
E Cinta de embalaje PP transparente



VOREL

No.	W (mm)	L (m)	
75303	48	40	72
75304	48	66	36

PL Taśma pakowa
GB Packing tape
D Band
RUS Скотч упаковочный прозрачный

CZ Balící páska
RO Banda scotch
H Csomagolószalag
E Cinta de embalaje



No.	W (mm)	L (m)	
75300	48	45	12/120

PL Taśma papierowa samoprzylepna
GB Self adhesive paper tape
D Papierband selbstklebend
RUS Лента малярная бумажная
CZ Páska papírová samolepící
RO Banda adeziva hartie
H Ontapadó papírszalag
E Cinta de papel adhesiva

25 m 50 m



No.	W (mm)	L (m)	
75270	19	25	12/48
75271	25	25	36
75272	30	25	10/40
75273	38	25	6/24
75274	48	25	6/24
75285	25	50	9/36
75286	30	50	10/40
75287	38	50	6/24
75288	48	50	6/24

PL Taśma dwustronna do wykładzin
GB Double-sided carpet tape
D Doppelseitiges Klebeband für Auslegware
RUS Лента двусторонняя для коврового покрытия и линолеума
CZ Obojstranná lepicí páska (na podlahové krytiny)
RO Bandă cu două părți adezivă pt. mochete
H Kétoldalas szalag szőnyegpadlókhöz
E Cinta doble cara para alfombras



No.	W (mm)	L (m)	
75260	50	5	48
75261	50	10	36
75262	50	25	24

PL Taśma dwustronna na folii
GB Double-sided tape
D Doppelseitiges Band auf PP-Folie
RUS Лента двусторонняя на базе полипропиленовой пленки
CZ Obojstranná páska na PP folii
RO Bandă cu două fețe pt. folii
H Kétoldalas
E Cinta doble cara sobre la base de PP



No.	W (mm)	L (m)	
75245	50	5	72
75246	50	10	72
75247	50	25	36

PL Taśma piankowa dwustronna
GB Double-sided mousse tape
D Schaumstoffband, beidseitig
RUS Двусторонняя пенообразная лента
CZ Pěnová páska obojstranná
RO Bandă dublu adezivă tip spuma
H Kétoldalas, habosított szalag
E Cinta de espuma de doble vista



No.	W (mm)	L (m)	
75101	19	5	90
75102	25	5	72
75103	19	10	90
75104	25	10	72

PL Taśma samoprzylepna dwustronna
GB Mounting tape
D Doppelseitiges montageband
RUS Двусторонняя монтажная лента
CZ 3I VMD P R O M A Q G R Y M W R M
RO Scotch cu banda dubla
H Kétoldalas ragasztószalag
E Cinta adhesiva, ambos lados

2 PCS 19mm x 5m 19mm x 2.25m



No.	W (mm)	L (m)	
75100	19	2.25/5	12/96

PL Taśma tekstylna „DUCT”
GB „DUCT” tape
D Textilband „DUCT”
RUS Лента текстильная „DUCT”

CZ Textilní páska „DUCT”
RO Bandă textilă „DUCT”
H „DUCT” textil szalag
E Cinta textil „DUCT”



No.	W (mm)	L (m)	
75238	48	10	36
75239	38	50	32
75240	48	50	24

PL Taśma ostrzegawcza
GB Warning tape
D Warnband, kleband
RUS Лента клейкая сигнальная
CZ / H S R I S I V N D Y E V M D Q
RO Bandă adezivă avertizare
H Figyelmeztető ragasztó szalag
E Cinta adhesiva de advertencia

PVC SELF-ADHESIVE SAMOPRZYLEPNA



No.	W (mm)	L (m)	
75231	48	33	24

PL Taśma ostrzegawcza
GB Warning tape
D Warnband, Kleband
RUS Лента клейкая сигнальная

CZ / HS/R SI WD YĚVMDAČ
RO Bandă adevizivă avertizare
H Figyelmeztető ragasztó szalag
E Cinta adhesiva de advertencia



VOREL

No.	W (mm)	L (m)	
75230	48	33	24

PL Taśma ostrzegawcza dwukolorowa
GB Two-colour warning tape
D Zweifarbiges Warnband
RUS Двухцветная предупреждающая лента

CZ 3I WD YĚVMDAČ GRIBIDUČI
RO Banda de avertizare bicolora
H Kétszínű jelzőszalag
E Cinta de advertencia bicolor



No.	W (mm)	L (m)	
75233	75	100	24

PL Taśma aluminiowa
GB Aluminium tape
D Aluminiumband
RUS Лента алюминиевая

CZ Hliníková páska
RO Bandă aluminiu
H Aluminium szalag
E Cinta de aluminiu



VOREL

No.	W (mm)	L (m)	
75140	48	10	36
75141	48	50	24

PL Taśma PCV
GB PVC Tape
D PVC Band
RUS Изолента

CZ Páska PVC
RO Banda izolatoare PVC
H PVC Szalag
E Cinta PVC



No.	W (mm)	thickness / grubość (mm)	L (m)	pcs. packing	
75000	19	0.13	10	10	50
75050	50	0.13	10	1	25/100

PL Taśma PCV
GB PVC Tape
D PVC Band
RUS Изолента

CZ Páska PVC
RO Banda izolatoare PVC
H PVC Szalag
E Cinta PVC



No.	W (mm)	thickness / grubość (mm)	L (m)	pcs. packing	
75060	19	0.13	3	6	10/100

PL Zestaw taśm izolacyjnych PCV
GB Set of PVC insulating tapes
D Satz von PVC-Isolierbändern
RUS Набор изоляционных лент ПВХ

CZ Sada izolačních pásek PVC
RO Set de benzi de izolare din PVC
H PVC szigetelő szalag készlet
E Juego de cintas aislantes PVC



No.	W (mm)	thickness / grubość (mm)	L (m)	pcs. packing	
75012	15	0.13	10	10	50
75028	19	0.13	20	10	25

PL Taśma PCV do użytku zewnętrznego
GB PVC tape
D PVC Band
RUS Лента PVC

CZ Páska PVC
RO Bandă PVC
H Kétoldalas PVC
E Cinta PVC



VOREL

No.	W (mm)	L (m)	
75030	38	33	50
75031	48	33	50

PL Taśma samowulkanizująca
GB Self-vulcanization tape
D Selbstvulkanisierendes Band
RUS Лента для самовулканизации

CZ Páska samovulkanizační
RO Banda autovulcanizanta
H Onvulkanizáló szalag
E Cinta autovulcanizadora



No.	W (mm)	thickness / grubość (mm)	L (m)	
75035	19	0.8	10	60
75036	25	0.8	5	60

11

Plastering & bricklaying tools Narzędzia budowlane i malarskie

Tile cutters & accessories
Przyrządy do cięcia glazury
i akcesoria

124-129

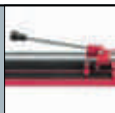
**Tile cutters**

Przyrządy do glazury..... 124

Tile cutting pliers

Szczypce do glazury..... 125

Grout removers & finishers

Skrobaki i szpachelki do fug..... 126

Accessories for tiles

Akcesoria do glazury..... 126

Burners & soldering tools
Palniki i lutownice

129

Gas burners & accessories
Palniki gazowe i akcesoria

129-131

Ladders
Drabiny

131

Masonry tools
Narzędzia budowlane

131-146

**Floats**

Pace..... 131

Trowels

Kielnie..... 133

Scrapers

Szpachelki..... 134

Painting scrapers

Skrobaki malarskie..... 136

Mason's pans

Czerpaki murarskie..... 136

Building strainers

Sita budowlane..... 136

Paint mixers & grout mixers

Mieszadła do farb i do zaprawy..... 136

Paint rollers & accessories

Wałki do malowania i akcesoria..... 138

Paint brushes

Pędzle malarskie..... 140

Painting sheets

Folie malarskie..... 142

Bags

Worki..... 142

Tapes

Taśmy..... 142

Plastic buckets & tubs

Wiadra i kasty budowlane..... 144

Suction lifters

Uchwyty do szyb..... 144

Hooks „Juco”

Haki budowlane „Juco”..... 145

Carpenter's pencils & accessories

Ołówki stolarskie i akcesoria..... 145

Benders

Giętarki..... 145

PL Przyrząd do cięcia glazury
GB Tile cutting machine
D Fliesenschneidemaschine
RUS Плиткорез

CZ Přístroj na řezání glazury
RO Aparat de taiat faianța
H Csempevágó
E Cortadora de gres

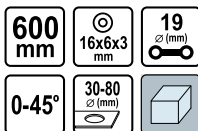

No.	mm	Ø (mm)	
00300	600	19	1

PL Przyrząd do cięcia glazury
GB Tile cutting machine
D Fliesenschneidemaschine
RUS Плиткорез

CZ Přístroj na řezání glazury
RO Aparat de taiat faianța
H Csempevágó
E Cortadora de gres

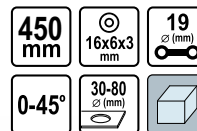

No.	mm	Ø (mm)	
00320	450	19	1

PL Przyrząd do cięcia glazury
GB Tile cutting machine
D Fliesenschneidemaschine
RUS Плиткорез

CZ Přístroj na řezání glazury
RO Aparat de taiat faianța
H Csempevágó
E Cortadora de gres

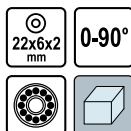

No.	mm	Ø (mm)	
00500	480	20	1
00600	580	20	1

PL Przyrząd do cięcia glazury
GB Tile cutting machine
D Fliesenschneidemaschine
RUS Плиткорез

CZ Přístroj na řezání glazury
RO Aparat de taiat faianța
H Csempevágó
E Cortadora de gres

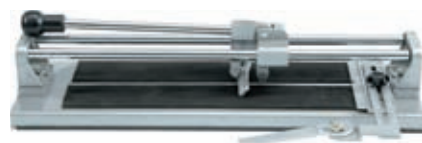
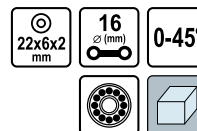

No.	mm	Ø (mm)	
00510	500	16	1
00610	590	16	1

PL Przyrząd do cięcia glazury
GB Tile cutting machine
D Fliesenschneidemaschine
RUS Плиткорез

CZ Přístroj na řezání glazury
RO Aparat de taiat faianța
H Csempevágó
E Cortadora de gres

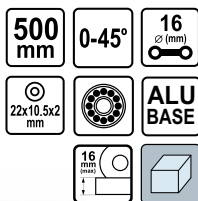

No.	mm	Ø (mm)	
00703	500	16	1

PL Przyrząd do cięcia glazury
GB Tile cutting machine
D Fliesenschneidemaschine
RUS Плиткорез

CZ Přístroj na řezání glazury
RO Aparat de taiat faianța
H Csempevágó
E Cortadora de gres

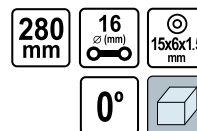

No.	mm	Ø (mm)	
02300	280	16	6

PL Przyrząd do cięcia glazury
GB Tile cutting machine
D Fliesenschneidemaschine
RUS Плиткорез

CZ Přístroj na řezání glazury
RO Aparat de taiat faianța
H Csempevágó
E Cortadora de gres

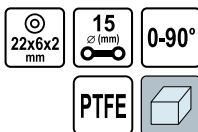

No.	mm	Ø (mm)	
01060	600	15	1

PL Przyrząd do cięcia glazury
GB Tile cutting machine
D Fliesenschneidemaschine
RUS Плиткорез

CZ Přístroj na řezání glazury
RO Aparat de taiat faianța
H Csempevágó
E Cortadora de gres

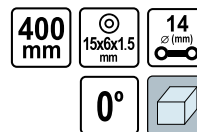

No.	mm	Ø (mm)	
02400	400	14	6

PL Kółko wymienne ze śrubą
GB Tile cutting wheel
D Schneidrad mit schraube
RUS Ролик для плиткореза

CZ Výměnné kolečko se šroubem
RO Cuiți rolă
H Cseregörgő csavarral
E Recambio de cuchillo redondo



VOREL

No.	mm	for / dla	
03150	15x6x1.5	01400; 01500; 01600; 02300; 02400	50/200
03160	16x6x3	00300; 00310; 00320	50/200
03220	22x6x2	00400; 00410; 00500; 00510; 00600; 00610; 00700; 01040; 01050; 01060	50/200

PL Kółko tnące wymienne
GB Tile cutting wheel
D Schneidrad
RUS Ролик для плиткореза

CZ Výměnné kolečko
RO Cuiți rolă
H Cseregörgő csavarral
E Recambio de cuchillo redondo



VOREL

No.	mm	for / dla	
03221	22x10.5x2	00703	50/200

PL Szczypce do glazury
GB Tile cutting pliers
D Glasurzange
RUS Кусачки для плитки

CZ Kleště do glazury
RO Clește rupt faianță
H Csempefogó
E Tenazas para azulejos

200 mm

15 mm



VOREL

No.	L (mm)	mm	
04000	200	15	10/60

PL Szczypce do cięcia i łamania glazury
GB Tile cutting pliers
D Glasurzange
RUS Кусачки для плитки

CZ Kleště do glazury
RO Clește rupt faianță
H Csempefogó
E Tenazas para azulejos

215 mm

YG-8X

13x6x1.0 mm



VOREL

No.	L (mm)	
04001	215	50

PL Szczypce do cięcia glazury
GB Tile cutting pliers
D Glasurzange
RUS Кусачки для плитки

CZ Kleště do glazury
RO Clește rupt faianță
H Csempefogó
E Tenazas para azulejos

200 mm

2x YG-8X



VOREL

No.	L (mm)	
04020	200	6/36

PL Szczypce do łamania glazury
GB Tile cutting pliers
D Glasurzange
RUS Кусачки для плитки

CZ Kleště do glazury
RO Clește rupt faianță
H Hajlított csempefogó
E Tenazas para azulejos curvo

200 mm



VOREL

No.	L (mm)	
04022	200	6/60

PL Szczypce do glazury
GB Tile cutting nipper
D Glasurzange
RUS Кусачки для плитки

CZ Kleště do glazury jednoduché
RO Clește drept pt. glazură
H Egyenes csempefogó
E Tenazas para azulejos recto

200 mm

6 mm

CUT
CIĘCIE

YG-8X



VOREL

No.	L (mm)	
04200	200	12/60

PL Obcęgi do glazury wygięte
GB Tile cutting nipper
D Glasurzange
RUS Кусачки для плитки изогнутые твердоспл.

CZ Kleště do glazury ohnuté
RO Clește curbat pt. glazură
H Hajlított csempefogó
E Tenazas para azulejos curvo

200 mm

6 mm

CUT
CIĘCIE

YG-8X



VOREL

No.	L (mm)	
04210	200	12/60

PL Młotek glazurniczy z widłową wkładką
GB Tile hammer
D Fliesenhammer
RUS Молоток для облицовочной плитки, с плоским

CZ . 03YRCD08GFH
RO Cloacan pt. placi ceramice
H Csempézókalapács
E Martillo para azulejos

12x12mm

TCT



VOREL

No.	mm	
04130	12x12	12/96

PL Młotek glazurniczy z widłowym rysikiem
GB Tile hammer
D Fliesenhammer
RUS Молоток для облицовочной плитки, с плоским

CZ . 03YRCD08GFH
RO Cloacan pt. placi ceramice
H Csempézókalapács
E Martillo para azulejos

12x12mm

TCT



VOREL

No.	mm	
04131	12x12	16/96

PL Skrobak do fug
GB Grout remover
D Fugenreiniger
RUS Скребок для фуговки

CZ Škrabák na spáry
RO Spaclu pt. rosturi
H Fugakihúzó
E Rascador para juntas



VOREL

No.		
04400		40/400

PL Skrobak do fug
GB Grout remover
D Fugenreiniger
RUS Скребок для швов кладки

CZ Škrabák na spáry
RO Răzuitoare pt. rosturi
H Fugakihúzó
E Rascador para juntas



VOREL

No.		
04406		40/160

PL Skrobak do fug
GB Grout remover
D Fugenreiniger
RUS Скребок для швов кладки

CZ Škrabák na spáry
RO Răzuitoare pt. rosturi
H Fugakihúzó
E Rascador para juntas



VOREL

No.		
04407		100

PL Szpachelka do fug
GB Grout finisher
D Fugenreiniger
RUS Скребок для швов кладки

CZ Šuves skrěpers
RO Răzuitoare pt. rosturi
H Fugakihúzó
E Rascador para juntas



VOREL

No.		
04410		450

PL Skrobak do fug
GB Grout remover
D Fugenreiniger
RUS Скребок для фуговки

CZ Škrabák na spáry
RO Spaclu pt. rosturi
H Fugakihúzó
E Rascador para juntas

TUNGSTEN CARBIDE WEGLIK WOLFRAMU



VOREL

No.	mm	
04405	50x2	12/60

PL Piłka z brzeszczolem wolframowym
GB Tile saw
D Handsäge mit Wolfram-Sägedraht
RUS Лобзик + пила с карбид-вольфрамовым напылением

CZ 3100 CD RENDG D08GFH
RO Fierăstrău pt. plac ceramică
H Fűrész csempéhez, kerámiához
E Sierra hilo carburo tungsteno

150 mm 6"

TCT



VOREL

No.	size / rozmiar	
27540	6" (150 mm)	5/60

PL Wycinarka do otworów w glazurze
GB Circular tile cutter
D Fliesenbohrzeug
RUS Резак по плитке
CZ Vyseč otvorů v glazuře
RO Cutit rotativ taiat faianta
H Lyukkivágó csempéhez
E Ruleta de corte para azulejos

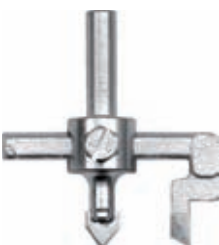

20-90
 \varnothing mm
TCT

VOREL

No.	\varnothing (mm)	
03900	20-90	80/160

PL Wycinarka do otworów w glazurze
GB Circular tile cutter
D Fliesenbohrzeug
RUS Резак по плитке
CZ Vyseč otvorů v glazuře
RO Cutit rotativ taiat faianta
H Lyukkivágó csempéhez
E Ruleta de corte para azulejos



30-80
 \varnothing mm

VOREL

No.	\varnothing (mm)	
03920	30-80	10/100

PL Wycinarka do otworów w glazurze
GB Circular tile cutter
D Fliesenlochbohrer mit handschutz
RUS Резак круговой по плитке „балеринка”

CZ Vyseč otvorů v glazuře
RO Cutit rotativ taiat faianta
H Lyukkivágó csempéhez
E Ruleta de corte para azulejos



20-94
 \varnothing mm

VOREL

No.	\varnothing (mm)	
03940	20-94	24

PL Ostrze zapasowe do wycinarki 03940
GB Spare blades for 03940
D Schneide für 03940
RUS Запасные элементы для резака 03940

CZ Náhradní soustava na vystřihováčku H03940
RO Lame rezerva pt. 03940
H Tartalekkészlet a 03940 kivágóhoz
E Juego de recambios para ruleta 03940



VOREL

No.	for / dla	
03950	03940	20/200

PL Rysik do cięcia glazury
GB Hand tile cutter and breaker
D Fliesengriffel
RUS Резак по плитке

CZ Rysovací jehla na řezání glazury
RO Cutit taiat/rupt faianta
H Karctű csempévágáshoz
E Cortador de azulejos

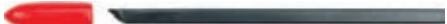

130
 mm

VOREL

No.	L (mm)	
04050	130	50/400

PL Rysik do cięcia i lamania glazury
GB TC tile cutter and breaker
D Fliesengriffel und brecher
RUS Резак по плитке с отламывателем

CZ Rysovací jehla na řezání a lámání glazury
RO Cutit taiat/rupt faianta
H Karctű csempévágáshoz és töréshez
E Cortador y rompedor de azulejos



200
 mm

VOREL

No.	L (mm)	
04100	200	50/100

PL Przyrząd do poziomowania płytek
GB Tile leveling set
D Schlagschnurgerät
RUS Уровень для укладки плитки

CZ Přístroj pro regulaci úrovně
RO Fir pl. trasat
H Padlólapszintező eszköz
E Nivelador de cuerda para azulejos

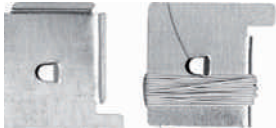

VOREL

No.		
04500		60

PL Maskownica uniwersalna
GB Magnetic lock
D Universal verdeckung mit Magnet
RUS Замок магнитный для плитки

CZ Maskovací rám univerzální do glazury
RO Opritor magnetic
H Univerzális maszkoló csempéhez
E Cierre magnético universal



VOREL

No.		
04510		40

PL Gąbka glazurnicza
GB Glazing sponge
D Fliesenschwamm
RUS Губка для кафеля

CZ Houbka na spárování obkladů
RO Burete pt. plăci ceramice
H Csempézó szivacs
E Esponja para esmaltar



No.	mm	
04540	165x100x60	74

PL Gąbka glazurnicza hydrochonna
GB Hygroscopic glazing sponge
D Wasseraufsaugender Fliesenschwamm
RUS Губка для кафеля, впитывающая влагу

CZ Houbka na spárování obkladů nasáková
RO Burete pt. plăci ceramice hidroabsorbant
H Nedvszívó csempézó szivacs
E Esponja para esmaltar higroscópica



No.	mm	
04542	170x110x60	56

PL Gąbka glazurnicza podwójna
GB Double glazing sponge
D Doppelter Fliesenschwamm
RUS Губка для кафеля, двойная

CZ Houbka na spárování obkladů dvoustranná
RO Burete pt. plăci ceramice dublu
H Dupla csempézó szivacs
E Esponja para esmaltar doble



No.	mm	
04544	165x100x80	18

PL Gąbka glazurnicza gumowa
GB Rubber glazing sponge
D Gummi-Fliesenschwamm
RUS Губка для кафеля, резиновая

CZ Houbka na spárování obkladů gumová
RO Burete pt. plăci ceramice de cauciuc
H Gumű csempézó szivacs
E Esponja para esmaltar de goma



No.	mm	
04546	150x100x50	10

PL Klíny do glazury
GB Wedges for wall and floor tiles
D Kelle für Wand und Bodenfliesen
RUS Клинья для плитки

CZ Klíny do glazury
RO Distanțiere faianță
H Ék csempéhez
E Cuñas para juntas de azulejos



No.	mm	pcs. packing	
04700	23x4	100	100
04710	37x7	50	100

PL Krzyżyki dystansowe
GB Cross shape tile spacers
D Fliesenkreuze
RUS Крестики для плитки

CZ Distanční křížky
RO Distanțiere în cruce
H Hézagoló kereszt
E Crucetas para juntas



PL Hak do usuwania krzyżyków dystansowych
GB Tile spacer remover
D Fliesenkreuzentferner
RUS Пристрій для усунення проміжків між плиткою

CZ Škrabka na čistění spár
RO Dispozitiv pt. scos distanțiere faianță
H Fuga kiséző
E Utensilio para quitar crucetas



No.		
04675		20/60



No.	mm	pcs. packing	
04600	1.5	200	100
04610	2.0	200	100
04620	2.5	200	100
04630	3.0	150	100
04640	4.0	100	100
04650	5.0	100	100
04660	6.0	75	100
04668	8.0	30	100
04670	10.0	30	100

PL Klamry do paneli ściennych
 GB Panel clamps
 D Klammern für paneele
 RUS Крепеж для панелей

CZ Přichytky do panelů
 RO Cleme (bride) pt. panouri
 H Kapcsok a panelekhez
 E Abrazaderas para paneles de paredes

100
PCS



No.	type	pcs packing	box
04720	C-3	100	50
04721	C-1	100	50

PL Lutownica gazowa 3 w 1
 GB Soldering tool 3 in 1
 D Gaslötkolben 3 in 1
 RUS Газовый паяльник 3-в-1

CZ Plynová pájka 3 in 1
 RO Ciocan de lipit cu gaz 3 in 1
 H Gaz-forrasztópaka 3 in 1
 E Soldador de gas 3 in 1

15 ml
25-80 W

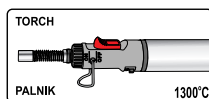

No.	box
73410	12/48

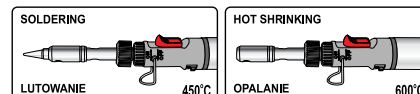

PL Gazowa lampa lutownicza
 GB Gas soldering lamp
 D Gaslötlampe
 RUS Газовая паяльная лампа

CZ Plynová pájecí lampa
 RO Lampă de lipit pe gaz
 H Gázos forrasztólámpa
 E Lampa de gas para soldar

1200°C max.
1.7 kW
123 g/h



No.	kW	box
73400	1.7	12

PL Gazowa lampa lutownicza PIEZO
 GB Gas soldering lamp
 D Gaslötlampe
 RUS Газовая паяльная лампа

CZ Plynová pájecí lampa
 RO Lampă de lipit pe gaz
 H Gázos forrasztólámpa
 E Lampa de gas para soldar

PIEZO ELECTRIC
1200°C max.
1.7 kW



No.	kW	box
73403	1.7	12

PL Zestaw do lutowania z dyszami
 GB Plumbers torch set with burners
 D Lötlatz
 RUS Набор для пайки

CZ Souprava k letování
 RO Set pt. lipit
 H Forrasztó készlet
 E Juego para soldadura

0.5 MPa (max.)
x3
17, 22, 40 mm

2m
140 g/h
2 kW

800-1200°C
BUTAN

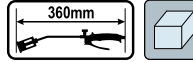

No.	MPa (max)	kW	L (mm)	box
73325	0.5	2	360	20

PL Dysza do lutowania płomień punktowy
 GB Point nozzle
 D Düse zum Löten, Punktflamme
 RUS Сопло для пайки, точечное пламя

CZ Dýza na letování, bodový plamen
 RO Duză pt. lipit, flacăară punct
 H Forrasztó égő, szűró láng
 E Tobera para soldadura, flama de punta

17
mm



No.	size / rozmiar (mm)	box
73330	17	50/250

PL Dysza do lutowania płomień płaski
 GB Flat nozzle
 D Düse zum Löten, flache Flamme
 RUS Сопло для пайки, плоское пламя

CZ Dýza na letování, plochý plamen
 RO Duză pt. lipit, flacăară plată
 H Forrasztó égő, lapos láng
 E Tobera para soldadura, flama plana

40
mm



No.	size / rozmiar (mm)	box
73331	40	50/250

- PL Dysza do lutowania płomieni otaczający
 GB Pipe nozzle
 D Düse zum Löten, Umgebungsflamme
 RUS Сопло для пайки, кольцевое пламя

- CZ Dýza na letování, prstencový plamen
 RO Duză pt. lipit, flacără înconjurătoare
 H Forrasztó égő, körülölelő láng
 E Tobera para soldadura, llama envolvente

22 mm



No.	size / rozmiar (mm)	
73332	22	50/250

- PL Palnik dekarski z dyszami
 GB Roof heating torch with burners
 D Dachdeckerbrenner
 RUS Кровельная горелка
 CZ Hořák pro pokrývače
 RO Arzător pt. acoperiș
 H Bádogos forrasztó készülék
 E Soplete de techado

1.2 MPa (max.) x3 25, 35, 50 mm 2m

360mm 2000 g/h 19.5 kW

1500-1800°C BUTAN



No.	MPa (max)	kW	L (mm)	
73340	1.2	19.5	360	10

- PL Palnik dekarski z dyszą i lancą
 GB Roof heating torch with burners
 D Dachdeckerbrenner
 RUS Кровельная горелка
 CZ Hořák pro pokrývače
 RO Arzător pt. acoperiș
 H Bádogos forrasztó készülék
 E Soplete de techado

1.2 MPa (max.) 2m x1 50mm

2000 g/h 28 kW BUTAN

745mm

1500-1800°C



No.	MPa (max)	kW	L (mm)	
73341	1.2	28	745	20

- PL Palnik dekarski z dyszą i lancą
 GB Roof heating torch with burners
 D Dachdeckerbrenner
 RUS Кровельная горелка
 CZ Hořák pro pokrývače
 RO Arzător pt. acoperiș
 H Bádogos forrasztó készülék
 E Soplete de techado

1.2 MPa (max.) 5m x1 60mm

4000 g/h 58 kW BUTAN

800-1200°C

1315mm



No.	MPa (max)	kW	L (mm)	
73342	1.2	58	1315	8

- PL Palnik dekarski z dyszami i lancą
 GB Roof heating torch with burners
 D Dachdeckerbrenner
 RUS Кровельная горелка
 CZ Hořák pro pokrývače
 RO Arzător pt. acoperiș
 H Bádogos forrasztó készülék
 E Soplete de techado

1.2 MPa (max.) 5m x2 60mm

7800 g/h 110 kW BUTAN

1385mm

1500-1800°C



No.	MPa (max)	kW	L (mm)	
73343	1.2	110	1385	8

- PL Palnik dekarski z dyszami i lancą
 GB Roof heating torch with burners
 D Dachdeckerbrenner
 RUS Кровельная горелка
 CZ Hořák pro pokrývače
 RO Arzător pt. acoperiș
 H Bádogos forrasztó készülék
 E Soplete de techado

1.2 MPa (max.) 5m x3 50mm

6900 g/h 90 kW BUTAN

1385mm

1500-1800°C



No.	MPa (max)	kW	L (mm)	
73344	1.2	90	1385	8

PL Dysza
GB Nozzle
D Düse
RUS Conno

CZ Dyza
RO Duza
H Fúvóka
E Tobera



No.	Ø (mm)	☐
73350	25	25/50
73351	35	25/50
73352	50	25/50
73353	60	25/50

PL Wąż przyłączeniowy do gazu
GB Hose
D Anschluss Schlauch für Gas
RUS Соединительный газовый шланг

CZ Hadice k připojení plynu
RO Furtun de conectare pl. gaz
H Csatlakozó gáztömlő
E Manguera de conexión de gas

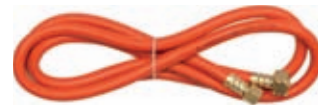

No.	L (m)	Ø (mm)	☐
73360	2	8	40
73362	5	8	20

PL Aluminiowa drabina teleskopowa
GB Aluminium telescopic ladder
D Teleskopleiter aus Aluminium
RUS Алюминиевая телескопическая лестница
CZ + ODRNÉ NĚKĚRÉ VĚBMĚSĚNÉ ŽELEŽIK
RO Scară telescopică din aluminiu
H Alumínium kihúzható létra
E Escalera telescópica de aluminio

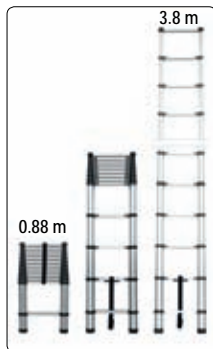

No.	☐
17700	1

PL Aluminiowa drabina teleskopowa, przegubowa
GB Articulated aluminium telescopic ladder
D Teleskop-gelenkleiter aus Aluminium
RUS Алюминиевая шарнирная телескопическая лестница
CZ + ODRNÉ NĚKĚRÉ VĚBMĚSĚNÉ ŽELEŽIK
RO Scară telescopică din aluminiu cu articulații
H Alumínium kihúzható, csuklós létra
E Escalera telescópica de aluminio articulada

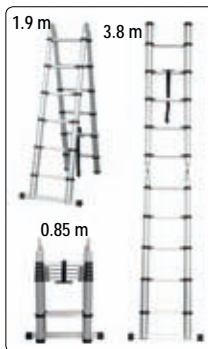

No.	☐
17703	1

PL Paca styropianowa
GB Polyurethane plastering trowel
D Styropor-reibebrett
RUS Тёрка пенопластовая

CZ Polystyrénové hladítko
RO Gletiera poliuretán
H Habszivacs simító
E Llana de polietileno



No.	mm	☐
06400	130x250	10
06410	120x500	10
06420	120x700	10
06430	120x900	10
06440	180x320	10

PL Paca styropianowa kątowa
GB Polyurethane plastering trowel
D Fummelbrett aus Kunststoff
RUS Терка пенопластовая трапеция

CZ Polystyrénové hladítko úhlové
RO Gletiera poliuretán unghiulara
H Habszivacs simító, derékszögű
E Llana de polietileno en angulo

80x340 mm



No.	mm	
06401	80x340	10

PL Tarka do styropianu
GB Steel plastering trowel
D Reibebrett für Styropor
RUS Терка стальная нержавеющая

CZ Ohnutá špachtle nerezavějící
RO Gletiera otel
H Spatula hajlított, rozsdamentes
E Espátula de acero inox curvo



No.	mm	
06470	270x130	20
06472	350x160	15

PL Paca tynkarska plastikowa
GB Plastic plastering trowel
D Glätzekelle
RUS Гладилка пластиковая

CZ Umělohmotné hladítko omítkářské
RO Gletiera PVC
H Műanyag simító vakoláshoz
E Llana de plástico para enlucido

270x130 mm



No.	mm	
06500	270x130	24

PL Paca tynkarska filc
GB Plastering trowel
D Filzgläter
RUS Терка пластмассовая с войлочным покрытием
CZ Umělohmotné hladítko omítkářské z filcem
RO Gletiera PVC cu pasla
H Műanyag simító vakoláshoz, filccel
E Llana de plástico para enlucido con fieltro

270x130 mm



No.	mm	
06510	270x130	20

PL Paca tynkarska miękka guma
GB Soft rubber plastering trowel
D Gummireibebrett
RUS Терка пластмассовая с резиновым покрытием
CZ Umělohmotné hladítko omítkářské z měkkou gumou
RO Gletiera PVC cu cauciuc
H Műanyag simító vakoláshoz, lágy gumival
E Llana de plástico para enlucido con goma suave

260x130 mm



No.	mm	
06520	260x130	30

PL Paca tynkarska gęsta gąbka
GB Plastering trowel
D Schweizer glätte
RUS Терка пластмассовая с плотным поролоновым покрытием
CZ Umělohmotné hladítko omítkářské z hustou houbou
RO Gletiera PVC cu burete dens
H Műanyag simító vakoláshoz, tömör szivaccsal
E Llana de plástico para enlucido con esponja densa

280x140 mm



No.	mm	
06530	280x140	20

PL Paca tynkarska rzadka gąbka
GB Plastering trowel
D Schwambrett
RUS Терка пластмассовая с поролоновым покрытием
CZ Umělohmotné hladítko omítkářské z řídkou houbou
RO Gletiera PVC cu burete rar
H Műanyag simító vakoláshoz, lágy szivaccsal
E Llana de plástico para enlucido con esponja poco densa

280x140 mm

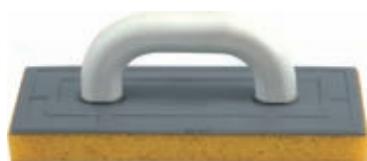

No.	mm	
06540	280x140	20

PL Paca tynkarska metalowa nierdzewna
GB Stainless steel plastering trowel
D Schweizer glätte
RUS Гладилка нержавеющей гладкая
CZ Hladítko omítkářské nerezavějící
RO Gletiera inox
H Rozsdamentes simító vakoláshoz
E Llana para enlucido acero inox.llano



No.	mm	
06640	380x125	10
06660	480x125	10
06680	600x125	18

PL Paca tynkarska metalowa nierdzewna
 GB Stainless steel plastering trowel
 D Schweizer glatte gezahnt
 RUS Гладилка металлическая зубчатая
 CZ Hladitko omltkáfské nerezavějící
 RO Gletiera inox
 H Rozsdamentes simító vakoláshoz
 E Llana para enlucido acero inox.llano



VOREL

No.	mm	teeth / zęby (mm)	
06650	380x125	8x8	10
06670	480x125	8x8	10
06690	600x125	8x8	18

PL Paca tynkarska metalowa nierdzewna
 GB Stainless steel plastering trowel
 D Glatekelle
 RUS Гладилка штукатур. нерж. гладкая

CZ Hladitko omltkáfské nerezavějící
 RO Gletiera inox maner plastic
 H Rozsdamentes simító vakoláshoz
 E Llana para enlucido acero inox.llano



VOREL

No.	mm	
06700	270x125	24

PL Paca tynkarska metalowa nierdzewna, podstawa aluminium
 GB Stainless steel plastering trowel
 D Glatekelle
 RUS Гладилка мет. гладкая

CZ Hladitko omltkáfské nerezavějící
 RO Gletiera inox
 H Rozsdamentes simító vakoláshoz
 E Llana para enlucido acero inox.llano



VOREL

No.	mm	
06701	270x130	24

PL Paca tynkarska metalowa nierdzewna
 GB Stainless steel plastering trowel
 D Glatekelle gezahnt
 RUS Гладилка нерж. зубчатая

CZ Hladitko omltkáfské nerezavějící
 RO Gletiera inox
 H Rozsdamentes simító vakoláshoz
 E Llana para enlucido acero inox.llano



VOREL

No.	mm	teeth / zęby (mm)	
06740	270x125	4x4	24
06760	270x125	6x6	24
06780	270x125	8x8	24
06781	270x125	10x10	24

PL Paca miękka z gumą do fugowania
 GB Float with soft rubber
 D Weiches Reibebrett mit Gummi zum Verfugen
 RUS Мягкая терка с резиной для расшивания

CZ Hladitko měkké s gumou na spárování
 RO Pac moale cu cauciac pt. cimentare
 H Fugázó simító puha gumival
 E Llana suave con goma para rejuntar



VOREL

No.	mm	
06512	241x75	12

PL Paca plastikowa z gąbką nacinaną
 GB Plastic float with incised sponge
 D Reibebrett aus Kunststoff, mit aufgeschnittenem Schwamm
 RUS Пластиковый шпатель с надрезной губкой
 CZ Plastové hladitko s narezanou houbou
 RO Netezitoare din plastic cu burete tăiat
 H Műanyag simító, szivaccsal
 E Llana de plástico con esponja entallada



VOREL

No.	L (mm)	sponge thickness / grubość gąbki (mm)	
06532	270x130	30	20

PL Paca plastikowa z hydrogumą
 GB Plastic float with hydronrubber
 D Reibebrett aus Kunststoff, mit Hydrogummi
 RUS Пластиковый шпатель с гидрорезиной

CZ Plastové hladitko s pěnovou gumou
 RO Netezitoare din plastic cu hidrocauciu
 H Műanyag simító, durva szivaccsal
 E Llana de plástico con hidrocaucho



VOREL

No.	L (mm)	rubber thickness / grubość gumy (mm)	
06537	270x130	9	20
06538	270x130	18	20

PL Kiełnia trójkątna
 GB Brick trowel
 D Spitzkelle
 RUS Кельма треугольная

CZ =HOCEN QFH WAKKQINRM
 RO Mistrle triunghiulară
 H Háromszög vakolókanál
 E Paleta triangular



VOREL

No.	mm	
06340	180	50
06350	200	50
06360	220	50

PL Kielnia trójkątna nierdzewna
GB Stainless steel brick trowel
D Spitzkelle
RUS Кельма треугольная нерж.

CZ =HCOFN @FHVMKHMNM CHH Dvějici
RO Mistrle triunghiulară inoxidabilă
H Háromszög vakolókanál, rozsdamentes
E Paleta triangular de acero inox.



No.	mm	
06341	180	50
06351	200	30

PL Kielnia trapezowa nierdzewna
GB Stainless steel brick trowel
D Stukkaturkelle
RUS Кельма трапецевидная нержав.

CZ Lichobá@NM JHCOFN @FHCHH Dvějici
RO Mistrle trapezoidală inoxidabilă
H Trapéz vakolókanál, rozsdamentes
E Paleta trapezoidal de acero inox.



No.	mm	
06370	130	50
06380	180	30

PL Kielnia szkatorkowa, podkowa
GB Stainless steel scraper
D Malerspachtel
RUS Кельма шпательная

CZ Ohnutá špachtle nerezavějici
RO Șpaclu indoit inoxidabil
H Spatula hajlított, rozsdamentes
E Espatula de acero inox curvo



No.	mm	
06110	60x100	50
06120	80x120	50

PL Szpachelka
GB Scraper
D Malerspachtel
RUS Шпатель

CZ Špachtle
RO Șpaclu
H Spatula
E Espatula



No.	mm	
06030	30	12/240
06040	40	12/240
06050	50	12/240
06060	60	12/240
06080	80	12/240
06100	100	12/240

PL Komplet szpachelek
GB Scraper set
D Kelle für Innenecken
RUS Набор шпателей

CZ Špachtle
RO Șpacluri
H Spatula
E Espatulas

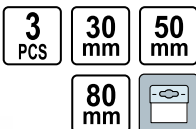

No.	mm	pcs	
06130	30; 50; 80	3	25/100

PL Szpachelka kątowa zewnętrzna
GB Stainless steel scraper
D Kelle für Aussenecken
RUS Кельма для наружных углов

CZ Úhlová špachtle vnější
RO Șpaclu unghiular exterior
H Kúlsőél kanál
E Paleta en angulo



No.	mm	
06140	80x60x60	50

PL Szpachelka kątowa wewnętrzna
GB Stainless steel scraper
D Kelle für Innenecken
RUS Кельма для внутренних углов

CZ Úhlová špachtle vnitřní
RO Șpaclu unghiular interior
H Belsőél kanál
E Paleta en angulo



No.	mm	
06150	80x60x60	50

PL Szpachelki „japonki” nierdzewne
GB Stainless steel scraper set
D Aufstreichspachtel
RUS Набор шпателей тип „японский” нерж.
CZ Špachtle japonsky nerezavějici
RO Șpaclu japonez inox set
H Spatula rozsdamentes
E Espatulas „japonesas” de acero inox

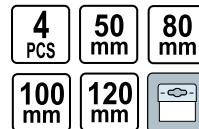

No.	mm	pcs	
06290	50; 80; 100; 120	4	12/120

PL Szpachla malarska nierdzewna
 GB Stainless steel putty knife
 D Glasurzange
 RUS Шпатель фасадный гладкий нержав

CZ Malířská špachtle nerezavějící
 RO Spaciu de chituit, inox, maner plastic
 H Rozsdamentes festőspatula
 E Espatula de pintura, de acero inox



No.	mm	
06294	40	100
06295	60	80
06296	80	60
06297	100	50
06298	150	80
06301	200	60
06304	250	50
06307	350	25
06308	450	25
06309	600	10

PL Szpachla nierdzewna
 GB Stainless steel putty knife
 D Kleberspachtel
 RUS Шпатель фасадный зубчатый нержав.

CZ Špachtle nerezavějící
 RO Spaciu de chituit, inox, maner plastic, crestat
 H Rozsdamentes spatula
 E Espatula de acero inox.



No.	mm	teeth / zęby (mm)	
06299	150	6x6	80
06300	150	8x8	80
06302	200	6x6	60
06303	200	8x8	60
06305	250	6x6	50
06306	250	8x8	50

PL Szpachla gumowa do fugowania
 GB Rubber grout spreader
 D Gummispachtel
 RUS Шпатель резиновый для фуговки

CZ Špachtle z gumy
 RO Spaciu caulcucat pt. rosturi
 H Fugázógumi
 E Espatula de goma para rejuntar



No.	mm	
06310	150	30
06320	200	30
06330	250	30
06331	300	30

PL Szpachelka nierdzewna
 GB Stainless steel scraper
 D Rostfrei Spachtel
 RUS Шпатель нержавеющей

CZ Špachtle
 RO Șpacu
 H Spatula
 E Espatula de acero inox



No.	mm	
05901	30	6/72
05902	40	6/72
05903	50	6/72
05904	60	6/72
05905	80	6/72
05906	100	6/72

PL Szpachelka nierdzewna
 GB Stainless steel scraper
 D Rostfrei Spachtel
 RUS Шпатель нержавеющей

CZ Špachtle
 RO Șpacu
 H Spatula
 E Espatula de acero inox



No.	mm	
05911	30	6/72
05912	40	6/72
05913	50	6/72
05914	60	6/72
05915	80	6/72
05916	100	6/72

PL Szpachelka nierdzewna wygięta
 GB Stainless steel scraper
 D Rostfrei Spachtel
 RUS Шпатель нержавеющей изогнутый

CZ Špachtle
 RO Șpacu
 H Spatula
 E Espatula de acero inox curvo



No.	mm	
05921	30	6/72
05922	40	6/72
05923	50	6/72
05924	60	6/72
05925	80	6/72
05926	100	6/72

PL Skrobak malarski
GB Painting scraper
D Malerabkratzer
RUS Скребок со сменным лезвием



100 mm



No.	blade / ostrze L (mm)	
06795	100	60

PL Skrobak malarski
GB Painting scraper
D Malerabkratzer
RUS Скребок со сменным лезвием



No.	W (mm)	
06797	115	50

PL Ostrze do skrobaka 06795
GB Spare blades for 06795
D Schneide für 06795
RUS Запасные элементы для 06795



5 PCS

100 mm



No.	for / dla	pcs packing	
06796	06795	5	10/100

PL Czerpak murarski
GB Mason's pan
D Gipspfänchen
RUS Черпак малярный



No.		
06335		50

PL Sito budowlane
GB Building strainer
D Bau Sieb
RUS Сито строительное
CZ Prohazovací síto stavební
RO Sită construcții
H Építőipari rosta
E Cedazo para construcción



No.	cm	size of eyelet / rozmiar oczka (mm)	
34944	60x100	4	30
34945	60x100	6	30
34946	60x100	8	30
34947	60x100	10	30

PL Mieszadło do farb
GB Paint mixer
D Farbmischer
RUS Мешалка д/краски



No.	mm	
09060	60x400	40/80
09080	85x400	40/80
09090	100x600	30

PL Mieszadło do zapraw i klejów
GB Mixer for compound and glue
D Wendelrührer
RUS Мешалка для растворов и клея



No.	mm	
09005	65x410	40
09006	80x410	40

PL Mieszadło do zapraw i klejów
 GB Mixer for compound and glue
 D Wenderührer
 RUS Мешалка для растворов и клея

CZ Michadlo na malty a lepidla
 RO Agitator pt. mortar și cleuri
 H Habarcs és ragasztó keverő
 E Mezcladora para morteros y pegamentos



VOREL

No.	mm	
09010	110x510	40

PL Mieszadło do gipsu i gładzi
 GB Mixer for gypsum and coat
 D Gips- und wachsrührer
 RUS Мешалка для гипса и затирок

CZ Michadlo na sádku a stěrku
 RO Agitator pt. ipsos și honuturi
 H Gipsz és glett keverő
 E Mezcladora para yeso



VOREL

No.	mm	
09015	85x400	40
09017	100x500	40

PL Mieszadło do gipsu i gładzi
 GB Mixer for gypsum and coat
 D Gips- und wachsrührer
 RUS Мешалка для гипса и затирок

CZ Michadlo na sádku a stěrku
 RO Agitator pt. ipsos și honuturi
 H Gipsz és glett keverő
 E Mezcladora para yeso



No.	mm	type	
09025	75x370	C-75	20

PL Mieszadło do mas
 GB Mixer for compound
 D Rührer für Materialien auf bitumenbasis
 RUS Мешалка для строительных масс

CZ Michadlo na stavební hmoty
 RO Agitator pt. mase
 H Keverő masszához
 E Mezcladora para masas



No.	mm	
09044	80x400	25
09046	100x600	25

PL Mieszadło do mas
 GB Mixer for compound
 D Rührer für Materialien auf bitumenbasis
 RUS Мешалка для строительных масс

CZ Michadlo na stavební hmoty
 RO Agitator pt. mase
 H Keverő masszához
 E Mezcladora para masas



No.	mm	type	
09048	75x400	C-75	20
09049	85x450	C-85	20
09050	100x500	C-100	20
09051	110x550	C-110	20

PL Mieszadło do mas
 GB Mixer for compound
 D Rührer für Materialien auf bitumenbasis
 RUS Мешалка для строительных масс

CZ Michadlo na stavební hmoty
 RO Agitator pt. mase
 H Keverő masszához
 E Mezcladora para masas



No.	mm	
09054	80x400	25
09056	100x600	25

PL Mieszadło do materiałów sypkich
 GB Mixer for loose materials
 D Mischer
 RUS Мешалка для сыпучих веществ

CZ Michadlo na sypké materiály
 RO Agitator pt. materiale vărsătoare
 H Keverő szóródó anyagokhoz
 E Mezcladora para materiales sueltos



No.	mm	
09028	80x400	35

PL Mieszadło do mas
 GB Mixer for compound
 D Mörtel Mischer
 RUS Мешалка для строительных масс

CZ Michadlo na stavební hmoty
 RO Agitator pt. mase
 H Keverő masszához
 E Mezcladora para masas



No.	mm	
09036	60x400	60
09038	80x400	35
09040	100x600	30

PL Mieszadło
GB Mixer
D Rondenrührer
RUS Мешалка

CZ Michadlo
RO Mixer
H Keverő
E Mezcladora



No.	mm	type	
09094	120x600	C-120	10

PL Mieszadło turbo z gwintem
GB Turbo threaded stirrer
D Turbomischer mit Gewinde
RUS Турбо мешалка с резьбой

CZ Michadlo turbo se závitem
RO Dispozitiv de amestecat turbo cu filet
H Menetes, turbó keverő
E Turbo mezcladora con rosca



No.	mm	type	
09063	115x580	M14	10
09065	135x580	M14	10

PL Walek do odpowietrzania
GB Deaeration roller
D Entlüftungsrolle
RUS Валик азрационный

CZ Váleček na odvzdušňování
RO Rola pt. modelare sapa
H Levegőkinyomó henger
E Rodillo para hacer el vacío



No.	mm	
06450	75x230	15
06452	110x230	10

PL Walek do odpowietrzania
GB Deaeration roller
D Entlüftungsrolle
RUS Валик азрационный

CZ Váleček na odvzdušňování
RO Rola pt. modelare sapa
H Levegőkinyomó henger
E Rodillo para hacer el vacío



No.	mm	
06453	110x500	6

PL Walek malarski Syntex
GB Paint roller Syntex
D Malerroller Syntex
RUS Валик в сборе полиакрил

CZ Malířský váleček
RO Trafalet Syntex
H Festőhenger
E Rodillii de pintura



No.	W (mm)	handle / uchwył Ø (mm)	
09307	180	6	55
09308	250	6	50

PL Walek malarski Girpaint
GB Paint roller Girpaint
D Malerroller Girpaint
RUS Валик в сборе полиамид

CZ Malířský váleček Girpaint
RO Trafalet cu fir galben
H Festőhenger Girpaint
E Rodillii de pintura Girpaint



No.	W (mm)	handle / uchwył Ø (mm)	
09334	100	6	40
09336	180	6	60

PL Walek malarski Vestan
GB Paint roller Vestan
D Malerroller
RUS Валик в сборе полиамид

CZ Malířský váleček
RO Trafalet lana artificiala
H Festőhenger
E Rodillii de pintura



No.	W (mm)	handle / uchwył Ø (mm)	
09345	180	6	55
09346	250	6	50

PL Walek malarski Flok
GB Paint roller Flok
D Malerroller Flok
RUS Валик в сборе полиакрил

CZ Malířský váleček
RO Trafalet burete fin
H Festőhenger
E Rodillii de pintura



No.	W (mm)	handle / uchwył Ø (mm)	
09359	50x150	6	50

PL Walek malarski Moltopren
 GB Paint roller Moltopren
 D Malerroller Moltopren
 RUS Валик в сборе поролон

CZ Malířský váleček
 RO Trafalet Burete cu tija plastic
 H Festöhenger
 E Rodill de pintura



No.	mm	handle / uchwył (mm)	
09370	35x50	6	70

PL Walek malarski Moltopren
 GB Paint roller Moltopren
 D Malerroller Moltopren
 RUS Валик в сборе поролон

CZ Malířský váleček
 RO Trafalet Burete cu tija plastic
 H Festöhenger
 E Rodill de pintura



No.	mm	handle / uchwył (mm)	
09371	35x70	6	80
09372	35x100	6	70
09373	50x150	6	50

PL Zapas do walka Multicolor
 GB Paint roller refill Multicolor
 D Maler-Ersatzwalzen Multicolor
 RUS Шубка полиамидовая для валика

CZ Náhradní váleček Multicolor
 RO Rezerva trafalet fir Multicolor
 H Csere festöhenger Multicolor
 E Lana de polietileno Multicolor

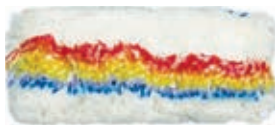

No.	W (mm)	handle / uchwył (mm)	
09302	180	6	40
09303	250	8	25

PL Zapas do walka Syntex
 GB Paint roller refill Syntex
 D Maler-Ersatzwalzen Syntex
 RUS Шубка полиакриловая для валика

CZ Náhradní váleček Syntex
 RO Rezerva Trafalet Acril Verde
 H Csere Syntex hengerhez
 E Repuesto para el cilindro Syntex



No.	W (mm)	handle / uchwył (mm)	
09310	180	6	10/40
09311	250	6	40

PL Zapas do walka
 GB Paint roller refill
 D Maler-Ersatzwalzen
 RUS Валик полиамид

CZ Náhradní váleček
 RO Rezerva trafalet acril rosu
 H Csere festöhenger
 E Repuesto para el cilindro

NYLON



No.	W (mm)	handle / uchwył (mm)	
09331	180	6	10/50
09332	250	8	10/40

PL Zapas do walka Girpaint
 GB Paint roller refill Girpaint
 D Maler-Ersatzwalzen Girpaint
 RUS Валик полиамид

CZ Náhradní váleček Girpaint
 RO Rezerva trafalet fir galben
 H Csere festöhenger Girpaint
 E Repuesto para el cilindro Girpaint



No.	W (mm)	handle / uchwył (mm)	pcs packing	
09338	100	6	2	150

PL Zapas do walka Flok
 GB Paint roller refill Flok
 D Maler-Ersatzwalzen Flok
 RUS Шубка флокированный мольтопрен

CZ Náhradní váleček Flok
 RO Rezerve trafalet burete fin
 H Csere festöhenger Flok
 E Esponja de recambio



No.	W (mm)	handle / uchwył (mm)	pcs packing	
09363	35x50	6	2	75
09365	35x100	6	2	80

PL Zapas do walka Moltopren
 GB Paint roller refill Moltopren
 D Maler-Ersatzwalzen Moltopren
 RUS Шубка поролоновая

CZ Náhradní váleček Moltopren
 RO Rezerve trafalet burete
 H Csere festöhenger Moltopren
 E Esponja de recambio

2 PCS



No.	mm	handle / uchwył (mm)	pcs packing	
09375	35x50	6	2	200
09377	35x100	6	2	90
09378	50x150	6	2	45

PL Kuweta malarska
GB Painting bowl
D Malerschale
RUS Ванночка малярная

CZ Malířská kyveta
RO Tava-suport trafalet
H Kúvetta
E Cuveta



No.	mm	
09406	150x245	150
09408	330x350	60

PL Walek malarski Vestan z kratką
GB Paint roller set Vestan
D Malerroller Vestan mit Abtropfgitter
RUS Валик меховой в сборе с решёткой

CZ Malířský váleček + Mřížka
RO Trafalet cu gratar
H Festöhenger + rács
E Rodilla de pintura + rejilla



No.	W (mm)	handle / uchwyt Ø (mm)	
09385	180	6	25

PL Walek malarski Vestan z kuwetą
GB Paint roller set Vestan
D Malerroller Vestan mit Malerschale
RUS Валик в сборе полиакрил

CZ Malířský váleček
RO Trafalet cu tava
H Festöhenger + kúvetta
E Rodillo de pelo + cuveta



No.	W (mm)	handle / uchwyt Ø (mm)	
09390	180	6	12

PL Walek malarski Moltopren z kuwetą
GB Paint roller set Moltopren
D Malerroller Moltopren mit Malerschale
RUS Валик поролоновый в сборе с ванночкой

CZ Malířský váleček + kyveta
RO Trafalet cu tava
H Festöhenger + kúvetta
E Rodillo esponja + cuveta



No.	W (mm)	handle / uchwyt Ø (mm)	
09395	50	6	60

PL Uchwyt do walika
GB Paint roller handle
D Malerroller-Griff
RUS Ручка для валика
CZ Uchytí Nýl Ø6ku
RO Maner trafalet
H Festöhenger nyél
E Mango del cilindro



No.	W (mm)	handle / uchwyt Ø (mm)	
09421	50/70	6	90
09422	100	6	90
09425	150	6	150
09427	180	6	110
09429	250	6	110
09430	250	8	80

PL Podpórki malarskie
GB Painting pyramids
D Malerstützen
RUS Малярные подпорки

CZ Podpěry pro lakování
RO Suporturi pt. vopsit
H Festő támasztékok
E Soportes para pintar

6 pcs
60mm
60mm

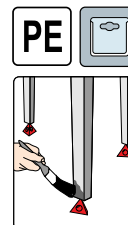
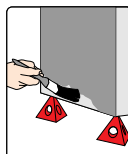

No.	pcs	
09220	6	24

PL Pędzel angielski
GB Flat paint brush
D Flachpinsel
RUS Кисть флейцевая

CZ Anglický štětec
RO Pensulă englezească
H Laposecset
E Brocha plana



No.	W (mm)	
09521	25	50
09522	36	50
09523	50	50
09524	63	50
09525	76	50

PL Pędzel angielski profesjonalny
GB Flat paint brush profi
D Flachpinsel
RUS Кисть флейцевая проф

CZ Anglický štětec profesionální
RO Pensulă englezească profesională
H Profesionális laposecset
E Brocha plana prof.



No.	W (mm)	
09531	25	50
09532	36	50
09533	50	50
09534	62	50
09535	75	50
09536	87	50
09537	102	50

Plastering & bricklaying tools / Narzędzia budowlane i malarskie

PL Pędzel kaloryferowy
GB Angled paint brush
D Heizkörperpinsel
RUS Кисть радиаторная

CZ Štětec na topná tělesa
RO Pensulă pt. calorifere
H Radiátorecset
E Brocha angulara de radiadores



No.	W (mm)	
09560	25	50
09561	36	50
09562	50	50

PL Pędzel okrągły
GB Round paint brush
D Ringpinsel
RUS Кисть круглая

CZ Kulatý štětec
RO Pensula rotundă
H Marokceset
E Brocha redonda



No.	W (mm)	
09581	20	50
09583	30	50
09585	40	50
09587	50	50
09589	60	50

PL Pędzel do tapet
GB Brush for wallpapers
D Flächenstreicher
RUS Макловица

CZ Štětec na tapety dřevěný
RO Bidinea profi pt. tapet
H Ecset fa tapetákhöz
E Brocha de empapelar madera



No.	mm	
09636	110	30
09638	130	30
09640	140	30
09642	150	30

PL Ławkowiec profesjonalny
GB Paint brush
D Malerbürste
RUS Макловица профи

CZ Natírací kartáč profesionální
RO Bidinea profesională
H Profesionális kenőkefe
E Brocha prof.



No.	mm	
09647	170	10
09648	180	10
09649	190	10

PL Chłapacz PCV
GB Paint brush
D Deckenbürste
RUS Макловица ПВХ

CZ Smeták PVC
RO Bidinea PVC
H PVC meszelő
E Brocha de PVC

PVC + COCONUT FIBER
PCV + WŁOKNO KOKOSOWE



No.	mm	
09651	60x170	30

PL Pędzle malarskie
GB Paint brushes
D Pinselset
RUS Набор кистей

CZ Sada malířských štětů
RO Set pensule
H Festőecset készlet
E Brochas de pintar



No.	W (mm)	pcs	
09920	25; 36; 50	3	25/200
09930	36; 50; 63	3	40/160
09950	13; 25; 36; 50; 63	5	25/100

PL Ławkowiec PET
GB Paint brush
D Malerbürste
RUS Макловица

CZ Natírací kartáč
RO Bidinea
H Kenőkefe
E Brocha



No.	mm	
09650	70x170	12

PL Smolowiec
GB Brush for pitch
D Pechstein
RUS Смоляной камень

CZ Kartáč asfaltěřský
RO Perle pt. asfalt
H Kátránykenő kefe
E Brocha para alquitrán



No.	mm	
09653	195	30

PL Folia malarska
GB Painting sheet
D Abdeckfolie
RUS Плёнка защитная

CZ Malířská fólie
RO Folie de vǎruit
H Festófolia
E Lona protectora de pintura

4x5
m



No.	m	
09462	4x5	40

PL Folia budowlana
GB Sheet for construction works
D Abdeckplane
RUS Плёнка защитная

CZ Stavební folie
RO Folie pt. construcții
H Építési fólia
E Lona protectora

4x5
m



No.	m	
09463	4x5	20

PL Folia ochronna budowlana
GB Sheet for construction works
D Abdeckplane
RUS Плёнка защитная

CZ Stavební folie
RO Folie pt. construcții
H Építési fólia
E Lona protectora

4x5
m



No.	m	
09457	4x5	15

PL Folia budowlana mocna
GB Sheet for construction works
D Abdeckplane
RUS Плёнка защитная

CZ Stavební folie
RO Folie pt. construcții
H Építési fólia
E Lona protectora

4x5
m



No.	m	
09459	4x5	10

PL Worki na gruz, mocne
GB Debris bags
D Müllsäcke stabil
RUS Мешки для щебня

CZ Pytle na suť
RO Saci pt. demolari
H Sítkes zsák
E Bolsas para escombros



No.	l	pcs packing	µm	
09475	80	10	142	10
09476	80	3	142	10
09477	120	10	142	10
09478	120	3	142	10

PL Worki na odpady budowlane
GB Construction waste bags
D Müllsäcke
RUS Мешки для строительного мусора

CZ Pytle na stavební odpad
RO Saci gunoi pt. santier
H Zsák építési törmelékhez
E Bolsas para desperdicios de construcción



No.	l	pcs packing	µm	
09470	80	10	40	30
09471	120	15	60	10

PL Taśma papierowa samoprzylepna
GB Self adhesive paper tape
D Papierband selbstklebend
RUS Лента малярная бумажная
CZ Páska papírová samolepicí
RO Banda adeziva hartie
H Ontapadó papírszalag
E Cinta de papel adhesiva

25 m 50 m



No.	W (mm)	L (m)	
75270	19	25	12/48
75271	25	25	36
75272	30	25	10/40
75273	38	25	6/24
75274	48	25	6/24
75285	25	50	9/36
75286	30	50	10/40
75287	38	50	6/24
75288	48	50	6/24

PL Taśma aluminiowa
GB Aluminium tape
D Aluminiumband
RUS Лента алюминиевая

CZ Hliníková páska
RO Bandă aluminiu
H Aluminium szalag
E Cinta de aluminio



No.	W (mm)	L (m)	
75140	48	10	36
75141	48	50	24

PL Taśma tekstylna „DUCT”
GB „DUCT” tape
D Textilband „DUCT”
RUS Лента текстильная „DUCT”

CZ Textilní páska „DUCT”
RO Bandă textilă „DUCT”
H „DUCT” textil szalag
E Cinta textil „DUCT”



No.	W (mm)	L (m)	
75238	48	10	36
75239	38	50	32
75240	48	50	24

PL Taśma dwustronna do wykładzin
GB Double-sided carpet tape
D Doppelseitiges Klebeband für Auslegware
RUS Лента двусторонняя для коврового покрытия и линолеума
CZ Obojstranná lepicí páska (na podlahové krytiny)
RO Bandă cu două părți adezive pt. mochetă
H Kétoldalas szalag szőnyegpadlókhöz
E Cinta doble cara para alfombras



No.	W (mm)	L (m)	
75260	50	5	48
75261	50	10	36
75262	50	25	24

PL Taśma dwustronna na folii
GB Double-sided tape
D Doppelseitiges Band auf PP-Folie
RUS Лента двусторонняя на базе полипропиленовой пленки
CZ Obojstranná páska na PP fólii
RO Bandă cu două fețe pt. folii
H Kétoldalas
E Cinta doble cara sobre la base de PP



No.	W (mm)	L (m)	
75245	50	5	72
75246	50	10	72
75247	50	25	36

PL Taśma samoprzylepna dwustronna
GB Mounting tape
D Doppelseitiges montageband
RUS Двусторонняя монтажная лента

CZ 31 VDP PŘÍMÁ GRAMYRNÁ
RO Scotch cu banda dubla
H Kétoldalas ragasztószalag
E Cinta adhesiva, ambos lados



No.	W (mm)	L (m)	
75100	19	2.25; 5	12/96

PL Taśma pakowa brązowa
GB Packing tape, brown
D Verpackungsband aus PP, braun
RUS Лента упаковочная полипропиленовая коричневая
CZ Balící páska PP hnědá
RO Bandă ambalare PP maro
H PP barna ragasztószalag
E Cinta de embalaje PP marrón



No.	W (mm)	L (m)	
75301	48	40	72
75302	48	66	36

PL Taśma pakowa przezroczysta
GB Packing tape, transparent
D Verpackungsband aus PP, durchsichtig
RUS Лента упаковочная полипропиленовая прозрачная
CZ Balící páska PP průhledná
RO Bandă ambalare PP transparentă
H Átlátszó ragasztószalag
E Cinta de embalaje PP transparente



No.	W (mm)	L (m)	
75303	48	40	72
75304	48	66	36

PL Taśma pakowa
GB Packing tape
D Band
RUS Скотч упаковочный прозрачный

CZ Balící páska
RO Banda scotch
H Csomagolószalag
E Cinta de embalaje



No.	W (mm)	L (m)	
75300	48	45	12/120

PL Taśma PCV do użytku zewnętrznego
 GB PVC tape
 D PVC Band
 RUS Лента PVC

CZ Páska PVC
 RO Bandă PVC
 H Kétdalás PVC
 E Cinta PVC

INSIDE AND OUTSIDE APPLICATION (UP TO 2 WEEKS)
 ZASTOSOWANIE WENIATRZ I NA ZEWNATRZ (DO 2 TYGODNI)

UV PROOF
 ODPORNA NA PROMIENIOWANIE UV

PVC



No.	W (mm)	L (m)	
75030	38	33	50
75031	48	33	50

PL Wiadro budowlane
 GB Plastic bucket
 D Baueimer
 RUS Ведро строительное
 CZ Stavební vědro
 RO Găleată pt. construcții
 H Kőműves vödör
 E Cubo de obra



No.	l	
06388	10	900
06390	12	680
06392	20	390
06393	16	450

PL Wiadro budowlane z wylewką
 GB Plastic bucket
 D Baueimer
 RUS Ведро строительное со сливом
 CZ Stavební vědro
 RO Găleată pt. construcții
 H Kőműves vödör
 E Cubo de obra con pico

12l



No.	l	
06391	12	720

PL Wiadro malarskie
 GB Painting bucket
 D Malereimer
 RUS Ведро строительное



No.	l	mm	
09400	14	360x250x225	315

PL Kastrა budowlana
 GB Tub for mass mixing
 D Mörtelkasten
 RUS Ковета для перемеш.раствора

CZ Stavební vědro
 RO Vas plastic constructii
 H Kőműves vödör
 E Caba de obra



No.	l	
06397	40	110
06398	65	100
06399	90	160

PL Kastrа budowlana
 GB Tub for mass mixing
 D Mörtelkasten
 RUS Ковета для перемеш.раствора

CZ Stavební vědro
 RO Vas plastic constructii
 H Kőműves vödör
 E Caba de obra



No.	l	
06394	40	210
06395	60	210
06396	90	120

PL Wiadro ocynkowane
 GB Galvanized bucket
 D Baueimer
 RUS Ведро
 CZ Vědro
 RO Găleată
 H Kőműves vödör
 E Cubo



No.	l	
89560	5	900
89561	7	450
89562	10	480
89563	12	360
89564	15	270

PL Uchwyt do szyb
 GB Suction lifter
 D Glas-Gummissauger
 RUS Держатель-присоска для установки стекол

CZ Podtlakový úchyt na sklo
 RO Ventuze
 H Szélvédő klemelő
 E Elevadores tipo ventosa

115 Ømm 40 kg



No.	Ø (mm)	kg	
05300	115	40	48

PL Uchwyt do szyb
GB Suction lifter
D Glas-Gummissauger
RUS Держатель-присоска для установки стекол

CZ Podtlakový úchyt na sklo
RO Ventuze
H Szélvédő kiemelő
E Elevadores tipo ventosa

115 Ømm 70 kg



No.	Ø (mm)	kg	Icon
05301	115	70	24

PL Uchwyt do szyb
GB Suction lifter
D Glas-Gummissauger
RUS Держатель-присоска для установки стекол

CZ Podtlakový úchyt na sklo
RO Ventuze
H Szélvédő kiemelő
E Elevadores tipo ventosa

115 Ømm 100 kg



No.	Ø (mm)	kg	Icon
05302	115	100	12

PL Uchwyt do szyb
GB Suction lifter
D Glas-Gummissauger
RUS Держатель-присоска для установки стекол

CZ Podtlakový úchyt na sklo
RO Ventuze
H Szélvédő kiemelő
E Elevadores tipo ventosa

115 Ømm 40 kg

AI



No.	Ø (mm)	kg	Icon
05311	115	40	50

PL Uchwyt do szyb
GB Suction lifter
D Glas-Gummissauger
RUS Держатель-присоска для установки стекол

CZ Podtlakový úchyt na sklo
RO Ventuze
H Szélvédő kiemelő
E Elevadores tipo ventosa

115 Ømm 70 kg

AI



No.	Ø (mm)	kg	Icon
05312	115	70	10

PL Hak budowlany
GB Hook
D Mauerhaken
RUS Крюк строительный

CZ Slabovní hák
RO Cârlig de construcții
H Építőipari horog
E Gancho de obra

Icon



No.	Icon
34950	25

PL Ołówek stolarski
GB Carpenter's pencil
D Zimmermannsbleistift
RUS Карандаш столярный

CZ Tesařův WAND
RO Creion de tâmplărie
H Asztalos ceruza
E Lapiz de carpintero

180 mm



No.	L (mm)	pcs/pack	Icon
09180	180	12	60/240

PL Temperówka do ołówek stolarskich
GB Carpenter's pencil sharpener
D Zimmermann-Bleistift-Anspitzer
RUS Точилка для столярных карандашей

CZ Ořezávkó na tesařův WAND
RO Ascuzitoare pt. creioane de tâmplărie
H Ceruzahegyező
E Sacarpuntas para lápiz de carpintero

Icon



No.	Icon
09190	40/240

PL Giętarka łożyskowa do drutu
GB Bearing bender for bar
D Drahtbiegevorrichtung, mit Lager
RUS Гибочное подшипниковое устройство проволоки

CZ Ohybač s ložiskem
RO Dispozitiv pt. îndoliti suport sârmă
H Csapágyas dróthajlító
E Dobladora de alambre con rodamento

Icon



No.	Ø (mm)	mm	bearing / łożysko (mm)	Icon
49805	6-8	17x17x5	35x15	2
49806	10-14	25x20x5	45x20	2

PL Giętarka do drutu zbrojeniowego **CZ** Ohýbačka armovacího drátu
GB Bender for reinforcement bar **RO** Dispozitiv pt. îndoit sârmă de armare
D Biegevorrichtung für Bewehrungsdraht **H** Betonvas hajlító
RUS Гибочное устройство арматурной проволоки **E** Dobladora de alambre de reforzamiento



No.	Ø (mm)	mm	
49800	6-8	16x12x5	4
49801	10-12	25x16x6	4
49802	14-16	25x16x6	2

Memo

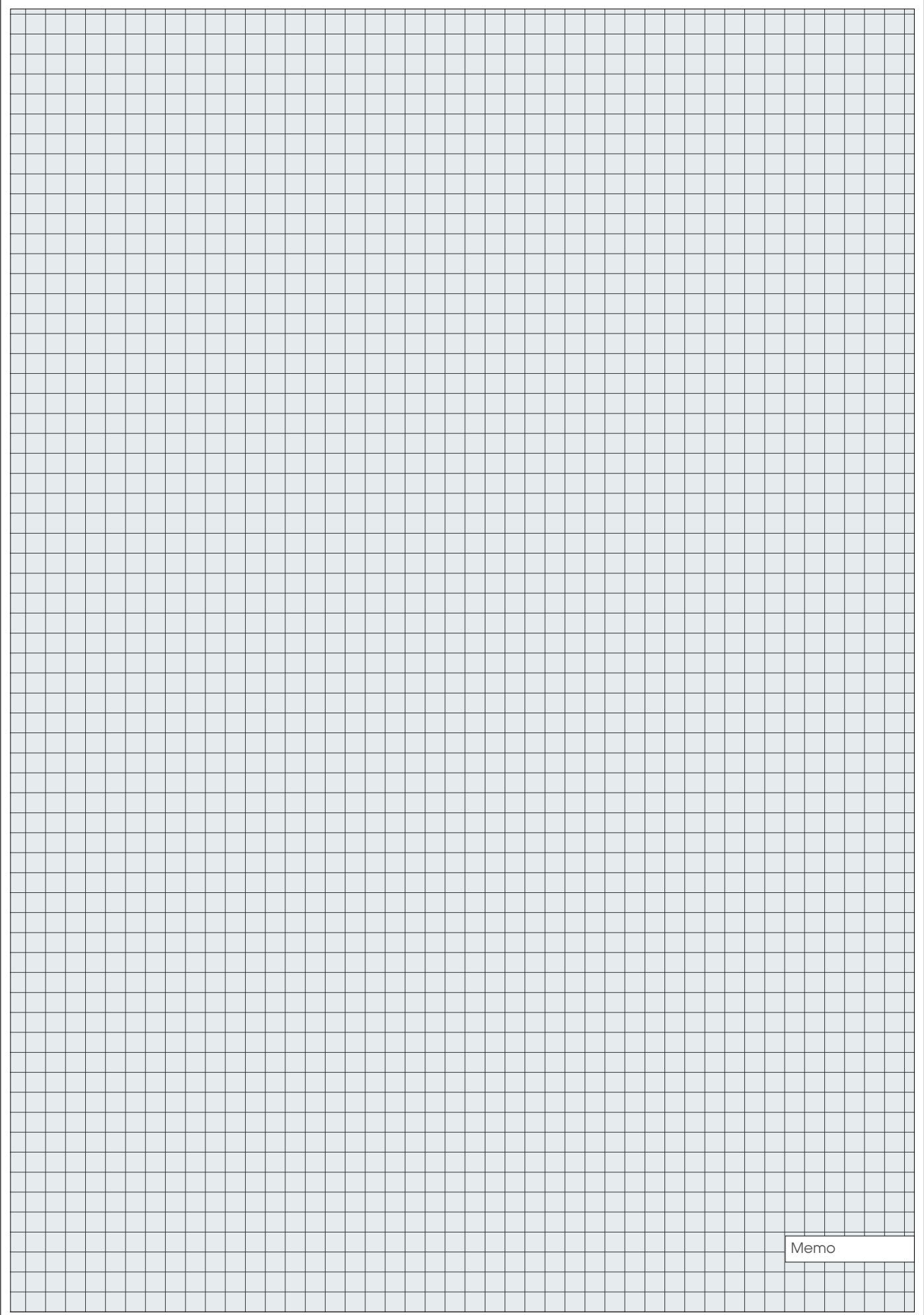

Memo

12

Measuring tools Narzędzia miernicze

Measuring tapes
Miary zwijane

.....150



Wooden folding rules
Miary składane drewniane

.....151



Plastic folding rules
Miary składane z tworzywa

.....151



Feeler gauges
Szczelinomierze

.....151



Vernier calipers
Suwmiarki

.....151-152



Chalk lines
Sznury traserskie

.....152



Ropes & lines
Sznury i linki

.....152-154



Plumb bobs
Piony murarskie

.....155



Try squares
Kątowniki stolarskie

.....155



Rulers
Przymiary

.....155-156



Electronic measuring tools
Elektroniczne urządzenia pomiarowe

.....156



Levels
Poziomnice

.....156-157



PL Miara zwiżjana
GB Measuring tape
D Rollbandmass
RUS Рулетка
CZ Měřicí pásmo
RO Rulete din
H Mérőszalag
E Flexometro



No.	L (m)	W (mm)	
10101	2	16	12/120
10104	3	16	12/120
10106	5	16	12/120
10109	7.5	19	6/60
10111	10	25	6/60

PL Miara zwiżjana
GB Measuring tape
D Rollbandmass
RUS Рулетка
CZ Měřicí pásmo
RO Rulete din
H Mérőszalag
E Flexometro



No.	L (m)	W (mm)	
10122	2	16	12/120
10123	3	16	12/120
10125	5	19	12/120
10128	7.5	25	6/60
10129	10	25	6/60

PL Miara zwiżjana
GB Measuring tape
D Rollbandmass
RUS Рулетка
CZ Měřicí pásmo
RO Rulete din
H Mérőszalag
E Flexometro



No.	L (m)	W (mm)	
10130	2	16	12/120
10133	3	16	12/120
10135	5	16	12/120
10138	8	25	6/60
10139	10	25	6/60

PL Miara zwiżjana
GB Measuring tape
D Rollbandmass
RUS Рулетка
CZ Měřicí pásmo
RO Rulete din
H Mérőszalag
E Flexometro



No.	L (m)	W (mm)	
11603	3	16	12/120
11605	5	19	12/120
11608	8	25	6/60

12

PL Taśma miernicza stalowa
GB Steel measuring tape
D Rollbandmass
RUS Мерная лента стальная

CZ Měřicí pásmo ocelové
RO Ruleta din oțel
H Acél mérőszalag
E Cinta de medir de acero



No.	L (m)	W (mm)	
12100	10	10	25/50
12200	20	10	25/50
12300	30	10	10/30
12500	50	10	10/30

PL Miara zwiżjana stalowa
GB Steel measuring tape
D Rollbandmass
RUS Рулетка

CZ Měřicí pásmo ocelové
RO Ruleta din oțel
H Acél mérőszalag
E Flexometro de acero



No.	L (m)	W (mm)	
12502	20	10	30
12503	30	10	30

PL Taśma miernicza stalowa, geodezyjna
GB Steel measuring tape
D Rollbandmass
RUS Мерная лента стальная геодезическая

CZ Měřicí pásmo ocelové
RO Ruleta cu picior
H Acél mérőszalag
E Cinta de medir de acero geodezico



No.	L (m)	
13200	20	10/20
13300	30	10/20
13500	50	10/20

PL Taśma miernicza z włókna szklanego
GB Fibreglass measuring tape
D Rollbandmass
RUS Лента мерная фибергласс

CZ Měřicí pásmo /skleněné vlákno/
RO Ruleta fibra sticlă
H Mérőszalag /üvegszál/
E Cinta de medir /fibra cristal/



No.	L (m)	packing	
14100	10		20/100
14200	20		12/60
14300	30		12/60
14500	50		10/30

PL Miara drewniana, składana, okuta
 GB Wooden folding rule
 D Gliedermasstab
 RUS Метр складной деревянный

CZ Měřicí pásmo dřevěné skladané /okované/
 RO Metru tamplar lemn
 H Fa colstok /vasalt/
 E Metro de madera, plegable /articulado/



No.	L (m)	
15010	1	24/480
15020	2	12/240

PL Miara drewniana, składana, okuta
 GB Wooden folding rule
 D Gliedermasstab
 RUS Метр складной деревянный

CZ Měřicí pásmo dřevěné skladané /okované/
 RO Metru tamplar lemn
 H Fa colstok /vasalt/
 E Metro de madera, plegable /articulado/



No.	type	L (m)	
15004	PERFECT B-Ž	1	20/200
15006	PERFECT B-Ž	2	10/100

PL Miara drewniana, składana, okuta
 GB Wooden folding rule
 D Gliedermasstab
 RUS Метр складной деревянный

CZ Měřicí pásmo dřevěné skladané /okované/
 RO Metru tamplar lemn
 H Fa colstok /vasalt/
 E Metro de madera, plegable /articulado/



No.	type	L (m)	
15005	PERFECT B	1	20/200
15007	PERFECT B	2	10/100

PL Miara składana
 GB Folding rule
 D Klappbares Massband
 RUS Метр складной

CZ Měřicí pásmo skladané
 RO Metru armat
 H Famerce
 E Metro plegable



No.	L (m)	W (mm)	
15071	1	13	10/200
15072	2	16	5/100

PL Miara plastikowa
 GB Plastic folding rule
 D Kunststoffgliedermasstab
 RUS Метр складной пластмассовый

CZ Měřicí pásmo plastové skladané
 RO Metru de plastic
 H Műanyag, összecusukható mérce
 E Metro de plástico, plegable



No.	L (m)	
15050	1	20/200
15070	2	12/120

PL Szczelnomierz
 GB Feeler
 D Fühlerlehre
 RUS Щупы

CZ Spároměr
 RO Lere
 H Hézagmérő
 E Calibre de fisuras



No.	mm	pcs	
15130	0.05-1.00	13	15/300
15200	0.05-1.00	20	10/200

PL Suwmiarka
 GB Vernier caliper
 D Messschieber
 RUS Штангенциркуль

CZ Posuvné měřítko
 RO Şubler
 H Tolómérő
 E Calibre



No.	L (mm)	mm	packing	
15100	150	0.05		40
15110	150	0.02		10/100

PL Suwmiarka zegarowa
 GB Dial caliper
 D Präzisions-Uhrmessschieber
 RUS Штангельциркуль стрелочный

CZ Posuvné měřítko hodinové
 RO Sublier cu cadran
 H Órás tolómérő
 E Calibre dial



No.	L (mm)	mm	
15220	150	0.02	10/50

PL Suwmiarka elektroniczna
GB Digital caliper
D Digital Messschieber
RUS Штангенциркуль электронный

CZ Posuvné měřítko elektronické
RO Şubler electronic
H Elektronikus tolómérő
E Calibre electrónico

150
mm



No.	L (mm)	mm	
15240	150	0.03	10/50

PL Sznur traserski
GB Chalk line
D Schnurlot
RUS Шнур-отвес
малярный

CZ Orysovací šňůra
RO Şnur de trasat
H Kicsapózsínor
E Cordel tizador

15m



No.	L (m)	
17500	15	10/100

PL Sznur traserski
GB Chalk line
D Schnurlot
RUS Шнур-отвес малярный

CZ Orysovací šňůra
RO Şnur de trasat
H Kicsapózsínor
E Cordel tizador

15m

AI



No.	L (m)	
17501	15	10/100

PL Sznur traserski z kredą niebieską
GB Chalk line & blue chalk
D Schlagschnur mit Kreide
RUS Шнур-отвес малярный с синней краской

CZ Orysovací šňůra
RO Fir trasare si praful de creta albastra
H Kicsapózsínor
E Cordel tizador con tiza azul

15m

115g



No.	L (m)	g	
17505	15	115	10/60

PL Kreda traserska
GB Blue / red chalk
D Kreide blau/rot
RUS Краска для шнура

CZ Křída trasovací
RO Praful de creta pt. trasat
H Jelölő krétapor
E Tiza azul/rojo

115g



No.	g	colour / kolor	
17507	115		20/80
17508	115		20/80

PL Sznurek murarski
GB Builders line
D Maurerschnur
RUS Шнур - причалка

CZ Šňůra zednická
RO Sfoară pt. zidari
H Kőműves zsinór
E Cuerda de albañil

40
m



No.	L (m)	
17490	40	80

PL Sznurek murarski
GB Builders line
D Maurerschnur
RUS Шнур - причалка
CZ Šňůra zednická
RO Sfoară pt. zidari
H Kőműves zsinór
E Cuerda de albañil

75
m

EASY
ROLL-ON
LÁTVE
ROZWIĄZANIE

PE LINE
LINKA PE

PUSHING INTO
SOFT EARTH
MOZLIWOŚĆ WPIĘCIA
W MIĘKKA ZIEMIE



No.	L (m)	
17495	75	12/48

PL Sznurek murarski
GB Builders line
D Maurerschnur
RUS Шнур - причалка

CZ Šňůra zednická
RO Sfoară pt. zidari
H Kőműves zsinór
E Cuerda de albañil



No.	L (m)	colour / kolor	
17488	50		60
17489	100		60

PL Sznurek murarski, polipropylenowy
GB Polypropylene bricklayer's string
D Maurerschnur aus Polypropylen
RUS Полипропиленовый шнур-причалка для каменщиков

CZ Šňůra zednická polypropylenová
RO Șnur de zidărie din polietilena
H Kőműves zsinór, polipropilén
E Cordel de albañileria

PP



No.	Ø (mm)	L (m)	
17470	1.7	50	60/240
17471	1.7	100	30/120
17473	2.0	50	60/240
17474	2.0	100	30/120

PL Sznurek murarski polietylenowy
GB Polyethylene bricklayer's string
D Maurerschnur aus Polyäthylen
RUS Полиэтиленовый шнур-причалка для каменщиков

CZ Šňůra zednická polyetylenová
RO Șnur de zidărie din polietilena
H Kőműves zsinór, polietilén
E Cordel de albañileria de polietileno

PE



No.	Ø (mm)	L (m)	
17480	1.7	50	60/240
17481	1.7	100	30/120
17483	2.0	50	60/240
17484	2.0	100	30/120

PL Linka pleciona polipropylenowa
GB Polypropylene sennit line
D Geflochtenes Seil aus Polypropylen
RUS Полипропиленовый плетённый трос

CZ Lano pletené polypropylenové
RO Coarda împletită din polipropilena
H Polipropilén fonott kötél
E Cuerda trenzada de polipropileno

PP



No.	Ø (mm)	L (m)	
69502	4	400	4
69503	5	250	4
69490	6	20	36
69504	6	250	4
69491	8	20	25
69505	8	300	2
69492	10	20	20
69506	10	200	2
69493	12	20	15
69507	12	180	1
69494	14	20	10
69508	14	110	1
69509	16	80	1
69510	18	70	1

PL Linka pleciona polipropylenowa
GB Polypropylene sennit line
D Geflochtenes Seil aus Polypropylen
RUS Полипропиленовый плетённый трос

CZ Lano pletené polypropylenové
RO Coarda împletită din polipropilena
H Polipropilén fonott kötél
E Cuerda trenzada de polipropileno

PP



No.	Ø (mm)	L (m)	
69521	4	20	50

PL Sznurek PP pleciony, uniwersalny
GB Universal PP sennit string
D PP-Schnur, geflochten, universell
RUS Плетённый, универсальный шнур PP

CZ Šňůra PP pletená univerzální
RO Șnur PP împletit, universal
H PP fonott kötél, univerzális
E Cordel trenzado universal PP

PP



No.	Ø (mm)	L (m)	
69620	3	10	50
69621	3	20	40

PL Lina jutowa skręcana
GB String jute rope
D Verdrillt seil aus Jute
RUS Кручёный джутовая канат

CZ Lano jutová kroucená
RO Cablu răsucit de iută
H Juta sodrott kötél
E Cable de yute torcido

PP



No.	Ø (mm)	L (m)	
69574	10	30	15
69575	10	50	10
69579	12	50	6
69580	14	10	24
69583	14	50	4
69587	16	50	4

PL Lina jutowa skręcana
GB String jute rope
D Verdriht seil aus Jute
RUS Крученый джутовый канат

CZ Lano jutová kroucená
RO Cablu răsucit de lută
H Juta sodrott kötél
E Cable de yute torcido



No.	Ø (mm)	L (m)	
69590	18	30	4
69591	18	50	2
69592	20	10	10
69594	20	30	2
69595	20	50	2
69596	25	10	6
69597	25	20	2
69598	25	30	2
69599	30	10	4
69600	30	20	2
69601	40	10	2
69602	40	20	1

PL Sznurek pakowy, jutowy
GB Packing jute string
D Packschnur, aus Jute
RUS Паковочная, джутовая верёвка

CZ Šňůra ucpávková jutová
RO Șnur de împachetat, de lută
H Csomagkötöző spárga, juta
E Cordel de yute para embalaje



No.	dkg	
69630	5	112
69631	10	100

PL Nici iniane, dratwa
GB Flax thread, twine
D Leinenfaden, Pechfaden
RUS Льняные нити, драфта

CZ Nítě lněné, dratev
RO Fire de ln, fire
H Len cérna, fonál
E Hilo de lino, cabo de zapatero



No.	dkg	
69635	10	28
69637	25	18

PL Linka pleciona polipropylenowa
GB Polypropylene sennit line
D Geflochtenes Seil aus Polypropylen
RUS Полипропиленовый плетёный трос

CZ Lano pletené polypropylenové
RO Coarda împletită din polipropilena
H Polipropilén fonott kötél
E Cuerda trenzada de polipropileno



No.	Ø (mm)	L (m)	
69522	6	30	30

PL Lina igłowa
GB Needle rope
D Nadelseil
RUS Игольный трос

CZ Lano s jádrem opletené
RO Cablu ac
H Tűfonatos kötél
E Cable acalabrotado



No.	Ø (mm)	L (m)	
69539	8	10	30
69540	8	20	20
69542	10	10	25
69543	10	20	15
69546	12	20	10

PL Sznurek PP do podwiązki wełny izolacyjnej
GB Spliced wire polypropylene string
D Polypropylen erntegar
RUS Шнур полипропиленовый
CZ Provázek polypropylenový
RO Snur din polipropilena
H Špagát polypropylenový
E Cuerda



No.	Ø (mm)	L (m)	
69608	2.5	200	100
69609	2.5	300	80
69610	2.5	450	50
69612	2.5	1000	24
69613	2.5	2000	12

PL Linka pleciona, elastyczna
GB Elastic sennit line
D Geflochtenes Seil, elastisch
RUS Плетёный, эластичный трос

CZ Lano pletené elastické
RO Coarda împletită, elastică
H Fonott kötél, rugalmas
E Cuerda trenzada elástica



No.	Ø (mm)	L (m)	
69550	6	150	1
69551	8	100	1
69552	10	100	1

- PL Pion murarski
GB Plumb bob
D Senklot
RUS Отвес со шнуром
- CZ Murařská centrace
RO Fir cu plumb
H Kőmőves függőőn
E Plomada albañil



No.		
17300		200

- PL Kařownik stolarski
GB Try square
D Zimmermannswinkel
RUS Угольник столярный
- CZ Truhlářský ůhelník
RO Echer (unghi drept) de tãmplãrie
H Asztalos derékszög
E Escuadra de metalo



No.	mm	
18250	250	12/120
18300	300	12/120
18350	350	12/120

- PL Kařownik stolarski
GB Try square
D Zimmermannswinkel
RUS Угольник столярный
- CZ Truhlářský ůhelník
RO Echer (unghi drept) de tãmplãrie
H Asztalos derékszög
E Escuadra de metalo



No.	mm	
18201	200x300	24/48
18200	400x600	12/24

- PL Kařownik aluminiowy
GB Aluminium try square
D Alu-zimmermannswinkel
RUS Угольник столярный алюминированный
- CZ Truhlářský ůhelník
RO Echer (unghi drept) de tãmplãrie
H Asztalos derékszög
E Escuadra



No.	mm	
18360	250	12/48
18361	300	10/40
18362	350	10/40

- PL Kařownik z podporkã
GB Angle bar with a support
D Winkel mit Stütze
RUS Угольник с пяткой
- CZ ůhelník s dorazem
RO Cornier cu stand
H Tãmaszos derékszögölő
E Escuadra con soporte



No.	mm	
18501	350	30
18502	500	30
18503	750	20
18504	1000	10

- PL Kařomierz nastawny
GB Bevel protractor
D Winkelmesser
RUS Угольник регулируемый
- CZ Nastavitelný ůhloměr
RO Echer reglabil
H Állítható szögmérő
E Callbrador de biseles



No.	mm	
18797	350	10
18798	500	10
18799	750	10

- PL Skoñnica drewniana
GB Bevel protractor
D Schmiege
RUS Угольник регулируемый
- CZ Nastavitelný ůhloměr
RO Echer reglabil
H Állítható szögmérő
E Callbrador de biseles



No.	mm	
18800	270	80
18810	400	60

- PL Przymiar budowlany
GB Carpenter's ruler
D Zeichen-massstab
RUS Линейка с рукояткой
- CZ Měřidlo stavební
RO Ríglã de tãmplãrie
H Kőmőves vonalzó
E Regla de obra



No.	mm	
19750	750	10/40

PL Przymiar aluminiowy, uchwyty, 2 libelki
 GB Aluminium ruler, 2 vials
 D Alu zeichen-massstab 2-lib
 RUS Линейка столярн. алюминиевая

CZ Měřidlo hliníkové
 RO Rigla de aluminiu cu 2 bule
 H Alumínium vonalzó
 E Regla de aluminio, mango, division 2-burbujas



No.	mm	vials / libelki	
19770	600	2	12/24

PL Dalmierz ultradźwiękowy z laserem
 GB Ultrasonic distance meter with laser
 D Ultraschall Entfernungsmesser mit Laserpointer
 RUS Ультразвуковой измеритель расстояния
 CZ Ultrazvukový měřič vzdáleností
 RO Aparat masurat distanta cu laser
 H Léyeres, ultrahangos távolságmérő
 E Distanciómetro de ultrasonido con láser

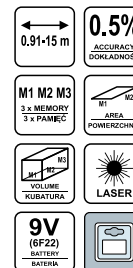

No.	↔ m	battery / bateria	
81782	0.91-15	9V (6F22)	6/36

PL Wykrywacz metalu i przewodów
 GB Metal and voltage detector
 D Ortungsgerät für metal und leitungen
 RUS Детектор металла и токоведущих проводов

CZ Metalo ir átampas detektorius
 RO Detector metale/electricitate
 H Fém- és feszültség detektor
 E Detector de metalo y cables

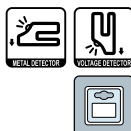

No.		
81781		20

PL Wykrywacz metalu i przewodów
 GB Metal and voltage detector
 D Ortungsgerät für metal und leitungen
 RUS Детектор металла и токоведущих проводов
 CZ Metalo ir átampas detektorius
 RO Detector metale/electricitate
 H Fém- és feszültség detektor
 E Detector de metalo y cables



No.	battery / bateria	
81785	9V (6F22)	20

PL Pirometr mini
 GB Pirometer mini
 D Pirometer Mini
 RUS Мини-пиrometer
 CZ Pyrometr mini
 RO Pirometru mini
 H Mini pirométer
 E Minipirometro



No.		
81761		10/40

PL Pirometr o zmiennej emisyjności
 GB Pirometer with variable emissivity
 D Pirometer mit variabler Emissionsfähigkeit
 RUS Пиrometer с переменной эмиссионной способностью
 CZ Pyrometr s nastavitelnou emisivitou
 RO Pirometru cu emisivitate variabilă
 H Változó emissziójú pirométer
 E Pirometro de emisividad variable

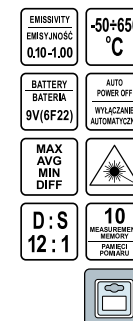

No.		
81762		5/20

PL Higrometr
 GB Hygrometer
 D Hygrometer
 RUS Гигрометр
 CZ Hygrometr
 RO Higrometru
 H Higrométer
 E Higrómetro



No.		
81771		5/20

PL Poziomnica aluminiowa
 GB Aluminium level
 D Wasserwaage
 RUS Уровень

CZ Vodováha
 RO Cumpănă
 H Vízmerék
 E Nivel



No.	L (mm)	vials / libelki	
16340	400	3	20/60
16360	600	3	20/60
16380	800	3	20/60
16400	1000	3	20/60

13

Pneumatic tools **Narzędzia pneumatyczne**

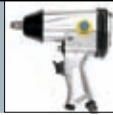
Air tools
Narzędzia pneumatyczne

160-161

Impact wrenches

Klucze udarowe..... 160

Pneumatic grinders

Szlifierki pneumatyczne..... 160

Pneumatic ratchets

Grzechotki pneumatyczne..... 161

Tire inflating guns & heads
Pistolety do pompowania kół
i głowice

161

Pneumatic painting equipment
Narzędzia do malowania

162-167

Spray guns

Pistolety lakiernicze..... 162

Inflating guns

Pistolety do przedmuchiwania..... 163

Washing guns

Pistolety do ropowania..... 163

Pneumatic painting equipment GAV

Narzędzia do malowania GAV..... 163

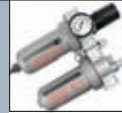
Pneumatic accessories
Akcesoria instalacji
pneumatycznej

167-168

Air filters, regulators & lubricators

Filtry, reduktory i smarownice..... 167

Spiral hoses

Wężę spiralne..... 167

Reinforced hoses

Wężę zbrojone..... 168

Couplers

Złącza..... 168

- PL Klucz pneumatyczny udarowy
 GB Impact wrench
 D Druckluft-schlagschrauber
 RUS Ударный пневматический гайковерт
 CZ Klíč pneumatický
 RO Pistol pneumatic
 H Pneuematikus ütvecsavarozó
 E Llave de percusión

1/4" (6.3 mm) **155** l/min

0-7000 min⁻¹ **0.63** MPa(max)

1/2" (12.5 mm) **312** Nm



$L_{pa} = 84,4 \text{ dB}; L_{wa} = 95,4 \text{ dB}; a_n = 2,6 \pm 2,0 \text{ m/s}^2$

No.	size / rozmiar	l / min	Nm	
81100	1/2" (12.5 mm)	155	312	10

- PL Klucz pneumatyczny z nasadkami
 GB Air impact kit
 D Druckluft-schlagschrauber mit Kraffeinsätzen
 RUS Гайковерт пневматический в комплекте
 CZ Klíč pneumatický s nástavci
 RO Pistol pneumatic cu accesorii
 H Pneuematikus ütvecsavarozó készlet
 E Llave neumático de percusión

9 10 11 13 14 17
19 22 24 27 mm

0.63 MPa(max) 0-7000 min⁻¹

312 Nm 1/2" (12.5 mm)

1/4" (6.3 mm) 1/2" (12.5 mm) 125 mm

155 l/min CrV

MINI OILER OIL POT



$L_{pa} = 84,4 \text{ dB}; L_{wa} = 95,4 \text{ dB}; a_n = 2,6 \pm 2,0 \text{ m/s}^2$

No.	size / rozmiar	l / min	Nm	
81101	1/2" (12.5 mm)	155	312	5

- PL Szlifierka pneumatyczna prosta
 GB Air grinder
 D Druckluft-einhandschleifer
 RUS Пневматическая шлифмашина-патрон
 CZ Bruska přímá pneumatická
 RO Polizor pneumatic
 H Préslevegős sarokcsiszoló
 E Lijadera neumática recta

0.63 MPa(max) 0-22000 min⁻¹ $\varnothing 6 \text{ mm}$

566 l/min 1/4" (6.3 mm)



$L_{pa} = 83,5 \text{ dB}; L_{wa} = 94,5 \text{ dB}; a_n = 1,2 \pm 2,0 \text{ m/s}^2$

No.	size / rozmiar	l / min	min-1	
81108	1/4" (6.3 mm)	566	22000	20

- PL Szlifierka pneumatyczna kątowna
 GB Air angle grinder
 D Druckluft-Winkelschleifer
 RUS Пневматическая углошлифмашина
 CZ Bruska úhlová vzduchová
 RO Polizor pneumatic
 H Préslevegős sarokcsiszoló
 E Lijadera neumática de angulo

1/4" (6.3 mm) **86** l/min $\varnothing 6 \text{ mm}$

0-20000 min⁻¹ **0.63** MPa(max)



$L_{pa} = 90,1 \text{ dB}; L_{wa} = 101,1 \text{ dB}; a_n = 0,7 \text{ m/s}^2$

No.	size / rozmiar	l / min	min-1	
81110	1/4" (6.3 mm)	86	20000	16

- PL Szlifierka pneumatyczna prosta z akcesoriami
 GB Die grinder kit
 D Druckluft-Schrauber mit Schleifaufsätzen
 RUS Комплект для шлифования
 CZ Bruska přímá pneumatická s příslušenstvím
 RO Masina de polizat pneumatica
 H Pneuematikus köszörű készlet
 E Lijadera neumática recta

0.63 MPa(max) 0-22000 min⁻¹ 1/4" (6.3 mm)

566 l/min $\varnothing 3; 6 \text{ mm}$ **10 pcs**



$L_{pa} = 83,5 \text{ dB}; L_{wa} = 94,5 \text{ dB}; a_n = 1,2 \pm 2,0 \text{ m/s}^2$

No.	size / rozmiar	l / min	min-1	
81109	1/4" (6.3 mm)	566	22000	8

- PL Szlifierka pneumatyczna mimośrodowa
 GB Air sander
 D Druckluft-Excenterschleifer
 RUS Шлифмашина эксцентриковая пневматическая
 CZ Bruska pneumatická
 RO Masina de slefuit pneumatica
 H Pneuematikus sarokcsiszológép
 E Lijadera neumática excéntrica

0.63 MPa(max) 0-10000 min⁻¹

396 l/min 150 $\varnothing 15 \text{ mm}$

1/4" (6.3 mm)



$L_{pa} = 72,7 \text{ dB}; L_{wa} = 83,7 \text{ dB}; a_n = 1,44 \text{ m/s}^2$

No.	size / rozmiar	\varnothing (mm)	MPa	
81114	1/4" (6.3 mm)	150	0.63	10

- PL Tarcza polerska do szlifierki pneumatycznej
 GB Disc for air sander
 D Stützeleier für Druckluftexcenterschleifer
 RUS Диск полировочный для пневмошлифмашины
 CZ Disk pro pneumatickou brusku
 RO Masina disc pt. slefuit
 H Csiszolókorong pneumatikus gépekhöz
 E Recambio disco lijadora orbital neumatica



No.	Ø (mm)	min-1	
81115	150	0-10000	10/100

Ø [mm]
150

0-10000min⁻¹
 max.

M8

- PL Grzechotka pneumatyczna
 GB Ratchet air wrench
 D Druckluft-Ratschenschrauber
 RUS Пневмометрцотка
 CZ Uťahovák vzduchový
 RO Antrenor pneumatic
 H Prészevegős beható szerszám
 E Carraca neumática



LpA = 90,8 dB; LwA = 101,8 dB; ah = 1,2 ± 2,0 m/s²

No.	size / rozmiar	l / min	Nm	
81117	1/2" (12.5 mm)	538	68	20

0.63
MPa(max)

0-122
min⁻¹

68
Nm

538
l/min

1/2"
12.5mm

1/4"
(6.3 mm)

- PL Zestaw kluczy pneumatycznych z nasadkami
 GB Impact wrench + ratchet wrench kit
 D Druckluft-Schraubersatz mit zubehör
 RUS Пневмопистолет с пневмометрцоткой и насадками
 CZ Sada pneumatických klíčů
 RO Pistol + cheie pneumatice cu accesorii
 H Pneumatikus racsnikulcs + útvecsavarozó készlet
 E Juego de llaves neumáticas con boquillas



No.	size / rozmiar	pcs	
81141	1/2" (12.5 mm)	17	5

9 10 11 13 14 17
 19 22 24 27 mm

0.63
MPa(max)

1/2"
12.5mm

1/4"
(6.3 mm)

CrV

0-7000min⁻¹

312 Nm
622 l/min

MINI OILER OIL POT

0-150min⁻¹

61 Nm
538 l/min

- PL Zestaw narzędzi pneumatycznych z akcesoriami
 GB Pneumatic tool set
 D Druckluftwerkzeugsatz mit zubehör
 RUS Пневматический инструмент в наборе
 CZ Sada pneumatického nářadí
 RO Set pistol + accesorii pneumatice
 H Légszerszámok készlet
 E Juego de herramientas neumáticas con accesorios



No.	size / rozmiar	Ø (mm)	pcs	
81142	1/2" (12.5 mm)	6	33	2

0-7000min⁻¹

312 Nm
622 l/min

0-4500min⁻¹

481 l/min

0-150min⁻¹

61 Nm
538 l/min

0-22000min⁻¹

566 l/min

1/2"
12.5mm

0.63
MPa(max)

CrV

1/4"
(6.3 mm)

Ø 6mm

MINI OILER OIL POT

10 11 13 14 15 17
 19 22 24 27 mm

- PL Pistolet do pompowania z manometrem
 GB Tire-inflating gun
 D Reifenfüller mit manometer
 RUS Пистолет для накачивания с манометром
 CZ Pistole na čerpaní z manometrem
 RO Pistol de aer pt. pneuri cu manometru
 H Nyomásmérő tehergépkocsikhoz
 E Pistola de bombeo con manometro



No.	bar	
81650	2.8-10	10/40

2.8-10 bar

- PL Głowica do pompowania
 GB Inflating head
 D Klemmnippel (universal)
 RUS Универсальная головка
 CZ Hlava na čerpaní
 RO Cap pt. pompat
 H Pumpafej
 E Cabeza de bombeo



No.	mm	bar	
81653	8	2.8-10	50/300
81661	6	2.8-10	50/300

2.8-10 bar

BRASS MOSIĄDZ

- PL Pistolet natryskowy
- GB Spray gun with fluid cup
- D Lackierpistole mit Fliessbecher
- RUS Пистолет - распылитель с верхним бачком
- CZ 3VARIODORNY Q | Q G&H
- RO Pistol de vopsit cu rezervor inferior
- H Festőpisztoly alsó tartállyal
- E Pistola de barniz



HVLP 
 0.20-0.35MPa
 118-201l/min
 Ø 1.4mm
 1000ml



L_{pa} = 61,2 dB; L_{wa} = 72,2 dB

No.	Ø (mm)	
80901	1.4	10

- PL Pistolet natryskowy
- GB Spray gun with fluid cup
- D Lackierpistole mit Fliessbecher
- RUS Пистолет - распылитель с верхним бачком
- CZ 3VARIODORNY Q | Q G&H
- RO Pistol de vopsit cu rezervor inferior
- H Festőpisztoly alsó tartállyal
- E Pistola de barniz



HVLP 
 118-201l/min
 1.4mm
 600ml
 0.20-0.35MPa



L_{pa} = 58,2 dB; L_{wa} = 69,2 dB

No.	Ø (mm)	
80902	1.4	10

- PL Pistolet natryskowy
- GB Spray gun with fluid cup
- D Lackierpistole mit Fliessbecher
- RUS Пистолет - распылитель с верхним бачком
- CZ 3VARIODORNY Q | Q G&H
- RO Pistol de vopsit cu rezervor inferior
- H Festőpisztoly alsó tartállyal
- E Pistola de barniz



 3,5-5bar
 Ø 1,5mm
 1000ml
 280-450l/min





No.	Ø (mm)	
81617	1.5	20

- PL Pistolet natryskowy
- GB Spray gun with fluid cup
- D Lackierpistole mit Fliessbecher
- RUS Пистолет - распылитель с верхним бачком
- CZ 3VARIODORNY Q | Q G&H
- RO Pistol de vopsit cu rezervor inferior
- H Festőpisztoly alsó tartállyal
- E Pistola de barniz



 3,5-5bar
 Ø 1,5mm
 680ml
 280-450l/min









No.	Ø (mm)	
81618	1.5	20

- PL Zestaw lakierniczy
- GB Spray gun kit
- D Lackierspritzsatz
- RUS Покрасочный набор
- CZ Laková souprava
- RO Set de lacuit
- H Részcs fényezőkészlet
- E Juego de barniz

 5 PCS





 3-6 bar, L=400 mm
 3-5 bar, 950ml
 3-5 bar
 3,5-5bar, 750ml, ø1,5mm, 280-450 l/min
 L=5m







No.	pcs	
81637	5	10

- PL Zestaw lakierniczy
- GB Spray gun kit
- D Lackierspritzsatz
- RUS Покрасочный набор
- CZ Laková souprava
- RO Set de lacuit
- H Részcs fényezőkészlet
- E Juego de barniz

 5 PCS



 3-6 bar, L=400 mm
 3-5 bar, 950ml
 3-5 bar
 3,5-5bar, 750ml, ø1,5mm, 280-450 l/min
 L=5m



No.	pcs	
81638	5	10

PL Pistolet do przedmuchiwania
GB Inflating gun
D Ausblaspistole
RUS Пистолет для продувки

CZ Pistolet na profukování kratká
RO Pistol scurt pt. suflat
H Rövid előléfűvő pisztoly
E Pistola de soplado



No.	bar	
81640	1.2-3	20/40

PL Pistolet do przedmuchiwania z przedłużką
GB Inflating gun with extension
D Gebläsepistole mit Verlängerung
RUS Пистолет для продувки с удлинителем

CZ Pistolet na profukování dlouhá
RO Pistol lung pt. suflat
H Rövid előléfűvő pisztoly
E Pistola de soplado

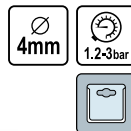

No.	bar	
81644	1.2-3	20/40

PL Pistolet do ropowania
GB Washing gun
D Waschpistole
RUS Пистолет для нефтывания

CZ Pistolet na ropování
RO Pistol (dozator) pt. motorină
H Olajópisztoly
E Pistola de petrolcar



No.	bar	
81647	3-5	10/20

PL Pistolet natryskowy
GB Spray gun with fluid cup
D Lackierpistole mit Fließbecher
RUS Пистолет - распылитель с верхним бачком
CZ 31WBB CD ONRY Q J Q Gät
RO Pistol de vopsit cu rezervor inferior
H Festőpisztoly alsó tartállyal
E Pistola de barniz



No.	cm ³	bar	
GV-0083	1000	4-8	20

PL Pistolet natryskowy
GB Spray gun with fluid cup
D Lackierpistole mit Fließbecher
RUS Пистолет - распылитель с верхним бачком
CZ 31WBB CD ONRY Q J Q Gät
RO Pistol de vopsit cu rezervor inferior
H Festőpisztoly alsó tartállyal
E Pistola de barniz



No.	cm ³	bar	
GV-0062	750	4-8	20

PL Pistolet natryskowy
GB Spray gun with fluid cup
D Lackierpistole mit Fließbecher
RUS Пистолет - распылитель с верхним бачком
CZ 31WBB CD ONRY Q J Q Gät
RO Pistol de vopsit cu rezervor inferior
H Festőpisztoly alsó tartállyal
E Pistola de barniz



No.	cm ³	bar	
GV-0082	1000	4-8	20

PL Pistolet do przedmuchiwania
GB Inflating gun with extension
D Gebläsepistole mit Verlängerung
RUS Пистолет для продувки с удлинителем

CZ Pistolet na profukování dlouhá
RO Pistol lung pt. suflat
H Rövid előléfűvő pisztoly
E Pistola de soplado



No.	bar	
GV-0400	12	100

PL Pistolet do przedmuchiwania
GB Inflating gun with extension
D Gebläsepistole mit Verlängerung
RUS Пистолет для продувки с удлинителем

CZ Pistolet na profukování dlouhá
RO Pistol lung pt. suflat
H Rövid előléfűvő pisztoly
E Pistola de soplado



No.	bar	
GV-0420	12	200

PL Pistolet do ropowania
 GB Washing gun
 D Waschpistole
 RUS Пистолет для нефтявания

CZ Pistolet na ropování
 RO Pistol (dozator) pt. motorină
 H Olajzópisztoly
 E Pistola de petroleaz



No.	bar	
GV-0510	12	18

PL Pistolet do pompowania z manometrem
 GB Tire-inflating gun
 D Reifenfüller manometer
 RUS Пистолет для накачания с манометром

CZ Pistolet na čerpání z manometrem
 RO Pistol presiune cu manometru
 H Indicator de presiune pt. camioane
 E Pistola de bombeo con manometro



No.	bar	
GV-0610	12	100

PL Pistolet do pompowania z manometrem
 GB Tire-inflating gun
 D Reifenfüller manometer
 RUS Пистолет для накачания с манометром

CZ Pistolet na čerpání z manometrem
 RO Pistol presiune cu manometru
 H Indicator de presiune pt. camioane
 E Pistola de bombeo con manometro



No.	bar	
GV-0620	10	100

PL Pistolet do pompowania z manometrem
 GB Tire-inflating gun
 D Reifenfüller manometer
 RUS Пистолет для накачания с манометром

CZ Pistolet na čerpání z manometrem
 RO Pistol presiune cu manometru
 H Indicator de presiune pt. camioane
 E Pistola de bombeo con manometro



No.	bar	
GV-0631	12	25

PL Głowica do pompowania
 GB Universal head
 D Klemmnippel (universal)
 RUS Универсальная головка

CZ Hlava na čerpání
 RO Cap pt. pompat
 H Pumpafej
 E Cabeza de bombeo



No.	Ø (mm)	
GV-0656	6	500/1500
GV-0658	8	250/1000

PL Pistolet do piaskowania ze zbiornikiem
 GB Gun suitable for sand-blasting
 D Sandstrahlpistole
 RUS Пескоструйный пистолет

CZ Pískovací pistole se zásobníkem
 RO Pistol de sablat
 H Homokszóró pisztoly tartállyal
 E Pistola para limpieza con chorro de arena con recip.



No.	cm ³	bar	
GV-0700	1000	6-8	100

PL Pistolet do piaskowania z węzłem
 GB Air sand blaster
 D Pistole zum sandstrahlen
 RUS Пескоструйный пистолет

CZ Pískovací pistole s hadicí
 RO Pistol de sablat
 H Homokszóró pisztoly tömlővel
 E Pistola para limpieza con chorro de arena con manguera



No.	bar	m	
GV-0710	6-8	2	50

PL Pistolet do konserwacji
 GB Gun for sound-deadening treatments
 D Spitzpistole für flächenschutzfluide
 RUS Пистолет для консервирования

CZ Konzervační pistole
 RO Pistol pt. înreținere
 H Karbantartó pisztoly
 E Pistola de conservar con recipiente



No.	cm ³	bar	
GV-0720	1000	6-8	100

- PL Pistolet do konserwacji
 GB Gun for protection and sound-roofing treatments
 D Spitzpistole für flächenschutzfluide
 RUS Пистолет для консервирования
- CZ Konzervační pistole
 RO Pistol pt. intretinere
 H Karbantartó pisztoly
 E Pistola de conservar sin recipiente



No.	bar	
GV-0730	6-8	100

- PL Pistolet do konserwacji z węzłem
 GB Gun for protection and sound-roofing treatments
 D Spitzpistole für flächenschutzfluide
 RUS Пистолет для консервирования
- CZ Konzervační pistole s hadicí
 RO Pistol pt. intretinere, cu furtun
 H Karbantartó pisztoly tömlővel
 E Pistola de conservar sin recipiente con manguera



No.	bar	
GV-0740	6-8	75

- PL Filtr - reduktor
 GB Filter - reducer
 D Druckfilter - druckminderer
 RUS Фильтр - редуктор
- CZ Filtr derukční ventil
 RO Filtru cu reductor
 H Szűrő - nyomáscsökkentő
 E Reductor + filtro



No.	max bar	size / rozmiar	
GV-0861	16	1/2" (12.5 mm)	20

- PL Zespół filtrujący, reduktor + smarownica
 GB Air filter regulator and lubricator
 D Druckfilter-druckminderer - Entöler
 RUS Фильтр-редуктор
- CZ Redukční ventil s odlučovačem oleje
 RO Filtru cu reductor
 H Levegőelőkészítő
 E Juego de filtro reductor + engrasador



No.	max bar	size / rozmiar	
GV-0871	16	1/2" (12.5 mm)	18

- PL Reduktor ciśnienia z manometrem
 GB Pressure reducing valve with manometer
 D Druckminderer mit manometer
 RUS Клапан уменьшения давления с манометром
- CZ Redukční ventil s manometrem
 RO Valva cu reductiepresiune + manometru
 H Nyomáscsökkentő szelep nyomásmérővel
 E Reductor + manometro



No.	max bar	
GV-0925	12	100

- PL Szybkozłącze
 GB Quick coupler
 D Schnellkupplung
 RUS Быстрое соединение
- CZ Rychlospojka
 RO Mufa rapida pt. pistol pneumatic
 H Gyorscsatlakozó
 E Conexión de la entrada de aire



No.	size / rozmiar (M)	
GV-1100	1/4" (6.3 mm)	100/300
GV-1101	3/8" (10.0 mm)	100/300
GV-1102	1/2" (12.5 mm)	100/300

- PL Szybkozłącze
 GB Quick coupler
 D Schnellkupplung
 RUS Быстрое соединение
- CZ Rychlospojka
 RO Mufa rapida pt. pistol pneumatic
 H Gyorscsatlakozó
 E Conexión de la entrada de aire



No.	Ø (mm)	
GV-1121	6	100/300
GV-1122	8	100/300
GV-1123	10	100/300

- PL Szybkozłącze
 GB Quick coupler
 D Schnellkupplung
 RUS Быстрое соединение
- CZ Rychlospojka
 RO Mufa rapida pt. pistol pneumatic
 H Gyorscsatlakozó
 E Conexión de la entrada de aire



No.	size / rozmiar (F)	
GV-1105	1/4" (6.3 mm)	100/300

PL Szybkozłącze
GB Quick coupler
D Schnellkupplung
RUS Быстрое соединение

CZ Rychlospojka
RO Mufa rapida pt. pistol pneumatic
H Gyorscsatlakozó
E Conexión de la entrada de aire



No.	size / rozmiar	
GV-1150	1/4" (6.3 mm)	100/400
GV-1151	3/8" (10.0 mm)	100/400
GV-1152	1/2" (12.5 mm)	100/400

PL Szybkozłącze
GB Quick coupler
D Schnellkupplung
RUS Быстрое соединение

CZ Rychlospojka
RO Mufa rapida pt. pistol pneumatic
H Gyorscsatlakozó
E Conexión de la entrada de aire



No.	size / rozmiar	
GV-1160	1/4" (6.3 mm)	100/400
GV-1161	3/8" (10.0 mm)	100/400

PL Szybkozłącze
GB Quick coupler
D Schnellkupplung
RUS Быстрое соединение

CZ Rychlospojka
RO Mufa rapida pt. pistol pneumatic
H Gyorscsatlakozó
E Conexión de la entrada de aire



No.	Ø (mm)	
GV-1180	6	100/400
GV-1181	8	100/400
GV-1182	10	100/400

PL Szybkozłącze
GB Quick coupler
D Schnellkupplung
RUS Быстрое соединение

CZ Rychlospojka
RO Mufa rapida pt. pistol pneumatic
H Gyorscsatlakozó
E Conexión de la entrada de aire



No.	size / rozmiar	
GV-1200	1/4" (6.3 mm)	500/2000
GV-1201	3/8" (10.0 mm)	500/1000
GV-1202	1/2" (12.5 mm)	250/1000

PL Szybkozłącze
GB Quick coupler
D Schnellkupplung
RUS Быстрое соединение

CZ Rychlospojka
RO Mufa rapida pt. pistol pneumatic
H Gyorscsatlakozó
E Conexión de la entrada de aire



No.	size / rozmiar	
GV-1220	1/4" (6.3 mm)	500/1000
GV-1221	3/8" (10.0 mm)	500/1000

PL Szybkozłącze
GB Quick coupler
D Schnellkupplung
RUS Быстрое соединение

CZ Rychlospojka
RO Mufa rapida pt. pistol pneumatic
H Gyorscsatlakozó
E Conexión de la entrada de aire



No.	Ø (mm)	
GV-1240	6	500/1500
GV-1241	8	500/2000
GV-1242	10	500/1500

PL Gwint stożkowy
GB Taper reducer
D Verlängerungsrippel
RUS Ниппель

CZ 9VAVNDVNAHREPE JI YMP
RO Reductie
H Kúpos menet
E Junta nypel rosca cónica



No.	size / rozmiar	
GV-1272	1/4" (6.3 mm)	100/2000

PL Złącze bagnetowe do węży
GB Bayonet coupling for rubber pipes
D Bajonettverschluss für gummischläuche
RUS Переходник „елочка на елочку”

CZ Spojky hadicové bajonetové
RO Conector tevi
H Bajonett csatlakozó tömlőhöz
E Junta de bayoneta para manguera de goma



No.	Ø (mm)	
GV-1582	8	100/800
GV-1583	10	600

PL Złącze króciec do węża
 GB Male hose adapter
 D Schauchtüle mit aussengewinde
 RUS Штуцер „елочка”

CZ Spojky – nátrubek pro hadici
 RO Adaptor furtun
 H Csatlakozó csőcsonk tömlőhöz
 E Junta tubo corto para manguera 6 rosca exter



No.	size / rozmiar	Ø (mm)	L (mm)	
GV-1382	1/4" (6.3 mm)	6	33	500/1500
GV-1384	1/4" (6.3 mm)	8	33	100/1000
GV-1385	3/8" (10.0 mm)	8	34	100/1000
GV-1386	3/8" (10.0 mm)	10	34	100/1200
GV-1387	1/2" (12.5 mm)	10	37	250/1000
GV-1388	1/4" (6.3 mm)	10	35	250/1000

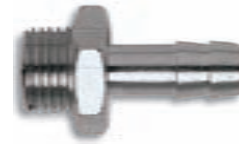

PL Filtr
 GB Filter
 D Filtr
 RUS Минифильтр

CZ Filtr
 RO Minifiltru
 H Szűrő
 E Filtro

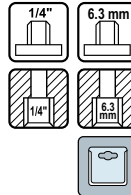

No.	size / rozmiar	
81560	1/4" (6.3 mm)	10/50

PL Reduktor ciśnienia z manometrem
 GB Pressure reducing valve with manometer
 D Druckminderer mit manometer
 RUS Клапан уменьшения давления с манометром

CZ Redukční ventil s manometrem
 RO Valva cu reductie presiune + manometru
 H Nyomáscsökkentő szelep nyomásmérővel
 E Reductor + manometro



No.	size / rozmiar	
81562	3/8" (10.0 mm)	50

PL Filtr - reduktor
 GB Filter - reducer
 D Druckfilter - druckminderer
 RUS Фильтр - редуктор

CZ Filtr derukční ventil
 RO Filtru cu reductor
 H Szűrő - nyomáscsökkentő
 E Reductor + filtro

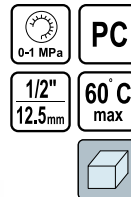

No.	size / rozmiar	
81553	1/2" (12.5 mm)	20

PL Zespół filtrujący, reduktor + smarownica
 GB Air filter regulator and lubricator
 D Druckfilter-druckminderer - Entöler
 RUS Фильтр-редуктор

CZ Redukční ventil s odlučovačem oleje
 RO Filtru cu reductor
 H Levegőelőkészítő
 E Juego de filtro reductor + engrasador

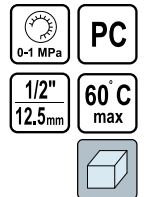

No.	size / rozmiar	
81556	1/2" (12.5 mm)	20

PL Wąż spiralny PE z szybkozłączami
 GB PE spiral tubes with rapid couplings
 D Spiralschlauch mit Schnellkupplung
 RUS Полиэтиленовый шланг

CZ Spirální hadice
 RO Furtun în spirală
 H Spiráltömlő
 E Manguera espiral



No.	mm	L (m)	
81490	5x8	5	50
81491	5x8	10	25
81492	5x8	15	25

PL Wąż spiralny PE z szybkozłączami
 GB PE spiral tubes with rapid couplings
 D Spiralschlauch mit Schnellkupplung
 RUS Полиэтиленовый шланг

CZ Spirální hadice
 RO Furtun în spirală
 H Spiráltömlő
 E Manguera espiral



No.	mm	L (m)	
81500	5x8	5	50
81501	5x8	10	25
81502	5x8	15	25

PL Wąż zbrojony
GB Armoured hose
D Schlauch, verstärkt durch Bewehrung
RUS Армированный шланг

CZ +DGFH V] W]H]O
RO Furtun armat
H Fémbeütetes tömlő
E Manguera armada



No.	Ø (mm)	L (m)	wall thickness / grubość ścianki	ATM	
81519	6	50	2.5	10/40	1
81520	8	50	2.5	10/40	1
81521	10	50	2.5	10/40	1
81522	12	50	2.5	10/40	1
81523	14	50	3.0	10/40	1
81524	16	50	3.0	10/40	1
81525	19	50	3.5	10/40	1
81527	25	50	4.0	10/40	1

PL Szybkozłącze
GB Quick coupler
D Schnellkupplung
RUS Быстрое соединение

CZ Rychlospojka
RO Mufa rapida pt. pistol pneumatic
H Gyorscsatlakozó
E Conexión de la entrada de aire



No.	type	size / rozmiar	
81370	D	1/4" (6.3 mm)	50/250
81371	D	3/8" (10.0 mm)	50/250
81372	D	1/2" (12.5 mm)	50/250

PL Szybkozłącze
GB Quick coupler
D Schnellkupplung
RUS Быстрое соединение

CZ Rychlospojka
RO Mufa rapida pt. pistol pneumatic
H Gyorscsatlakozó
E Conexión de la entrada de aire



No.	type	size / rozmiar	
81373	D	1/4" (6.3 mm)	50/250
81374	D	3/8" (10.0 mm)	50/250

PL Szybkozłącze
GB Quick coupler
D Schnellkupplung
RUS Быстрое соединение

CZ Rychlospojka
RO Mufa rapida pt. pistol pneumatic
H Gyorscsatlakozó
E Conexión de la entrada de aire



No.	type	size / rozmiar	
81378	D	1/4" (6.3 mm)	50/250
81379	D	3/8" (10.0 mm)	50/250
81380	D	1/2" (12.5 mm)	50/250

PL Szybkozłącze
GB Quick coupler
D Schnellkupplung
RUS Быстрое соединение

CZ Rychlospojka
RO Mufa rapida pt. pistol pneumatic
H Gyorscsatlakozó
E Conexión de la entrada de aire



No.	type	size / rozmiar	
81390	D	1/4" (6.3 mm)	50/250
81391	D	3/8" (10.0 mm)	50/250

PL Szybkozłącze
GB Quick coupler
D Schnellkupplung
RUS Быстрое соединение

CZ Rychlospojka
RO Mufa rapida pt. pistol pneumatic
H Gyorscsatlakozó
E Conexión de la entrada de aire



No.	type	size / rozmiar	
81387	D	1/4" (6.3 mm)	50/250

PL Szybkozłącze
GB Quick coupler
D Schnellkupplung
RUS Быстрое соединение

CZ Rychlospojka
RO Mufa rapida pt. pistol pneumatic
H Gyorscsatlakozó
E Conexión de la entrada de aire



No.	type	size / rozmiar	
81399	D	1/4" (6.3 mm)	50/250
81400	D	3/8" (10.0 mm)	50/250
81401	D	1/2" (12.5 mm)	50/250

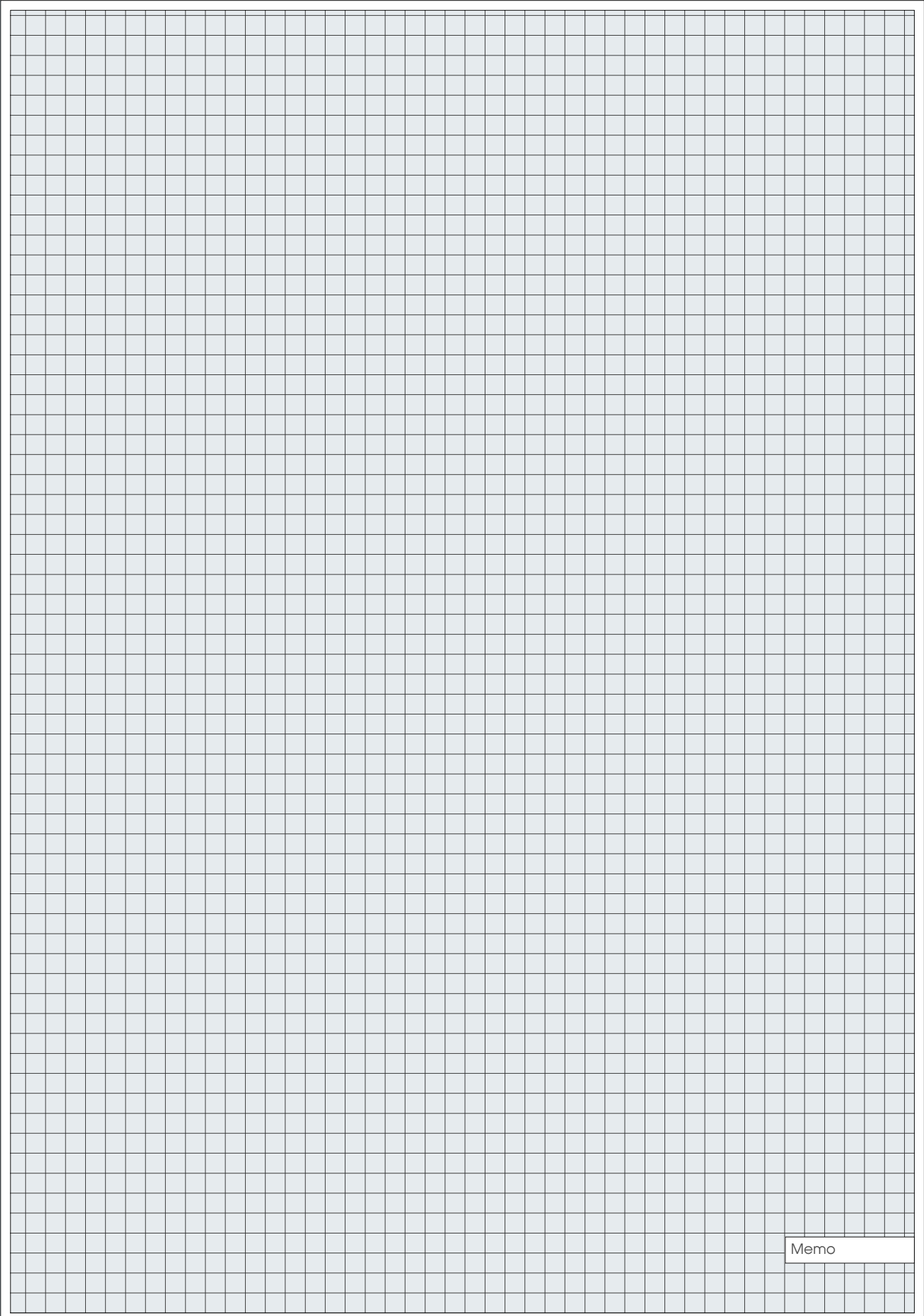

Memo

14

Special automotive tools & equipment **Narzędzia i wyposażenie warsztatu** **samochodowego**

Cabinets
Szafki



172

Roller cabinets with tools insert
Szafki serwisowe z narzędziami..... 172

Tool cabinets
Szafki serwisowe..... 172

Lubrication tools
Narzędzia do smarowania



172-175

Grease guns & oil transfer pumps
Smarownice ręczne i pompy transferowe do oleju..... 172

Manual oil pumps
Pompy ręczne do oleju..... 173

Oil cans
Oliwiarki..... 174

Oil filter wrenches
Klucze do filtra oleju..... 174

Pullers
Ściągacze

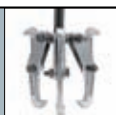

175-176

Gear pullers
Ściągacze do łożysk..... 175

Spring pullers
Ściągacze do sprężyn..... 176

Ball joint removers
Ściągacze do sworzni kulistych..... 176

Workshop tools
Narzędzia warsztatowe



176-183

Wheel wrenches
Klucze do kół..... 176

Piston ring compressors
Zaciskacze do pierścieni..... 177

Spark plug sockets
Klucze do świec..... 177

Flare nut wrenches
Klucze do przewodów hamulcowych..... 177

Car voltage testers
Samochodowe próbniki napięcia..... 177

Magnetic wrist bands
Opaski magnetyczne..... 178

Magnetic pick up tools
Chwytniki magnetyczne..... 178

Workshop seats
Taborety warsztatowe..... 178

Workshop creepers
Leżanki warsztatowe..... 179

Impact wrenches
Klucze udarowe..... 179

Workshop lamps
Lampy warsztatowe..... 179

Bottle & floor jacks
Dźwigniki słupkowe i podnośniki..... 180

Scissors jacks
Podnośniki mechaniczne..... 181

Jack stands
Podstawki pod samochód..... 181

Porta power kits
Rozpieraki hydrauliczne..... 182

Pull-back rams
Ściągacze blacharskie hydrauliczne..... 182

Battery chargers
Prostowniki..... 182

Tire pressure gauges
Mierniki ciśnienia..... 183

Chain blocks
Wciągarki łańcuchowe..... 183

Car accessories
Akcesoria samochodowe



183-189

Pumps
Pompki..... 183

Tow ropes
Linki holownicze..... 184

Battery clamp cleaners
Szczotki do czyszczenia klem..... 184

Battery hydrometers
Próbniki akumulatorowe..... 185

Booster cables
Wiązki przewodów awaryjnych..... 185

Scrapers & brushes
Skrabaczki i szczotki..... 185

Flexible funnels
Lejki..... 185

Fire extinguishers
Gaśnice samochodowe..... 186

First aid kits
Apteczki..... 186

Fuses
Bezpieczniki..... 187

Safety triangles
Trójkąty ostrzegawcze..... 187

Breathalyzers
Alkomaty..... 187

Ratchet tie downs
Taśmy do bagażu..... 187

Tarpaulins
Plandeki..... 189

- PL Szafka serwisowa z narzędziami
- GB Service tool cabinet with tools
- D Serviceschrank mit Werkzeugen
- RUS Сервисный шкаф с инструментами
- CZ Servisní skříňka s nářadím
- RO Cutie de service cu scule
- H Szerelészserény szerszámokkal
- E Armario para herramientas de servicio



177 PCS TRAY WKŁAD 12	770x458 x901mm	DRAWERS LOCKING BLOKADA SZUFLAD	CENTRAL LOCK CENTRALNY ZAMEK	2x	CORNER BUMPERS NARÓŻNE ODBOJNIKI
6x	WHEEL TOLKY	2x BRAKE HAMULCE	BALL BEARING ŁOŻYSKA KULKOWE	NON SLIP WORKTOP BLAT ANTYPADAJĄCY	UNIVERSAL PERFORATION UNIWERSALNA PERFORACJA



12 interchangeable trays with tools
12 wymiennych modułów z narzędziami

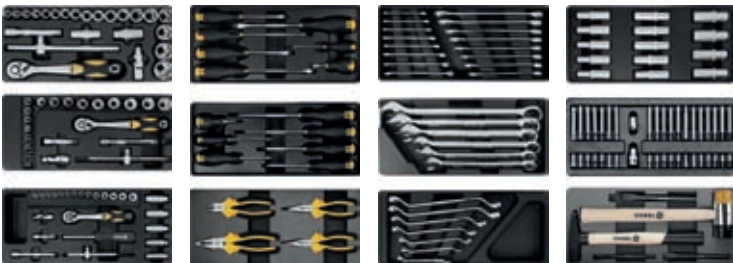

No.	drawers / szuflady	
58540	6	1

DRAWER / SZUFLADA 1

1/2" (12.7 mm): 10, 11, 12, 13, 14, 15, 16, 17, 18, 19, 20, 21, 22, 23, 24, 27, 30, 32 mm; CrV 50BV30; 1/2" (12.7 mm); (127 mm); CrV 50BV30; 1/2" (12.7 mm); CrV 50BV30; 1/2" (12.7 mm); (255 mm); 72T; CrV 6140; 1/2" (12.7 mm); (255 mm); CrV 50BV30; 1/2" (12.7 mm); 16; 21 mm; CrV 50BV30

3/8" (9.5 mm): 6, 7, 8, 9, 10, 11, 12, 13, 14, 15, 16, 17, 18, 19, 20, 21, 22 mm; CrV 50BV30; 3/8" (9.5 mm); (76, 152.4 mm); CrV 50BV30; 3/8" (9.5 mm); CrV 50BV30; 3/8" (9.5 mm); (200 mm); 72T; CrV 6140; 3/8" (9.5 mm); (198 mm); CrV 50BV30

1/4" (6.3 mm): 3.5, 4, 4.5, 5, 5.5, 6, 7, 8, 9, 10, 11, 12, 13, 14 mm; CrV 50BV30; 1/4" (6.3 mm); 8, 10, 11, 12, 13 mm; CrV 50BV30; 1/4" (6.3 mm); (50.8, 101.6 mm); CrV 6140; 1/4" (6.3 mm); CrV 50BV30; 1/4" (6.3 mm); (155 mm); 72T; CrV 6140; 1/4" (6.3 mm); (150 mm); CrV 50BV30; 1/4" (6.3 mm); (152.4 mm); CrV 50BV30

DRAWER / SZUFLADA 2

3x75 mm, 5x100 mm, 5x150 mm, 6x38 mm, 6x100 mm, 6x150 mm, 8x150 mm; CrV:

PH0x100 mm, PH1x75 mm, PH1x100 mm, PH2x38 mm, H2x100 mm, PH2x150 mm, PH3x150 mm; CrV:

180 mm; 160 mm; 160 mm BENT / WYGIĘTE

DRAWER / SZUFLADA 3

6x7, 8x9, 10x11, 12x13, 14x15, 16x17, 18x19 mm; 22, 24, 27, 28, 30, 32 mm; 6, 7, 8, 9, 10, 11, 12, 13, 14, 15, 16, 17, 18, 19, 20, 21 mm

DRAWER / SZUFLADA 4

1/2" (12.7 mm): 8, 9, 10, 11, 12, 13, 14, 15, 16, 17, 18, 19, 20, 21 mm (L=76 mm); CrV 50BV30;

1/2" (12.7 mm), 3/8" (9.5 mm); H4, H5, H6, H7, H8, H10, H12 (L=30 mm); H4, H5, H6, H7, H8, H10, H12 (L=75 mm); CrV; M5, M6, M7, M10, M12 (L=30 mm); M5, M6, M7, M10, M12 (L=75 mm); CrV; T20, T25, T30, T40, T45, T50, T55 (L=30 mm); T20, T25, T30, T40, T45, T50, T55 (L=75 mm); CrV;

300 g (L=300 mm); 40 mm (L=300 mm); 10x8x142 mm, 12x10x152 mm, 16x13x170 mm

- PL Szafka serwisowa
- GB Roller cabinet
- D Werkstattrollwagen
- RUS Инструментальный кабинет
- CZ Dílenská skříňka
- RO Dulap de scule
- H Görgös szerszámtároló
- E Armario en ruedas



No.	cm	drawers / szuflady
81830	61.5x33.5x74.5	6

- PL Smarownica
- GB Lever grease gun
- D Handhebel fettpresse
- RUS Ручной смазочный шприц
- CZ Maznice na smír
- RO Pistol de gresat-vaselina
- H Sirzó /tömlővel/
- E Engrasador

400ml



No.	ml
78040	400

- PL Smarownica
- GB Lever grease gun
- D Handhebel fettpresse
- RUS Ручной смазочный шприц
- CZ Maznice na smír
- RO Pistol de gresat-vaselina
- H Sirzó /tömlővel/
- E Engrasador

400 cm



No.	cm ³
78046	400

- PL Smarownica
- GB Lever grease gun
- D Handhebel fettpresse
- RUS Ручной смазочный шприц
- CZ Maznice na smír
- RO Pistol de gresat-vaselina
- H Sirzó /tömlővel/
- E Engrasador

400 cm

AI

P(MPa)
41-69



No.	cm ³
78041	400

Special automotive tools & equipment / Narzędzia i wyposażenie warsztatu samochodowego

PL Smarownica
GB Lever grease gun
D Handhebel Fettpresse
RUS Ручной смазочный шприц

CZ Maznice na šmír
RO Pistol de gresat-vaselina
H Sirző /tömlővel/
E Engrasador

400 cm³ AI
P(MPa) 41-69

VOREL

No.	cm ³	
78042	400	5/10

PL Towotnica
GB Lever grease gun
D Handhebel Fettpresse
RUS Ручной смазочный шприц

CZ Maznice na šmír
RO Pistol de gresat-vaselina
H Sirző /tömlővel/
E Engrasador

500 cm³

VOREL

No.	cm ³	
78047	500	10

PL Towotnica
GB Lever grease gun
D Hand-fettpresse
RUS Ручной смазочный шприц

CZ Maznice na šmír
RO Pistol de gresat cu tija rigidă
H Sirző /tömlővel/
E Engrasador

445 cm³

VOREL

No.	cm ³	
78050	445	15

PL Smarownica
GB Lever grease gun
D Handhebel Fettpresse
RUS Ручной смазочный шприц

CZ Maznice na šmír
RO Pistol de gresat-vaselina
H Sirző /tömlővel/
E Engrasador

600 cm³ AI
P(MPa) 41-69

VOREL

No.	cm ³	
78043	600	6/12

PL Wężyk do towotnicy
GB Flexible tube for grease gun
D Schlauch für Fettpresse
RUS Шланг для шприца

CZ Hadička na maznice na šmír
RO Furtun flexibil pt. pistol de gresat
H Tömlő a zsírszóhoz
E Manguera para engrasador

240 mm

VOREL

No.	L (mm)	
78045	240	50/250

PL Zestaw końcówek czteroczęściowych do smarownic
GB Heavy duty jaw couplers
D Mundstücksatz für Handhebel Fettpressen
RUS Соединительные патроны для масляного пистолета
CZ Sada koncovek k mazacímu lisu
RO Doza de legatura
H Tömlő csatlakozó karos zsírszóhoz
E Juego de boquillas para engrasadores

4 pcs 15 mm
6-7 mm G 1/8-28

VOREL

No.	Ø (mm)	pcs	
78061	15	4	20/80

PL Wężyk giętki do smarownic
GB Flexible hose for grease gun
D Schlauch für Fettpresse
RUS Гибкий шланг для товотницы
CZ Hadička na maznice na šmír
RO Furtun flexibil pt. pistol de gresat
H Tömlő a zsírszóhoz
E Manguera para engrasador

6-7 mm G 1/8-28
31MPa 4500 PSI

VOREL

No.	L (mm)	Mpa	
78067	300	31	50/250
78068	500	31	50/250

PL Pompa ręczna do oleju
GB Manual oil pump
D Öl-Umfüllpumpe
RUS Ручной насос для перекачки масел

CZ Pumpa ruční na olej
RO Pompa manuală apa ulei
H Kézi olajszivattyú
E Bomba manual para aceite

VOREL

No.	l / min	
78000	19	5

PL Odsysarka ręczna do oleju
GB Oil drainer
D Öl-Absaugpumpe
RUS Ручной шприц для откачки масла

CZ Ruční odsávačka oleje
RO Pompa de ulei
H Kézi olajszivattyú
E Bomba de succión manual para aceite

200 cm³ 



No.	cm ³	
78030	200	10

PL Odsysarka ręczna do oleju
GB Oil drainer
D Öl-Absaugpumpe
RUS Ручной шприц для откачки масла

CZ Ruční odsávačka oleje
RO Pompa de ulei
H Kézi olajszivattyú
E Bomba de succión manual para aceite

400 cm³ 



No.	cm ³	
78031	400	10

PL Odsysarka ręczna do oleju
GB Oil drainer
D Öl-Absaugpumpe
RUS Ручной шприц для откачки масла

CZ Ruční odsávačka oleje
RO Pompa de ulei
H Kézi olajszivattyú
E Bomba de succión manual para aceite

500 cm³ 



No.	cm ³	
78044	500	10/20

PL Pompa ręczna do oleju
GB Manual oil pump
D Öl-Umfüllpumpe
RUS Ручной насос для перекачки масел

CZ Pompa ruční na olej
RO Pompa manuala apa ulei
H Kézi olajszivattyú
E Bomba manual para aceite

500 cm³ 



No.	cm ³	
78035	500	10

PL Oliwiarka
GB Oil can
D Ölkanne
RUS Масленка

CZ Maznička
RO Pompiță de ulei
H Olajozó
E Acclera







No.	ml	
78300	300	15/60

PL Oliwiarka z wężkiem
GB Oil can with flexible hose
D Ölkanne mit flexiblem Aufsatz
RUS Масленка с гибким шлангом

CZ Olejova maznice
RO Cana ulei cu furtun flexibil
H Olajozó kanna, hajlékony tömlővel
E Acclera







No.	ml	
78306	200	10/60

PL Oliwiarka z końcówką sztywną
GB Oil can with rigid spout
D Ölkanne mit starrem Aufsatz
RUS Масленка с твердым наконечником

CZ Olejová maznice
RO Cana ulei cu furtun rigid
H Olajozó kanna, merev szárral
E Acclera







No.	ml	
78303	300	10/60

PL Klucz do filtra oleju
GB Oil filter wrench
D Ölfilterspinne
RUS Съёмник масляных фильтров

CZ Klíč na filtr oleju
RO Chele pt. filtru de ulei
H Olajszűrő kulcs
E Llave de filtro





No.	size / rozmiar	Ø (mm)	
57600	3/8" (10.0 mm)	65-110	6/36

Special automotive tools & equipment / Narzędzia i wyposażenie warsztatu samochodowego

PL Klucz do filtra oleju, zaciskowy
 GB Oil filter wrench
 D Ölfilterschlüssel
 RUS Съёмник масляных фильтров замковый

CZ Klíč na filtr oleju svěrací
 RO Cheie cu strângere pt. filtru de ulei
 H Olajszűrő kulcs, patintós
 E Llave de filtro de apriete



No.	Ø (mm)	
57610	55-110	25/50

PL Klucz do filtra oleju
 GB Oil filter wrench
 D Ölfilterspinne
 RUS Съёмник масляных фильтров

CZ Klíč na filtr oleju
 RO Cheie pt. filtru de ulei
 H Olajszűrő kulcs
 E Llave de filtro



No.	
57620	10/100

PL Klucz do filtra oleju
 GB Oil filter wrench
 D Ölfilterspinne
 RUS Съёмник масляных фильтров

CZ Klíč na filtr oleju
 RO Cheie pt. filtru de ulei
 H Olajszűrő kulcs
 E Llave de filtro



No.	
57630	10/40

PL Klucz do filtra oleju
 GB Oil filter wrench
 D Ölfilterspinne
 RUS Съёмник масляных фильтров

CZ Klíč na filtr oleju
 RO Cheie pt. filtru de ulei
 H Olajszűrő kulcs
 E Llave de filtro



No.	
57640	25/100

PL Klucz do filtra oleju
 GB Oil filter wrench
 D Ölfilterspinne
 RUS Съёмник масляных фильтров

CZ Klíč na filtr oleju
 RO Cheie pt. filtru de ulei
 H Olajszűrő kulcs
 E Llave de filtro



No.	
57650	24/72

PL Klucz do filtra oleju
 GB Oil filter wrench
 D Ölfilterschlüssel
 RUS Ключ к масляному фильтру

CZ Klíč na filtr oleju
 RO Cheie pt. filtru de ulei
 H Olajszűrő kulcs
 E Llave para el filtro de aceite



No.	Ø (mm)	
57612	73-85	12/48
57613	83-95	12/48
57614	93-111	12/48

PL Ściągacz do łożysk
 GB Gear puller
 D Dreiarmliger abzieher
 RUS Съёмник подшипников 3-х лапчатый
 CZ 6 VĚKRYM NCD ØALM
 RO Clește cu 3 brațe pt. extras rulmenți
 H Hidraulikus csapágyelhúzó
 E Extractor de cojinetes



No.	mm	arms / ramiona	
80500	75	3	4/40
80510	100	3	5/30
80520	150	3	2/20
80530	200	3	2/12

PL Ściągacz do łożysk
 GB Gear puller
 D Dreiarmliger abzieher
 RUS Съёмник подшипников 3-х лапчатый

CZ 6 VĚKRYM NCD ØALM
 RO Clește cu 3 brațe pt. extras rulmenți
 H Hidraulikus csapágyelhúzó
 E Extractor de cojinetes



No.	mm	arms / ramiona	
80534	0-120	3	2/6

PL Ściągacz do sprężyn
GB Coil spring clamp
D Federspanner
RUS Стяжка пружин

CZ 6MMRM NCD SUXAIC
RO Dispozitiv pt. demontat arcuri auto
H Rugóelhúzó
E Extractor de muelles

2
PCS



No.	pcs packing	box
80600	2	6/12

PL Ściągacz do sprężyn
GB Coil spring clamp
D Federspanner
RUS Стяжка пружин

CZ 6MMRM NCD SUXAIC
RO Dispozitiv pt. demontat arcuri auto
H Rugóelhúzó
E Extractor de muelles

2
PCS



No.	pcs packing	box
80601	2	10

PL Ściągacz do sworzni kulistych
GB Tie rod end lifter
D Universal-kugelgelenk-abzieher
RUS Съёмник шаровых опор

CZ Stahovák kulových čepů řízení
RO Extractor pt. articulatii sferice
H Gömbfej kinyomó
E Extractor pt. articulatii sferice



No.	box
80620	25/50

PL Ściągacz do sworzni kulistych
GB Tie rod end lifter
D Universal-kugelgelenk-abzieher
RUS Съёмник шаровых опор

CZ Stahovák kulových čepů řízení
RO Extractor pt. articulatii sferice
H Gömbfej kinyomó
E Extractor pt. articulatii sferice



No.	box
80640	25

PL Ściągacz bezwładnościowy do piast i łożysk
GB Slide hammer set
D Träge Abziehvorrichtung für Naben und Lager
RUS Инерционный съёмник ступиц и подшипников
CZ 5 l RYE 6MMRM NVNDI ČEP NDKYHP CD D ERN D ØBAIND
RO Set cloac culisant extractor de rulmenți și bucșe
H Csúszósúlyos kerékagy - és csapágyelhúzó készlet
E Extractor de inercia para cubos y cojinetes

13
PCS

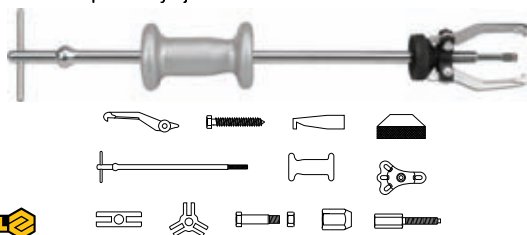

No.	pcs	box
80700	13	2

PL Krzyżakowy klucz do kół
GB Cross rim wrench
D Kreuzschlüssel
RUS Балонный ключ-крест

CZ Klíč na kola křáříře
RO Cheie în cruce pt. roți
H Kereszt kerékkulcs
E Llave cruz para ruedas



No.	mm / inch (cale)	box
57000	17x19x22x13/16" (20.6 mm)	20

PL Krzyżakowy klucz do kół
GB Cross rim wrench
D Kreuzschlüssel
RUS Балонный ключ-крест

CZ Klíč na kola křáříře
RO Cheie în cruce pt. roți
H Kereszt kerékkulcs
E Llave cruz para ruedas



No.	mm	box
57010	17x19x21x23	20

PL Krzyżakowy klucz do kół
GB Cross rim wrench
D Kreuzschlüssel
RUS Балонный ключ-крест

CZ Klíč na kola křáříře
RO Cheie în cruce pt. roți
H Kereszt kerékkulcs
E Llave cruz para ruedas



No.	mm / inch (cale)	box
57020	17x19x21x1/2" (12.7 mm)	10

PL Krzyżakowy klucz do kół
GB Cross rim wrench
D Kreuzschlüssel
RUS Балонный ключ-крест

CZ Klíč na kola křížarý
RO Chele în cruce pt. roți
H Kereszt kerékkulcs
E Llave cruz para ruedas



No.	mm	
57030	17x19x21x23	20

PL Krzyżakowy klucz do kół
GB Cross rim wrench
D Kreuzschlüssel
RUS Балонный ключ-крест

CZ Klíč na kola křížarý
RO Chele în cruce pt. roți
H Kereszt kerékkulcs
E Llave cruz para ruedas



No.	mm / inch (cale)	
57050	24x27x32x3/4" (19.0 mm)	10

PL Klucz do kół rozsuwany
GB L-type wheel wrench
D Radschlüssel
RUS Ключ баллонный телескопический L-типа

CZ Klíč na kola rozvirány
RO Chele pt. roți extensibilă
H Kerékkulcs, kihúzható
E Llave para ruedas extensible

360-510 mm 17-19 mm

1/2" 12,5mm



No.	mm	L (mm)	size / rozmiar	
57100	17/19	360-510	1/2" (12.5 mm)	10/20

PL Zaciskacz do pierścieni
GB Piston ring compressor
D Kolbenring-Spannband
RUS Зажим колец
CZ Světlá ODRŽAN
RO Clește pt. strâns inele
H Gyűrűbepattintó
E Pinza para anillos

AISI #304

65 Mn



No.	Ø (mm)	H (mm)	
80660	50-125	75	36
80661	75-175	100	36

PL Klucz do świece
GB Spark plug wrench
D Zündkerzenschlüssel
RUS Ключ свечной

CZ Svíčkový klíč
RO Chele pt. buji
H Gyertyakulcs
E Llave para bujías



No.	mm	L (mm)	
57160	16	150	25/50
57210	21	150	25/50

PL Klucz do świece
GB Spark plug wrench
D Zündkerzenschlüssel
RUS Ключ свечной

CZ Svíčkový klíč
RO Chele pt. buji
H Gyertyakulcs
E Llave para bujías



No.	mm	L (mm)	
57260	16/21	150	25/50

PL Klucze do przewodów hamulcowych
GB Flare nut wrenches
D Bremsleitungschlüsselsatz
RUS Набор ключей разрезных

CZ Klíče na vedení brzdý
RO Chele pt. conducte de frână
H Fékcsőkulcs
E Llaves para tubería de frenado

3 PCS



No.	pcs	
57700	3	12/60

PL Samochodowy próbnik napięcia
GB Car voltage tester
D Autospannungstester
RUS Пробник автомобильный

CZ Automobilový zkoušeč napětí
RO Creion de tensiune pt. automobile
H Autós fáziskereső
E Comprobador de corriente de coche



No.	V	
65260	6-24	20/200

PL Samochodowy próbnik napięcia
 GB Car voltage tester
 D Autospannungstester
 RUS Пробник автомобильный

CZ Automobilový zkoušeč napětí
 RO Creion de tensiune pt. automobile
 H Autós fáziskereső
 E Comprobador de corriente de coche



No.	V	
65270	6-24	20/200

PL Opaska magnetyczna
 GB Magnetic wrist band
 D Magnetisches Armband
 RUS Магнитные браслеты для хранения инструментов

CZ Nátepník magnetický
 RO Manseta magnetica
 H Mágneses csuklópánt
 E Brazalete magnético

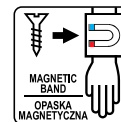

No.		
78755		10/40

PL Łapka do podnoszenia
 GB Pick-up tool
 D Starer Greifer
 RUS Гибкий захват „Pick-up”

CZ Patka pro zdvihání
 RO Surubelnita flexibilă
 H Emelőlapka
 E Grifo para recoger pick up



No.	L (mm)	
78400	600	50/150

PL Łapka magnetyczna, giętka
 GB Flexible pick-up handle, magnetic
 D Magnetisch flexibler greifer
 RUS Гибкий магнитный захват

CZ Vytahovák magnetický ohebný
 RO Surubelnita flexibilă magnetica
 H Mágneses felszedő eszköz, hajlékony nyel
 E Grifo magnetico flexible



No.	L (mm)	
78401	530	50/100

PL Łapka magnetyczna, teleskopowa
 GB Pick-up handle, magnetic
 D Magnetisch greifer
 RUS Магнитный захват

CZ Vytahovák magnetický teleskopický
 RO Surubelnita telescopica cu magnet
 H Mágneses felszedő eszköz, teleszkópos nyel
 E Grifo magnetico



No.	L (mm)	
78402	630	25/100

PL Taboret warsztatowy
 GB Workshop seat
 D Werkstattthocker
 RUS Табурет рабочий

CZ Dílenský taburet
 RO Taburet atelier
 H Műhely zsámoly
 E Taburete de taller



No.	max (kg)	
81823	90	4

PL Taboret warsztatowy z szufladą
 GB Workshop seat with drawer
 D Werkstattthocker mit Schublade
 RUS Табурет рабочий с ящиком

CZ Dílenský taburet se zásuvkou
 RO Taburet atelier cu sertar
 H Műhely zsámoly fiókkal
 E Taburete de taller con cajón



No.	max (kg)	
81824	90	4

PL Taboret warsztatowy teleskopowy
 GB Pneumatic car seat
 D Werkstattthocker, teleskopisch
 RUS Табурет рабочий подъемный

CZ Dílenský taburet teleskopický
 RO Taburet atelier telescopic
 H Teleszkópos műhely zsámoly
 E Taburete de taller telescópico



No.	max (kg)	
81825	135	4

PL Leżanka warsztatowa na kółkach
 GB Workshop creeper
 D Werkstattliegewagen auf Rädern
 RUS Лежак ремонтный

CZ / HQ WRP ROMQ CD NRQKčák
 RO Targa auto mobilă
 H Fekpad gurulós
 E Camilla de taller con ruedas



VOREL

No.	mm	
81820	930x440x105	1

PL Elektryczny klucz udarowy
 GB Electric impact wrench
 D Elektro-Schlagschrauber
 RUS Электрический гайковерт
 CZ Elektrický rázový uťahovák
 RO Chele electrică
 H Elektromos ütvecsavarozó
 E llave de impacto eléctrica

230V~50Hz
 800 W
 2200 min⁻¹
 325 Nm
 1/2" 12.5 mm
 17, 19, 21, 22 mm



STHOR

L_{WA} = 87,5 ± 3,0 dB;
 L_{WA} = 98,5 ± 3,0 dB;
 a_w = 9,93 ± 1,5 m/s²

No.	W	min-1	
57091	800	2200	5

PL Lampa neonowa
 GB Working light
 D Werksatatlampe
 RUS Лампа-переноска, люминесцентная

CZ Neonová lampa
 RO Lampa neon
 H Neonlámpa
 E Lampara de neón

230V



No.	W	type	
82701	8	„ELECTRONIC“	20

PL Lampa neonowa
 GB Working light
 D Werksatatlampe
 RUS Лампа-переноска, люминесцентная

CZ Neonová lampa
 RO Lampa neon
 H Neonlámpa
 E Lampara de neón

230V



No.	W	type	
82703	8	„PROFI“	6

PL Lampa warsztatowa
 GB Working light
 D Werksatatlampe
 RUS Лампа-переноска

CZ Pracovní lampa
 RO Lampă pt. atelier
 H Szerelőlámpa
 E Lampara de taller

230V



No.	W	type	
82705	11	„EFFECT“	10

PL Lampa warsztatowa
 GB Working light
 D Werksatatlampe
 RUS Лампа-переноска

CZ Pracovní lampa
 RO Lampă pt. atelier
 H Szerelőlámpa
 E Lampara de taller

230V



No.	W	type	
82712	60	„BASKET“	10

PL Lampa warsztatowa
 GB Working light
 D Werksatatlampe
 RUS Лампа-переноска

CZ Pracovní lampa
 RO Lampă pt. atelier
 H Szerelőlámpa
 E Lampara de taller

230V



No.	W	type	
82713	100	„PRACTIC“	10

PL Lampa warsztatowa
 GB Working light
 D Werksatatlampe
 RUS Лампа-переноска

CZ Pracovní lampa
 RO Lampă pt. atelier
 H Szerelőlámpa
 E Lampara de taller

230V



No.	W	type	
82714	60	„CLASSIC“	10

PL Lampa warsztatowa
GB Working light
D Werkstattlampe
RUS Лампа-переноска

CZ Pracovní lampa
RO Lampă pt. atelier
H Szereklámpa
E Lampara de taller

230V



No.	W	type	
82716	60	„GUMMI“	10
82717	100	„GUMMI“	10

PL Lampa warsztatowa
GB Working light
D Werkstattlampe
RUS Лампа-переноска

CZ Pracovní lampa
RO Lampă pt. atelier
H Szereklámpa
E Lampara de taller

230V



No.	W	type	
82715	60	„PLASTIC“	10

PL Diodowa lampa bezprzewodowa
GB Rechargeable work lamp
D Led werkstattlampe
RUS Светодиодная беспроводная лампа

CZ 0 ROM/0 QP SD GER/RY EH Sřivodová
RO Lampa cu led fara cablu
H Ledlámpa
E Lámpara inalámbrica de diodos

230V/50Hz
BATTERY CHARGER
LADOWARKA

36 LED

12V

500 mAh

MAGNETIC

HOOK



No.	LED	mAh	
82720	36	500	10/20

PL Diodowa lampa bezprzewodowa
GB Rechargeable work lamp
D Led werkstattlampe
RUS Светодиодная беспроводная лампа

CZ 0 ROM/0 QP SD GER/RY EH Sřivodová
RO Lampa cu led fara cablu
H Ledlámpa
E Lámpara inalámbrica de diodos

27 LED

12V

NIMH 500 mAh

SHOCKPROOF

OILRPROOF

230V/50Hz
BATTERY CHARGER
LADOWARKA

HOOK

WATERPROOF



No.	LED	mAh	
82721	27	500	10/20

PL Diodowa lampa bezprzewodowa
GB Rechargeable work lamp
D Led werkstattlampe
RUS Светодиодная беспроводная лампа

CZ 0 ROM/0 QP SD GER/RY EH Sřivodová
RO Lampa cu led fara cablu
H Ledlámpa
E Lámpara inalámbrica de diodos

230V/50Hz
BATTERY CHARGER
LADOWARKA



No.	LED	mAh	type	
82725	27	1700	„JOKER“	10

PL Diodowa lampa bezprzewodowa
GB Rechargeable work lamp
D Led werkstattlampe
RUS Светодиодная беспроводная лампа

CZ 0 ROM/0 QP SD GER/RY EH Sřivodová
RO Lampa cu led fara cablu
H Ledlámpa
E Lámpara inalámbrica de diodos

60+17 LED

12V

500 mAh

230V/50Hz
BATTERY CHARGER
LADOWARKA

HOOK

SHOCKPROOF

OILPROOF

WATERPROOF



No.	LED	mAh	
82722	60+17	500	10/20

PL Podnośnik hydrauliczny sętkowy
GB Hydraulic bottle jack
D Hydraulischen Wagenheber
RUS Домкрат гидравлический „Бутылочный“
CZ Pístový zvedák hydraulický
RO Cric hidraulic cu piston
H Hidraulikus emelő
E Gato de embolo hidr.



No.	max t	↑ mm	kg	packing	
80010	2	181-345	2.4		6
80011	2	181-345	2.4		6
80020	3	194-372	3.1		6
80030	5	216-413	4.2		4
80040	8	230-457	5.3		4
80050	10	230-460	6.2		4
80060	12	230-465	6.9		3
80070	15	230-465	8.0		2
80080	20	242-452	10.5		2

PL Dźwignik tłokowy hydrauliczny
GB Hydraulic floor jack
D Hydraulischer Rangierwagenheber
RUS Домкрат гидравлический подкатной

CZ Pístový zvedák hydraulický – pracovní
RO Cric hidraulic cu piston pt. atelier
H Hidraulikus emelő – szervíz
E Gato de embolo hidr.rana

2t



VOREL

No.	max t	↑ mm	📦
80110	2	130-342	1

PL Dźwignik tłokowy hydrauliczny
GB Hydraulic floor jack
D Hydraulischer Rangierwagenheber
RUS Домкрат гидравлический подкатной

CZ Pístový zvedák hydraulický – pracovní
RO Cric hidraulic cu piston pt. atelier
H Hidraulikus emelő – szervíz
E Gato de embolo hidr.rana

2t



VOREL

No.	max t	↑ mm	📦
80121	2	130-350	1

PL Dźwignik tłokowy hydrauliczny
GB Hydraulic floor jack
D Hydraulischer Rangierwagenheber
RUS Домкрат гидравлический подкатной

CZ Pístový zvedák hydraulický – pracovní
RO Cric hidraulic cu piston pt. atelier
H Hidraulikus emelő – szervíz
E Gato de embolo hidr.rana

2t



VOREL

No.	max t	↑ mm	📦
80120	2	130-350	1

PL Dźwignik tłokowy hydrauliczny
GB Hydraulic floor jack
D Hydraulischer Rangierwagenheber
RUS Домкрат гидравлический подкатной

CZ Pístový zvedák hydraulický – pracovní
RO Cric hidraulic cu piston pt. atelier
H Hidraulikus emelő – szervíz
E Gato de embolo hidr.rana

3t



VOREL

No.	max t	↑ mm	📦
80232	3	145-490	1

PL Podnośnik mechaniczny trapezowy
GB Scissors jack
D Trapezwagenheber
RUS Домкрат механический ромбовый

CZ Lichoběžáková [YH3 N]
RO Cric mecanic
H Trapézemelő
E Gato mecanico-trapezoidal



VOREL

No.	t	↑ mm	📦
80252	1.5	95-390	5

PL Podnośnik mechaniczny trapezowy
GB Scissors jack
D Trapezwagenheber
RUS Домкрат механический ромбовый

CZ Lichoběžáková [YH3 N]
RO Cric mecanic
H Trapézemelő
E Gato mecanico-trapezoidal



No.	t	mm	📦
80271	1.2	380	4

PL Podstawka pod samochód
GB Jack stands
D Unterstellbock
RUS Подставка для автомобиля
CZ Podstavec pod auto
RO Chituc de metal
H Gépkocsi alátét
E Apoyos de coche

2t



No.	t	L (mm)	📦
80300	2	380	5

PL Podstawka pod samochód
GB Jack stands
D Unterstellbock
RUS Подставка для автомобиля
CZ Podstavec pod auto
RO Chituc de metal
H Gépkocsi alátét
E Apoyos de coche



VOREL

No.	t	↑ mm	pcs. packing	📦
80302	2	275-385	2	1
80303	3	280-420	2	1
80306	6	385-600	2	1

- PL Podstawa pod samochód
- GB Jack stands
- D Unterstellbock
- RUS Подставка для автомобиля
- CZ Podstavec pod auto
- RO Chituc de metal
- H Gépkocsi alátét
- E Apoyos de coche



2t



No.	t	↑ mm	PCS packing	
80312	2	280-370	2	5

- PL Rozpierek hydrauliczny
- GB Porta power repair kit
- D Hydraulischer richt und ausbeulsatz
- RUS Гидравлическая распорная стойка в наборе
- CZ Hydraulický rozpěrák
- RO Trusa pompa hidraulica + accesorii
- H Hidraulikus bontó
- E Cilindro de freno



4t



No.	t	
80402	4	1

- PL Rozpierek hydrauliczny
- GB Porta power repair kit
- D Hydraulischer richt und ausbeulsatz
- RUS Гидравлическая распорная стойка в наборе
- CZ Hydraulický rozpěrák
- RO Trusa pompa hidraulica + accesorii
- H Hidraulikus bontó
- E Cilindro de freno



10t



No.	t	
80410	10	1

- PL Rozpierek hydrauliczny
- GB Porta power repair kit
- D Hydraulischer richt und ausbeulsatz
- RUS Гидравлическая распорная стойка в наборе
- CZ Hydraulický rozpěrák
- RO Trusa pompa hidraulica + accesorii
- H Hidraulikus bontó
- E Cilindro de freno

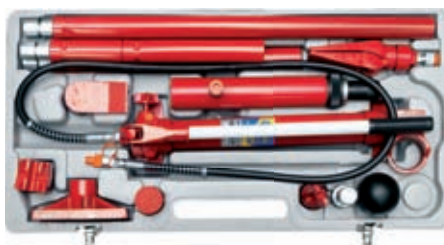

10t



No.	t	
80412	10	1

- PL Pompa do rozpiera hydraulicznego
- GB Accessories for porta power
- D Druckeinheit für Hydr. Spreizer
- RUS Ручной насос для гидравлической распорной стойки
- CZ Pumpa na hydraulický rozpěrák
- RO Pompa hidraulica
- H Szivattyú hidraulikus bontóhoz
- E Bomba para cilindro de freno



No.	t	
80320	4	2
80330	10	2

- PL Ściągacz blacharski hydrauliczny
- GB Pull - back ram
- D Hydraulische Zugsylindereinheit
- RUS Гидравлическая стяжка-крюк
- CZ Klempířské stahovadlo hydraulické
- RO Carlig hidraulic tractare
- H Hidraulikus lemezkihúzó
- E Extractor de latonería de fontanero

10t **55 MPa**



No.	t	MPa	
80450	10	55	4

- PL Siłownik do rozpiera hydraulicznego
- GB Accessories for porta power
- D Kraftzylinder für Hydr. Spreizer
- RUS Сервомотор для гидравлической распорной стойки
- CZ Servomotor na hydraulický rozpěrák
- RO Accesorii pompa hidraulica
- H Erőátvitel a hidraulikus bontóhoz
- E Servo 4t para cilindro de freno



No.	t	
80340	4	4
80350	10	4

- PL Prostownik
- GB Rectifier
- D Batterieladegerät
- RUS Зарядное устройство
- CZ Usměřňovač
- RO Redresor
- H Akkumulátortöltő
- E Rectificador



230V~50Hz

WET MOKRY



No.	V	A	Ah	
82550	12	2.8	8-56	10
82551	12	4.2	12-84	10

- PL Prostownik
- GB Rectifier
- D Batterieladegerät
- RUS Зарядное устройство
- CZ Usměrňovač
- RO Redresor
- H Akkumulátortöltő
- E Rectificador



230V~
50Hz

WET
MOKRY



No.	V	A	Ah	
82552	6 / 12	5.8	12-116	5
82553	6 / 12	10.3	26-206	5

- PL Ciśnieniomierz samochodowy
- GB Tire pressure gauge
- D Reifendruckprüfer
- RUS Шинный манометр

- CZ Automobilový tlakoměr
- RO Manometru
- H Gépkocsi nyomásmérő
- E Manómetro de coche



No.	kg / cm ²	
82610	0.5-7.5	25/150

- PL Ciśnieniomierz samochodowy
- GB Tire pressure gauge
- D Reifendruckprüfer
- RUS Шинный манометр

- CZ Automobilový tlakoměr
- RO Manometru
- H Gépkocsi nyomásmérő
- E Manómetro de coche



No.	Mpa	
82611	0.05-0.3	10

- PL Ciśnieniomierz do aut ciężarowych
- GB Dual foot tire gauge
- D Reifendruckprüfer
- RUS Шинный манометр для грузовых машин

- CZ Tlakoměr na nákladní auta
- RO Indicator de presiune pt. camioane
- H Nyomásmérő tehergépkocsikhoz
- E Manómetro de caomones



No.	kg / cm ²	
82650	0.5-7.5	10/100

- PL Wyciągarka łańcuchowa
- GB Chain block
- D Kettenzug flaschenzug
- RUS Таль цепная
- CZ Zvedák řetězový
- RO Scripete cu lant
- H Láncos csigaszor emelő
- E Cabria de cadena



3m



No.	kg	chain / łańcuch (m)	
80751	1000	3	1
80752	2000	3	1
80753	3000	3	1

- PL Pompka nożna z manometrem
- GB Foot pump with manometer
- D Fussluftpumpe mit manometer
- RUS Насос ножной с манометром

- CZ 1 R&Q SXP-SD | P DCRP HMP
- RO Pompă de picior cu manometru
- H Lábpumpa nyomásmérővel
- E Bomba de piciora con manometro



No.	
82000	20

- PL Pompka tłokowa nożna
- GB Foot pump
- D Fussluftpumpe mit manometer
- RUS Насос ножной с манометром

- CZ 1 R&Q SXP-SD | P DCRP HMP
- RO Pompă de picior
- H Lábpumpa nyomásmérővel
- E Bomba de piciora con manometro



No.	MPa	
82005	0.7	5

- PL Pompka słupkowa ręczna
- GB Hand pump
- D Hand-Luftpumpe
- RUS Насос ручной
- CZ Hustilka ruční
- RO Pompă de mână cu manometru
- H Kézi pumpa
- E Bomba de barrote de mano



No.	MPa	
82020	0.3	20

- PL Pompka słupkowa z manometrem
- GB Hand pump with manometer
- D Hand-Luftpumpe mit Manometer
- RUS Насос ручной с манометром
- CZ Pumpa z manometrem
- RO Pompa de mana cu manometru
- H Kézi pumpa manométerrel
- E Bomba de barrote con manometro



No.	MPa	
82021	1	10

- PL Linka holownicza
- GB Tow rope
- D Abschleppseil
- RUS Трос автомобильный буксировочный
- CZ 7l aČe SURM J HN
- RO Șufă pt. remorcare
- H Vonatökötél
- E Cable de remorque



No.	kg	
82201	1500	20
82205	2500	10
82200	3000	12

- PL Linka holownicza
- GB Tow rope
- D Abschleppseil
- RUS Трос автомобильный буксировочный
- CZ 7l aČe SURM J HN
- RO Șufă pt. remorcare
- H Vonatökötél
- E Cable de remorque



No.	kg	
82206	3000	12
82207	4000	10

- PL Linka holownicza
- GB Tow rope
- D Abschleppseil
- RUS Трос автомобильный буксировочный
- CZ 7l aČe SURM J HN
- RO Șufă pt. remorcare
- H Vonatökötél
- E Cable de remorque



No.	kg	
82210	1500	20
82225	2500	20

- PL Linka holownicza z szeklą
- GB Tow rope
- D Abschleppseil
- RUS Трос автомобильный буксировочный
- CZ 7l aČe SURM J HN
- RO Șufă pt. remorcare
- H Vonatökötél
- E Cable de remorque



No.	kg	
82232	2500	16
82234	3500	12

- PL Linka holownicza z haklem
- GB Tow rope
- D Abschleppseil
- RUS Трос автомобильный буксировочный
- CZ 7l aČe SURM J HN
- RO Șufă pt. remorcare
- H Vonatökötél
- E Cable de remorque



No.	kg	
82231	1500	20
82233	2500	16

- PL Szczotka do czyszczenia klemm
- GB Battery clamps cleaner
- D Klemmbürste
- RUS Щетка для зачистки клемм
- CZ Kartáč pro čištění svorek
- RO Perie curatat borne auto
- H Akkumulátorsaru tisztító kefe
- E Cepillo para limpiar bornes



No.	
82440	10/160

- PL Szczotka do czyszczenia klemm
- GB Battery clamps cleaner
- D Klemmbürste
- RUS Щетка для зачистки клемм
- CZ Kartáč pro čištění svorek
- RO Perie curatat borne auto
- H Akkumulátorsaru tisztító kefe
- E Cepillo para limpiar bornes



No.	
82445	10/100

PL Komplet klem do akumulatora
GB Battery clamps
D Aku-polklemmen
RUS Клеммы аккумуляторные

CZ Sada svorek na akumulátor
RO Set de cleme pt. acumulator
H Akkumulátorsaru készlet
E Juego de bornes para acumulador

2
PCS

BRASS
MOSIADZ



No.	pcs packing	📦
82431	2	12

PL Próbnik akumulatorowy
GB Battery hydrometer
D Batteriesäureprüfer
RUS Ареометр аккумуляторный

CZ Akumulátorový zkoušeč
RO Instrument de verificare acumulator
H Akkumulátorpróbaó
E Probador de acumulador



No.	📦
82520	10/100

PL Wiązka przewodów awaryjnych
GB Boosters cables
D Starthilfekabel
RUS Старт-кабель
CZ Spouštěcí kabele
RO Cabluri de alimentare
H Indfókábel
E Pinzas de arranque



No.	A	📦
82501	120	6
82502	200	14
82504	400	6
82506	600	6

PL Skrobaczka do szyb
GB Car window scraper
D Auto-Eiskratzer
RUS Автомобильный скребок

CZ Škrabka na okna
RO Razultor gheata
H Jégkaparó
E Rascadora para cristales



No.	📦
82910	100

PL Szczotka do samochodu
GB Eureka duster
D Waschbürste
RUS Щетка-моп для мытья машин

CZ Kartač na auto
RO Perie pt. mașină
H Autómosó kefe
E Cepillo de coche



No.	📦
82939	25/50

PL Guma do szyb z drewnianą rączką
GB Window squeegee
D Scheibenreinger-holzstiel
RUS Стеклоочиститель с резинкой

CZ Guma do skel z dřevěnou rukojetí
RO Lamă-ștergător cu miner de lemn pt. geamuri
H Vízlehúzó gumi fa nyéllel
E Goma para cristales con mango de madera



No.	📦
82920	50

PL Lejek
GB Flexible funnel
D Trichter
RUS Воронка гибкая

CZ Nálevka
RO Pálnie
H Kétrészes tölcsér
E Embudo



No.	📦
83000	40

PL Lejek
GB Flexible funnel
D Trichter
RUS Воронка гибкая

CZ Nálevka
RO Pálnie
H Kétrészes tölcsér
E Embudo



No.	📦
83001	50

PL Lejek
 GB Flexible funnel
 D Trichter
 RUS Воронка гибкая

CZ Nálévka
 RO Pálnie
 H Kétrészes tölcser
 E Embudo



VOREL

No.		
83002		30

PL Lejek
 GB Funnel
 D Trichter
 RUS Воронка

CZ Nálévka
 RO Pálnie
 H Kétrészes tölcser
 E Embudo

4 PCS PP



VOREL

No.	pcs	diameter / średnica (mm)	height / wysokość (mm)	
83005	4	52; 76; 100; 120	75; 110; 125; 152	30

PL Gaśnica samochodowa
 GB Powder fire extinguisher
 D Pulverlöcher
 RUS Огнетушитель порошковый автомобильный

CZ Hasičí přístroj praškový
 RO Extinctor cu pudra
 H Porralító akasztóval
 E Extintor de polvo bc con soporte



VOREL

No.	kg	
83270	1	10

PL Apteczka samochodowa
 GB First aid kit
 D Verbandkasten
 RUS Аптечка автомобильная

CZ Příruční lékárnička první pomocy
 RO Trusă medicală de prim-ajutor
 H Elsősegély doboz
 E Botiquín



VOREL

No.	type	
83260	E-01	10

PL Apteczka samochodowa
 GB First aid kit
 D Verbandkasten
 RUS Аптечка автомобильная

CZ Příruční lékárnička první pomocy
 RO Trusă medicală de prim-ajutor
 H Elsősegély doboz
 E Botiquín



VOREL

No.	type	
83261	E-04	5

PL Apteczka samochodowa
 GB First aid kit
 D Verbandkasten
 RUS Аптечка автомобильная

CZ Příruční lékárnička první pomocy
 RO Trusă medicală de prim-ajutor
 H Elsősegély doboz
 E Botiquín



VOREL

No.	type	
83262	E-03	5

PL Apteczka metalowa
 GB Metal first aid kit
 D Apotheke aus Metall
 RUS Металлическая аптечка

CZ Kovová lékárnička
 RO Trusă medicală din metal
 H Fém elsősegély doboz
 E Botiquín de metal



VOREL

No.	type	dimensions / wymiary (mm)	
83266	E240	240x220x120	1

PL Apteczka metalowa
 GB Metal first aid kit
 D Apotheke aus Metall
 RUS Металлическая аптечка

CZ Kovová lékárnička
 RO Trusă medicală din metal
 H Fém elsősegély doboz
 E Botiquín de metal



VOREL

No.	type	dimensions / wymiary (mm)	
83267	E300	300x220x120	1

Special automotive tools & equipment / Narzędzia i wyposażenie warsztatu samochodowego

PL Bezpieczniki płytkowe
GB Plate fuses
D Flachsteck-sicherungen
RUS Набор плоских предохранителей

CZ Destičkové pojistky
RO Siguranțe de placă
H Lapos biztosíték
E Fusibles cilíndricos

10
PCS



No.	pcs. packing	
83465	10	100

PL Bezpieczniki płytkowe
GB Plate fuses
D Flachsteck-sicherungen
RUS Набор плоских предохранителей

CZ Destičkové pojistky
RO Siguranțe de placă
H Lapos biztosíték
E Fusibles cilíndricos

10
PCS



No.	pcs. packing	
83463	10	100

PL Trójkąt ostrzegawczy
GB Vehicle safety triangle
D Warndreieck
RUS Предупреждающий треугольник

CZ 90°VARNICE VARNIKOVIN
RO Triunghi de avertizare
H Elakadásjelző háromszög
E Triángulo de emergencia



No.	
83280	40

PL Alkomat jednorazowy
GB Disposable breathalyzer
D Alkoholtester
RUS Алкотестер

CZ Alkohol tester
RO Alcoolmetru
H Alkoholsonda
E Alcoholimetro



No.	
83710	25

PL Spinacz bagażu
GB Elastic tie down
D Gepäckspinnensatz
RUS Стяжка для багажа-8 крючков

CZ Elastické spinatka
RO Cordelina elastica
H Csomaggrógzítők pök
E Pulpo 8-ramion



No.	L (cm)	Ø (mm)	arms / ramiona	
82300	80	8	8	25/50



No.	L (cm)	Ø (mm)	arms / ramiona	
82301	80	8	8	25/50

PL Ściągacze elastyczne
GB Elastic straps
D Gummispannsell
RUS Стяжка для багажа

CZ Elastické spinatka
RO Cordelina elastica
H Rugalmas feszítő
E Pulpos

2
PCS



No.	L (cm)	Ø (mm)	pcs. packing	
82308	80	8	2	20/80
82310	100	8	2	20/80
82315	150	8	2	20/80
82320	200	8	2	20/80

PL Ściągacze elastyczne
GB Elastic straps
D Gummispannsell
RUS Стяжка для багажа

CZ Elastické spinatka
RO Cordelina elastica
H Rugalmas feszítő
E Pulpos

2
PCS

120
cm



No.	L (cm)	Ø (mm)	pcs. packing	
82305	120	12	2	12/24

PL Płaskie ściągacze elastyczne
GB Elastic straps
D Gummispannsell
RUS Стяжка для багажа

CZ Elastické spinatka
RO Cordelina elastica
H Rugalmas feszítő
E Pulpos

2
PCS



No.	L (cm)	pcs. packing	
82360	80	2	25/50
82370	100	2	25/50

- PL Zestaw linek z szeklą do bagażu
- GB Loop and lock set
- D Seil mit Schäkkel für Gepäck, Satz
- RUS Набор канатов со скобами для багажа
- CZ Souprava uplnačů zavazadel s karabinami
- RO Set de cordoane cu cârlige pt. bagaj
- H Gumpipok
- E Juego de cuerdas con mosquetón para el equipaje

2 pcs **86**cm
 ∅ 9,5mm

POLY-ETHYLENE
 POLETYLEN

AI
 75mm



No.	L (cm)	pcs	Icon
82304	86	2	12/48

- PL Taśma do bagażu ze sprzączką
- GB Ratchet tie down
- D Spanngurt
- RUS Ремни для крепления груза с зажимом фиксатором
- CZ Pásy na zavazadla
- RO Cordelina pt. bagaje cu clicheț
- H Csomagörgzítő pánt
- E Cintas para equipaje

2 PCS **2.5m**



No.	L (cm)	W (mm)	pcs packing	Icon
82331	250	25	2	10/80

- PL Taśma do bagażu ze sprzączką
- GB Ratchet tie down
- D Spanngurt
- RUS Ремни для крепления груза с зажимом фиксатором
- CZ Pásy na zavazadla
- RO Cordelina pt. bagaje cu clicheț
- H Csomagörgzítő pánt
- E Cintas para equipaje

5m



No.	L (m)	W (mm)	Icon
82341	5	25	12/48

- PL Taśma do bagażu
- GB Ratchet tie down
- D Spanngurt
- RUS Ремень для крепления багажа с трещоткой
- CZ Pás na zavazadla z napínáním
- RO Cordelina pt. bagaje cu clicheț
- H Csomagörgzítő pánt feszítővel
- E Cinta para equipaje con carraca



No.	L (m)	daN	W (mm)	Icon
82377	2	1000	35	10
82378	4	1000	35	10
82379	6	1000	35	10
82380	8	1000	35	10

- PL Taśma do bagażu
- GB Ratchet tie down
- D Spanngurt
- RUS Ремень для крепления багажа с трещоткой
- CZ Pás na zavazadla z napínáním
- RO Cordelina pt. bagaje cu clicheț
- H Csomagörgzítő pánt feszítővel
- E Cinta para equipaje con carraca

5m



No.	L (m)	W (mm)	Icon
82351	5	25	12/48

- PL Taśma do bagażu
- GB Ratchet tie down
- D Spanngurt
- RUS Ремень для крепления багажа с трещоткой
- CZ Pás na zavazadla z napínáním
- RO Cordelina pt. bagaje cu clicheț
- H Csomagörgzítő pánt feszítővel
- E Cinta para equipaje con carraca

2 PCS **5m**



No.	L (m)	W (mm)	pcs packing	Icon
82400	5	25	2	8/16

- PL Taśma do bagażu
- GB Ratchet tie down
- D Spanngurt
- RUS Ремень для крепления багажа с трещоткой
- CZ Pás na zavazadla z napínáním
- RO Cordelina pt. bagaje cu clicheț
- H Csomagörgzítő pánt feszítővel
- E Cinta para equipaje con carraca



No.	L (m)	daN	W (mm)	Icon
82372	4	1600	50	8
82373	6	1600	50	7
82374	8	1600	50	6
82375	10	1600	50	5
82384	6	2000	50	6
82386	8	2000	50	6
82388	10	2000	50	5
82390	12	2000	50	5



PL Taśma do bagażu
GB Ratchet tie down
D Spanngurt
RUS Ремень для крепления багажа с трещоткой

CZ Pás na zavazadla z napínáním
RO Cordelina pt. bagaje cu clichet
H Csomagrógzító pánt feszítővel
E Cinta para equipaje con carraca



No.	L (m)	daN	W (mm)	
82392	6	2500	50	6
82393	8	2500	50	6
82395	12	2500	50	5

PL Taśma do bagażu
GB Ratchet tie down
D Spanngurt
RUS Ремень для крепления багажа с трещоткой

CZ Pás na zavazadla z napínáním
RO Cordelina pt. bagaje cu clichet
H Csomagrógzító pánt feszítővel
E Cinta para equipaje con carraca

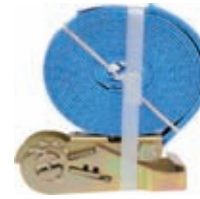

No.	L (m)	daN	W (mm)	
82343	4	1000	25	20

PL Taśma do bagażu
GB Ratchet tie down
D Spanngurt
RUS Ремень для крепления багажа с трещоткой

CZ Pás na zavazadla z napínáním
RO Cordelina pt. bagaje cu clichet
H Csomagrógzító pánt feszítővel
E Cinta para equipaje con carraca



No.	L (m)	daN	W (mm)	
82397	5	500	25	20

PL Plandeka
GB Tarpaulin
D Plane
RUS Тент

CZ Plachta
RO Husă
H Ponyva
E Toldo

57 g/m²



No.	m	g/m ²	
85122	2x3	57	30
85123	3x5	57	20
85124	4x5	57	10
85125	4x6	57	8
85126	5x8	57	5
85128	6x10	57	3
85129	8x12	57	2
85130	10x15	57	2

PL Plandeka
GB Tarpaulin
D Plane
RUS Тент

CZ Plachta
RO Husă
H Ponyva
E Toldo

75 g/m²



No.	m	g/m ²	
85112	2x3	75	30
85113	3x5	75	10
85114	4x5	75	10
85115	4x6	75	8
85116	5x8	75	5
85118	6x10	75	3
85119	8x12	75	2
85120	10x15	75	2

PL Plandeka
GB Tarpaulin
D Plane
RUS Тент

CZ Plachta
RO Husă
H Ponyva
E Toldo

90 g/m²



No.	m	g/m ²	
85020	2x3	90	30
85030	3x5	90	18
85040	4x5	90	9
85050	4x6	90	10
85060	5x8	90	5
85080	6x10	90	4
85090	8x12	90	2
85100	10x15	90	1

15

Power tools & accessories
Elektronarzędzia i akcesoria

Power tools
Elektronarzędzia

192-214



Impact drills	
Wiertarki udarowe.....	192
Rotary hammers	
Młoty udarowe.....	194
Cordless tools	
Urządzenia akumulatorowe.....	194
Impact wrenches	
Klucze udarowe.....	197
Angle grinders	
Szlifierki kątowe.....	197
Multi-purpose oscillating tools	
Wielofunkcyjne narzędzia oscylacyjne.....	200
Finishing sanders	
Szlifierki oscylacyjne.....	200
Orbital sanders	
Szlifierki mimośrodowe.....	200
Car polishers	
Polerki samochodowe.....	201
Jig saws	
Wyrzynarki.....	201
Sabre saws	
Piły szablaste.....	203
Circular saws	
Pilarki tarczowe.....	203
Planers	
Strugi.....	203
Hot air guns	
Opalarki.....	204
Glue guns	
Pistolety do klejenia.....	205
Spray guns	
Pistolety natryskowe.....	206
Soldering guns	
Lutownice.....	207
Paint & mortar mixers	
Mieszarki do zapraw i farb.....	209
Bench tools	
Elektronarzędzia stołowe.....	209
Pipe welders	
Zgrzewarki do rur.....	210
Water pumps	
Pompy wodne.....	211
Grass trimmers	
Podkaszarki.....	213
Hedge shears	
Nożyce do żywopłotu.....	214

Accessories
Akcesoria

214-219



Discs	
Tarcze.....	214
Drill chucks	
Uchwyty wiertarskie.....	215
Adapters	
Adaptery.....	215
Stands for power tools	
Statywy do elektronarzędzi.....	215
Spare blades, brushes, etc. for power tools	
Zapasowe ostrza, szczotki, końcówki do elektronarzędzi.....	216
Soldering iron accessories	
Akcesoria do lutownic.....	216
Gasoline water pump accessories	
Akcesoria do pomp spalinowych.....	218

PL Wiertarka udarowa
 GB Impact drill
 D Schlagbohrmaschine
 RUS Дрель ударная
 CZ Nárazová vrtačka
 RO Masina de gaurit
 H Kezelési utasítás
 E Taladradora de percusión

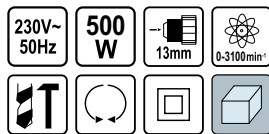

LUND

$L_{pA} = 88 \pm 3$ dB; $L_{wA} = 99 \pm 3$ dB; $a_h = 13,25 \pm 1,5 / 2,67 \pm 1,5$ m/s²

No.	W	min-1	
79024	500	0-3100	10

PL Wiertarka udarowa
 GB Impact drill
 D Schlagbohrmaschine
 RUS Дрель ударная
 CZ Nárazová vrtačka
 RO Masina de gaurit
 H Kezelési utasítás
 E Taladradora de percusión



STHOR

$L_{pA} = 90,0 \pm 3,0$ dB; $L_{wA} = 101,0 \pm 3,0$ dB; $a_h = 2,86 \pm 1,5 / 13,89 \pm 1,5$ m/s²

No.	W	min-1	
79002	580	0-3000	10

PL Wiertarka udarowa
 GB Impact drill
 D Schlagbohrmaschine
 RUS Дрель ударная
 CZ Nárazová vrtačka
 RO Masina de gaurit
 H Kezelési utasítás
 E Taladradora de percusión

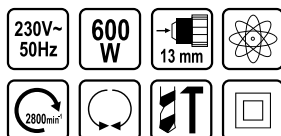

LUND

$L_{pA} = 90,0 \pm 3,0$ dB; $L_{wA} = 101,0 \pm 3,0$ dB; $a_h = 2,86 \pm 1,5 / 8,25 \pm 1,5$ m/s²

No.	W	min-1	
79004	600	2800	6

PL Wiertarka udarowa
 GB Impact drill
 D Schlagbohrmaschine
 RUS Дрель ударная
 CZ Nárazová vrtačka
 RO Masina de gaurit
 H Kezelési utasítás
 E Taladradora de percusión

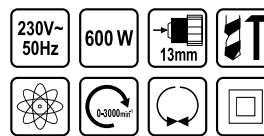

STHOR

$L_{pA} = 88,0 \pm 3,0$ dB; $L_{wA} = 99,0 \pm 3,0$ dB; $a_h = 2,86 \pm 1,5 / 8,67 \pm 1,5$ m/s²

No.	W	min-1	
79005	600	0-3000	6

PL Wiertarka udarowa
 GB Impact drill
 D Schlagbohrmaschine
 RUS Дрель ударная
 CZ Nárazová vrtačka
 RO Masina de gaurit
 H Kezelési utasítás
 E Taladradora de percusión

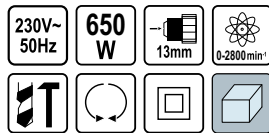

STHOR

$L_{pA} = 79,0 \pm 3,0$ dB; $L_{wA} = 90,0 \pm 3,0$ dB; $a_h = 2,67 \pm 1,5 / 8,00 \pm 1,5$ m/s²

No.	W	min-1	
79007	650	0-2800	10

PL Wiertarka udarowa
 GB Impact drill
 D Schlagbohrmaschine
 RUS Дрель ударная
 CZ Nárazová vrtačka
 RO Masina de gaurit
 H Kezelési utasítás
 E Taladradora de percusión

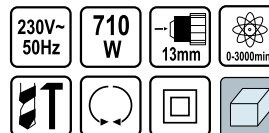

STHOR

$L_{pA} = 91,1 \pm 3,0$ dB; $L_{wA} = 102,1 \pm 3,0$ dB; $a_h = 2,48 \pm 1,5 / 14,67 \pm 1,5$ m/s²

No.	W	min-1	
79012	710	0-3000	10

PL Wiertarka udarowa
GB Impact drill
D Schlagbohrmaschine
RUS Дрель ударная
CZ Nárazová vrtačka
RO Masina de gaurit
H Kezelési utasítás
E Taladradora de percusión

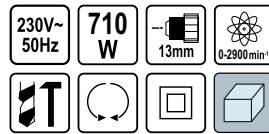

POWERUP

$L_{pa} = 92,0 \pm 3,0$ dB; $L_{wa} = 103,0 \pm 3,0$ dB; $a_n = 3,76 \pm 1,5 / 15,44 \pm 1,5$ m/s²

No.	W	min-1	
79013	710	0-2900	6

PL Wiertarka udarowa
GB Impact drill
D Schlagbohrmaschine
RUS Дрель ударная
CZ Nárazová vrtačka
RO Masina de gaurit
H Kezelési utasítás
E Taladradora de percusión

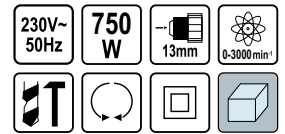

LUND

$L_{pa} = 78,0 \pm 3,0$ dB; $L_{wa} = 89,0 \pm 3,0$ dB; $a_n = 2,93 \pm 1,5 / 8,43 \pm 1,5$ m/s²

No.	W	min-1	
79015	750	0-3000	10

PL Wiertarka udarowa
GB Impact drill
D Schlagbohrmaschine
RUS Дрель ударная
CZ Nárazová vrtačka
RO Masina de gaurit
H Kezelési utasítás
E Taladradora de percusión



POWERUP

$L_{pa} = 95,5 \pm 3,0$ dB; $L_{wa} = 106,5 \pm 3,0$ dB; $a_n = 3,42 \pm 1,5 / 17,74 \pm 1,5$ m/s²

No.	W	min-1	
79018	850	0-2800	6

PL Wiertarka udarowa
GB Impact drill
D Schlagbohrmaschine
RUS Дрель ударная
CZ Nárazová vrtačka
RO Masina de gaurit
H Kezelési utasítás
E Taladradora de percusión

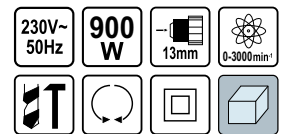

LUND

$L_{pa} = 90,0 \pm 3,0$ dB; $L_{wa} = 101,0 \pm 3,0$ dB; $a_n = 2,97 \pm 1,5 / 9,59 \pm 1,5$ m/s²

No.	W	min-1	
79022	900	0-3000	6

PL Wiertarka udarowa
GB Impact drill
D Schlagbohrmaschine
RUS Дрель ударная
CZ Nárazová vrtačka
RO Masina de gaurit
H Kezelési utasítás
E Taladradora de percusión

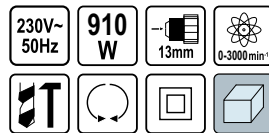

STWOR

$L_{pa} = 78,0 \pm 3,0$ dB; $L_{wa} = 89,0 \pm 3,0$ dB; $a_n = 2,93 \pm 1,5 / 8,43 \pm 1,5$ m/s²

No.	W	min-1	
79023	910	0-3000	10

PL Wiertarka udarowa
GB Impact drill
D Schlagbohrmaschine
RUS Дрель ударная
CZ Nárazová vrtačka
RO Masina de gaurit
H Kezelési utasítás
E Taladradora de percusión



POWERUP

$L_{pa} = 95,5 \pm 3,0$ dB; $L_{wa} = 106,5 \pm 3,0$ dB; $a_n = 3,42 \pm 1,5 / 17,74 \pm 1,5$ m/s²

No.	W	min-1	
79026	1100	0-2800	6

PL Wiertarko-wkrętarka akumulatorowa
 GB Cordless drill
 D Akkuschauber
 RUS Аккумуляторная дрель-шурупверт
 CZ Vrtáčko-utahovák akumulátorový
 RO Bormașină-șurubelniță cu acumulator
 H Akkumulátoros fűrés-gép-csavarbehajtó
 E Taladradora - atornilladora acu.

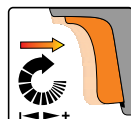

STIHL

$L_{pA} = 66,4 \pm 3,0$ dB; $L_{wA} = 77,4 \pm 3,0$ dB; $a_n = 1,412 \pm 1,5 / 0,419 \pm 1,1$ m/s²

No.	V	min-1	Ø (mm)	☐
79075	12	0-550	0.8-10	6

PL Wiertarko-wkrętarka akumulatorowa
 GB Cordless drill
 D Akkuschauber
 RUS Аккумуляторная дрель-шурупверт
 CZ Vrtáčko-utahovák akumulátorový
 RO Bormașină-șurubelniță cu acumulator
 H Akkumulátoros fűrés-gép-csavarbehajtó
 E Taladradora - atornilladora acu.



LUND

$L_{pA} = 64,2 \pm 3,0$ dB; $L_{wA} = 75,2 \pm 3,0$ dB; $a_n = 1,36 \pm 1,5$ m/s²

No.	V	min-1	Ø (mm)	☐
79056	14.4	550	0.8-10	5

PL Wiertarko-wkrętarka akumulatorowa
 GB Cordless drill
 D Akkuschauber
 RUS Аккумуляторная дрель-шурупверт
 CZ Vrtáčko-utahovák akumulátorový
 RO Bormașină-șurubelniță cu acumulator
 H Akkumulátoros fűrés-gép-csavarbehajtó
 E Taladradora - atornilladora acu.

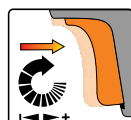
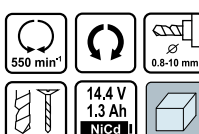

STIHL

$L_{pA} = 66,4 \pm 3,1$ dB; $L_{wA} = 77,4 \pm 3,1$ dB; $a_n = 1,412 \pm 1,5 / 0,419 \pm 1,6$ m/s²

No.	V	min-1	Ø (mm)	☐
79077	14.4	0-550	0.8-10	6

PL Wiertarko-wkrętarka akumulatorowa
 GB Cordless drill
 D Akkuschauber
 RUS Аккумуляторная дрель-шурупверт
 CZ Vrtáčko-utahovák akumulátorový
 RO Bormașină-șurubelniță cu acumulator
 H Akkumulátoros fűrés-gép-csavarbehajtó
 E Taladradora - atornilladora acu.



POWERUP

$L_{pA} = 63,60 \pm 3,0$ dB; $L_{wA} = 74,60 \pm 3,0$ dB; $a_n = 1,068 \pm 1,5 / 1,956 \pm 1,5$ m/s²

No.	V	min-1	Ø (mm)	☐
78971	14.4	0-350 / 0-1200	10	5

15

PL Wiertarko-wkrętarka akumulatorowa
 GB Cordless drill
 D Akkuschauber
 RUS Аккумуляторная дрель-шурупверт
 CZ Vrtáčko-utahovák akumulátorový
 RO Bormașină-șurubelniță cu acumulator
 H Akkumulátoros fűrés-gép-csavarbehajtó
 E Taladradora - atornilladora acu.

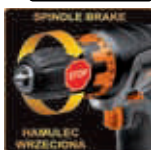
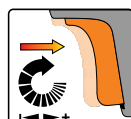
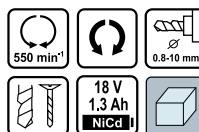

STIHL

$L_{pA} = 66,4 \pm 3,2$ dB; $L_{wA} = 77,4 \pm 3,2$ dB; $a_n = 1,412 \pm 1,5 / 0,419 \pm 1,7$ m/s²

No.	V	min-1	Ø (mm)	☐
79079	18	0-550	0.8-10	6

PL Wiertarko-wkrętarka akumulatorowa
 GB Cordless drill
 D Akkuschauber
 RUS Аккумуляторная дрель-шурупверт
 CZ Vrtáčko-utahovák akumulátorový
 RO Bormașină-șurubelniță cu acumulator
 H Akkumulátoros fűrés-gép-csavarbehajtó
 E Taladradora - atornilladora acu.



POWERUP

$L_{pA} = 66,20 \pm 3,0$ dB; $L_{wA} = 77,20 \pm 3,0$ dB; $a_n = 1,360 \pm 1,5 / 2,347 \pm 1,5$ m/s²

No.	V	min-1	Ø (mm)	☐
78973	18	0-350 / 0-1200	10	5

PL Akumulator
GB Battery
D Akkumulator
RUS Аккумулятор
CZ Akumulátor
RO Acumulatorul
H Akkumulátor
E Acumulador



STIHL

No.	V	for / dla	☐
79084	12	79075	30
79085	14.4	79077	30
79086	18	79079	30

PL Akumulator
GB Battery
D Akkumulator
RUS Аккумулятор
CZ Akumulátor
RO Acumulatorul
H Akkumulátor
E Acumulador



POWERUP

No.	V	for / dla	☐
78975	10.8	78970	50
78976	14.4	78971	30
78977	18	78973	30

PL Ładowarka
GB Battery charger
D Ladegerät
RUS Зарядное устройство
CZ Nabíječka baterií
RO Redresor
H Akkumulátortöltő
E Rectificador



STIHL

No.	V	for / dla	☐
79087	15V ~, 400mA	79084	30
79088	18V ~, 400mA	79085	30
79089	24V ~, 400mA	79086	20

PL Ładowarka
GB Battery charger
D Ladegerät
RUS Зарядное устройство
CZ Nabíječka baterií
RO Redresor
H Akkumulátortöltő
E Rectificador



POWERUP

No.	V	for / dla	☐
78978	10.8	78970; 78975	30
78979	14.4	78971; 78976	30
78980	18	78973; 78977	30

15

PL Wkrętarka akumulatorowa
GB Cordless screwdriver
D Akku-schrauber
RUS Аккумуляторный шуруповерт
CZ Utahovák akumulátorový
RO Șurubelniță cu acumulator
H Akkumulátoros csavarbehajtó
E Herramienta de resistencia para soldar

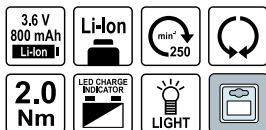

LUND

$L_{pA} = 58,1 \pm 3,0$ dB; $L_{wA} = 69,1 \pm 3,0$ dB; $a_n = 0,409 \pm 1,5$ m/s²

No.	V	min-1	☐
79060	3.6	250	20

PL Akumulatorowe nożyce do trawy i krzewów
GB Cordless grass and shrub shears
D Akkuschere mit Gras- und Strauchmesser
RUS Аккумуляторные ножницы для травы и кустов
CZ Akumulátorové nůžní Ø 110 mm YX DN-Fe
RO Trimmer cu acumulator pt. iarba si gard viu
H Foarfecele cu acumulator pt. tăiat iarba
E Tijeras a batería para hierba y arbustos

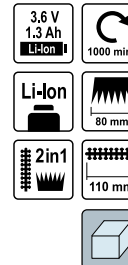

FLO

$L_{pA} = 74,6 \pm 3,0$ dB; $L_{wA} = 86,4 \pm 3,0$ dB; $a_n = 1,63 \pm 1,5$ m/s²

No.	V	min-1	☐
79500	3.6	1000	8

- PL Akumulatorowe nożyce do trawy i krzewów
 GB Cordless grass and shrub shears
 D Akkuscherer mit Gras- und Strauchmesser
 RUS Аккумуляторные ножницы для травы и кустов
 CZ Akumulátorové nůžn. Sa trávy a keře
 RO Trimmer cu acumulator pt. iarba si gard viu
 H Foaifecele cu acumulator pt. táiat iarba
 E Tijeras a batería para hierba y arbustos



3,6 V
1,3 Ah
Li-Ion

1000 min⁻¹

Li-Ion

80 mm

2in1

110 mm



$L_{pa} = 74,6 \pm 3,0$ dB; $L_{max} = 86,4 \pm 3,0$ dB; $a_n = 1,63 \pm 1,5$ m/s²

No.	W	min-1	☐
79501	1000		8

- PL Elektryczny klucz udarowy
 GB Electric impact wrench
 D Elektro-Schlagschrauber
 RUS Электрический гайковёрт
 CZ Elektrický rázový utahovák
 RO Chele electrică
 H Elektromos ütvecsavarozó
 E llave de impacto eléctrica



230V~
50Hz

800 W

2200 min⁻¹

325 Nm

1/2"
12.5 mm

17, 19
21, 22
mm



$L_{pa} = 87,5 \pm 3,0$ dB; $L_{max} = 98,5 \pm 3,0$ dB; $a_n = 9,93 \pm 1,5$ m/s²

No.	W	min-1	☐
57091	800	2200	5

- PL Szlifierka kątowa
 GB Angle grinder
 D Winkelschleifmaschine
 RUS Углошлифовальная машинка
 CZ Úhlová bruska
 RO Polizor unghiular
 H Sarokcsiszoló
 E Lijadera de angulo



230V~
50Hz

500 W

12000 min⁻¹

115mm

M14



$L_{pa} = 85 \pm 3$ dB; $L_{max} = 96 \pm 3$ dB; $a_n = 3,82 \pm 1,5$ m/s²

No.	W	min-1	☐
79098	500	12000	10

- PL Szlifierka kątowa
 GB Angle grinder
 D Winkelschleifmaschine
 RUS Углошлифовальная машинка
 CZ Úhlová bruska
 RO Polizor unghiular
 H Sarokcsiszoló
 E Lijadera de angulo



230V~
50Hz

580 W

11000 min⁻¹

115mm

M14



$L_{pa} = 82,0 \pm 3,0$ dB; $L_{max} = 93,0 \pm 3,0$ dB; $a_n = 3,44 \pm 1,5$ m/s²

No.	W	min-1	☐
79104	580	11000	10

- PL Szlifierka kątowa
 GB Angle grinder
 D Winkelschleifmaschine
 RUS Углошлифовальная машинка
 CZ Úhlová bruska
 RO Polizor unghiular
 H Sarokcsiszoló
 E Lijadera de angulo



230V~
50Hz

650 W

11000 min⁻¹

125mm

M14



$L_{pa} = 81,5 \pm 3,0$ dB; $L_{max} = 92,5 \pm 3,0$ dB; $a_n = 3,44 \pm 1,5$ m/s²

No.	W	min-1	☐
79105	650	11000	10

- PL Szlifierka kątowa
 GB Angle grinder
 D Winkelschleifmaschine
 RUS Углошлифовальная машинка
 CZ Úhlová bruska
 RO Polizor unghiular
 H Sarokcsiszoló
 E Lijadera de angulo



230V~
50Hz

650 W

10000 min⁻¹

125 mm

M14

LED

CARBON BRUSH INDICATOR
WSKAZNIK ZŁYCZYK SZCZOTEK

MOTOR DAMAGE INDICATOR
WSKAZNIK ZNIACENIA NA SILNIKU



$L_{pa} = 88,6 \pm 3,0$ dB; $L_{max} = 101,6 \pm 3,0$ dB; $a_n = 4,65 \pm 1,5$ m/s²

No.	W	min-1	☐
79100	650	10000	10

PL Szlifierka kątowa
 GB Angle grinder
 D Winkelschleifmaschine
 RUS Углошлифовальная машинка
 CZ Úhlová bruska
 RO Polizor unghiular
 H Sarokcsiszoló
 E Lijadera de angulo

230V~50Hz 710 W 11000min⁻¹
 125mm M14



$L_{pA} = 81,5 \pm 3,0 \text{ dB}$; $L_{wA} = 92,5 \pm 3,0 \text{ dB}$; $a_n = 3,44 \pm 1,5 \text{ m/s}^2$

No.	W	min-1	
79108	710	11000	10

PL Szlifierka kątowa
 GB Angle grinder
 D Winkelschleifmaschine
 RUS Углошлифовальная машинка
 CZ Úhlová bruska
 RO Polizor unghiular
 H Sarokcsiszoló
 E Lijadera de angulo

230V~50Hz 710 W 11500min⁻¹
 115mm M14



$L_{pA} = 88,0 \pm 3,0 \text{ dB}$; $L_{wA} = 99,0 \pm 3,0 \text{ dB}$; $a_n = 3,33 \pm 1,5 \text{ m/s}^2$

No.	W	min-1	
79117	710	11500	6

PL Szlifierka kątowa
 GB Angle grinder
 D Winkelschleifmaschine
 RUS Углошлифовальная машинка
 CZ Úhlová bruska
 RO Polizor unghiular
 H Sarokcsiszoló
 E Lijadera de angulo

230V~50Hz 900 W 10500min⁻¹
 125mm M14



$L_{pA} = 86,3 \pm 3,0 \text{ dB}$; $L_{wA} = 97,3 \pm 3,0 \text{ dB}$; $a_n = 8,673 \pm 1,5 \text{ m/s}^2$

No.	W	min-1	
79116	900	10500	6

PL Szlifierka kątowa
 GB Angle grinder
 D Winkelschleifmaschine
 RUS Углошлифовальная машинка
 CZ Úhlová bruska
 RO Polizor unghiular
 H Sarokcsiszoló
 E Lijadera de angulo

230V~50Hz 900 W 11000min⁻¹ 125mm M14
 LED CARBON BRUSH INDICATOR MOTOR DAMAGE INDICATOR



$L_{pA} = 88,6 \pm 3,0 \text{ dB}$; $L_{wA} = 101,6 \pm 3,0 \text{ dB}$; $a_n = 4,65 \pm 1,5 \text{ m/s}^2$

No.	W	min-1	
79113	900	11000	10

PL Szlifierka kątowa
 GB Angle grinder
 D Winkelschleifmaschine
 RUS Углошлифовальная машинка
 CZ Úhlová bruska
 RO Polizor unghiular
 H Sarokcsiszoló
 E Lijadera de angulo

230V~50Hz 950 W 10000min⁻¹ 125mm M14
 LED CARBON BRUSH INDICATOR MOTOR DAMAGE INDICATOR



$L_{pA} = 86 \pm 3,0 \text{ dB}$; $L_{wA} = 97 \pm 3,0 \text{ dB}$; $a_n = 11,75 \pm 1,5 \text{ m/s}^2$

No.	W	min-1	
79114	950	10000	8

PL Szlifierka kątowa
 GB Angle grinder
 D Winkelschleifmaschine
 RUS Углошлифовальная машинка
 CZ Úhlová bruska
 RO Polizor unghiular
 H Sarokcsiszoló
 E Lijadera de angulo

230V~50Hz 1200 W 12000min⁻¹ 125mm M14



$L_{pA} = 94,3 \pm 3,0 \text{ dB}$; $L_{wA} = 105,3 \pm 3,0 \text{ dB}$; $a_n = 9,159 \pm 1,5 \text{ m/s}^2$

No.	W	min-1	
79120	1200	12000	4

15

- PL Szlifierka kątowa
- GB Angle grinder
- D Winkelschleifmaschine
- RUS Углошлифовальная машинка
- CZ Úhlová bruska
- RO Polizor unghiular
- H Sarokcsiszoló
- E Lijadera de angulo

230V~50Hz 1400 W 8000 min⁻¹ 180 mm M14

LED CARBON BRUSH INDICATOR WSKAZNIK ZŁYCZGA SZCZOTEK MOTOR DAMAGE INDICATOR WSKAZNIK ZWRAŃCJA NA SILNIKU



L_{pa} = 86 ± 3,0 dB; L_{wa} = 97 ± 3,0 dB; a_n = 11,75 ± 1,5 m/s²

No.	W	min-1	
79129	1400	8000	4

- PL Szlifierka kątowa
- GB Angle grinder
- D Winkelschleifmaschine
- RUS Углошлифовальная машинка
- CZ Úhlová bruska
- RO Polizor unghiular
- H Sarokcsiszoló
- E Lijadera de angulo

230V~50Hz 2000 W 6500 min⁻¹ 230 mm M14



L_{pa} = 91,0 ± 3,0 dB; L_{wa} = 102,0 ± 3,0 dB; a_n = 5,28 ± 1,5 m/s²

No.	W	min-1	
79148	2000	6500	2

- PL Szlifierka kątowa
- GB Angle grinder
- D Winkelschleifmaschine
- RUS Углошлифовальная машинка
- CZ Úhlová bruska
- RO Polizor unghiular
- H Sarokcsiszoló
- E Lijadera de angulo

230V~50Hz 2150 W 6000 min⁻¹ 230 mm M14



L_{pa} = 95,0 ± 3,0 dB; L_{wa} = 106,0 ± 3,0 dB; a_n = 6,17 ± 1,5 m/s²

No.	W	min-1	
79140	2150	6000	2

- PL Szlifierka kątowa
- GB Angle grinder
- D Winkelschleifmaschine
- RUS Углошлифовальная машинка
- CZ Úhlová bruska
- RO Polizor unghiular
- H Sarokcsiszoló
- E Lijadera de angulo

230V~50Hz 2300 W 6200 min⁻¹ 230 mm M14



L_{pa} = 94,0 ± 3,0 dB; L_{wa} = 105,0 ± 3,0 dB; a_n = 6,04 ± 1,5 m/s²

No.	W	min-1	
79141	2300	6200	2

- PL Pilarka dwutarczowa
- GB Double blade saw
- D Säge mit zwei Sägeblättern
- RUS Многоцельная двухдисковая пила
- CZ Dvoukotoučová protiběhací S10
- RO Ferăstrău cu două discuri
- H Kéttárcsás daraboló
- E Máquina de serrar de dos discos

230V~50Hz 900 W 4200 min⁻¹ Ø125 mm x2

30 mm



L_{pa} = 90,0 ± 3,0 dB; L_{wa} = 101,0 ± 3,0 dB; a_n = 3,616 ± 1,5 / 4,437 ± 1,5 m/s²

No.	W	min-1	
79255	900	4200	4

- PL Uniwersalna szlifierka wielofunkcyjna
- GB Mini grinder
- D Universal-Mehrzweckschleifmaschine
- RUS Универсальная шлифовальная машина
- CZ Víceúčelová univerzální bruska
- RO Mașina de șlefuit universală multifuncțională
- H Universalis dauglafunkcis slifuoklis
- E Lijadora multifunción

230V~50Hz 135 W 40 pcs

2,3, 3,2 2mm 10000-35000 min⁻¹



L_{pa} = 72,0 ± 3,0 dB; L_{wa} = 83,0 ± 3,0 dB; a_n = 2,60 ± 1,5 m/s²

No.	W	min-1	
79314	135	10000-35000	10

- PL Uniwersalna szlifierka wielofunkcyjna
 GB Mini grinder
 D Universal-Mehrweckschleifmaschine
 RUS Универсальная шлифовальная машина
 CZ Všeúčelová univerzální bruska
 RO Maşina de şlefuit universală multifuncţională
 H Universális daugfunkcis sliřuoklis
 E Lijadora multifunci3n

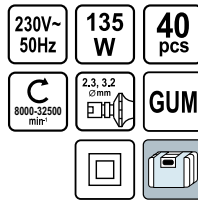

$L_{PA} = 69,1 \pm 3,0$ dB; $L_{MA} = 80,1 \pm 3,0$ dB; $a_n = 0,652 \pm 1,5$ m/s²

No.	W	min-1	
79316	135	8000-35000	10

- PL Wielofunkcyjne narzędzie oscylacyjne
 GB Multi-purpose oscillating tool
 D Multifunktionales Oszillationswerkzeug
 RUS Многофункциональный инструмент
 CZ Multifunkční oscilační nářadí
 RO Unealtă multifuncţională oscilantă
 H Multifunkci3s rezg3 szerszám
 E Herramienta oscilatoria multiusos

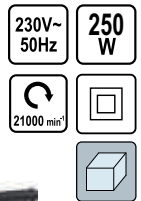

$L_{PA} = 86 \pm 3$ dB; $L_{MA} = 97 \pm 3$ dB; $a_n = 6,48 \pm 1,5$ m/s²

No.	W	min-1	
79237	250	21000	12

- PL Wielofunkcyjne narzędzie oscylacyjne
 GB Multi-purpose oscillating tool
 D Multifunktionales Oszillationswerkzeug
 RUS Многофункциональный инструмент
 CZ Multifunkční oscilační nářadí
 RO Unealtă multifuncţională oscilantă
 H Multifunkci3s rezg3 szerszám
 E Herramienta oscilatoria multiusos

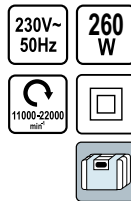

$L_{PA} = 87,9 \pm 3,0$ dB; $L_{MA} = 98,9 \pm 3,0$ dB; $a_n = 7,006 \pm 1,5$ m/s²

No.	W	min-1	
79238	260	11000-22000	6

- PL Szlifierka oscylacyjna
 GB Finishing sander
 D Schwingschleifer
 RUS Виброшлифмашина
 CZ Oscilační bruska
 RO Polizor oscilant
 H Vibráci3s csiszológép
 E Lijadora de oscilaci3n

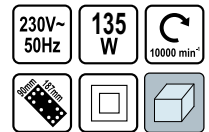

$L_{PA} = 84,0 \pm 3,0$ dB; $L_{MA} = 95,0 \pm 3,0$ dB; $a_n = 3,7 \pm 1,5$ m/s²

No.	W	min-1	
79491	135	10000	6

- PL Szlifierka oscylacyjna
 GB Finishing sander
 D Schwingschleifer
 RUS Виброшлифмашина
 CZ Oscilační bruska
 RO Polizor oscilant
 H Vibráci3s csiszológép
 E Lijadora de oscilaci3n

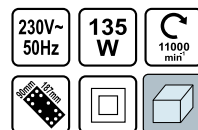

$L_{PA} = 79,7 \pm 3,0$ dB; $L_{MA} = 90,7 \pm 3,0$ dB; $a_n = 6,140 \pm 1,5 / 7,629 \pm 1,5$ m/s²

No.	W	min-1	
79493	135	11000	10

- PL Szlifierka mimořadova
 GB Orbital sander
 D Exzentrische schleifmaschine
 RUS Эксцентриковая шлифовальная машина
 CZ Excentrická bruska
 RO Polizor cu excentric
 H Excenter csiszológép
 E Pulidor excentrico

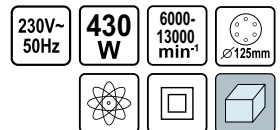

$L_{PA} = 81 \pm 3,0$ dB; $L_{MA} = 92 \pm 3,0$ dB; $a_n = 10,8 \pm 1,5$ m/s²

No.	W	min-1	
79309	430	6000-13000	6

- PL Polerka samochodowa
- GB Car polisher
- D Autopoliermaschine
- RUS Полировальная машинка
- CZ Leštička na automobily
- RO Masina de lustruit automobile
- H Gépkocsi polírozógép
- E Maquina para pulir coches

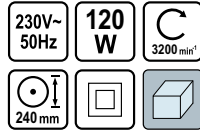

LUND

$L_{pa} = 55,0 \pm 3,0$ dB; $L_{wa} = 66,0 \pm 3,0$ dB; $a_n = 14,8 \pm 1,5$ m/s²

No.	W	min-1	
82942	120	3200	6

- PL Polerka samochodowa
- GB Car polisher
- D Autopoliermaschine
- RUS Полировальная машина
- CZ Leštička na automobily
- RO Masina de lustruit automobile
- H Gépkocsi polírozógép
- E Maquina para pulir coches

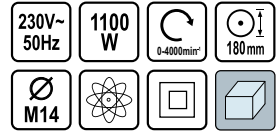

LUND

$L_{pa} = 68 \pm 3,0$ dB; $L_{wa} = 79 \pm 3,0$ dB; $a_n = 5,07 \pm 1,5$ m/s²

No.	W	min-1	
78945	1100	1500-4200	4

- PL Polerka samochodowa
- GB Car polisher
- D Autopoliermaschine
- RUS Полировальная машинка
- CZ Leštička na automobily
- RO Masina de lustruit automobile
- H Gépkocsi polírozógép
- E Maquina para pulir coches

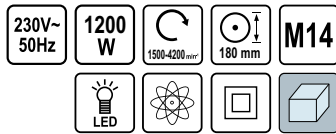

POWERUP

$L_{pa} = 65 \pm 3,0$ dB; $L_{wa} = 76 \pm 3,0$ dB; $a_n = 4,94 \pm 1,5$ m/s²

No.	W	min-1	
78947	1200	0-4000	4

- PL Polerka samochodowa
- GB Car polisher
- D Autopoliermaschine
- RUS Полировальная машина
- CZ Leštička na automobily
- RO Masina de lustruit automobile
- H Gépkocsi polírozógép
- E Maquina para pulir coches

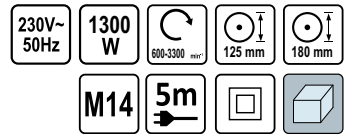

POWERUP

$L_{pa} = 89,0 \pm 3,0$ dB; $L_{wa} = 100,0 \pm 3,0$ dB; $a_n = 5,50 \pm 1,5$ m/s²

No.	W	min-1	
78948	1300	600-3300	4

- PL Polerka samochodowa
- GB Car polisher
- D Autopoliermaschine
- RUS Полировальная машина
- CZ Leštička na automobily
- RO Masina de lustruit automobile
- H Gépkocsi polírozógép
- E Maquina para pulir coches



POWERUP

$L_{pa} = 85 \pm 3,0$ dB; $L_{wa} = 96 \pm 3,0$ dB; $a_n = 11,59 \pm 1,5$ m/s²

No.	W	min-1	
78950	1400	3000	4

- PL Wyrzynarka
- GB Electric jig saw
- D Stichsäge
- RUS Лобзик электрический
- CZ Elektrická vytezávací pila
- RO Fierastrau pendular
- H Elektromos dekopír fűrész
- E Cortadora eléctrica

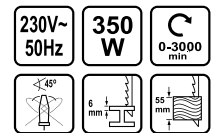

STORJ

$L_{pa} = 90,0 \pm 3,0$ dB; $L_{wa} = 101,0 \pm 3,0$ dB; $a_n = 4,73 \pm 1,5 / 7,66 \pm 1,5$ m/s²

No.	W	min-1	
79332	350	0-3000	10

PL Wyrzynarka
GB Electric jig saw
D Stichsäge
RUS Лобзик электрический
CZ Elektrická vyřezávací pila
RO Fierastrau pendular
H Elektromos dekopír fűrész
E Cortadora eléctrica

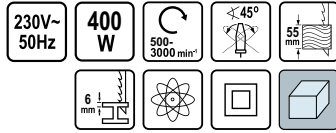

$L_{pA} = 85,3 \pm 3,0$ dB; $L_{wA} = 96,3 \pm 3,0$ dB; $a_n = 6,59 \pm 1,5 / 12,59 \pm 1,5$ m/s²

No.	W	min-1	
79484	400	500-3000	10

PL Wyrzynarka
GB Electric jig saw
D Stichsäge
RUS Лобзик электрический
CZ Elektrická vyřezávací pila
RO Fierastrau pendular
H Elektromos dekopír fűrész
E Cortadora eléctrica

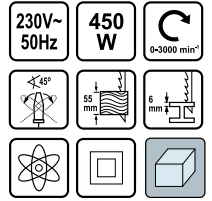

$L_{pA} = 84,0 \pm 3,0$ dB; $L_{wA} = 95,0 \pm 3,0$ dB; $a_n = 7,33 \pm 1,5 / 4,40 \pm 1,5$ m/s²

No.	W	min-1	
79479	450	0-3000	10

PL Wyrzynarka
GB Electric jig saw
D Stichsäge
RUS Лобзик электрический
CZ Elektrická vyřezávací pila
RO Fierastrau pendular
H Elektromos dekopír fűrész
E Cortadora eléctrica

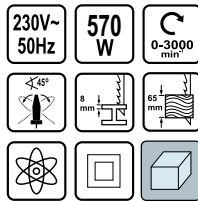

$L_{pA} = 90,0 \pm 3,0$ dB; $L_{wA} = 101,0 \pm 3,0$ dB; $a_n = 12,72 \pm 1,5 / 5,97 \pm 1,5$ m/s²

No.	W	min-1	
79482	570	0-3000	10

PL Wyrzynarka
GB Electric jig saw
D Stichsäge
RUS Лобзик электрический
CZ Elektrická vyřezávací pila
RO Fierastrau pendular
H Elektromos dekopír fűrész
E Cortadora eléctrica

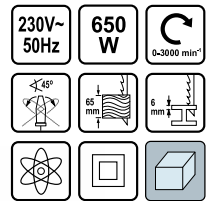

$L_{pA} = 84,0 \pm 3,0$ dB; $L_{wA} = 95,0 \pm 3,0$ dB; $a_n = 7,33 \pm 1,5 / 4,40 \pm 1,5$ m/s²

No.	W	min-1	
79481	650	0-3000	10

15

PL Wyrzynarka
GB Electric jig saw
D Stichsäge
RUS Лобзик электрический
CZ Elektrická vyřezávací pila
RO Fierastrau pendular
H Elektromos dekopír fűrész
E Cortadora eléctrica

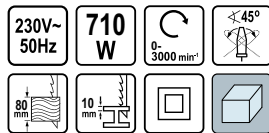

$L_{pA} = 95,0 \pm 3,0$ dB; $L_{wA} = 106,0 \pm 3,0$ dB; $a_n = 13,21 \pm 1,5 / 5,63 \pm 1,5$ m/s²

No.	W	min-1	
79477	710	0-3000	10

PL Wyrzynarka
GB Electric jig saw
D Stichsäge
RUS Лобзик электрический
CZ Elektrická vyřezávací pila
RO Fierastrau pendular
H Elektromos dekopír fűrész
E Cortadora eléctrica

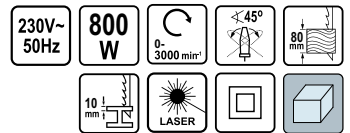

$L_{pA} = 85,78 \pm 3,0$ dB; $L_{wA} = 96,78 \pm 3,0$ dB; $a_n = 15,063 \pm 1,5 / 20,492 \pm 1,5$ m/s²

No.	W	min-1	
79478	800	0-3000	10

- PL Pila szablasta
GB Sabre saw
D Stichsäge
RUS Сабельная пила
- CZ Šavlová pila
RO Ferăstrău electric
H Szablyafűrész
E Sierra de sable

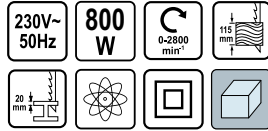

$L_{pa} = 88,0 \pm 3,0$ dB; $L_{ma} = 99,0 \pm 3,0$ dB; $a_h = 11,34 \pm 1,5 / 12,15 \pm 1,5$ m/s²

No.	W	min-1	
79475	800	0-2800	4

- PL Pilarka ręczna
GB Circular saw
D Handkreissäge
RUS Пила циркулярная ручная
CZ Pila kotoučová
RO Fierastrău circular
H Kézi körfűrészgép
E Sierra de disco

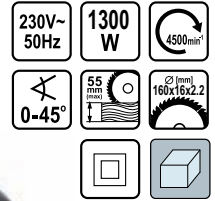

$L_{pa} = 95,5 \pm 3,0$ dB; $L_{ma} = 106,5 \pm 3,0$ dB; $a_h = 1,749 \pm 1,5 / 2,462 \pm 1,5$ m/s²

No.	W	min-1	
79252	1300	4500	4

- PL Pilarka ręczna
GB Circular saw
D Handkreissäge
RUS Пила циркулярная ручная
CZ Pila kotoučová
RO Fierastrău circular
H Kézi körfűrészgép
E Sierra de disco

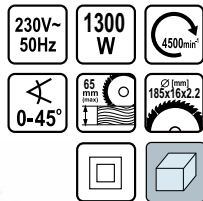

$L_{pa} = 95,5 \pm 3,0$ dB; $L_{ma} = 106,5 \pm 3,0$ dB; $a_h = 1,749 \pm 1,5 / 2,462 \pm 1,6$ m/s²

No.	W	min-1	
79253	1300	4500	4

- PL Pilarka ręczna
GB Circular saw
D Handkreissäge
RUS Пила циркулярная ручная
CZ Pila kotoučová
RO Fierastrău circular
H Kézi körfűrészgép
E Sierra de disco

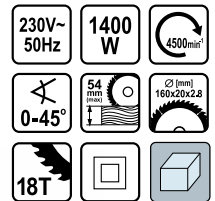

$L_{pa} = 95,4 \pm 3,0$ dB; $L_{ma} = 106,4 \pm 3,0$ dB; $a_h = 4,40 \pm 1,5$ m/s²

No.	W	min-1	
79334	1400	4500	4

- PL Strug elektryczny do drewna
GB Electric planer
D Elektro-höbel
RUS Электрорубанок
CZ Elektrický hoblík
RO Rindea electrică manuală
H Elektromos gyalu
E Limadora eléctrica



$L_{pa} = 76,6 \pm 3,0$ dB; $L_{ma} = 98,3 \pm 3,0$ dB; $a_h = 7,47 \pm 1,5$ m/s²

No.	W	min-1	
79413	710	16500	4

- PL Strug elektryczny do drewna
GB Electric planer
D Elektro-höbel
RUS Электрорубанок
CZ Elektrický hoblík
RO Rindea electrică manuală
H Elektromos gyalu
E Limadora eléctrica

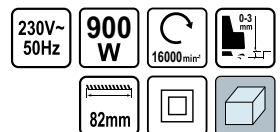

$L_{pa} = 91,2 \pm 3,0$ dB; $L_{ma} = 102,2 \pm 3,0$ dB; $a_h = 4,130 \pm 1,5$ m/s²

No.	W	min-1	
79410	900	16000	6

PL Opalarka
GB Hot air gun
D Heissluftpistole
RUS Фен технический

CZ Opalovací stroj
RO Pistol aer cald
H Hőlégfúvó tartozékokkal
E Secadora

230V~50Hz
I - 1000W
II - 2000W

I - 350°C
II - 550°C



LUND

No.	W	°C	☐
79324	750-1500	300-500	10

PL Opalarka
GB Hot air gun
D Heissluftpistole
RUS Фен технический

CZ Opalovací stroj
RO Pistol aer cald
H Hőlégfúvó tartozékokkal
E Secadora

230V~50Hz
I - 1000W
II - 1500W

I - 375°C
II - 495°C



STMOR

No.	W	°C	☐
79327	1000-1500	375-495	10

PL Opalarka z akcesoriami
GB Hot air gun with accessories
D Heissluftpistole
RUS Фен технический в наборе

CZ Opalovací stroj w s příslušenstvím
RO Fion cu accesorii pt. ars vopseaua
H Hőlégfúvó tartozékokkal
E Secadora con accesorios

230V~50Hz
I - 375°C
II - 495°C

I - 1000W
II - 1500W



STMOR

No.	W	°C	☐
79328	1000-1500	375-495	5

PL Opalarka
GB Hot air gun
D Heissluftpistole
RUS Фен технический

CZ Opalovací stroj
RO Pistol aer cald
H Hőlégfúvó tartozékokkal
E Secadora

230V~50Hz
I - 1000W
II - 2000W

I - 350°C
II - 550°C



STMOR

No.	W	°C	☐
79320	1000-2000	350-550	10

PL Opalarka z akcesoriami
GB Hot air gun with accessories
D Heissluftpistole
RUS Фен технический в наборе

CZ Opalovací stroj w s příslušenstvím
RO Fion cu accesorii pt. ars vopseaua
H Hőlégfúvó tartozékokkal
E Secadora con accesorios

230V~50Hz
2000 W

I - 1000 W
II - 2000W

I - 350°C
II - 550°C



LUND

No.	W	°C	☐
79318	1000-2000	350-550	10

PL Opalarka z akcesoriami
GB Hot air gun with accessories
D Heissluftpistole
RUS Фен технический в наборе

CZ Opalovací stroj w s příslušenstvím
RO Fion cu accesorii pt. ars vopseaua
H Hőlégfúvó tartozékokkal
E Secadora con accesorios

230V~50Hz
I - 1000W
II - 2000W

I - 350°C
II - 550°C



LUND

No.	W	°C	☐
79325	1000-2000	350-550	10

PL Opalarka z akcesoriami
GB Hot air gun with accessories
D Heißluftpistole
RUS Фен технический в наборе

CZ Opalovací stroj v s příslušenstvím
RO Fion cu accesorii pt. ars vopseaua
H Hőlégtűvő tartozékokkal
E Secadora con accesorios

230V~
50Hz

2000
W

I - 250°C
II - 550°C

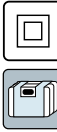

POWERUP

No.	W	°C	
79329	2000	250-550	5

PL Pistolet do klejenia
GB Electric glue gun
D Heißklebepistole
RUS Пистолет для клея

CZ Pistole na lepení
RO Pistol pt. lipit
H Ragasztópisztoly
E Pistola de cola

230V~
50Hz

8(30)
W

2x
∅7mm

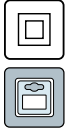

LUND

No.	W	
73040	8 (30)	12/48

PL Pistolet do klejenia
GB Electric glue gun
D Heißklebepistole
RUS Пистолет для клея

CZ Pistole na lepení
RO Pistol pt. lipit
H Ragasztópisztoly
E Pistola de cola

230V~
50Hz

12(72)
W

2x
∅11mm



LUND

No.	W	
73051	12 (72)	12/48

PL Pistolet do klejenia
GB Electric glue gun
D Heißklebepistole
RUS Пистолет для клея

CZ Pistole na lepení
RO Pistol pt. lipit
H Ragasztópisztoly
E Pistola de cola

230V~
50Hz

15(40)
W

200
°C

3-5
s

∅11

8-12
g/min



POWERUP

No.	W	
73056	15 (40)	6/48

PL Pistolet do klejenia
GB Electric glue gun
D Heißklebepistole
RUS Пистолет для клея

CZ Pistole na lepení
RO Pistol pt. lipit
H Ragasztópisztoly
E Pistola de cola

230V~
50Hz

15(100)
W

2x
∅11mm



STIHL

No.	W	
73052	15 (100)	12/48

PL Pistolet do klejenia
GB Electric glue gun
D Heißklebepistole
RUS Пистолет для клея

CZ Pistole na lepení
RO Pistol pt. lipit
H Ragasztópisztoly
E Pistola de cola

230V~
50Hz

16W

2x
∅11mm



LUND

No.	W	
73060	16	10

PL Pistolet do klejenia
GB Electric glue gun
D HeiSSklebepistole
RUS Пистолет для клея

CZ Pistole na lepení
RO Pistol pt. lipit
H Ragasztópisztoly
E Pistola de cola

230V~50Hz 16W 200 °C
3-5 s 6x Ø11mm 10 g/min
LED CHARGE INDICATOR



POWER UP

No.	W	Icon
73058	16	10

PL Pistolet do klejenia
GB Electric glue gun
D HeiSSklebepistole
RUS Пистолет для клея

CZ Pistole na lepení
RO Pistol pt. lipit
H Ragasztópisztoly
E Pistola de cola

230V~50Hz 20 (200) W 200 °C
3-5 s Ø11 15 g/min



POWER UP

No.	W	Icon
73059	20 (200)	12/24

PL Pistolet do klejenia
GB Electric glue gun
D HeiSSklebepistole
RUS Пистолет для клея

CZ Pistole na lepení
RO Pistol pt. lipit
H Ragasztópisztoly
E Pistola de cola

230V~50Hz 23 (80) W 200 °C
3-5 s Ø11 14-16 g/min



POWER UP

No.	W	Icon
73057	23 (80)	6/48

PL Elektryczny pistolet natryskowy
GB Electric spray gun
D Elektro farbspritzpistole
RUS Электрический пульверизатор
CZ Elektrická pistole malířská
RO Pistol de vopsit - electric
H Elektromos festékszórpisztoly
E Pístola de pintar electr.

230V~50Hz 80 W 0.28 l/min
800 ml



POWER UP

$L_{pa} = 84,1 \pm 3,0$ dB; $L_{wa} = 97,1 \pm 3,0$ dB; $a_{\eta} = 6,6 \pm 1,5$ m/s²

No.	W	Icon
79761	80	5

PL Elektryczny pistolet natryskowy
GB Electric spray gun
D Elektro farbspritzpistole
RUS Электрический пульверизатор
CZ Elektrická pistole malířská
RO Pistol de vopsit - electric
H Elektromos festékszórpisztoly
E Pístola de pintar electr.

230V~50Hz 100 W 0.28 l/min
800 ml



POWER UP

$L_{pa} = 89,9 \pm 3,0$ dB; $L_{wa} = 102,9 \pm 3,0$ dB; $a_{\eta} = 6,6 \pm 1,5$ m/s²

No.	W	Icon
79760	100	5

PL Elektryczny pistolet natryskowy
GB Electric spray gun
D Elektro farbspritzpistole
RUS Электрический пульверизатор
CZ Elektrická pistole malířská
RO Pistol de vopsit - electric
H Elektromos festékszórpisztoly
E Pístola de pintar electr.

230V~50Hz 500 W 0.85 l/min
700 ml HVLP



POWER UP

$L_{pa} = 76,93 \pm 3,0$ dB; $L_{wa} = 87,93 \pm 3,0$ dB; $a_{\eta} = 1,564 \pm 1,5$ m/s²

No.	W	Icon
79764	500	4

PL Lutownica oporowa
GB Soldering iron
D Delőtkolben
RUS Электропаяльник

CZ Pájka odporová
RO Ciocan de lipit
H Huforrasztópáka
E Soldador de resistencia

230V~
50Hz

400°C



STHOR

No.	W	
79365	30	25/50
79366	40	25/50
79367	60	25/50
79368	80	25/50

PL Lutownica oporowa
GB Soldering iron
D Delőtkolben
RUS Электропаяльник

CZ Pájka odporová
RO Ciocan de lipit
H Huforrasztópáka
E Soldador de resistencia

230V~
50Hz

400°C



5-10
min



POWER UP

No.	W	Ø (mm)	
79382	40	5	25/50
79383	60	6	25/50

PL Lutownica oporowa
GB Soldering iron
D Delőtkolben
RUS Электропаяльник

CZ Pájka odporová
RO Ciocan de lipit
H Huforrasztópáka
E Soldador de resistencia

230V~
50Hz

100
W

400°C



5-10
min

Ø 8
mm



POWER UP

No.	W	Ø (mm)	
79385	100	8	25/50

PL Stacja lutownicza
GB Soldering station
D Lötstation
RUS Паяльная станция

CZ Letovací stanice
RO Stație de lipit
H Forrasztópáka állomás
E Estación de soldadura

230V~
50Hz

40
W

150-420
°C



2x
Ø 3.8mm



LUND

No.	W	
79373	40	20

PL Komplet grótw do stacji lutowniczej
GB Spare soldering tips
D Lötspitze
RUS Наконечник паяльника

CZ Hrot do letovačky
RO Vârf pt. ciocanul de lipit
H Pákahegy
E Pico soldador

2
pcs

R1.0 mm
4.2 mm

Ø 3.8 mm
25.5 mm

40
W

420
°C

for/dla:
79373



LUND

No.	W	pcs	for / dla	
79374	40	2	79373	1000

PL Stacja lutownicza
GB Soldering station
D Lötstation
RUS Паяльная станция

CZ Letovací stanice
RO Stație de lipit
H Forrasztópáka állomás
E Estación de soldadura

230V
~50Hz

40
W



150-420
°C

Ø 4.7 mm



STHOR

No.	W	
79376	40	12

PL Komplet grotów do stacji lutowniczej
GB Spare soldering tips
D Lötspitze
RUS Наконечник паяльника

CZ Hrot do letovačky
RO Vârf pt. ciocanul de lipit
H Pákahegy
E Pico soldador

3 pcs
420 °C
for/dla: 79376

∅4.7 mm
56.5 mm

40 W

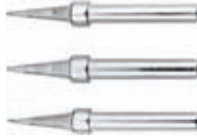

No.	W	pcs	R	for / dla	☐
79377	40	3	0.4; 0.8; 1.2	79376	600
79378	40	3	1.6; 1.6; 3.2	79376	600

PL Stacja lutownicza
GB Soldering station
D Lötstation
RUS Паяльная станция

CZ Letovací stanice
RO Stație de lipit
H Forrasztópáka állomás
E Estación de soldadura

230V ~50Hz
150+420 °C
35(48) W
5 mm



No.	W	☐
79379	35 (48)	8

PL Komplet grotów do stacji lutowniczej
GB Spare soldering tips
D Lötspitze
RUS Наконечник паяльника

CZ Hrot do letovačky
RO Vârf pt. ciocanul de lipit
H Pákahegy
E Pico soldador

3 pcs
420 °C
for/dla: 79379

∅5 mm
50.2 mm

35(48) W



No.	W	pcs	R	for / dla	☐
79380	35 (48)	3	0.4; 0.8; 1.2	79379	400
79381	35 (48)	3	1.6; 1.6; 3.2	79379	400

PL Lutownica pistoletowa
GB Soldering iron
D Delötkolben
RUS Электропаяльник

CZ Pájka odporová
RO Ciocan de lipit
H Huforrasztópáka
E Soldador de resistencia

230V~50Hz
420 °C
40 W
3.8 mm
70 mm



No.	W	☐
79358	40	25/50

PL Lutownica transformatorowa
GB Transformer soldering gun
D Lötpestole
RUS Паяльник электрический

CZ Transformátorová páječka
RO Pistol de lipit
H Forrasztópáka
E Soldador transformador

230V~50Hz
100 W



No.	W	☐
79350	100	24

PL Lutownica transformatorowa
GB Transformer soldering gun
D Lötpestole
RUS Паяльник электрический

CZ Transformátorová páječka
RO Pistol de lipit
H Forrasztópáka
E Soldador transformador

230V~50Hz
100 W



No.	W	☐
79351	100	10

PL Lutownica transformatorowa
GB Transformer soldering gun
D Lötspistole
RUS Паяльник электрический

CZ Transformátorová páječka
RO Pistol de lipit + accesorii
H Forrasztópáka
E Soldador transformador

230V~
50Hz

100 W



STIMOR

No.	W	
79354	100	10

PL Lutownica transformatorowa
GB Transformer soldering gun
D Lötspistole
RUS Паяльник электрический

CZ Transformátorová páječka
RO Pistol de lipit + accesorii
H Forrasztópáka
E Soldador transformador

230V~
50Hz

100 W



LUND

No.	W	
79355	100	10

PL Lutownica transformatorowa
GB Transformer soldering gun
D Lötspistole
RUS Паяльник электрический

CZ Transformátorová páječka
RO Pistol de lipit + accesorii
H Forrasztópáka
E Soldador transformador

230V~
50Hz

200 W



POWERUP

No.	W	
79353	200	10

PL Mieszarka do zapraw
GB Hand mixer
D Mörtelmischgerät
RUS Растворомешалка
CZ Ruční míchačka na maltu
RO Malaxor pt. mortar
H Habarcskeverő
E Mezcladora de mortero

230V~
50Hz

1220 W

0-700
min⁻¹

M14



POWERUP

$L_{pa} = 85,0 \pm 3,0$ dB; $L_{max} = 96,0 \pm 3,0$ dB; $a_v = 2,92 \pm 1,5$ m/s²

No.	W	
78852	1220	2

PL Przecinarka do glazury
GB Tile cutting machine
D Fliesenschnidmaschine
RUS Плиткорез электрический

CZ Stolní řezačka na kachličky
RO Aparat electric pt. talat falanta
H Kezelési utastísa
E Cortadora de gres

230V~
50Hz

600W

2950min⁻¹



0-45°



$L_{pa} = 91,8 \pm 3,0$ dB; $L_{max} = 104,8 \pm 3,0$ dB

No.	W	min-1	Ø (mm)	
79261	600	2950	180	1

PL Szlifierka stolowa
GB Bench grinder
D Doppelschleifmaschine
RUS Станок точильный

CZ Stolní bruska
RO Polizor de banc
H Asztali köszörű
E Lijadera de mesa

230V~
50Hz

120 W

2950min⁻¹



POWERUP

$L_{pa} = 62,6 \pm 3,0$ dB; $L_{max} = 75,6 \pm 3,0$ dB

No.	W	min-1	
79202	120	2950	1

PL Szlifierka stolowa
GB Bench grinder
D Doppelschleifmaschine
RUS Станок точильный

CZ Stolní bruska
RO Polizor de banc
H Asztali kőszűrő
E Lijadera de mesa

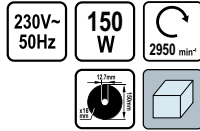

POWERUP

$L_{pA} = 62,6 \pm 3,0$ dB; $L_{wA} = 75,6 \pm 3,0$ dB

No.	W	min-1	
79203	150	2950	1

PL Szlifierka stolowa
GB Bench grinder
D Doppelschleifmaschine
RUS Станок точильный

CZ Stolní bruska
RO Polizor de banc
H Asztali kőszűrő
E Lijadera de mesa

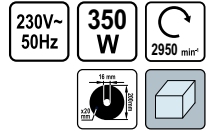

POWERUP

$L_{pA} = 62,6 \pm 3,0$ dB; $L_{wA} = 75,6 \pm 3,0$ dB

No.	W	min-1	
79204	350	2950	1

PL Strugarka grubościowa
GB Planer-thickener
D Dickenhobelmaschine
RUS Рейсмусовый станок
CZ Hoblovka s protahem
RO Mașină de rindeluit la grosime
H Vastagsági gyalu
E Máquina acepilladora de grosor

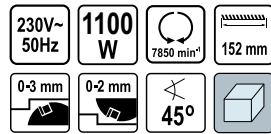

POWERUP

$L_{pA} = 88 \pm 3$ dB; $L_{wA} = 93 \pm 3$ dB

No.	W	min-1	
79285	1100	7850	1

PL Zgrzewarka do rur termoplastycznych
GB PVC plastic pipe welder
D Schweißgerät für thermoplastische Rohre
RUS Сварочная машина для термопластиковых труб
CZ Svářečka na termoplastické trubky
RO Hegesztő berendezés termoplasztikus csövekhez
H Masina de sudat țevl termoplastice
E Máquina de soldar las tubos termoplásticos

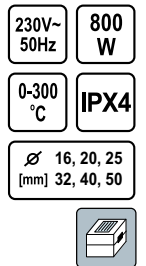

LUND

No.	W	
78911	800	5

PL Zgrzewarka do rur termoplastycznych
GB PVC plastic pipe welder
D Schweißgerät für thermoplastische Rohre
RUS Сварочная машина для термопластиковых труб
CZ Svářečka na termoplastické trubky
RO Hegesztő berendezés termoplasztikus csövekhez
H Masina de sudat țevl termoplastice
E Máquina de soldar las tubos termoplásticos



STWOR

No.	W	
78912	750-1500	4

PL Zgrzewarka do rur termoplastycznych
GB PVC plastic pipe welder
D Schweißgerät für thermoplastische Rohre
RUS Сварочная машина для термопластиковых труб
CZ Svářečka na termoplastické trubky
RO Hegesztő berendezés termoplasztikus csövekhez
H Masina de sudat țevl termoplastice
E Máquina de soldar las tubos termoplásticos

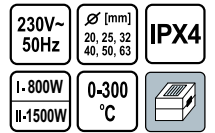

POWERUP

No.	
78910	5

PL Pompa membranowa zatapialna
 GB Membrane deep well water pump
 D Tauchmotorpumpe
 RUS Погружной насос
 CZ Zataovací čerpadlo
 RO Pompă pt. apă cu membrana
 H Bűvárszivattyú
 E Bomba de diafragma sumergible

230V~ 50Hz	300 W	H max 50 m
1/2" 12.5mm	1100 l/h	



No.	W	l / h	
79942	300	1100	4

PL Pompa zatapialna do wody brudnej
 GB Dirty water submersible pump
 D Tauchmotorpumpe
 RUS Погружной насос
 CZ Zataovací čerpadlo
 RO Pompă pt. apă murdară
 H Bűvárszivattyú
 E Bomba de Inmersión para agua sucia

230V~ 50Hz	400 W	H max 5.0 m
5/4" 32mm	6500 l/h	



No.	W	l / h	
79903	400	6500	4

PL Pompa zatapialna do wody brudnej
 GB Dirty water submersible pump
 D Tauchmotorpumpe
 RUS Погружной насос
 CZ Zataovací čerpadlo
 RO Pompă pt. apă murdară
 H Bűvárszivattyú
 E Bomba de Inmersión para agua sucia

230V~ 50Hz	400 W	H max 6.0 m	6000 l/h
1" 25mm	5/4" 32mm	1.5" 38mm	



No.	W	l / h	
79909	400	6000	6

PL Pompa zatapialna do wody brudnej
 GB Dirty water submersible pump
 D Tauchmotorpumpe
 RUS Погружной насос
 CZ Zataovací čerpadlo
 RO Pompă pt. apă murdară
 H Bűvárszivattyú
 E Bomba de Inmersión para agua sucia

230V~ 50Hz	550 W	H max 7.0 m	10000 l/h
1" 25mm	5/4" 32mm	1.5" 38mm	



No.	W	l / h	
79904	550	10000	4

PL Pompa zatapialna do wody brudnej
 GB Dirty water submersible pump
 D Tauchmotorpumpe
 RUS Погружной насос
 CZ Zataovací čerpadlo
 RO Pompă pt. apă murdară
 H Bűvárszivattyú
 E Bomba de Inmersión para agua sucia

230V~ 50Hz	750 W	H max 8.0 m	12500 l/h
1" 25mm	5/4" 32mm	1.5" 38mm	



No.	W	l / h	
79905	750	12500	4

PL Pompa zatapialna do wody brudnej
 GB Dirty water submersible pump
 D Tauchmotorpumpe
 RUS Погружной насос
 CZ Zataovací čerpadlo
 RO Pompă pt. apă murdară
 H Bűvárszivattyú
 E Bomba de Inmersión para agua sucia

230V~ 50Hz	900 W	H max 9.0 m	14000 l/h
1" 25mm	5/4" 32mm	1.5" 38mm	



No.	W	l / h	
79906	900	14000	4

- PL Pompa zatapialna do wody brudnej
 GB Dirty water submersible pump
 D Tauchmotorpumpe
 RUS Погружной насос
 CZ Zataňovací řerpadlo
 RO Pompă pt. apă murdară
 H Bűvárszivattyú
 E Bomba de inmersión para agua sucia

230V~ 50Hz	1100 W	H max 10 m	15000 l/h
1" 25 mm	5/4" 32 mm	1.5" 38 mm	



POWERUP

No.	W	l / h	H (max)	
79907	1100	15000	10	4

- PL Pompa zatapialna do wody brudnej
 GB Dirty water submersible pump
 D Tauchmotorpumpe
 RUS Погружной насос
 CZ Zataňovací řerpadlo
 RO Pompă pt. apă murdară
 H Bűvárszivattyú
 E Bomba de inmersión para agua sucia

230V~ 50Hz	1" 25 mm
5/4" 32 mm	1.5" 38 mm



FLO

No.	W	l / h	H (max)	
79890	400	7500	5	4
79891	550	10500	7	4
79892	750	13000	9	2
79893	900	14000	10	2
79894	1100	15000	11	2

- PL Pompa zatapialna do wody brudnej
 GB Dirty water submersible pump
 D Tauchmotorpumpe
 RUS Погружной насос
 CZ Zataňovací řerpadlo
 RO Pompă pt. apă murdară
 H Bűvárszivattyú
 E Bomba de inmersión para agua sucia

230V~ 50Hz	1" 25 mm
5/4" 32 mm	1.5" 38 mm
INOX	



FLO

No.	W	l / h	H (max)	
79896	550	12500	8	2
79897	750	13000	9	2
79898	900	14500	10	2
79899	1100	15500	11	2

- PL Pompa zatapialna do wody brudnej
 GB Dirty water submersible pump
 D Tauchmotorpumpe für schmutzwasser
 RUS Погружной насос для грязной воды
 CZ Ponomé řerpadlo na špinavú vodu
 RO Pompa submersibilă pt. apă murdară
 H Bűvárszivattyú
 E Bomba sumergible para aguas sucias

230V~ 50Hz	450 W	
---------------	----------	--



FLO

No.	W	l / h	H (max)	
79880	450	16000	9	1

- PL Pompa zatapialna do wody brudnej
 GB Dirty water submersible pump
 D Tauchmotorpumpe für schmutzwasser
 RUS Погружной насос для грязной воды
 CZ Ponomé řerpadlo na špinavú vodu
 RO Pompa submersibilă pt. apă murdară
 H Bűvárszivattyú
 E Bomba sumergible para aguas sucias

230V~ 50Hz	750 W	
CUTTING SYSTEM		
SYSTEM TNACY		



FLO

No.	W	l / h	H (max)	
79883	750	16000	13	1

- PL Pompa ogrodowa
 GB Jet pump
 D Gartenpumpe
 RUS Насос садовый
- CZ Zahradní řerpadlo
 RO Pompa apa
 H Kerti szivattyúhoz
 E Bomba de jardin con cabeza

230V~ 50Hz	
---------------	--



FLO

$L_{pA} = 67,5 \pm 3,0$ dB; $L_{wA} = 78,5 \pm 3,0$ dB

No.	W	l / h	H (max)	max. pressure / max. ciñnienie (bar)	
79912	600	2800	35	3.5	1
79913	800	3200	40	4.0	1
79914	1000	3500	44	4.4	1

PL Pompa fontanna
 GB Fountain pump
 D Springbrunnenpumpe
 RUS Фонтанный насос
 CZ Fontánová pumpa
 RO Pompa pt. fantana arteziana
 H Pumpa szökőkúthoz
 E Bomba para las fuentes



No.	W	l / h	H (max)	
79926	8	600	1.0	12
79927	16	800	1.3	12
79928	22	1000	1.6	12

PL Pompa fontanna
 GB Fountain pump
 D Springbrunnenpumpe
 RUS Фонтанный насос
 CZ Fontánová pumpa
 RO Pompa pt. fantana arteziana
 H Pumpa szökőkúthoz
 E Bomba para las fuentes



No.	W	l / h	H (max)	
79929	28	1400	2.0	8
79930	40	1800	2.5	8

PL Pompa fontanna
 GB Fountain pump
 D Springbrunnenpumpe
 RUS Фонтанный насос
 CZ Fontánová pumpa
 RO Pompa pt. fantana arteziana
 H Pumpa szökőkúthoz
 E Bomba para las fuentes



No.	W	l / h	H (max)	
79931	55	2000	2.5	8
79932	85	3000	3.5	8
79933	100	4500	4.5	6

PL Podkaszarka elektryczna
 GB Electric grass trimmer
 D Elektrische Untergrasmaschine
 RUS Триммер электрический
 CZ Elektrická sekačka na trávu
 RO Cositoare pt. iarba
 H Elektromos fűnyíró
 E Segadora



$L_{pa} = 82,3 \pm 3,0$ dB; $L_{ma} = 91,8 \pm 2,29$ dB; $a_n = 4,549 \pm 1,5$ m/s²

No.	W	min-1	Ø (mm)	
79456	250	14000	200	6/12

PL Podkaszarka elektryczna
GB Electric trimmer
D Elektro-Rasentrimmer
RUS Электрический триммер
CZ Elektrická sekačka
RO Costoare electrică
H Elektromos fűnyíró
E Segadora eléctrica



230V~50Hz 500 W
10500 min⁻¹ 280 mm
↑100 cm ↓80 cm 2 POSITIONS POZYCJE

$L_{pa} = 74,4 \pm 1,94$ dB; $L_{wa} = 94,1 \pm 1,94$ dB; $a_h = 0,794 \pm 1,5$ m/s²

No.	W	min-1	Ø (mm)	☐
79467	500	10500	280	4

PL Elektryczne nożyce do żywoplotu
GB Hedge shears
D Heckenscheren
RUS Ножницы для живой изгороди
CZ Nůžn CD alyé SčW
RO Foarfece pt. gard viu
H Sövényvágó olló
E Tijera para vallado



230V~50Hz 450 W 1700min⁻¹
410mm

$L_{pa} = 81,6 \pm 3$ dB; $L_{wa} = 101,6 \pm 3$ dB; $a_h = 5,328 \pm 1,5 / 6,1214 \pm 1,5$ m/s²

No.	W	min-1	L (mm)	☐
79442	450	1700	410	4

PL Nożyce do żywoplotu
GB Hedge shears
D Heckenscheren
RUS Ножницы для живой изгороди
CZ Nůžn CD alyé SčW
RO Foarfece pt. gard viu
H Sövényvágó olló
E Tijera para vallado



230V~50Hz 520 W 1600min⁻¹ 510mm

$L_{pa} = 75,2 \pm 0,6$ dB; $L_{wa} = 95,2 \pm 0,6$ dB; $a_h = 2,840 \pm 1,5$ m/s²

No.	W	min-1	L (mm)	☐
79444	520	1600	510	4

PL Nożyce do żywoplotu
GB Hedge shears
D Heckenscheren
RUS Ножницы для живой изгороди
CZ Nůžn CD alyé SčW
RO Foarfece pt. gard viu
H Sövényvágó olló
E Tijera para vallado



230V~50Hz 550 W 1700min⁻¹ 510mm

$L_{pa} = 78,58 \pm 1,489$ dB; $L_{wa} = 98,54 \pm 1,489$ dB; $a_h = 3,272 \pm 1,5 / 3,435 \pm 1,5$ m/s²

No.	W	min-1	L (mm)	☐
79448	550	1700	510	4

PL Przyłącze do węży do pomp zatapialnych
GB Hose connection
D Druckleitung-Anschlussstütze
RUS Соединитель для шланга
CZ Koleno k hadici
RO Ștuț de fixare furtun
H Tömő csatlakozó
E Tubuladura para manguera para bombas de Inmersiyn



G 1.5" for: dla: 79903 79907
G 38mm 79904 79921
79905 79923
79906

POWER UP

No.	☐
79919	100

PL Komplet tarcz do pilarki dwutarczowej
GB Set of discs for double-disc sawing machines
D Sägeblattsatz für eine Zweischeibensäge
RUS Комплект дисков для двухдисковой пилы
CZ Sada kotoučů pro dvoukotoučovou pilu
RO Set de discuri pt. ferăstrău cu două discuri
H Társcakészlet két tárcsás fűrészhez
E Juego de discos para máquina de serrar de dos discos



2 PCS 32T
125x16x1.6
125x28x1.6 [mm]

for/dla: 79255

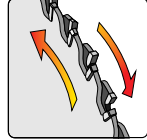

POWER UP

No.	Ø (mm)	for / dla	pcs	☐
79256	125x16x1.6; 125x28x1.6	79255	2	50

- PL Głowica do wiertarki samozaciskowej
 GB Drill chuck
 D Schnellspanbohrfutter
 RUS Патрон для дрели быстрозажимной
 CZ Hlava na vrtáčku samosvorná
 RO Mandrină cu autostrângere pt. bormașină
 H Az önbeszorulás fűrésztokmányfej
 E Cabeza para taladradora autoapriete



No.	Ø (mm)	size / rozmiar	
79570	1-10	3/8" (10.0 mm)	10/50
79572	1-10	1/2" (12.5 mm)	10/50

- PL Głowica do wiertarki samozaciskowej
 GB Drill chuck
 D Schnellspanbohrfutter
 RUS Патрон для дрели быстрозажимной
 CZ Hlava na vrtáčku samosvorná
 RO Mandrină cu autostrângere pt. bormașină
 H Az önbeszorulás fűrésztokmányfej
 E Cabeza para taladradora autoapriete



No.	Ø (mm)	size / rozmiar	
79580	2-13	1/2" (12.5 mm)	5/40

- PL Głowica do wiertarki na klucz
 GB Drill chuck
 D Schnellspanbohrfutter
 RUS Патрон для дрели зубчатый

- CZ Hlava na vrtáčku na klíč
 RO Mandrină cu cheie pt. bormașină
 H Az önbeszorulás fűrésztokmányfej
 E Cabeza para taladradora de llave



No.	Ø (mm)	size / rozmiar	
79600	1.5-10	3/8" (10.0 mm)	10/50
79620	1.5-10	1/2" (12.5 mm)	10/50
79630	1.5-13	1/2" (12.5 mm)	5/40

- PL Adapter SDS-plus - UNF 1/2"
 GB Adapter SDS-plus - UNF 1/2"
 D Adapter SDS-plus - UNF 1/2"
 RUS Переходник с SDS плюс на 1/2 дюйма
 CZ Přenoska SDS-plus - UNF 1/2"
 RO Adaptor SDS-plus - UNF 1/2"
 H SDS-plus adapter - UNF 1/2"
 E Adaptor SDS-plus - UNF 1/2"



No.	size / rozmiar	
79800	1/2" (12.5 mm)	12/144

- PL Statyw do szlifierek kątowych
 GB Angle grinder stand
 D Winkelschleif-Trennstander
 RUS Штатив

- CZ Stojan pro úhlovou brusku
 RO Stativ pt. polizor unghiular
 H Állvány sarokcsiszolóhoz
 E Soporte para lijadora de ángulo



No.	
79641	4

- PL Stojak do wiertarki
 GB Drill stand
 D Bohrmachinesänder
 RUS Сверлильная станция
 CZ Stativ do vrtáčky
 RO Suport masina de gaurit
 H Fűrészállvány
 E Soporte para taladro



No.	h (mm)	
79640	400	10

- PL Zapasowe ostrza do struga elektrycznego
 GB Spare cutting knife for electric planer
 D Hobelmesser für Elektrohubel
 RUS Лезвия для электрорубанка
 CZ Náhradní nůž SUR-HBNAJ KREOMX
 RO Lamă de rezervă pt. rindea electrică
 H Tartalék gyalukés elektromos gyalugéphez
 E Filos de repuesto para cepillo eléctrico

2
PCS



No.	pcs packing	
79346	2	30/360

- PL Kamienie szlifierskie trzpieniowe
 GB Mounted stone set
 D Schleifsteinaufsätze
 RUS Набор абразивных наконечников

- CZ Brusné kameny hrotové
 RO Set pietre abrazive cu tija
 H Csiszolókészlet, csapszárú
 E Discos de esmeril

5
PCS

6
Ømm

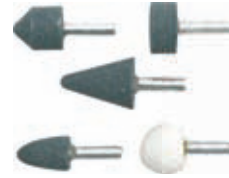

No.	Ø (mm)	pcs	
25400	6	5	25/200

- PL Tarniki trzpieniowe
 GB Rotary file set
 D Raspelaufsatz
 RUS Набор металллических бор-фрез

- CZ Hrotové rašple
 RO Set raspile cu tija
 H Fareszélkészlet, csapszárú
 E Escofinas

5
PCS

6
Ømm



No.	Ø (mm)	pcs	
25450	6	5	25/200

- PL Zestaw końcówek do szlifierki
 GB Mini grinder accessories set
 D Schleifaufsätze
 RUS Набор шлифовальных и полировочных насадок для арт.79316

- CZ Soustava koncovek na brusku
 RO Set pietre abrazive si pasla pt. slefuit
 H Fejkészlet csiszológéphez
 E Juego de puntas de pulir

13
PCS



No.	pcs	
25410	13	10/50

- PL Zestaw końcówek do szlifierki
 GB Mini grinder accessories set
 D Schleifaufsätze
 RUS Набор шлифовальных и полировочных насадок для арт.79316

- CZ Soustava koncovek na brusku
 RO Set pietre abrazive si pasla pt. slefuit
 H Fejkészlet csiszológéphez
 E Juego de puntas de pulir

17
PCS



No.	pcs	
25411	17	10/50

- PL Zestaw końcówek do szlifierki
 GB Mini grinder accessories set
 D Schleifaufsätze
 RUS Набор шлифовальных и полировочных насадок для арт.79316

- CZ Soustava koncovek na brusku
 RO Set pietre abrazive si pasla pt. slefuit
 H Fejkészlet csiszológéphez
 E Juego de puntas de pulir

22
PCS



No.	pcs packing	
25412	22	10/50

- PL Nasadki polerujące
 GB Polishing covers
 D Polierscheibe
 RUS Полировочные накладки

- CZ Leštící kotouč
 RO Polizor captusit
 H Polírozó korong
 E Fundas

2
PCS

Ø [mm]
245

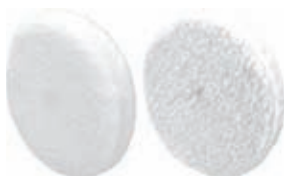

No.	Ø (mm)	for / dla	pcs packing	
82941	245	82940	2	10/100

- PL Zestaw „trzecia ręka”
 GB Helping hand with magnifying glass
 D Hilfhand mit Lupe
 RUS Комплект „третья рука” с лупой
 CZ Sada „třetí ruka”
 RO Ceva cu lupa
 H Panelartó állvány „harmadik kéz”
 E Juego „la tercera mano” con lupa



No.	glass / szkło Ø (mm)	
73500	62	10/40

PL Stojak do lutownicy
GB Soldering iron stand
D LötKolbenständer
RUS Подставка для паяльника

CZ Stojan na pájku
RO Suport pt. cloacan lipit
H Forrasztópáka tartó
E Caballete de soldador



No.	pcs
79386	50

PL Podstawka do lutownicy
GB Soldering iron stand
D LötKolbenständer
RUS Подставка для паяльника

CZ Stojan na pájku
RO Suport pt. cloacan lipit
H Forrasztópáka tartó
E Caballete de soldador



No.	pcs
79387	50

PL Podstawka do lutownicy
GB Soldering iron stand
D LötKolbenständer
RUS Подставка для паяльника

CZ Stojan na pájku
RO Suport pt. cloacan lipit
H Forrasztópáka tartó
E Caballete de soldador



No.	pcs
79389	50/500

PL Spoiwo lutownicze
GB Solder
D Lötzin
RUS Припой

CZ Pájka
RO Sarma de sudura
H Forrasztó ón
E Estano plata

Sn60
Pb40



No.	Ø (mm)	weight / waga (g)	pcs
76800	0.5	100	60
76801	0.5	250	40
76806	0.7	100	60
76807	0.7	250	40
76810	1.0	100	60
76811	1.0	250	40
76812	1.0	500	20
76814	1.5	100	60
76815	1.5	250	40
76816	1.5	500	20
76818	2.0	100	60
76819	2.0	250	40
76820	2.0	500	20
76822	2.5	100	60
76823	2.5	250	40
76824	2.5	500	20
76826	3.0	100	60
76827	3.0	250	40
76828	3.0	500	20

PL Zestaw narzędzi lutowniczych
GB Soldering accessories
D Lötzubehör
RUS Принадлежности для пайки

CZ Pájeci příslušenství
RO Accesorii de lipit
H Forrasztó tartozékok
E Jooteseadmed tarvikud

6
PCS

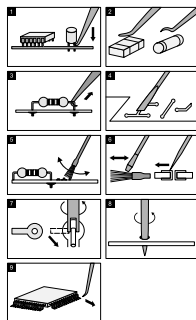
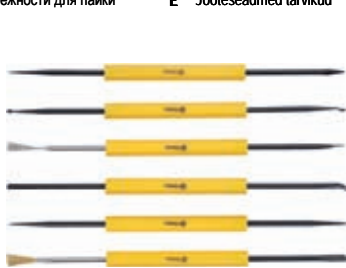

No.	pcs	pcs
79398	6	25/100

PL Spoiwo lutownicze
GB Solder
D Lötzin
RUS Припой

CZ Pájka
RO Sarma de sudura
H Forrasztó ón
E Estano plata

Sn60
Pb40



No.	Ø (mm)	weight / waga (g)	pcs
76830	1.0	16	25/500

PL Pasta lutownicza
GB Solder paste
D Lotpaste
RUS Паяльная паста

CZ Pájeci pasty
RO Pasta decapante sudura
H Forrasztó paszta
E Pasta de soldar



No.	weight / waga (g)	pcs
76835	40	50

PL Cyna w lasce
GB Solder stick
D Stangenlotzinn
RUS Припой

CZ Pájka v tyčkách
RO Baghete de sudura
H Forrasztó rúd
E Barra estaño plomo

Sn60
Pb40



No.	dimensions / wymiary (mm)	weight / waga (kg)	
76832	7x7x322	5	1

PL Kalafonia lutownicza
GB Rosin
D Kolophonium
RUS Канифоль

CZ Kalafuna
RO Colofoniu
H Forrasztó gyanta
E Colofonia



No.	weight / waga (g)	
76836	45	50

PL Odsyszac do cyny
GB Desoldering pump
D Entlötsaugpumpe
RUS Шприц для удаления припоя

CZ Odpájecí sací pumpa
RO Pompa fluidor
H Ónszippantó
E Bomba desoldadora

PTFE
TIP



No.	
79390	100/400

PL Odsyszac do cyny
GB Desoldering pump
D Entlötsaugpumpe
RUS Шприц для удаления припоя

CZ Odpájecí sací pumpa
RO Pompa fluidor
H Ónszippantó
E Bomba desoldadora

PTFE
TIP



No.	
79391	70/140

PL Opaska antystatyczna
GB Antistatic wrist strap
D Antistatisches Armband
RUS Браслет антистатический

CZ Pásek antistatický
RO Curea antistatica
H Antisztatikus csuklópánt
E Pulsera antiestatica



No.	
79395	100

PL Wąż tłoczny do motopomp z końcówkami
GB Pumping hose for motor pumps with terminals
D Druckschlauch für Motorpumpen mit Anschlussstücken
RUS Напорный рукав для мотопомп с наконечниками
CZ Vytlačná hadice s koncovkami pro motorová čerpadla
RO Furtun pt. motorpompe cu capete
H Szivattyú nyomótömlő kapcsokkal szerelve
E Manguera para bombear para motobombas con terminales



No.	L (m)	Ø	max. working pressure / max. ciśnienie robocze (bar)	bursting pressure / ciśnienie rozrywające (bar)	
79977	20	2" (50 mm)	6	24	1
79978	20	3" (75 mm)	6	24	1
79979	20	4" (100 mm)	6	24	1

PL Wąż tłoczny do motopomp
GB Pumping hose for motor pumps
D Druckschlauch für Motorpumpen
RUS Напорный рукав для мотопомп

CZ Vytlačná hadice pro motorová čerpadla
RO Furtun pt. motorpompe
H Szivattyú nyomótömlő
E Manguera para bombear para motobombas



No.	L (m)	Ø	max. working pressure / max. ciśnienie robocze (bar)	bursting pressure / ciśnienie rozrywające (bar)	
79982	50	1" (25 mm)	2	6	1
79983	50	2" (50 mm)	2	6	1
79984	50	3" (75 mm)	2	6	1

PL Nasada Storz z gwintem wewnętrznym
GB Storz attachment with internal thread
D Aufsatzarmatur mit Innengewinde wg Storz
RUS Гайка Шторца с внутренней резьбой

CZ Adaptér Storz s vnitřním závitem
RO Racord Storz cu filet interior
H Csonkkapocs belső menetes
E Boquilla Storz con rosca interna



No.	Ø	bursting pressure / ciśnienie rozrywające (bar)	
79990	2" (50 mm)	48	1
79991	3" (75 mm)	48	1
79992	4" (100 mm)	48	1

16

Welding equipment Sprzęt spawalniczy

Welding machines
Spawarki

222

Welding accessories
Akcesoria spawalnicze

222-225

Electrodes & welding wires

Elektrody i druty do spawania..... 222

Clamps

Zaciski spawalnicze..... 222

Welding goggles & masks



Okulary i maski spawalnicze..... 222

Lock grip pliers

Szczypce zaciskowe..... 225

PL Spawarka inwerterowa
GB Inverter welder
D Inverter-Schweißanlage
RUS Инверторный сварочный аппарат
CZ Svářečka inverterová
RO Invertor sudura
H Hegesztő trafo
E Soldadora de inversión

230V~
50 Hz
 IGBT
 140A
 POWER GENERATOR SURPLY
MOŻLIWOŚĆ STABILIZACJA ŁUKU
 ARC FORCE STABILIZACJA ŁUKU
 DUTY CYCLE CYKL PRACY
60%
 ELECTRODE SIZE ROZMIAR ELEKTRODY
1.6-3.2 mm
 PROTECTION GRADE STOPNIEN OCHRONY
IP21S
 WINDING POLYESTEROWY
KLASA IZOLACJI UZWIĘZIENIA
F





POWERUP

No.	A	
73200	140	2

PL Spawarka inwerterowa
GB Inverter welder
D Inverter-Schweißanlage
RUS Инверторный сварочный аппарат
CZ Svářečka inverterová
RO Invertor sudura
H Hegesztő trafo
E Soldadora de inversión

230V~
50 Hz
 IGBT
 160 A
 POWER GENERATOR SURPLY
MOŻLIWOŚĆ STABILIZACJA ŁUKU
 ARC FORCE STABILIZACJA ŁUKU
 DUTY CYCLE CYKL PRACY
60%
 ELECTRODE SIZE ROZMIAR ELEKTRODY
1.6-4 mm
 PROTECTION GRADE STOPNIEN OCHRONY
IP21S
 WINDING POLYESTEROWY
KLASA IZOLACJI UZWIĘZIENIA
F

POWERUP

No.	A	
73201	160	2

PL Elektrody rutyłowe
GB Welding electrodes
D Rutillstabelektroden
RUS Сварочный электрод
CZ Elektrody
RO Electrozi pt. sudura
H Elektrodák
E Electrodo



No.	Ø (mm)	L (mm)	kg	
74307	2.5	350	4	1
74311	3.2	450	5	1
74316	4.0	450	6	1

PL Drut spawalniczy
GB Welding wire
D Fühlraht
RUS Сварочная проволока стальная
CZ Drát svařovací
RO Sarmă pt. sudura
H Forrasztó ón
E Alambre de soldado



No.	Ø (mm)	kg	
74255	0.8	5	1

PL Zacisk spawalniczy kleszczowy
GB Clamp
D Schweisseklemme
RUS Клещи для сварки
CZ Kleště svářečské zemnicí
RO Clește pt. sudura
H Testkábel-csatlakozó
E Coccodrilo para soldar



No.	type	
74420	ZBK-35	25
74421	ZBK-70	25
74422	ZBK-95	25

PL Uchwyt spawalniczy elektrodowy
GB Electrode holder
D Schweisselectrodengriff
RUS Клещи для сварки (электродные)
CZ Uchvat NĚMURG
RO Clește pt. sudura cu electrod
H Elektrodafogó
E Abrazadera para soldar, de electrodos



No.	type	
74430	UE-200	25
74431	UE-300	25
74432	UE-400	25

PL Okulary spawalnicze
GB Welding goggles
D Schweisserbrille
RUS Очки газосварщика
CZ Brýle svářečské
RO Ochelari pt. sudura
H Hegesztőszemüveg
E Gafas para soldar



VOREL

No.	
74400	25/100

PL Okulary spawalnicze
GB Welding goggles
D Schweisserbrille
RUS Очки газосварщика
CZ Brýle svářečské
RO Ochelari pt. sudura
H Hegesztőszemüveg
E Gafas para soldar



No.	
74410	5/100

PL Okulary spawalnicze
GB Welding goggles
D Schweisserbrille
RUS Очки газосварщика

CZ Brýle svářečské
RO Ochelari pt. sudură
H Hegesztőszeműveg
E Gafas para soldar



No.



74411

10/100

PL Maska spawalnicza
GB Welding mask
D Schweissermaske
RUS Щиток сварщика
CZ Svářečská maska
RO Mască de sudură
H Hegesztőpajzs
E Mascara de soldador



No.

type



74440

TSM-3

30

PL Maska spawalnicza
GB Welding mask
D Schweissermaske
RUS Щиток сварщика
CZ Svářečská maska
RO Mască de sudură
H Hegesztőpajzs
E Mascara de soldador



No.

type



74442

TSM

30

PL Maska spawalnicza
GB Welding mask
D Schweissermaske
RUS Щиток сварщика
CZ Svářečská maska
RO Mască de sudură
H Hegesztőpajzs
E Mascara de soldador



No.

type



74443

TSM

20

PL Maska spawalnicza
GB Welding mask
D Schweissermaske
RUS Щиток сварщика
CZ Svářečská maska
RO Mască de sudură
H Hegesztőpajzs
E Mascara de soldador



No.

type



74450

TSD-3

20

PL Przyłbica spawalnicza z podględem
GB Welding mask
D Schweissermaske
RUS Щиток сварщика с подсмотром

CZ Svářečská přilba s nakoukáváním
RO Mască de sudură cu geam
H Hegesztősisak kitékintővel
E Mascara de soldador con mirador



No.

type



74447

PSMP

20

PL Przyłbica spawalnicza z podględem
GB Welding mask
D Schweissermaske
RUS Щиток сварщика с подсмотром

CZ Svářečská přilba s nakoukáváním
RO Mască de sudură cu geam
H Hegesztősisak kitékintővel
E Mascara de soldador con mirador



No.

type



74448

PS-3

10

PL Maska spawalnicza
GB Welding mask
D Schweissermaske
RUS Щиток сварщика
CZ Svářečská maska
RO Mască de sudură
H Hegesztőpajzs
E Mascara de soldador



No.



74441

20

PL Przyłbica spawalnicza
GB Welding mask
D Schweißsmaske
RUS Щиток сварщика

CZ Svářečská přilba s nakoukáváním
RO Mască de sudură cu geom
H Hegesztőlásak kitékinővel
E Mascara de soldador con mirador



No.	
74457	20

PL Przyłbica spawalnicza samościemniająca
GB Auto-darkening welding helmet
D Schweißsmaske, selbstverdunkelnd
RUS Маска для сварки, самостоятельно затемняющаяся
CZ Svářečská kukla samostmívaci
RO Mască de sudură auto-întunecare
H Önmagától sötétedő hegesztőpajzs
E Casco auto-oscurecedor para soldadura

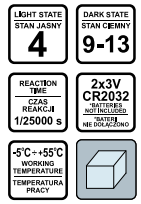

No.	
74435	6

PL Przyłbica spawalnicza samościemniająca
GB Auto-darkening welding helmet
D Schweißsmaske, selbstverdunkelnd
RUS Маска для сварки, самостоятельно затемняющаяся
CZ Svářečská kukla samostmívaci
RO Mască de sudură auto-întunecare
H Önmagától sötétedő hegesztőpajzs
E Casco auto-oscurecedor para soldadura

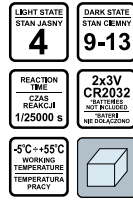

No.	
74436	6

PL Przyłbica spawalnicza samościemniająca
GB Auto-darkening welding helmet
D Schweißsmaske, selbstverdunkelnd
RUS Маска для сварки, самостоятельно затемняющаяся
CZ Svářečská kukla samostmívaci
RO Mască de sudură auto-întunecare
H Önmagától sötétedő hegesztőpajzs
E Casco auto-oscurecedor para soldadura

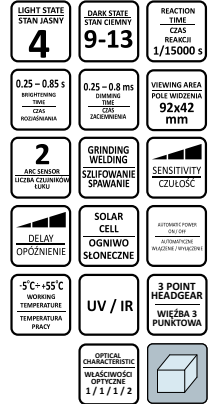

No.	
74480	6

PL Przyłbica spawalnicza samościemniająca
GB Auto-darkening welding helmet
D Schweißsmaske, selbstverdunkelnd
RUS Маска для сварки, самостоятельно затемняющаяся
CZ Svářečská kukla samostmívaci
RO Mască de sudură auto-întunecare
H Önmagától sötétedő hegesztőpajzs
E Casco auto-oscurecedor para soldadura

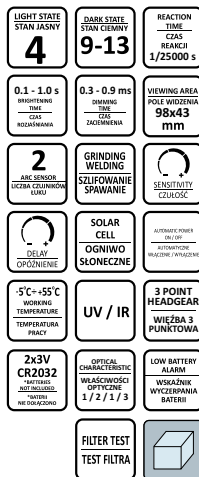

No.	
74481	6

PL Przyłbica spawalnicza samościemniająca
GB Auto-darkening welding helmet
D Schweißsmaske, selbstverdunkelnd
RUS Маска для сварки, самостоятельно затемняющаяся
CZ Svářečská kukla samostmívaci
RO Mască de sudură auto-întunecare
H Önmagától sötétedő hegesztőpajzs
E Casco auto-oscurecedor para soldadura

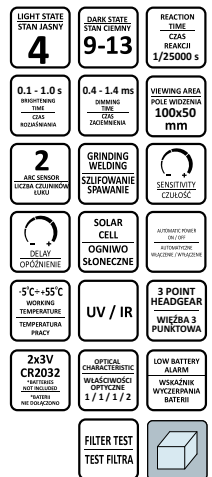

No.	
74482	6

- PL Przyłbica spawalnicza CZ Svářečská maska
 GB Welding helmet RO Mască de sudură
 D Schweißermaske H Hegesztőpajzs
 RUS Щиток сварщика E Mascara de soldador



VOREL

No.	mm	type	pcs
74449			12

- PL Osłona filtra CZ Ochrana filtru
 GB Filter shield RO Apărătoare de filtru
 D Filterabdeckung H Szűrőfedél
 RUS Кофух фильтра E Protección de filtro



No.	mm	type	pcs
74451	50x100	E-0	150

- PL Filtr spawalniczy CZ Filtr svářečský
 GB Welding filter RO Filtru pt. sudură
 D Vorsatzglas H Hegesztőszűrő
 RUS Фильтр для сварки E Pantalla de filtro de soldador



No.	mm	type	pcs
74452	50x100	E-8	100
74453	50x100	E-9	100
74454	50x100	E-10	100
74455	50x100	E-11	100
74456	50x100	E-12	100

- PL Osłona filtra przyłbicy samościemniającej CZ Ochranná folie filtru samostmívající kukly
 GB Self-dimming helmet filter protection RO Carcasă filtru vizieră hellomată
 D Filtereinsatz eines selbstabdunkelnden Schutzhelms H Hegesztőpajzs szűrő, önsötétedő
 RUS Кофух фильтра самозатемняющегося щитка E Protección del filtro de visera autooscurecedora



No.	mm	pcs	pcs
74439	90x110	5	20

- PL Szczypce spawalnicze CZ Svářečské kleště
 GB Lock grip pliers RO Clește autoblocant pt. sudura
 D Schweißserzange H Hegesztő fogó
 RUS Ключ - зажим E Alicates de soldar



No.	L (mm)	type	pcs
44300	275	C	6/36

- PL Szczypce zaciskowe klamrowe typu „C” CZ Kleště samosvorné upínací typu „C”
 GB Welding locking pliers „C” type RO Clește de strângere cu clemă tip „C”
 D Klemm- und Klammerzange vom Typ „C” H „C” fogó
 RUS Клещи давяльные типа „С” E Pinzas de tornillo (de apriete) de grapa tipo „C”



VOREL

No.	L (mm)	type	pcs
44301	280	C	6/30

- PL Szczypce spawalnicze CZ Svářečské kleště
 GB Lock grip pliers RO Clește autoblocant pt. sudura
 D Schweißserzange H Hegesztő fogó
 RUS Ключ - зажим E Alicates de soldar



No.	L (mm)	type	pcs
44400	225	W	6/36

- PL Szczypce spawalnicze CZ Svářečské kleště
 GB Lock grip pliers RO Clește autoblocant pt. sudura
 D Schweißserzange H Hegesztő fogó
 RUS Ключ - зажим E Alicates de soldar



No.	L (mm)	type	pcs
44500	250	SM	6/36

17

Safes, padlocks & locks
Sejfy, kłódki i zamki

Safes
Sejfy

228

**Key boxes**
Skrzynki na klucze

228

**Cash boxes**
Kasetki na pieniądze

228-229

**Padlocks**
Klódki

229-231

**Cast iron padlocks**
Klódki żeliwne.....

229

Brass padlocks
Klódki mosiężne.....

230

Lock cylinders & bodies
Wkładki do zamków i zamki

231-237

**Brass lock cylinders**
Wkładki mosiężne.....

231

Door locks
Zamki do drzwi.....

232

Bolts & safety chains
Zasuwki i łańcuchy do drzwi.....

235

Door closers
Samozamykacze.....

237

Door peep holes
Wizjery.....

237

Bicycle & motorcycle locks
Zamknięcia do rowerów i motocykli

238-239



PL Sejf z zamkiem cyfrowym
GB Safe with digital lock
D Seif mit Digitalschloss
RUS Сейф с электронным замком

CZ Panceřová pokladna z digitálním zámkem
RO Seif cu broasca cu cifru
H Számzáras széf
E Caja de seguridad con cerradura digital



No.	cm	
78641	35x25x25	1

PL Sejf z zamkiem cyfrowym
GB Safe with digital lock
D Seif mit Digitalschloss
RUS Сейф с электронным замком

CZ Panceřová pokladna z digitálním zámkem
RO Seif cu broasca cu cifru
H Számzáras széf
E Caja de seguridad con cerradura digital



No.	cm	
78642	31x20x20	1

PL Skrzynka na klucze
GB Key box
D Schlüsselkasten
RUS Ящик для ключей
CZ Skříňka na klíče
RO Cutie pt. chei
H Kulcstartó doboz
E Caja para llaves

200x160x78
mm

2x 15x
HOOKS
HACZYKÓW



No.	size / rozmiar (mm)	
78432	200x160x78	20

PL Skrzynka na klucze
GB Key box
D Schlüsselkasten
RUS Ящик для ключей

CZ Skříňka na klíče
RO Cutie pt. chei
H Kulcstartó doboz
E Caja para llaves

250x180x80
mm

2x 48x
HOOKS
HACZYKÓW



No.	size / rozmiar (mm)	
78434	250x180x80	10

PL Skrzynka na klucze
GB Key box
D Schlüsselkasten
RUS Ящик для ключей

CZ Skříňka na klíče
RO Cutie pt. chei
H Kulcstartó doboz
E Caja para llaves

450x380x80
mm

2x 80x
HOOKS
HACZYKÓW



No.	size / rozmiar (mm)	
78436	450x380x80	5

PL Kasetka na pieniądze
GB Cash box
D Geldkassette
RUS Ящик для денег
CZ Kazeta na peníze
RO Casetă (cutie) pt. bani
H Pénzes kazetta
E Caja para efectivo

150x120x80
mm

2x



No.	size / rozmiar (mm)	colour / kolor	
78620	150x120x80		20
78621	150x120x80		20
78611	150x120x80		20

PL Kasetka na pieniądze
GB Cash box
D Geldkassette
RUS Ящик для денег
CZ Kazeta na peníze
RO Casetă (cutie) pt. bani
H Pénzes kazetta
E Caja para efectivo

200x160x90
mm

2x



No.	size / rozmiar (mm)	colour / kolor	
78622	200x160x90		10
78623	200x160x90		10
78612	200x160x90		10

PL Kasetka na pieniądze
GB Cash box
D Geldkassette
RUS Ящик для денег
CZ Kazeta na peníze
RO Casetă (cutie) pt. bani
H Pénzes kazetta
E Caja para efectivo

200x160x90
mm

CODE
SZYFR



No.	size / rozmiar (mm)	colour / kolor	
78624	200x160x90		10
78613	200x160x90		10

PL Kasetka na pieniádze
 GB Cash box
 D Geldkassette
 RUS Ящик для денег
 CZ Kasetka na peníze
 RO Casetá (cutie) pt. bani
 H Pénzes kassetta
 E Caja para efectivo

250x200x90
mm

2x



No.	size / rozmiar (mm)	colour / kolor	
78626	250x200x90		10
78627	250x200x90		10
78614	250x200x90		10

PL Kasetka na pieniádze
 GB Cash box
 D Geldkassette
 RUS Ящик для денег
 CZ Kasetka na peníze
 RO Casetá (cutie) pt. bani
 H Pénzes kassetta
 E Caja para efectivo

250x180x90
mm

CODE
SZYFR



No.	size / rozmiar (mm)	colour / kolor	
78628	250x180x90		10
78615	250x180x90		10

PL Kasetka na pieniádze
 GB Cash box
 D Geldkassette
 RUS Ящик для денег
 CZ Kasetka na peníze
 RO Casetá (cutie) pt. bani
 H Pénzes kassetta
 E Caja para efectivo

300x240x90
mm

2x



No.	size / rozmiar (mm)	colour / kolor	
78630	300x240x90		10
78616	300x240x90		10

PL Kasetka na pieniádze
 GB Cash box
 D Geldkassette
 RUS Ящик для денег
 CZ Kasetka na peníze
 RO Casetá (cutie) pt. bani
 H Pénzes kassetta
 E Caja para efectivo

2x



No.	size / rozmiar (mm)	colour / kolor	
78632	180x115x55		24
78633	240x155x55		20

PL Klódka żelwna
 GB Iron padlock
 D Vorhängeschloss
 RUS Замок навесной



3x



No.	L (mm)	
77010	32	6/120
77020	38	6/120
77030	50	6/60
77040	63	6/36
77050	75	6/36

PL Klódka żelwna
 GB Iron padlock
 D Vorhängeschloss
 RUS Замок навесной



3x



No.	L (mm)	
77061	32	12/120
77062	38	12/120
77063	50	6/60
77064	63	6/36

PL Klódka żelwna
 GB Iron padlock
 D Vorhängeschloss
 RUS Замок навесной
 CZ Stavební visací zámek
 RO Lacát pt. construcii
 H Óriás lakat
 E Candado de hierro fundido



3x



No.	L (mm)	
77051	32	12/240
77052	38	6/240
77053	50	6/120
77054	63	6/60
77055	75	6/36

PL Klódka żelwna powlekana
 GB Alloy covered iron padlock
 D Vorhängeschloss
 RUS Замок навесной



4x



No.	L (mm)	
77004	40	12/96
77005	50	12/72
77006	60	12/48

- PL Klódka żelwna
- GB Iron padlock
- D Vorhängeschloss
- RUS Замок навесной
- CZ Stavební visací zámek
- RO Lacăt pt. construcții
- H Óriás lakat
- E Candado de hierro fundido



No.	L (mm)	
77110	40	6/120
77120	50	6/60
77130	60	6/36
77140	75	6/36
77150	85	6/36

- PL Klódka żelwna
- GB Alloy covered iron padlock
- D Vorhängeschloss
- RUS Замок навесной



VOREL

No.	L (mm)	
77230	40	6/72
77231	50	6/72
77232	60	6/48



- PL Klódka trzpieniowa
- GB Alloy covered padlock
- D Vorhängeschloss
- RUS Стержневой навесной замок чугунный
- CZ Stavební visací zámek
- RO Lacăt pt. construcții
- H Óriás lakat
- E Candado de mandril de hierro fundido cubierto



VOREL

No.	L (mm)	
77240	75	6/48
77241	90	6/24



- PL Klódka mosiężna
- GB Plated brass padlock
- D Messigvorhängeschloss
- RUS Замок навесной латунный
- CZ Zámek visací mosazný
- RO Lacăt alama
- H Lakat sárgaréz
- E Candado de latón



VOREL

No.	L (mm)	
77235	40	6/72



- PL Klódka mosiężna
- GB Plated brass padlock
- D Messigvorhängeschloss
- RUS Замок навесной латунный
- CZ Zámek visací mosazný
- RO Lacăt alama
- H Lakat sárgaréz
- E Candado de latón



VOREL

No.	L (mm)	
77249	63	6/36



- PL Klódka trzpieniowa
- GB Rectangular brass padlock
- D Messigvorhängeschloss
- RUS Стержневой навесной замок латунный
- CZ Visací zámek čerový
- RO Lacăt din alamă cu becluș drept
- H Réz hengerzárás u lakat
- E Candado de latón de mandril



VOREL

No.	L (mm)	
77210	50	6/120
77211	65	6/96
77212	75	6/60
77213	90	6/36



- PL Klódka mosiężna
- GB Plated brass padlock
- D Vorhängeschloss
- RUS Замок навесной латунный
- CZ Zámek visací mosazný
- RO Lacăt alama
- H Lakat sárgaréz
- E Candado de latón



No.	L (mm)	
77250	25	12/600
77300	30	12/480
77350	35	12/300
77400	40	12/240
77500	50	12/144
77600	60	12/144



- PL Klódka mosiężna
- GB Plated brass padlock
- D Vorhängeschloss
- RUS Замок навесной латунный
- CZ Zámek visací mosazný
- RO Lacăt alama
- H Lakat sárgaréz
- E Candado de latón



No.	L (mm)		
77603	25	4	12/120



PL Klódka szzyfrowa
GB Brass combination padlock
D Vorhängeschloss
RUS Замок навесной
CZ Zámek visací s číslným klíčem
RO Lacat alama cu cifru
H Lakat sárgaréz számkombinációs
E Candado de latón



No.



77607

12/120

PL Klódka mosiężna
GB Plated brass padlock
D Vorhängeschloss
RUS Замк

CZ Zámek visací mosazný
RO Lacet alama
H Lakat sárgaréz
E Candado de latón



No.

mm



77700

40x105

12/240

PL Wkładka do zamka
GB Lock cylinder
D Schliesszylinder
RUS Личинка замка латунная

CZ 900ND011 PHN
RO Yaľá pt. broască
H Zárbetét
E Inserción cromado

BRASS
MOSIADZ

No.	L (mm)	mm	key / klucz pcs	
77200	62	31/31	3	12/72
77203	72	31/41	3	12/72
77204	67	31/36	3	12/72
77205	87	36/51	3	12/72

PL Wkładka do zamka chromowana
GB Lock cylinder
D Schliesszylinder
RUS Личинка замка

CZ 900ND011 PHN
RO Yaľá pt. broască
H Zárbetét
E Inserción cromado

BRASS
MOSIADZ

No.	L (mm)	mm	key / klucz pcs	
77170	62	31/31	3	12/72
77171	67	31/36	3	12/72

PL Wkładka do zamka
GB Lock cylinder
D Schliesszylinder
RUS Личинка замка латунная

CZ 900ND011 PHN
RO Yaľá pt. broască
H Zárbetét
E Inserción cromado

BRASS
MOSIADZ

No.	L (mm)	mm	key / klucz pcs	
77190	62	31/31	6	12/72
77191	67	31/36	6	12/72
77192	72	31/41	6	12/72
77193	87	36/51	6	12/72

PL Wkładka do zamka chromowana
GB Lock cylinder
D Schliesszylinder
RUS Личинка замка

CZ 900ND011 PHN
RO Yaľá pt. broască
H Zárbetét
E Inserción cromado

BRASS
MOSIADZ

No.	L (mm)	mm	key / klucz pcs	
77180	62	31/31	6	12/72

PL Wkładka do zamka
 GB Lock cylinder
 D Schliesszylinder
 RUS Личинка замка латунная

CZ 902ND0J1 PHN
 RO Yață pt. broască
 H Zárbetét
 E Inserción cromado

6xT

BRASS
 MOSIADZ



No.	L (mm)	mm	key / klucz pcs	
77194	62	31/31	6	12/72
77195	67	31/36	6	12/72
77196	67	36/31	6	12/72
77197	72	31/41	6	12/72
77198	72	41/31	6	12/72

PL Wkładka do zamka chromowana
 GB Lock cylinder
 D Schliesszylinder
 RUS Личинка замка

CZ 902ND0J1 PHN
 RO Yață pt. broască
 H Zárbetét
 E Inserción cromado

6xT

BRASS
 MOSIADZ



No.	L (mm)	mm	key / klucz pcs	
77184	62	31/31	6	12/72
77185	67	31/36	6	12/72
77186	67	36/31	6	12/72
77187	72	31/41	6	12/72
77188	72	41/31	6	12/72

PL Zamek wpuszczany bębnekowy
 GB Mortise lock for keyed cylinder
 and universal strike plate
 D Zylinder-Einbauschloss
 RUS Замок врезной цилиндрический

CZ =I PHN] DQDEDF YQANRYE
 RO Broască cu cilindru
 H Cilindres bevesőzár
 E Cerradura empotrada de tambor

90/25mm

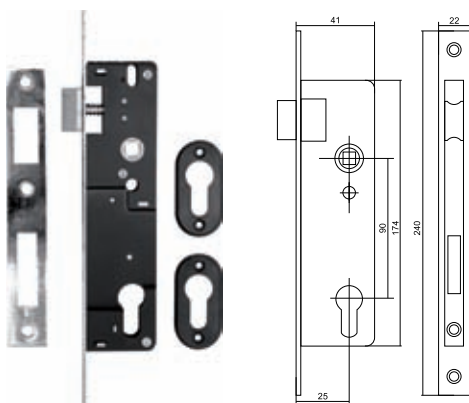

No.	mm	
78480	90/25	6/24

PL Zamek wpuszczany bębnekowy
 GB Mortise lock for keyed cylinder
 and universal strike plate
 D Zylinder-Einbauschloss
 RUS Замок врезной цилиндрический

CZ =I PHN] DQDEDF YQANRYE
 RO Broască cu cilindru
 H Cilindres bevesőzár
 E Cerradura empotrada de tambor

90/30 mm

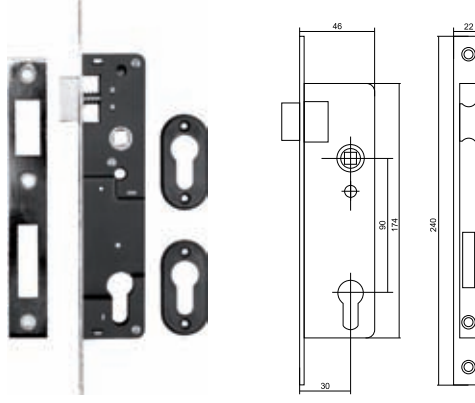

No.	mm	
78481	90/30	6/24

PL Zamek wpuszczany bębnekowy
 GB Mortise lock for keyed cylinder
 and universal strike plate
 D Zylinder-Einbauschloss
 RUS Замок врезной цилиндрический

CZ =I PHN] DQDEDF YQANRYE
 RO Broască cu cilindru
 H Cilindres bevesőzár
 E Cerradura empotrada de tambor

90/35 mm

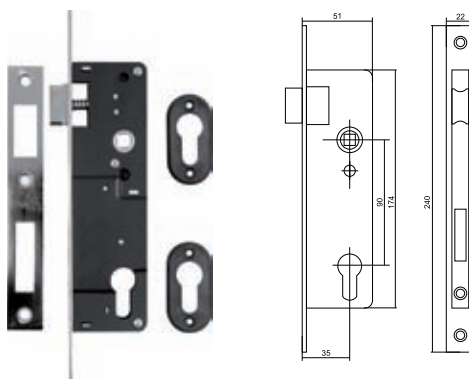

No.	mm	
78482	90/35	6/36

PL Zamek wpuszczany bębnowy
 GB Mortise lock for keyed cylinder
 and universal strike plate
 D Zylinder-Einbauschloss
 RUS Замок врезной цилиндрический

CZ =I P H N J D G D E D R Y D A N R Y E
 RO Broască cu cilindru
 H Cilindres bevesőzár
 E Cerradura empotrada de tambor

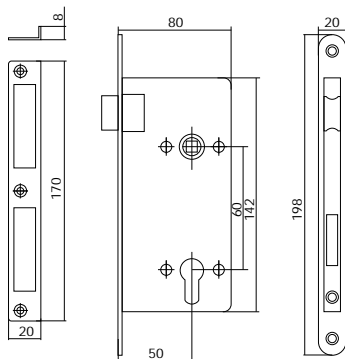

No.	mm	
78490	60/50	6/36

PL Zamek wpuszczany na klucz
 GB Mortise lock with lever mechanism
 and universal strike plate
 D Einbauschloss für Schlüssel
 RUS Замок врезной под ключ

CZ Zámek zadlabací na klič
 RO Broască uşă cu cheie
 H Bevesőzár, kulcsos
 E Cerradura empotrada de llave

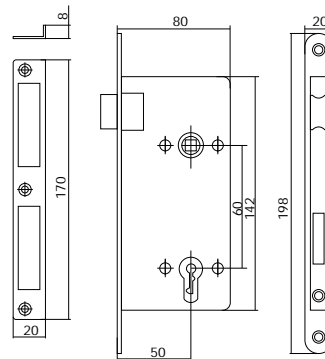

No.	mm	
78491	60/50	6/36

PL Zamek wpuszczany bębnowy
 GB Mortise lock for keyed cylinder
 and universal strike plate
 D Zylinder-Einbauschloss
 RUS Замок врезной цилиндрический

CZ =I P H N J D G D E D R Y D A N R Y E
 RO Broască cu cilindru
 H Cilindres bevesőzár
 E Cerradura empotrada de tambor

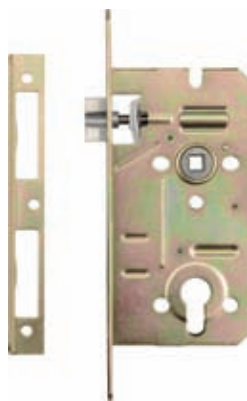
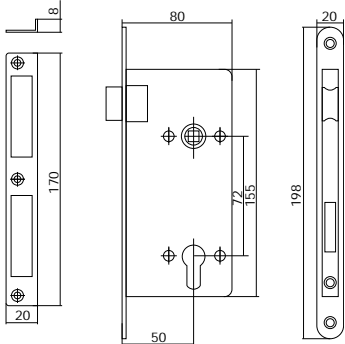

No.	mm	
78493	72/50	6/36

PL Zamek wpuszczany na klucz
 GB Mortise lock with lever mechanism
 and universal strike plate
 D Einbauschloss für Schlüssel
 RUS Замок врезной под ключ

CZ Zámek zadlabací na klič
 RO Broască uşă cu cheie
 H Bevesőzár, kulcsos
 E Cerradura empotrada de llave

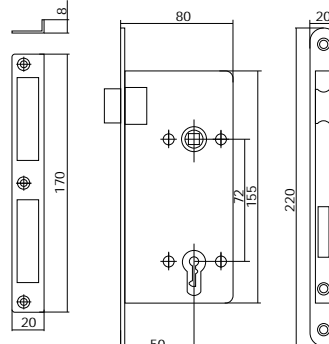

No.	mm	
78494	72/50	6/24

PL Zamek wpuszczany bębnowy
 GB Mortise lock for keyed cylinder
 and universal strike plate
 D Zylinder-Einbauschloss
 RUS Замок врезной цилиндрический

CZ =I P H N J D G O E D R Y B A N R Y E
 RO Broască cu cilindru
 H Cilindres bevesőzár
 E Cerradura empotrada de tambor

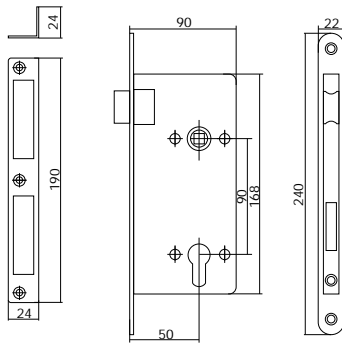

No.	mm	
78500	90/50	12/36

PL Zamek wpuszczany na klucz
 GB Mortise lock with lever mechanism
 and universal strike plate
 D Einbauschloss für Schlüssel
 RUS Замок врезной под ключ

CZ Zámek zadlabací na kľúč
 RO Broască uşă cu cheie
 H Bevesőzár, kulcsos
 E Cerradura empotrada de llave

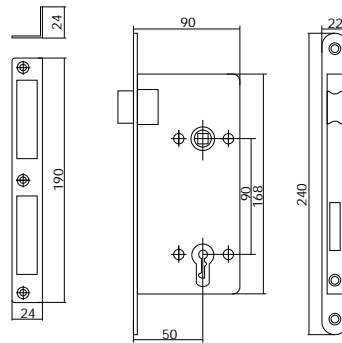

No.	mm	
78501	90/50	6/24

PL Zamek wpuszczany bębnowy
 GB Mortise lock for keyed cylinder
 and universal strike plate
 D Zylinder-Einbauschloss
 RUS Замок врезной цилиндрический

CZ =I P H N J D G O E D R Y B A N R Y E
 RO Broască cu cilindru
 H Cilindres bevesőzár
 E Cerradura empotrada de tambor

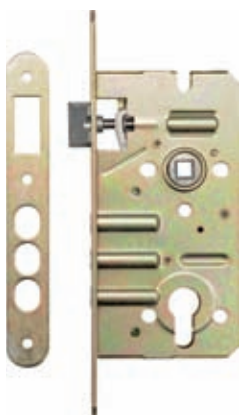
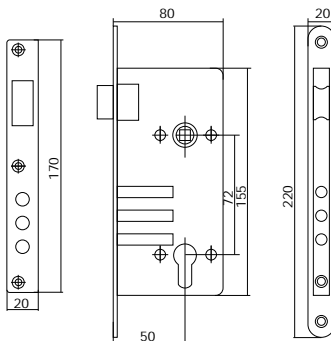

No.	mm	
78510	72/50	6/24

PL Zamek wpuszczany bębnowy
 GB Mortise lock for keyed cylinder
 and universal strike plate
 D Zylinder-Einbauschloss
 RUS Замок врезной цилиндрический

CZ =I P H N J D G O E D R Y B A N R Y E
 RO Broască cu cilindru
 H Cilindres bevesőzár
 E Cerradura empotrada de tambor

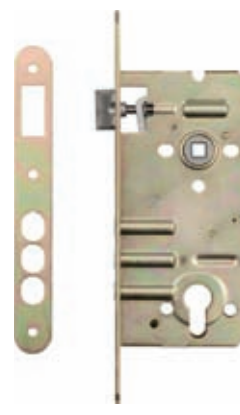
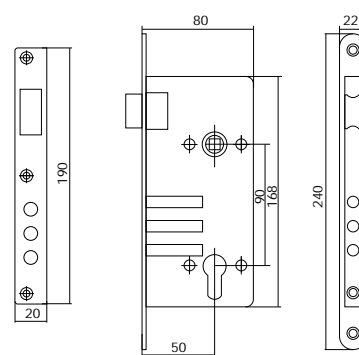
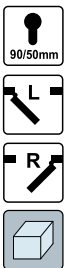

No.	mm	
78511	90/50	6/24

PL Zamek wpuszczany bębnowy
 GB Mortise lock for keyed cylinder and universal strike plate
 D Zylinder-Einbauschloss
 RUS Замок врезной цилиндрический

CZ =I P H N J D O D E D F A Y O B A N Y E
 RO Broască cu cilindru
 H Cilindres bevesőzár
 E Cerradura empotrada de tambor

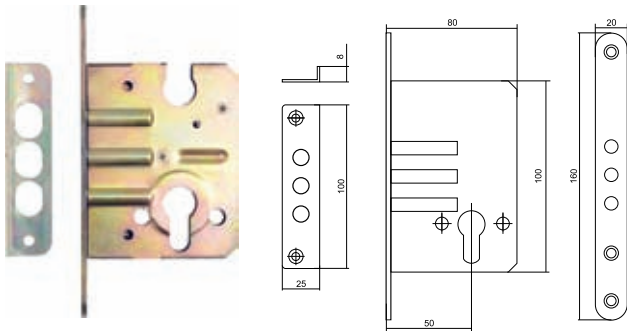

No.	mm	
78513	50	12/48

PL Zamek wpuszczany
 GB Mortise lock for keyed cylinder with latch and bolt
 D Einbauschloss
 RUS Замок врезной

CZ Zámek zadlabací
 RO Yalá uşá
 H Bevesőzár
 E Cerradura empotrada

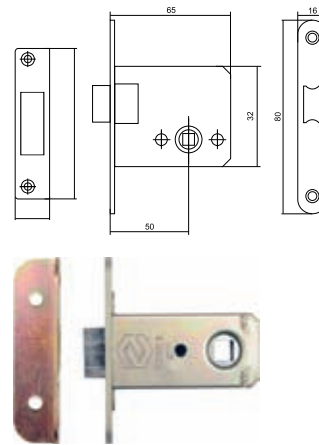

No.	mm	
78520	50	12/72

PL Zamek wpuszczany łazienkowy
 GB Mortise lock with one side knob and universal strike plate
 D Einbauschloss für Badezimmer
 RUS Замок врезной для ванной комнаты

CZ Zámek zadlabací pro koupelny
 RO Broască uşá baie
 H Bevesőzár, fürdőszobai
 E Cerradura empotrada para baños

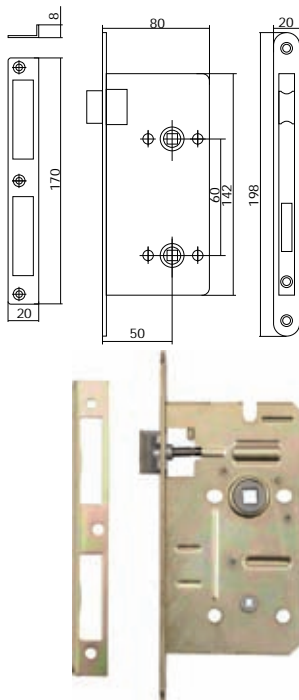

No.	mm	
78525	60/50	6/36

PL Zamek wpuszczany łazienkowy
 GB Mortise lock with one side knob and universal strike plate
 D Einbauschloss für Badezimmer
 RUS Замок врезной для ванной комнаты

CZ Zámek zadlabací pro koupelny
 RO Broască uşá baie
 H Bevesőzár, fürdőszobai
 E Cerradura empotrada para baños

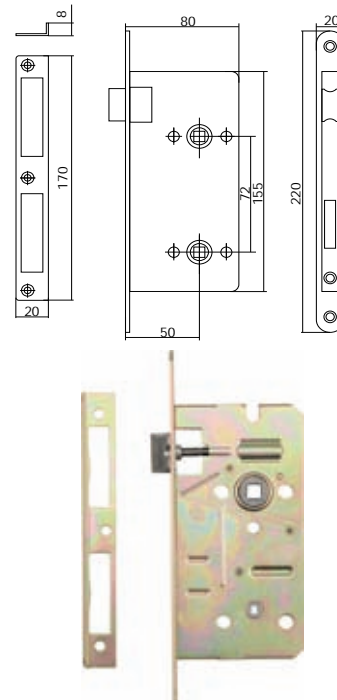

No.	mm	
78526	72/50	6/36

PL Zasuwka mosiądzowana
 GB Bolt
 D Türriegel, mit Messingüberzug
 RUS Задвижка латунированная

CZ Dveřní zastrž pomosazená
 RO Zăvor alamá
 H Sárgaréz tolózár
 E Cerrojo de latón



No.	slide legh / dtugosć trzpenia (mm)	body length / dtugosć obudowy (mm)	striker length / dtugosć obejmj (mm)	height / wysokosć (mm)	
76900	40	40	23	26	18/144
76901	50	51	23	26	12/144
76902	63	64	23	26	12/144
76903	75	76	26	29	12/144
76904	100	102	26	29	12/144
76905	121	127	29	35	12/120
76906	138	152	29	35	12/96

PL Zasuwka mosiądzowana
GB Bolt
D Türriegel, mit Messingüberzug
RUS Задвижка латунированная

CZ Dveřní zastrč pomosazená
RO Zăvor alamă
H Sărgarez tolózár
E Cerrojo de latón



No.	slide legh / długość trzpienia (mm)	body length / długość obudowy (mm)	striker length / długość obejmę (mm)	height / wysokość (mm)	
76910	50	35	16	40	12/288
76911	63	45	16	40	12/288
76912	75	55	16	40	12/240
76913	100	77	16	40	12/192
76914	125	98	16	40	12/144
76915	150	120	16	40	12/120

PL Zasuwka niklowana
GB Bolt
D Türriegel, vernickelt
RUS Задвижка никелированная

CZ Dveřní zastrč poniklovaná
RO Zăvor nichel
H Nikkelezett tolózár
E Cerrojo níquelado



No.	slide legh / długość trzpienia (mm)	body length / długość obudowy (mm)	striker length / długość obejmę (mm)	height / wysokość (mm)	
76920	40	25	11	35	12/360
76921	45	30	11	35	12/360
76922	53	35	11	35	12/360
76923	57	40	16	45	12/360
76924	68	50	16	52	12/288

PL Zasuwka niklowana
GB Bolt
D Türriegel, vernickelt
RUS Задвижка никелированная

CZ Dveřní zastrč poniklovaná
RO Zăvor nichel
H Nikkelezett tolózár
E Cerrojo níquelado



No.	slide legh / długość trzpienia (mm)	body length / długość obudowy (mm)	striker length / długość obejmę (mm)	height / wysokość (mm)	
76930	53	40	13	32	12/288
76931	64	50	13	31	12/288
76932	73	55	15	36	12/240
76933	95	77	15	36	12/192
76934	114	100	15	36	12/144
76935	144	118	16	43	12/120

PL Zasuwka ocynkowana
GB Bolt
D Türriegel, verzinkt
RUS Задвижка оцинкованная

CZ Dveřní zastrč pozinkovaná
RO Zăvor zincat
H Galvanizált tolózár
E Cerrojo galvanizado



No.	slide legh / długość trzpienia (mm)	body length / długość obudowy (mm)	striker length / długość obejmę (mm)	height / wysokość (mm)	
76940	105	70	27	70	10/80
76941	127	85	27	70	10/60
76942	148	100	27	70	10/60

PL Zasuwka ocynkowana
GB Bolt
D Türriegel, verzinkt
RUS Задвижка оцинкованная

CZ Dveřní zastrč pozinkovaná
RO Zăvor zincat
H Galvanizált tolózár
E Cerrojo galvanizado



No.	slide legh / długość trzpienia (mm)	body length / długość obudowy (mm)	striker length / długość obejmę (mm)	height / wysokość (mm)	
76943	105	93	38	70	10/40
76944	127	116	38	70	10/40
76945	180	152	38	70	10/30

PL Zasuwka stalowa czerniona
GB Bolt
D Stahltürriegel, geschwärzt
RUS Задвижка стальная вороненая

CZ Dveřní zastrč ocelová černěná
RO Zăvor de oțel brunat
H Barnított acél tolózár
E Cerrojo de acero pavonado



No.	slide legh / długość trzpienia (mm)	body length / długość obudowy (mm)	striker length / długość obejmę (mm)	height / wysokość (mm)	
76950	84	75	30	45	12/96
76951	133	117	30	45	12/96

PL Łańcuch do drzwi
GB Safety chain
D Türsicherungskette
RUS Замок-цепь для двери

CZ Řetěz na dveře
RO Lanț pt. ușă
H Ajtólánc
E Cadena para puerta



No.

77900



12/120

PL Łańcuch do drzwi mosiądzowany
GB Safety chain
D Türkette, mit Messingüberzug
RUS Цепочка дверная латунированная

CZ Řetěz na dveře pomosazený
RO Lanț pt. ușă alamă
H Sárgarézt ajtólánc
E Cadena para puertas latonada



VOREL

No.

77911

track length /
długość zasuwki
(mm)

88

chain plate length /
długość płytki
łańcucha (mm)

18

track height / wy-
sokość zasuwki
(mm)

41

chain plate height /
wysokość płytki
łańcucha (mm)

51



20/120

PL Łańcuch do drzwi
GB Safety chain
D Türsicherungskette
RUS Замок-цепь для двери

CZ Řetěz na dveře
RO Lanț pt. ușă
H Ajtólánc
E Cadena para puerta



No.

77910



12/120

PL Łańcuch do drzwi niklowany
GB Safety chain
D Türkette, vernickelt
RUS Цепочка дверная никелированная

CZ Řetěz na dveře poniklovány
RO Lanț pt. ușă nichie
H Nikkelezett ajtólánc
E Cadena para puertas niquelada



VOREL

No.

77912

track length /
długość zasuwki
(mm)

88

chain plate length /
długość płytki
łańcucha (mm)

18

track height / wy-
sokość zasuwki
(mm)

41

chain plate height /
wysokość płytki
łańcucha (mm)

51



20/120

PL Automacyjny zamykacz do drzwi
GB Door closer
D Automatischer Türschließer
RUS Доводчик дверной

CZ Automatický zavírač dveří
RO Înculetoare automată ușă
H Ajtófék
E Muelle de puerta

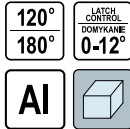

VOREL

No.

78460

kg

25-45



10

78463

45-65

10

PL Wizjer z klapką
GB Door peep hole with flap
D Türspion
RUS Глазок дверной с заслонкой

CZ Hledáček s klapkou
RO Vizor cu clapă
H Kitekintő, fedéllel
E Mirilla con tapa



No.

77920

mm

35-50

angle / kąt

200°



40/480

PL Wizjer z klapką
GB Door peep hole with flap
D Türspion
RUS Глазок дверной с заслонкой

CZ Hledáček s klapkou
RO Vizor cu clapă
H Kitekintő, fedéllel
E Mirilla con tapa



No.

77921

mm

35-50

angle / kąt

200°



40/480

PL Zawieszki plastikowe do kluczy
GB Key indicators
D Schlüsselanhänger
RUS Брелок для ключей

CZ Přívěšek na klíče
RO Breloc
H Kulcstartó
E Llaveros de plástico



No.

77930

pcs
packing

12



12/120

PL Linka rowerowa
GB Bicycle lock
D Fahrradschloss
RUS Замок велосипедный

CZ Zámek jízdního kola
RO Antifurt pt. bicicleta
H Kerékpárzár
E Cable antirrobo para bicicletas

65 cm 8 Ømm



No.	L (cm)	Ø (mm)	colour / kolor	☐
77830	65	8	●●●	12/120

PL Linka rowerowa
GB Bicycle lock
D Fahrradschloss
RUS Замок велосипедный

CZ Zámek jízdního kola
RO Antifurt pt. bicicleta
H Kerékpárzár
E Cable antirrobo para bicicletas

65 cm 8 Ømm



No.	L (cm)	Ø (mm)	colour / kolor	☐
77831	65	8	●●●	12/120

PL Linka rowerowa
GB Bicycle lock
D Fahrradschloss
RUS Замок велосипедный

CZ Zámek jízdního kola
RO Antifurt pt. bicicleta
H Kerékpárzár
E Cable antirrobo para bicicletas



No.	L (cm)	Ø (mm)	colour / kolor	☐
77833	120	8	●●●	10/60
77834	120	10	●●●	10/60
77835	180	10	●●●	10/60

PL Linka rowerowa
GB Bicycle lock
D Fahrradschloss
RUS Замок велосипедный

CZ Zámek jízdního kola
RO Antifurt pt. bicicleta
H Kerékpárzár
E Cable antirrobo para bicicletas



No.	L (cm)	Ø (mm)	colour / kolor	☐
77837	120	8	●●●	10/60
77838	150	10	●●●	10/60

PL Linka rowerowa
GB Bicycle lock
D Fahrradschloss
RUS Замок велосипедный

CZ Zámek jízdního kola
RO Antifurt pt. bicicleta
H Kerékpárzár
E Cable antirrobo para bicicletas

120 cm 10 Ømm



No.	L (cm)	Ø (mm)	colour / kolor	☐
77845	120	10	●●●	20/40

PL Linka rowerowa
GB Bicycle lock
D Fahrradschloss
RUS Замок велосипедный

CZ Zámek jízdního kola
RO Antifurt pt. bicicleta
H Kerékpárzár
E Cable antirrobo para bicicletas

180 cm 12 Ømm



No.	L (cm)	Ø (mm)	colour / kolor	☐
77840	180	12	●●●	10/40

PL Linka stalowa z kłódką
GB Security cable and lock
D Stahlsel, mit Vorhängeschloss
RUS Канат стальной с замком

CZ Ocelové lanko s visacím zámkem
RO Sârmă de oțel cu lacăt
H Drótkötél, lakattal
E Cuerda de acero con candado

3m 3x 4mm BRASS MOSIADZ



No.	L (m)	Ø (mm)	☐
77815	3	4	12/48

PL Zapięcie rowerowe
GB Bicycle lock
D Fahrradschloss
RUS Замок велосипедный

CZ Zámek jízdního kola
RO Antifurt pt. bicicleta
H Kerékpárzár
E Cable antirrobo para bicicletas

100 cm 18 Ømm 2x



No.	L (cm)	Ø (mm)	☐
77850	100	18	12/24

PL Zapięcie rowerowe
 GB Bicycle lock
 D Fahrradschloss
 RUS Замок велосипедный

CZ Zámek jízdního kola
 RO Antifurt pt. bicicleta
 H Kerékpárzár
 E Cable antirrobo para bicicletas



120 cm
 18 Ømm
 2x



No.	L (cm)	Ø (mm)	
77851	120	18	12/24

PL Zapięcie rowerowe
 GB Bicycle lock
 D Fahrradschloss
 RUS Замок велосипедный

CZ Zámek jízdního kola
 RO Antifurt pt. bicicleta
 H Kerékpárzár
 E Cable antirrobo para bicicletas



120 cm
 20 Ømm
 2x



No.	L (cm)	Ø (mm)	
77852	120	20	12/24

PL Zapięcie motocyklowe
 GB Motorcycle lock
 D Stahlgliederschloss
 RUS Замок до мотоцикла

CZ Zámek na kolo
 RO Anti-furt motocicletă
 H Láncaklat motorbiciklikhez
 E Candado para Moto



100 cm
 22 Ømm
 2x



No.	L (cm)	Ø (mm)	
77860	100	22	12

PL Zapięcie motocyklowe
 GB Motorcycle lock
 D Stahlgliederschloss
 RUS Замок до мотоцикла

CZ Zámek na kolo
 RO Anti-furt motocicletă
 H Láncaklat motorbiciklikhez
 E Candado para Moto



150 cm
 25 Ømm
 2x



No.	L (cm)	Ø (mm)	
77861	150	25	6/12

PL Zapięcie łańcuchowe z zamkiem
 GB Chain lock
 D Kettenschloss mit Schloss
 RUS Цепь с замком

CZ Bezpečnostní řetěz se zámkem
 RO Încuetoare lanț cu lacăt
 H Kerékpár lakat
 E Candado de cadena con cerradura



120 cm
 7 Ømm
 2x



No.	L (cm)	Ø (mm)	
77881	120	7	12

PL Zapięcie typu U-lock
 GB U-type lock
 D Bügelschloss
 RUS Замок до мотоцикла

CZ Zámek na kolo „U” typ
 RO Anti-furt tip „U”
 H U-lakat motorbiciklikhez
 E Candado tipo „U”



21 cm
 13 Ømm
 2x



No.	L (cm)	Ø (mm)	
77870	21	13	10/20

PL Zapięcie typu U-lock
 GB U-type lock
 D Bügelschloss
 RUS Замок до мотоцикла

CZ Zámek na kolo „U” typ
 RO Anti-furt tip „U”
 H U-lakat motorbiciklikhez
 E Candado tipo „U”



24.5 cm
 14 mm
 2x



No.	L (cm)	Ø (mm)	
77871	24.5	14	6/12

PL Zapięcie typu U-lock
 GB U-type lock
 D Bügelschloss
 RUS Замок до мотоцикла

CZ Zámek na kolo „U” typ
 RO Anti-furt tip „U”
 H U-lakat motorbiciklikhez
 E Candado tipo „U”



30 cm
 15 Ømm
 2x



No.	L (cm)	Ø (mm)	
77872	30	15	5/10

18

Tool bags & boxes
Torby i skrzynki narzędziowe

Tool bags & boxes
Torby i skrzynki narzędziowe



242-244

Tool bags

Torby narzędziowe..... 242

Leather tool belts

Skórzane pasy narzędziowe..... 242

Plastic tool boxes

Plastikowe skrzynki narzędziowe..... 242

Metal tool boxes

Metalowe skrzynki narzędziowe..... 244

PL Torba narzędziowa
GB Tool bag
D Werkzeugkoffer
RUS Сумка для инструмента

CZ Nástrojová taška
RO Geantă pt. scule
H Szeszámosztáska
E Maletin de herramientas



No.	cm	
78700	40x25x12	4
78710	46x30x15	2

PL Torba narzędziowa
GB Tool bag
D Werkzeugkoffer
RUS Сумка для инструмента

CZ Nástrojová taška
RO Geantă pt. scule
H Szeszámosztáska
E Maletin de herramientas



No.	cm	
78720	43x27x17	2

PL Torba narzędziowa
GB Tool bag
D Werkzeugkoffer
RUS Сумка для инструмента

CZ Nástrojová taška
RO Geantă pt. scule
H Szeszámosztáska
E Maletin de herramientas



No.	cm	
78730	41x25x15	2

PL Pas monterski
GB Tool belt
D Leder-gürteltasche
RUS Пояс монтажника кожаный

CZ Montéřná SI VlnáHC
RO Centura port scule - plele
H Bőr szerszámosív
E Cinturon de montaje de piel



No.	
78750	50

PL Skrzynka narzędziowa
GB Tool box
D Plastikwerkzeugkoffer
RUS Ящик для инструмента-пластмассовый

CZ Nástrojová skřínka plastikov
RO Cutie din plastic pt. scule
H Szeszámoszláda, műanyag
E Caja de herramientas de plastico



No.	size / rozmiar	
78801	12" (30 cm)	6
78800	16" (40 cm)	5

PL Skrzynka narzędziowa
GB Tool box
D Plastikwerkzeugkoffer
RUS Ящик для инструмента-пластмассовый

CZ Nástrojová skřínka plastikov
RO Cutie din plastic pt. scule
H Szeszámoszláda, műanyag
E Caja de herramientas de plastico



No.	size / rozmiar	
78802	20" (50 cm)	2

PL Skrzynka narzędziowa
GB Tool box
D Plastikwerkzeugkoffer
RUS Ящик для инструмента-пластмассовый

CZ Nástrojová skřínka plastikov
RO Cutie din plastic pt. scule
H Szeszámoszláda, műanyag
E Caja de herramientas de plastico



No.	size / rozmiar	
78803	22" (55 cm)	2

PL Skrzynka narzędziowa
GB Tool box
D Plastikwerkzeugkoffer
RUS Ящик для инструмента-пластмассовый

CZ Nástrojová skřínka plastikov
RO Cutie din plastic pt. scule
H Szeszámoszláda, műanyag
E Caja de herramientas de plastico



No.	size / rozmiar	mm	
78809	15"	385x160x170	15
78810	19"	480x240x225	20

- PL Skrzynka narzędziowa
GB Tool box
D Plastikwerkzeugkoffer
RUS Ящик для инструмента-пластмассовый
- CZ Nástrojová skříňka plastíková
RO Cutie din plastic pt. scule
H Szerszámoszláda, műanyag
E Caja de herramientas de plástico



VOREL

No.	size / rozmiar	
78811	12" (30 cm)	1
78812	16" (40 cm)	1
78813	20" (50 cm)	1
78815	26" (65 cm)	1

- PL Szufladki warsztatowe
GB Workshop drawers
D Werkstattschubfächer
RUS Ящики для инструментов
CZ Skříňka se zásobníky
RO Sertare atelier
H Műhely zsámoly fiókkal
E Cajones para taller



VOREL

No.	mm	compartments / szufladki	
78785	225x155x100	10	20

- PL Organizer
GB Organizer
D Werkzeugkaste
RUS Органайзер
- CZ Organizér
RO Cutie tip organizator
H Mű. csavartartó doboz
E Caja



VOREL

No.	mm	compartments / przegródki	
78790	200x145x35	7	10

- PL Organizer Domino
GB Organizer
D Werkzeugkaste
RUS Органайзер
CZ Organizér
RO Cutie tip organizator
H Mű. csavartartó doboz
E Caja



VOREL

No.	mm	compartments / przegródki	
78793	120x100x30	8	38

- PL Organizer Domino
GB Organizer
D Werkzeugkaste
RUS Органайзер
- CZ Organizér
RO Cutie tip organizator
H Mű. csavartartó doboz
E Caja



VOREL

No.	mm	compartments / przegródki	
78791	300x220x55	10	10

- PL Organizer
GB Organizer
D Werkzeugkaste
RUS Органайзер
CZ Organizér
RO Cutie tip organizator
H Mű. csavartartó doboz
E Caja



No.	cm	
78816	31x21x5.5	10
78818	35x25x5.5	10

- PL Organizer
GB Organizer
D Werkzeugkaste
RUS Органайзер
CZ Organizér
RO Cutie tip organizator
H Mű. csavartartó doboz
E Caja



No.	cm	
78794	36x27	5

- PL Organizer
GB Organizer
D Werkzeugkaste
RUS Органайзер
- CZ Organizér
RO Cutie tip organizator
H Mű. csavartartó doboz
E Caja



No.	cm	
78819	46x32	5

PL Pojemnik magazynowy
 GB Storage case
 D Lagersichtbox
 RUS Ящик для склада

CZ Box skladovací
 RO Cutie scule diverse
 H Tárolók
 E Contenedeor de almacen



No.	type	cm	
78822	P-2	16x11.5x7.5	40
78824	P-4	23.5x17.3x12.5	20
78825	P-5	34x20x15	9
78826	P-6	44x31.5x18	6

PL Skrzynka narzędziowa
 GB Cantilever tool box
 D Werkzeugkoffer
 RUS Ящик для инструмента

CZ Nástrojová skříňka
 RO Cutie metalica pt. scule
 H Szerszámosláda
 E Caja de herramientas



No.	cm	compartments / szuflady	
81840	40x21x15	3	1

PL Skrzynka narzędziowa
 GB Cantilever tool box
 D Werkzeugkoffer
 RUS Ящик для инструмента

CZ Nástrojová skříňka
 RO Cutie metalica pt. scule
 H Szerszámosláda
 E Caja de herramientas



No.	cm	compartments / szuflady	
81843	40x21x19	5	1

PL Skrzynka narzędziowa
 GB Cantilever tool box
 D Werkzeugkoffer
 RUS Ящик для инструмента

CZ Nástrojová skříňka
 RO Cutie metalica pt. scule
 H Szerszámosláda
 E Caja de herramientas



No.	cm	compartments / szuflady	
81844	50x20x29	5	1

Memo

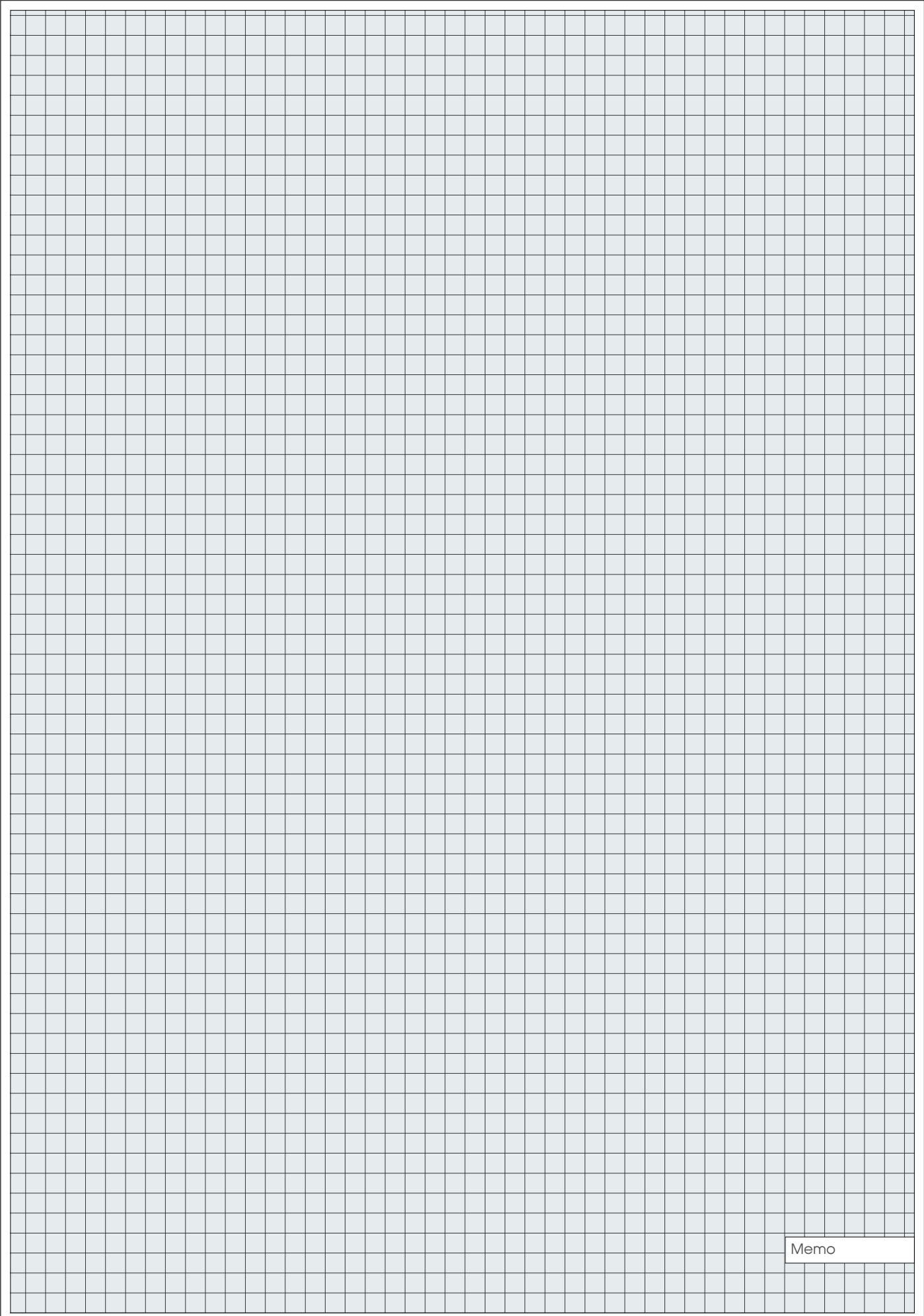

Memo

19

Household equipment Gospodarstwo domowe

Mailboxes
Skrzynki na listy

..... 248-249 

Coal stoves & accessories
Piecyki węglowe i akcesoria

..... 249-251 

Brushes
Szczotki

..... 252-253 

Mops
Zgarniacze do wody

..... 253 

Snow shovels
Łopaty do śniegu

..... 253 

Bags
Worki

..... 253-255 

Tarpaulins
Plandeki

..... 255 

Ash filters & accessories
Urządzenia do filtrowania popiołu, odkurzacze do popiołu i akcesoria

..... 256 

Syphon pumps
Pompy syfonowe

..... 256 

Pumps
Pompki

..... 257 

Hydraulic accessories
Akcesoria hydrauliczne

..... 257 

Vaselines
Wazeliny techniczne

..... 257 

Casters
Kółka

..... 258-259 

Seals
Uszczelnienia

..... 260 

Self-adhesive furniture pads
Podkładki samoprzylepne pod meble

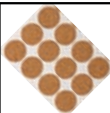
..... 260-264 

Plastic stools
Stołki plastikowe

..... 264 

Hooks & furniture protection
Haczyki i zabezpieczenia

..... 264-267 

Hooks
Wieszaki

..... 267-269 

Cable organizers
Organizery do kabli

..... 269 

PL Skrzynka na listy
GB Mailbox
D Briefkasten
RUS Почтовый ящик
CZ Schránka na dopisy
RO Cutie poştală
H Levélláda
E Buzón



300x210x65 mm



No.	size / rozmiar (mm)	colour / kolor	
78550	300x210x65	●	12
78551	300x210x65	●	12
78552	300x210x65	●	12
78553	300x210x65	●	12

PL Skrzynka na listy
GB Mailbox
D Briefkasten
RUS Почтовый ящик
CZ Schránka na dopisy
RO Cutie poştală
H Levélláda
E Buzón



360x260x80 mm



No.	size / rozmiar (mm)	colour / kolor	
78555	360x260x80	●	6
78556	360x260x80	●	6
78557	360x260x80	●	6

PL Skrzynka na listy
GB Mailbox
D Briefkasten
RUS Почтовый ящик
CZ Schránka na dopisy
RO Cutie poştală
H Levélláda
E Buzón



360x230x90 mm



No.	size / rozmiar (mm)	colour / kolor	
78560	360x230x90	●	10
78561	360x230x90	●	10
78562	360x230x90	●	10

PL Skrzynka na listy
GB Mailbox
D Briefkasten
RUS Почтовый ящик
CZ Schránka na dopisy
RO Cutie poştală
H Levélláda
E Buzón



380x210x60 mm



No.	size / rozmiar (mm)	colour / kolor	
78566	380x210x60	●	8
78568	380x210x60	●	8

PL Skrzynka na listy
GB Mailbox
D Briefkasten
RUS Почтовый ящик
CZ Schránka na dopisy
RO Cutie poştală
H Levélláda
E Buzón



400x250x100 mm



No.	size / rozmiar (mm)	colour / kolor	
78570	400x250x100	●	6
78571	400x250x100	●	6
78572	400x250x100	●	6

PL Skrzynka na listy
GB Mailbox
D Briefkasten
RUS Почтовый ящик
CZ Schránka na dopisy
RO Cutie poştală
H Levélláda
E Buzón







310x360x100 mm



No.	size / rozmiar (mm)	colour / kolor	
78575	310x360x100	●	6
78576	310x360x100	●	6
78577	310x360x100	●	6





PL Skrzynka na listy
GB Mailbox
D Briefkasten
RUS Почтовый ящик
CZ Schránka na dopisy
RO Cutie poştală
H Levélláda
E Buzón

380x320x105
mm2x 

No.	size / rozmiar (mm)	colour / kolor	
78580	380x320x105		5
78581	380x320x105		5
78582	380x320x105		5

PL Skrzynka na listy
GB Mailbox
D Briefkasten
RUS Почтовый ящик
CZ Schránka na dopisy
RO Cutie poştală
H Levélláda
E Buzón





380x320x105
mm2x 

No.	size / rozmiar (mm)	colour / kolor	
78585	380x320x105		5
78586	380x320x105		5
78587	380x320x105		5

PL Skrzynka na listy
GB Mailbox
D Briefkasten
RUS Почтовый ящик

CZ Schránka na dopisy
RO Cutie poştală
H Levélláda
E Buzón

480x280x80
mm2x 

No.	size / rozmiar (mm)	colour / kolor	
78590	480x280x80		5
78591	480x280x80		5
78592	480x280x80		5

PL Piecyk węglowy
GB Coal stove
D Kohleofen
RUS Угольная печь
CZ Kamna na uhlí
RO Soba
H Szenes kályha
E Calentador de carbón



No.	
72988	8

PL Piecyk węglowy
GB Coal stove
D Kohleofen
RUS Угольная печь
CZ Kamna na uhlí
RO Soba
H Szenes kályha
E Calentador de carbón



No.	
72989	8

PL Piecyk węglowy
GB Coal stove
D Kohleofen
RUS Угольная печь
CZ Kamna na uhlí
RO Soba
H Szenes kályha
E Calentador de carbón



No.	
72990	8

PL Blacha przyplecowa ocynkowana
 GB Galvanized stove metal plate
 D Brennblech, verzinkt
 RUS Оцинкованный лист для обшивки печи
 CZ 3R3BAND SRGSHF] SR] IQRDQKR SDFKX
 RO Tablă sobă zincată
 H Galvanizált hő terező lemez kályhához
 E Chapa galvanizada para estufa



No.	size / rozmiar (mm)	thickness / grubość (mm)	
72933	305x475	0.5	10
72934	396x600	0.5	10
72935	485x663	0.5	10

PL Blacha przyplecowa malowana
 GB Painted stove metal plate
 D Brennblech, mit Farbanstrich
 RUS Оцинкованный окрашенный лист для обшивки печи
 CZ 3R3BAND SRGSHF] QRNDQKR SDFKX
 RO Tablă sobă vopsită
 H Festett hő terező lemez kályhához
 E Chapa pintada para estufa



No.	size / rozmiar (mm)	thickness / grubość (mm)	
72936	476x603	0.5	10
72937	476x800	0.5	10

PL Wycior kominowy
 GB Chimney cleaner
 D Schornsteinreiniger
 RUS Щетка для трубочистов
 CZ Kartáč kominový
 RO Racletă pt. coșul de fum
 H Kéménytisztító kefe
 E Arilla para baquetas de calefacción central



No.	Ø (mm)	L (mm)	
72948	120	180	15
72950	150	180	20
72951	175	180	18
72952	200	180	18

PL Kula kominarska
 GB Chimneysweep ball
 D Schornsteinfegerkugel
 RUS Гиря для трубочистов
 CZ Kaminkrčičo kamuolys
 RO Bilă pt. coșul de fum
 H Kémény golyó
 E Esfera del dehornador



No.		
72938	K15	4
72939	K25	4

PL Pręt do wyciorów
 GB Central heating cleaning rod
 D Stab für die Reiniger der Zentralheizung
 RUS Черенок для щеток – центральное отопление
 CZ Tyč k čistění
 RO Tije pt. racleji încalzire centrală
 H CO pálca a füstcsőtisztító keféhez
 E Baqueta para limpiar el sistema de calefacción central



No.	Ø (mm)	L (mm)	
72956	7	600	50
72958	7	800	50
72960	7	1000	50

PL Drut kominowy
 GB Chimney wire
 D Schornsteindraht
 RUS Проволока для трубочистов
 CZ Kaminkrčičo trosas
 RO Sarmă pt. coșul de fum
 H Kéménytisztító drót
 E Alambre de chimeneas



No.	Ø (mm)	L (m)	
72942	3.5	6	25
72943	3.5	8	20
72944	3.5	10	20
72945	3.5	12	20

PL Wycior do C.O.
 GB Chimney cleaner
 D Schornsteinreiniger
 RUS Щетка для трубочистов
 CZ Kartáč kominový
 RO Racletă pt. coșul de fum
 H Kéménytisztító kefe
 E Arilla para baquetas de calefacción central



No.	Ø (mm)	L (mm)	
72963	30	170	50
72964	40	170	50
72965	50	170	50
72966	60	170	35
72967	70	170	35
72968	80	170	30
72969	90	170	20
72970	100	170	20



PL Szufelka angielska
GB Shovel
D Schaufel
RUS Совок

CZ Lopatka
RO Lopățiță
H Lapát
E Pala



No.	mm	
72974	340x200	18

PL Pogrzebacz
GB Poker
D Schüreisen
RUS Кочепра

CZ Pohrabáč
RO Vătral
H Piszkavas
E Hurgón



No.	L (mm)	
72981	620	50

PL Szufelka gospodarcza
GB Shovel
D Schaufel
RUS Совок

CZ Lopatka
RO Lopățiță
H Lapát
E Pala



VOREL

No.	mm	
72976	380x220	20

PL Szufelka
GB Shovel
D Schaufel
RUS Совок

CZ Lopatka
RO Lopățiță
H Lapát
E Pala



No.	mm	
72977	550x180	30
72978	490x140	40

PL Szufelka szeroka
GB Shovel
D Schaufel
RUS Совок

CZ Lopatka
RO Lopățiță
H Lapát
E Pala



No.	mm	
72975	460x220	40

PL Szufelka mala
GB Shovel
D Schaufel
RUS Совок

CZ Lopatka
RO Lopățiță
H Lapát
E Pala



No.	mm	
72979	500x110	30

PL Węglarka duża
GB Coal carrier
D Kohlenkasten
RUS Ведро для угля

CZ Uhlák
RO Rezervor de cărbuni pt. sobă
H Szeneskosár
E Carbonera



No.	L (mm)	W (mm)	H (mm)	
72984	420	230	215	5

PL Węglarka mala
GB Coal carrier
D Kohlenkasten
RUS Ведро для угля

CZ Uhlák
RO Rezervor de cărbuni pt. sobă
H Szeneskosár
E Carbonera



No.	L (mm)	W (mm)	H (mm)	
72985	340	200	180	5

PL Miotta
GB Broom
D Strassenbesen
RUS Merna

CZ Metla
RO Matura
H Partvis
E Cepillo pelo largo



No.	mm	
35867	300x65	10
35868	400x65	10

PL Miotta
GB Broom
D Strassenbesen
RUS Merna

CZ Metla
RO Matura
H Partvis
E Cepillo pelo largo



No.		
35869		10

PL Miotta
GB Broom
D Strassenbesen
RUS Merna

CZ Metla
RO Matura
H Partvis
E Cepillo pelo largo



No.	L (mm)	
35870	300	10
35872	400	10
35874	500	10
35875	600	10
35876	800	10
35877	1000	10

PL Miotta
GB Broom
D Strassenbesen
RUS Merna

CZ Metla
RO Matura
H Partvis
E Cepillo pelo largo



No.	L (mm)	
35914	400x55	10
35915	500x55	10
35916	600x55	10
35918	800x55	10

PL Miotta drucziana do bruku
GB Broom
D Strassenbesen
RUS Merna

CZ Metla
RO Matura
H Partvis
E Cepillo pelo largo



No.	L (mm)	
35923	300x55	6
35924	400x55	6

PL Miotta
GB Broom
D Strassenbesen
RUS Merna

CZ Metla
RO Matura
H Partvis
E Cepillo pelo largo



No.	L (mm)	
35911	1150x22	140

PL Miotta
GB Broom
D Strassenbesen
RUS Merna

CZ Metla
RO Matura
H Partvis
E Cepillo pelo largo



No.	L (mm)	
35912	1200x22	15

PL Miotta
GB Broom
D Strassenbesen
RUS Merna

CZ Metla
RO Matura
H Partvis
E Cepillo pelo largo



No.	L (mm)	
35893	300	12
35894	400	12
35895	500	12

PL Miotła
GB Broom
D Strassenbesen
RUS Метла

CZ Metla
RO Matura
H Partvis
E Cepillo pelo largo



No.	L (mm)	
35899	250	12

PL Zgarniacz do wody
GB Mop
D Wasserschieber
RUS Сгон для уборки воды

CZ Štěrka s gumou
RO Mop cauciu
H Vízelhúzó gumi
E Recogedor de agua universal



VOREL

No.	L (mm)	
04561	330	120
04562	430	12/96

PL Łopata do śniegu
GB Plastic shovel for snow
D Kunststoff-schneeschaufel
RUS Лопата снеговая

CZ Lopata na sněh
RO Lopată pt. zăpadă
H Műanyag hólapát
E Pala para nieve



No.		
35880		180

PL Łopata do śniegu
GB Plastic shovel for snow
D Kunststoff-schneeschaufel
RUS Лопата снеговая

CZ Lopata na sněh
RO Lopată pt. zăpadă
H Műanyag hólapát
E Pala para nieve



VOREL

No.	mm	
35881	330x390	270

PL Łopata do śniegu
GB Plastic shovel for snow
D Kunststoff-schneeschaufel
RUS Лопата снеговая

CZ Lopata na sněh
RO Lopată pt. zăpadă
H Műanyag hólapát
E Pala para nieve



VOREL

No.	mm	
35889	400x430	180

PL Skuwacz do lodu
GB Ice breaker
D Eishammer
RUS Прибор для скрывывания льда

CZ Skováč na led
RO Spărgător pt. gheață
H Jég törő
E Rompehielo mango



VOREL

No.		
35878		125

PL Worki na gruz, mocne
GB Debris bags
D Müllsäcke stabil
RUS Мешки для щебня

CZ Pytle na suť
RO Saci pt. demolari
H Sittes zsák
E Bolsas para escombros



VOREL

No.	l	pcs packing	µm	
09475	80	10	142	10
09476	80	3	142	10
09477	120	10	142	10
09478	120	3	142	10

PL Worki na odpady, mocne
GB Waste bags
D Müllbeutel
RUS Пакеты для мусора

CZ Pytle na odpad
RO Saci gunoi
H Szemeteszsák
E Bolsas para desperdicios



VOREL

No.	l	pcs packing	µm	
09465	120	10	30	25
09466	160	10	40	15
09467	240	10	40	10

PL Worki na odpady, budowlane
GB Construction waste bags
D Müllsäcke
RUS Мешки для строительного мусора

CZ Pytle na stavební odpad
RO Saci gunoi pt. santier
H Zsák építési törmelékhez
E Bolsas para desperdicios de construcción



VOREL

No.	l	pcs. packing	µm	
09470	80	10	40	30
09471	120	15	60	10

PL Worki ogrodowe
GB Garden bags
D Gartensäcke
RUS Мешки для огорода

CZ Zahradní pytle
RO Saci gunoi pt. gradina
H Kerti szeméteszsák
E Bolsas de jardín



FLO

No.	l	pcs. packing	µm	
09481	120	10	60	15

PL Worki ogrodowe z taśmą
GB Garden bags with cord
D Gartensäcke mit Band
RUS Мешки для огорода с лентой

CZ Zahradní pytle zatahovací
RO Saci gunoi pt. gradina cu strangere
H Szalagos kerti szeméteszsák
E Bolsas de jardín con cinta

TÁŠMA
SCIAGAJĄCA
SHRINKING
BAND



FLO

No.	l	pcs. packing	µm	
09480	60	10	60	12
09482	120	10	60	15

PL Worki na odpady domowe
GB Waste bags
D Müllbeutel
RUS Пакеты для мусора

CZ Pytle na odpad
RO Saci gunoi
H Szeméteszsák
E Bolsas para desperdicios



VOREL

No.	l	pcs. packing	µm	
09486	35	50	6	40
09487	35	30	11	45
09489	60	20	13	45

PL Worki na odpady domowe z taśmą
GB Waste bags with cord
D Müllbeutel mit Band
RUS Пакеты для мусора с лентой

CZ Pytle na odpad
RO Saci gunoi
H Szeméteszsák
E Bolsas para desperdicios

TÁŠMA
SCIAGAJĄCA
SHRINKING
BAND



VOREL

No.	l	pcs. packing	µm	
09490	60	10	30	25

PL Worki na odpady z nadrukiem
GB Waste bags
D Müllbeutel
RUS Пакеты для мусора

CZ Pytle na odpad
RO Saci gunoi
H Szeméteszsák
E Bolsas para desperdicios

PLASTIC
PLASTIK



VOREL

No.	l	pcs / packing	µm	
10000	60	15	30	30
10010	120	10	40	25

PL Worki na odpady z nadrukiem
GB Waste bags
D Müllbeutel
RUS Пакеты для мусора

CZ Pytle na odpad
RO Saci gunoi
H Szeméteszsák
E Bolsas para desperdicios

PAPER
PAPIER



VOREL

No.	l	pcs / packing	µm	
10001	60	15	30	30
10011	120	10	40	25

PL Worki na odpady z nadrukiem
GB Waste bags
D Müllbeutel
RUS Пакеты для мусора

CZ Pytle na odpad
RO Saci gunoi
H Szeméteszsák
E Bolsas para desperdicios

GLASS
SZKŁO



VOREL

No.	l	pcs / packing	µm	
10002	60	15	30	30
10012	120	10	40	25

PL Worki na odpady z nadrukiem
 GB Waste bags
 D Müllbeutel
 RUS Пакеты для мусора

CZ Pytle na odpad
 RO Saci gunoi
 H Szemeteszsák
 E Bolsas para desperdicios

BIO



VOREL

No.	l	pcs / packing	µm	
10003	60	15	30	30
10013	120	10	40	25

PL Worki na odpady z nadrukiem
 GB Waste bags
 D Müllbeutel
 RUS Пакеты для мусора

CZ Pytle na odpad
 RO Saci gunoi
 H Szemeteszsák
 E Bolsas para desperdicios

METAL



VOREL

No.	l	pcs / packing	µm	
10004	60	15	30	30
10014	120	10	40	25

PL Worki na odpady z nadrukiem
 GB Waste bags
 D Müllbeutel
 RUS Пакеты для мусора

CZ Pytle na odpad
 RO Saci gunoi
 H Szemeteszsák
 E Bolsas para desperdicios

OTHER INNE



VOREL

No.	l	pcs / packing	µm	
10005	60	15	30	30
10015	120	10	40	25

PL Płandeka
 GB Tarpaulin
 D Plane
 RUS Тент

CZ Plachta
 RO Husă
 H PONYVA
 E Toldo

57 g/m²



VOREL

No.	m	g/m ²	
85122	2x3	57	30
85123	3x5	57	20
85124	4x5	57	10
85125	4x6	57	8
85126	5x8	57	5
85128	6x10	57	3
85129	8x12	57	2
85130	10x15	57	2

PL Płandeka
 GB Tarpaulin
 D Plane
 RUS Тент

CZ Plachta
 RO Husă
 H PONYVA
 E Toldo

75 g/m²



VOREL

No.	m	g/m ²	
85112	2x3	75	30
85113	3x5	75	10
85114	4x5	75	10
85115	4x6	75	8
85116	5x8	75	5
85118	6x10	75	3
85119	8x12	75	2
85120	10x15	75	2

PL Płandeka
 GB Tarpaulin
 D Plane
 RUS Тент

CZ Plachta
 RO Husă
 H PONYVA
 E Toldo

90 g/m²



VOREL

No.	m	g/m ²	
85020	2x3	90	30
85030	3x5	90	18
85040	4x5	90	9
85050	4x6	90	10
85060	5x8	90	5
85080	6x10	90	4
85090	8x12	90	2
85100	10x15	90	1

PL Urządzenie do filtrowania popiołu
GB Ash filter
D Aschenfilter
RUS Устройство для фильтрования золы
CZ Zařízení na vysávání popela
RO Dispozitiv pt. filtrat cenușă
H Hamuszűrő berendezés
E Dispositivo para filtrar cenizas



18L **ZINC STEEL STAL CYNKOWA**
1m **Al 23 cm**
3.8cm

VOREL

No.		
72920		2

PL Odkurzacz do popiołu
GB Ash filter
D Aschesauger
RUS Пылесос для золы
CZ Vysavač na popel
RO Aspirator pt. cenușă
H Porszívó korom eltávolítására
E Aspiradora para cenizas



230V~50Hz **800 W**
40°C (max) **1m**
Al 23 cm **16 kPa (max)**
18L **2.7cm**

VOREL

No.	W	
72930	800	1

PL Filtr z korpusem
GB Pet filter and plastic filter
D Filter mit Gehäuse/Устройство для
RUS Фильтр с корпусом
CZ Filtr s tělesem
RO Filtru cu carcasă
H Szűrő házzal
E Filtro con el armazón



FOR/DLA 72920

VOREL

No.	for / dla	
72921	72920	64

PL Filtr **CZ** Filtr
GB Filter **RO** Filtru
D Filter **H** Szűrő
RUS Фильтр **E** Filtro



FOR/DLA 72930

VOREL

No.	for / dla	
72931	72930	24

PL Wąż metalowy
GB Metal hose
D Metallschlauch
RUS Металлический шланг

CZ Kovová hadice
RO Furtun metalic
H Hajlékony, fém tömlő
E Manguera de metal



FOR/DLA 72920 **1m**
ZINC STEEL STAL CYNKOWA **3.8cm**

VOREL

No.	for / dla	
72922	72920	20

PL Wąż metalowy
GB Metal hose
D Metallschlauch
RUS Металлический шланг

CZ Kovová hadice
RO Furtun metalic
H Hajlékony, fém tömlő
E Manguera de metal



FOR/DLA 72930 **1m**
3.8cm **Al 23 cm**

VOREL

No.	for / dla	
72932	72930	20

PL Pompa syfonowa
GB Syphon pump
D Siphon-pumpe
RUS Сифонный насос

CZ Pumpa syfónová
RO Pompa manuală pt. combustibil
H Szifon pumpa
E Bomba de sífon



6.2 l/min
 $\varnothing 14 \times 390\text{mm}$
 $\varnothing 12 \times 540\text{mm}$
5-50 °C

VOREL

No.		
78020		30/60

PL Pompa syfonowa
GB Syphon pump
D Siphon-pumpe
RUS Сифонный насос

CZ Pumpa syfónová
RO Pompa manuală pt. combustibil
H Szifon pumpa
E Bomba de sífon



10 l/min
 $\varnothing 25 \times 850\text{mm}$
 $\varnothing 22 \times 130\text{mm}$
5-50 °C

VOREL

No.		
78021		24

PL Pompa wielofunkcyjna
GB Multi-purpose pump
D Multifunktionale Pumpe
RUS Многофункциональный насос

CZ Univerzální pumpička
RO Pompă multifuncțională
H Többfunkciós szivattyú
E Bomba multilúsos



VOREL

No.			
78022			6/24

PL Pistolet do udrażniania rur
GB Drain cleaner
D Pistole zum Reinigen von Röhren
RUS Пистолет для прочистки труб
CZ Pistole na čištění trubek
RO Pistol pt. curățarea țevilor
H Csőtisztító pisztoly
E Pistola destapacaños



VOREL



No.	Ø (mm)	
55500	135	10

PL Pompa do udrażniania kanalizacji
GB Drain suction pump
D Hochdruck-Rohrreiner
RUS Ручной насос для прочистки труб

CZ Čerpadlo na čištění trubek
RO Pompă pt. curățarea țeilor
H Csőtisztító szivattyú
E El desague del fregadero limpiador



VOREL



No.	Ø (mm)	
55505	65; 155	24

PL Przepychacz do udrażniania kanalizacji
GB Pipe cleaner
D Raumdorn zum Reinigen der Kanalisation
RUS Поршень для прочистки канализации

CZ Tlakový čistič kanalizace
RO Piston pt. deblocarea canalizării
H Lefolyótisztító pumpa
E Bomba destapacaños



VOREL



No.	L (cm)	
55530	50	40

PL Przepychacz do udrażniania kanalizacji
GB Pipe cleaner
D Hand-Rohrreinigungsspirale
RUS Поршень для прочистки канализации

CZ Tlakový čistič kanalizace
RO Piston pt. deblocarea canalizării
H Lefolyótisztító pumpa
E Bomba destapacaños



VOREL



No.	L (cm)	pcs	
55531	65	2	36

PL Spirala kanalizacyjna
GB Drain auger
D Hand-Rohrreinigungsspirale
RUS Трос сантехнический пружинный

CZ Spirála kanalizační
RO Dispozitiv de desfundat scurgere
H Csőtisztító spirál
E Desatascador espiral



VOREL



No.	Ø (mm)	L (m)	
55541	5	1.5	20/80
55542	6	3	18/36

PL Spirala kanalizacyjna
GB Drain auger
D Hand-Rohrreinigungsspirale
RUS Трос сантехнический пружинный

CZ Spirála kanalizační
RO Dispozitiv de desfundat scurgere
H Csőtisztító spirál
E Desatascador espiral



VOREL



No.	Ø (mm)	L (m)	
55544	9	5	5/10
55545	9	10	4/8

PL Wazelina techniczna
GB Vaseline
D Vaseline
RUS Вазелин технический

CZ Technická vazelina
RO Vaselină tehnică
H Műszaki vazelin
E Vaselina tecnica



VOREL

No.	ml	
86700	50	50
86701	100	50

PL Kółko stałe
GB Fixed caster
D Bockrolle
RUS Ролик с стационарной опорой
CZ Pevné kolečko
RO Roata de carucior fixa
H Szállítógörgők
E Rueda fija



TEMPERATURE TOLERANCE
 OPORNOSC NA TEMPERATURE
-10°C ÷ +50°C

RUBBER
 GUMA

ROLLER BEARING
 ŁOŻYSKO WALECZKOWE

VOREL

No.	wheel diameter / średnica kółka (mm)	wheel width / szerokość kółka (mm)	caster height / wysokość kółka (mm)	load capacity / obciążalność (kg)	
87301	75	23	97	40	60
87302	100	27	130	60	32
87303	125	34	155	100	22
87305	160	40	195	130	10
87307	200	46	235	150	8

PL Kółko skrętne z czarną gumą
GB Swivel caster
D Lenkrolle mit Feststeller
RUS Ролик с вращающейся опорой
CZ Otočné kolečko
RO Roata de carucior mobila
H Szállítógörgők
E Rueda giratoria con freno



TEMPERATURE TOLERANCE
 OPORNOSC NA TEMPERATURE
-10°C ÷ +50°C

RUBBER
 GUMA

ROLLER BEARING
 ŁOŻYSKO WALECZKOWE

VOREL

No.	wheel diameter / średnica kółka (mm)	wheel width / szerokość kółka (mm)	caster height / wysokość kółka (mm)	load capacity / obciążalność (kg)	
87311	75	23	97	40	48
87312	100	27	130	60	26
87313	125	34	155	100	20
87315	160	40	195	130	10
87317	200	46	235	150	6

PL Kółko skrętne z czarną gumą
GB Swivel caster
D Lenkrolle mit Feststeller
RUS Ролик с вращающейся опорой
CZ Otočné kolečko
RO Roata de carucior mobila
H Szállítógörgők
E Rueda giratoria con freno



TEMPERATURE TOLERANCE
 OPORNOSC NA TEMPERATURE
-10°C ÷ +50°C

RUBBER
 GUMA

DOUBLE BRAKE
 PODWÓJNY HAMULEC

ROLLER BEARING
 ŁOŻYSKO WALECZKOWE

VOREL

No.	wheel diameter / średnica kółka (mm)	wheel width / szerokość kółka (mm)	caster height / wysokość kółka (mm)	load capacity / obciążalność (kg)	
87321	75	23	97	40	40
87322	100	27	130	60	20
87323	125	34	155	100	16
87325	160	40	195	130	8
87327	200	46	235	150	6

PL Kółko skrętne z czarną gumą
GB Swivel caster
D Lenkrolle mit Feststeller
RUS Ролик с вращающейся опорой
CZ Otočné kolečko
RO Roata de carucior mobila
H Szállítógörgők
E Rueda giratoria con freno



TEMPERATURE TOLERANCE
 OPORNOSC NA TEMPERATURE
-10°C ÷ +50°C

RUBBER
 GUMA

DOUBLE BRAKE
 PODWÓJNY HAMULEC

ROLLER BEARING
 ŁOŻYSKO WALECZKOWE

THREADED STEM
 TRZPIEŃ ŚWITNOWNY

VOREL

No.	wheel diameter / średnica kółka (mm)	wheel width / szerokość kółka (mm)	caster height / wysokość kółka (mm)	load capacity / obciążalność (kg)	
87331	75	22	97	40	38
87332	100	26	130	60	24
87333	125	33	153	100	18
87335	160	39	190	130	8
87337	200	44	230	150	6

PL Kółko skrętne z czarną gumą
GB Swivel caster
D Lenkrolle mit Feststeller
RUS Ролик с вращающейся опорой
CZ Otočné kolečko
RO Roata de carucior mobila
H Szállítógörgők
E Rueda giratoria con freno



TEMPERATURE TOLERANCE
 OPORNOSC NA TEMPERATURE
-10°C ÷ +50°C

RUBBER
 GUMA

PLAIN BEARING
 ŁOŻYSKO ŚLIZGOWE

VOREL

No.	wheel diameter / średnica kółka (mm)	wheel width / szerokość kółka (mm)	caster height / wysokość kółka (mm)	load capacity / obciążalność (kg)	
87351	50	16	72	20	140
87352	75	21	104	30	60
87353	100	26	134	45	38
87354	125	27	161	50	25

PL Kółko skrętne z szarą gumą
GB Swivel caster
D Lenkrolle mit Feststeller
RUS Ролик с вращающейся опорой
CZ Otočné kolečko
RO Roata de carucior mobila
H Szállítógörgők
E Rueda giratoria con freno



TEMPERATURE TOLERANCE
 OPORNOSC NA TEMPERATURE
-10°C ÷ +50°C

RUBBER
 GUMA

PLAIN BEARING
 ŁOŻYSKO ŚLIZGOWE

VOREL

No.	wheel diameter / średnica kółka (mm)	wheel width / szerokość kółka (mm)	caster height / wysokość kółka (mm)	load capacity / obciążalność (kg)	
87361	50	16	72	20	100
87362	75	21	104	30	52
87363	100	26	134	45	28
87364	125	27	161	50	24

PL Kółko skrętne z szarą gumą
GB Swivel caster
D Lenkrolle mit Feststeller
RUS Ролик с вращающейся опорой

CZ Otočné kolečko
RO Roata de carucior mobila
H Szállítógörgők
E Rueda giratoria con freno



TEMPERATURE TOLERANCE
 OPORNOSC NA TEMPERATURE
-10°C ÷ +50°C

RUBBER
 GUMA

BOLT HOLE
 OTWÓR MOCUJĄCY

PLAIN BEARING
 ŁOŻYSKO ŚLIZGOWE

VOREL

No.	wheel diameter / średnica kółka (mm)	wheel width / szerokość kółka (mm)	caster height / wysokość kółka (mm)	load capacity / obciążalność (kg)	
87371	50	16	70	20	120
87372	75	21	101	30	64
87373	100	26	132	45	34
87374	125	27	158	50	24

PL Kółko skrętne z szarą gumą
GB Swivel caster
D Lenkrolle mit Feststeller
RUS Ролик с вращающейся опорой

CZ Otočné kolečko
RO Roata de carucior mobila
H Szállítógörgők
E Rueda giratoria con freno



TEMPERATURE TOLERANCE
 OPORNOSC NA TEMPERATURE
-10°C ÷ +50°C

RUBBER
 GUMA

BRAKE
 HAMULEC

PLAIN BEARING
 ŁOŻYSKO ŚLIZGOWE

VOREL

No.	wheel diameter / średnica kółka (mm)	wheel width / szerokość kółka (mm)	caster height / wysokość kółka (mm)	load capacity / obciążalność (kg)	
87381	50	16	72	20	96
87382	75	21	104	30	50
87383	100	26	134	45	26
87384	125	27	161	50	22

PL Kółko stałe
GB Fixed caster
D Bockrolle
RUS Ролик с стационарной опорой

CZ Pevné kolečko
RO Roata de carucior fixa
H Szállítógörgők
E Rueda fija

TEMPERATURE TOLERANCE
ODPORNOŚĆ NA TEMPERATURĘ
-10°C ÷ +50°C

POLYPROPYLENE
POLIPROPYLEN

POM BEARING
ŁOŻYSKO POM



VOREL

No.	wheel diameter / średnica kółka (mm)	wheel width / szerokość kółka (mm)	caster height / wysokość kółka (mm)	load capacity / obciążalność (kg)	
87391	40	17	54	20	280
87392	50	22	65	25	130
87393	65	23	84	30	90

PL Kółko skrętnie
GB Swivel caster
D Lenkrolle mit Feststeller
RUS Ролик с вращающейся опорой

CZ Otočné kolečko
RO Roata de carucior mobila
H Szállítógörgők
E Rueda giratoria con freno

TEMPERATURE TOLERANCE
ODPORNOŚĆ NA TEMPERATURĘ
-10°C ÷ +50°C

POLYPROPYLENE
POLIPROPYLEN

POM BEARING
ŁOŻYSKO POM



VOREL

No.	wheel diameter / średnica kółka (mm)	wheel width / szerokość kółka (mm)	caster height / wysokość kółka (mm)	load capacity / obciążalność (kg)	
87401	40	17	54	20	260
87402	50	22	65	25	120
87403	65	23	84	30	78

PL Kółko skrętnie
GB Swivel caster
D Lenkrolle mit Feststeller
RUS Ролик с вращающейся опорой

CZ Otočné kolečko
RO Roata de carucior mobila
H Szállítógörgők
E Rueda giratoria con freno

TEMPERATURE TOLERANCE
ODPORNOŚĆ NA TEMPERATURĘ
-10°C ÷ +50°C

POLYPROPYLENE
POLIPROPYLEN

BRAKE
HAMULEC

POM BEARING
ŁOŻYSKO POM



VOREL

No.	wheel diameter / średnica kółka (mm)	wheel width / szerokość kółka (mm)	caster height / wysokość kółka (mm)	load capacity / obciążalność (kg)	
87411	40	17	54	20	230
87412	50	22	65	25	110
87413	65	23	84	30	72

PL Kółko stałe
GB Fixed caster
D Bockrolle
RUS Ролик с стационарной опорой

CZ Pevné kolečko
RO Roata de carucior fixa
H Szállítógörgők
E Rueda fija

TEMPERATURE TOLERANCE
ODPORNOŚĆ NA TEMPERATURĘ
-15°C ÷ +80°C

POLYAMIDE
POLIAMID

ROLLER BEARING
ŁOŻYSKO WALECZKOWE



VOREL

No.	wheel diameter / średnica kółka (mm)	wheel width / szerokość kółka (mm)	caster height / wysokość kółka (mm)	load capacity / obciążalność (kg)	
87421	75	23	97	40	60
87422	100	31	130	60	38
87423	125	33	155	100	28
87425	160	40	195	130	12
87427	200	40	235	150	8

PL Kółko skrętnie
GB Swivel caster
D Lenkrolle mit Feststeller
RUS Ролик с вращающейся опорой

CZ Otočné kolečko
RO Roata de carucior mobila
H Szállítógörgők
E Rueda giratoria con freno

TEMPERATURE TOLERANCE
ODPORNOŚĆ NA TEMPERATURĘ
-15°C ÷ +80°C

POLYAMIDE
POLIAMID

ROLLER BEARING
ŁOŻYSKO WALECZKOWE



VOREL

No.	wheel diameter / średnica kółka (mm)	wheel width / szerokość kółka (mm)	caster height / wysokość kółka (mm)	load capacity / obciążalność (kg)	
87431	75	23	97	40	60
87432	100	31	130	60	32
87433	125	33	155	100	26
87435	160	40	195	130	12
87437	200	40	235	150	8

PL Kółko skrętnie
GB Swivel caster
D Lenkrolle mit Feststeller
RUS Ролик с вращающейся опорой

CZ Otočné kolečko
RO Roata de carucior mobila
H Szállítógörgők
E Rueda giratoria con freno

TEMPERATURE TOLERANCE
ODPORNOŚĆ NA TEMPERATURĘ
-15°C ÷ +80°C

POLYAMIDE
POLIAMID

DOUBLE BRAKE
PODWÓJNY HAMULEC

ROLLER BEARING
ŁOŻYSKO WALECZKOWE



VOREL

No.	wheel diameter / średnica kółka (mm)	wheel width / szerokość kółka (mm)	caster height / wysokość kółka (mm)	load capacity / obciążalność (kg)	
87441	75	23	97	40	50
87442	100	31	130	60	24
87443	125	33	155	100	22
87445	160	40	195	130	10
87447	200	40	235	150	8

PL Kółko czarna guma
GB Wheel
D Transportrad
RUS Ролик

CZ Kolečko
RO Roata de carucior
H Onálló görgők
E Rueda

TEMPERATURE TOLERANCE
ODPORNOŚĆ NA TEMPERATURĘ
-10°C ÷ +50°C

RUBBER
GUMA

ROLLER BEARING
ŁOŻYSKO WALECZKOWE



VOREL

No.	wheel diameter / średnica kółka (mm)	wheel width / szerokość kółka (mm)	axle / oś	load capacity / obciążalność (kg)	
87451	75	22	Ø12mm x 30mm	40	150
87452	100	26	Ø12mm x 40mm	60	66
87453	125	33	Ø15mm x 40mm	100	36
87454	150	39	Ø20mm x 55mm	110	22
87455	160	39	Ø20mm x 55mm	130	20
87456	200	44	Ø20/25mm x 55mm	150	12
87457	250	48	Ø20/25mm x 55mm	180	8

PL Kółko łożyskowane
GB Wheel
D Transportrad
RUS Ролик

CZ Kolečko
RO Roata de carucior
H Onálló görgők
E Rueda

TEMPERATURE TOLERANCE
ODPORNOŚĆ NA TEMPERATURĘ
-10°C ÷ +50°C

RUBBER
GUMA

ROLLER BEARING
ŁOŻYSKO WALECZKOWE





VOREL

No.	wheel diameter / średnica kółka (mm)	wheel width / szerokość kółka (mm)	axle / oś	load capacity / obciążalność (kg)	
87461	80	24	Ø12mm x 37mm	60	96
87462	100	28	Ø12mm x 37mm	90	64
87463	125	35	Ø15mm x 48mm	140	32
87465	160	38	Ø20mm x 57mm	160	20
87467	200	49	Ø20mm x 57mm	180	12

PL Uszczelka do okien i drzwi
GB Seal for windows and doors
D Dichtung für Fenster und Türen
RUS Уплотнители для окон и дверей

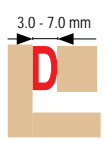
CZ Těsnění oken a dveří
RO Seal pt. ferestre si usi
H Seal az ablakok és ajtók
E Sellar para ventanas y puertas







S/PAK

No.	dimensions / wymiary (mm)	L (m)	type / profil	colour / kolor	box
76752	9x7.4	6	D	○	24
76762	9x7.4	6	D	●	24

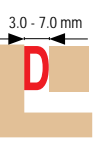
PL Uszczelka do okien i drzwi
GB Seal for windows and doors
D Dichtung für Fenster und Türen
RUS Уплотнители для окон и дверей

CZ Těsnění oken a dveří
RO Seal pt. ferestre si usi
H Seal az ablakok és ajtók
E Sellar para ventanas y puertas







S/PAK

No.	dimensions / wymiary (mm)	L (m)	type / profil	colour / kolor	box
76757	9x7.4	100	D	○	6
76767	9x7.4	100	D	●	6

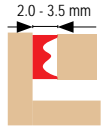
PL Uszczelka do okien i drzwi
GB Seal for windows and doors
D Dichtung für Fenster und Türen
RUS Уплотнители для окон и дверей

CZ Těsnění oken a dveří
RO Seal pt. ferestre si usi
H Seal az ablakok és ajtók
E Sellar para ventanas y puertas







S/PAK

No.	dimensions / wymiary (mm)	L (m)	type / profil	colour / kolor	box
76750	9x4	6	E	○	24
76760	9x4	6	E	●	24

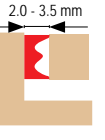
PL Uszczelka do okien i drzwi
GB Seal for windows and doors
D Dichtung für Fenster und Türen
RUS Уплотнители для окон и дверей

CZ Těsnění oken a dveří
RO Seal pt. ferestre si usi
H Seal az ablakok és ajtók
E Sellar para ventanas y puertas

S/PAK

No.	dimensions / wymiary (mm)	L (m)	type / profil	colour / kolor	box
76755	9x4	150	E	○	6
76765	9x4	150	E	●	6

PL Uszczelka do okien i drzwi
GB Seal for windows and doors
D Dichtung für Fenster und Türen
RUS Уплотнители для окон и дверей

CZ Těsnění oken a dveří
RO Seal pt. ferestre si usi
H Seal az ablakok és ajtók
E Sellar para ventanas y puertas







S/PAK

No.	dimensions / wymiary (mm)	L (m)	type / profil	colour / kolor	box
76751	9x5.5	6	P	○	24
76761	9x5.5	6	P	●	24

PL Uszczelka do okien i drzwi
GB Seal for windows and doors
D Dichtung für Fenster und Türen
RUS Уплотнители для окон и дверей

CZ Těsnění oken a dveří
RO Seal pt. ferestre si usi
H Seal az ablakok és ajtók
E Sellar para ventanas y puertas







S/PAK

No.	dimensions / wymiary (mm)	L (m)	type / profil	colour / kolor	box
76756	9x5.5	100	P	○	6
76766	9x5.5	100	P	●	6

PL Podkładka samoprzylepna, korkowa
GB Self-adhesive pad for furniture
D Klebegleiter für Möbel
RUS Самоклеящая подкладка под мебель

CZ 3 R30BAND VCP R05R SRGQ E VVN
RO Adeziv pad sub mobilier
H Öntapadó, bútörüláb alátét
E Arandela adhesiva bajo los muebles





VOREL

No.	Ø (mm)	pcs	box
74802	20	20	60/720
74804	28	12	60/720

PL Podkładka samoprzylepna, korkowa
GB Self-adhesive pad for furniture
D Klebegleiter für Möbel
RUS Самоклеящая подкладка под мебель

CZ 3 R30BAND VCP R05R SRGQ E VVN
RO Adeziv pad sub mobilier
H Öntapadó, bútörüláb alátét
E Arandela adhesiva bajo los muebles

VOREL

No.	mm	pcs	box
74812	100x120	1	60/720

PL Podkładka samoprzylepna, antypoślizgowa
GB Self-adhesive pad for furniture
D Klebegleiter für Möbel
RUS Самоклеящая подкладка под мебель

CZ 3 RCBAND VDP RBSIF SRGQ E/WN
RO Adeziv pad sub mobilier
H Őntapadó, bútorláb alátét
E Arandela adhesiva bajo los muebles

NON-SLIP
ANTY-
POŚLIZGOWY

No.	Ø (mm)	pcs	
74816	10	24	60/720
74818	20	20	60/720
74820	28	12	60/720

PL Podkładka samoprzylepna, antypoślizgowa
GB Self-adhesive pad for furniture
D Klebegleiter für Möbel
RUS Самоклеящая подкладка под мебель

CZ 3 RCBAND VDP RBSIF SRGQ E/WN
RO Adeziv pad sub mobilier
H Őntapadó, bútorláb alátét
E Arandela adhesiva bajo los muebles

NON-SLIP
ANTY-
POŚLIZGOWY

No.	mm	pcs	
74828	100x120	1	60/720

PL Podkładka samoprzylepna z włókniny
GB Self-adhesive pad for furniture
D Klebegleiter für Möbel
RUS Самоклеящая подкладка под мебель

CZ 3 RCBAND VDP RBSIF SRGQ E/WN
RO Adeziv pad sub mobilier
H Őntapadó, bútorláb alátét
E Arandela adhesiva bajo los muebles

NONWOVEN
WŁÓKNINA

No.	Ø (mm)	pcs	
74831	20	20	60/720
74833	28	12	60/720
74835	40	4	60/720
74836	50	2	60/720

PL Podkładka samoprzylepna z włókniny mix
GB Self-adhesive pad for furniture
D Klebegleiter für Möbel
RUS Самоклеящая подкладка под мебель

CZ 3 RCBAND VDP RBSIF SRGQ E/WN
RO Adeziv pad sub mobilier
H Őntapadó, bútorláb alátét
E Arandela adhesiva bajo los muebles

NONWOVEN
WŁÓKNINA

No.	Ø (mm)	pcs	
74838	20; 38	12	60/720

PL Podkładka samoprzylepna z włókniny
GB Self-adhesive pad for furniture
D Klebegleiter für Möbel
RUS Самоклеящая подкладка под мебель

CZ 3 RCBAND VDP RBSIF SRGQ E/WN
RO Adeziv pad sub mobilier
H Őntapadó, bútorláb alátét
E Arandela adhesiva bajo los muebles

NONWOVEN
WŁÓKNINA

No.	mm	pcs	
74841	20x20	20	60/720
74843	28x28	12	60/720

PL Podkładka samoprzylepna z włókniny
GB Self-adhesive pad for furniture
D Klebegleiter für Möbel
RUS Самоклеящая подкладка под мебель

CZ 3 RCBAND VDP RBSIF SRGQ E/WN
RO Adeziv pad sub mobilier
H Őntapadó, bútorláb alátét
E Arandela adhesiva bajo los muebles

NONWOVEN
WŁÓKNINA

No.	mm	pcs	
74846	20x45	10	60/720

PL Podkładka samoprzylepna z włókniny
GB Self-adhesive pad for furniture
D Klebegleiter für Möbel
RUS Самоклеящая подкладка под мебель

CZ 3 RCBAND VDP RBSIF SRGQ E/WN
RO Adeziv pad sub mobilier
H Őntapadó, bútorláb alátét
E Arandela adhesiva bajo los muebles

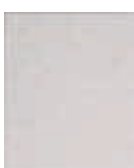
NONWOVEN
WŁÓKNINA

No.	mm	pcs	
74849	100x120	1	60/720

PL Podkładka samoprzylepna z włókniny mix
GB Self-adhesive pad for furniture
D Klebegleiter für Möbel
RUS Самоклеящая подкладка под мебель

CZ 3 RCBAND VDP RBSIF SRGQ E/WN
RO Adeziv pad sub mobilier
H Őntapadó, bútorláb alátét
E Arandela adhesiva bajo los muebles

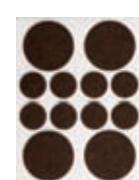
NONWOVEN
WŁÓKNINA

No.	Ø (mm)	pcs	
74858	20; 38	12	60/720

PL Podkładka samoprzylepna z włókniny
GB Self-adhesive pad for furniture
D Klebegleiter für Möbel
RUS Самоклеящая подкладка под мебель

CZ 3R02AND VDP R05R SRGQ E1WN
RO Adeziv pad sub mobilier
H Öntapadó, bútörláb alátét
E Arandela adhesiva bajo los muebles

NONWOVEN
WŁÓKNINA



VOREL

No.	mm	pcs	
74861	20x20	20	60/720
74863	28x28	12	60/720

PL Podkładka samoprzylepna z włókniny
GB Self-adhesive pad for furniture
D Klebegleiter für Möbel
RUS Самоклеящая подкладка под мебель

CZ 3R02AND VDP R05R SRGQ E1WN
RO Adeziv pad sub mobilier
H Öntapadó, bútörláb alátét
E Arandela adhesiva bajo los muebles

NONWOVEN
WŁÓKNINA



VOREL

No.	Ø (mm)	pcs	
74851	20	20	60/720
74853	28	12	60/720
74855	40	4	60/720
74856	50	2	60/720

PL Podkładka samoprzylepna z włókniny
GB Self-adhesive pad for furniture
D Klebegleiter für Möbel
RUS Самоклеящая подкладка под мебель

CZ 3R02AND VDP R05R SRGQ E1WN
RO Adeziv pad sub mobilier
H Öntapadó, bútörláb alátét
E Arandela adhesiva bajo los muebles

NONWOVEN
WŁÓKNINA



VOREL

No.	mm	pcs	
74866	20x45	10	60/720

PL Podkładka samoprzylepna z włókniny
GB Self-adhesive pad for furniture
D Klebegleiter für Möbel
RUS Самоклеящая подкладка под мебель

CZ 3R02AND VDP R05R SRGQ E1WN
RO Adeziv pad sub mobilier
H Öntapadó, bútörláb alátét
E Arandela adhesiva bajo los muebles

NONWOVEN
WŁÓKNINA



VOREL

No.	mm	pcs	
74869	100x120	1	60/720

PL Podkładka samoprzylepna, antypoślizgowa
GB Self-adhesive pad for furniture
D Klebegleiter für Möbel
RUS Самоклеящая подкладка под мебель

CZ 3R02AND VDP R05R SRGQ E1WN
RO Adeziv pad sub mobilier
H Öntapadó, bútörláb alátét
E Arandela adhesiva bajo los muebles

NON-SLIP
ANTY-POŚLIZGOWY



VOREL

No.	Ø (mm)	pcs	
74881	18	32	24/432
74882	25	18	24/432
74883	38	8	24/432

PL Podkładka samoprzylepna, antypoślizgowa
GB Self-adhesive pad for furniture
D Klebegleiter für Möbel
RUS Самоклеящая подкладка под мебель

CZ 3R02AND VDP R05R SRGQ E1WN
RO Adeziv pad sub mobilier
H Öntapadó, bútörláb alátét
E Arandela adhesiva bajo los muebles

NON-SLIP
ANTY-POŚLIZGOWY



VOREL

No.	Ø (mm)	pcs	
74885	18	32	24/432
74886	25	18	24/432
74887	38	8	24/432

PL Podkładka samoprzylepna, antypoślizgowa
GB Self-adhesive pad for furniture
D Klebegleiter für Möbel
RUS Самоклеящая подкладка под мебель

CZ 3R02AND VDP R05R SRGQ E1WN
RO Adeziv pad sub mobilier
H Öntapadó, bútörláb alátét
E Arandela adhesiva bajo los muebles

NON-SLIP
ANTY-POŚLIZGOWY



VOREL

No.	Ø (mm)	pcs	
74891	18x18	32	24/432
74892	25x25	18	24/432
74893	38x38	8	24/432
74894	85x85	2	24/432

PL Podkładka samoprzylepna, antypoślizgowa
GB Self-adhesive pad for furniture
D Klebegleiter für Möbel
RUS Самоклеящая подкладка под мебель

CZ 3R02AND VDP R05R SRGQ E1WN
RO Adeziv pad sub mobilier
H Öntapadó, bútörláb alátét
E Arandela adhesiva bajo los muebles

NON-SLIP
ANTY-POŚLIZGOWY



VOREL

No.	Ø (mm)	pcs	
74895	18x18	32	24/432
74896	25x25	18	24/432
74897	38x38	8	24/432
74898	85x85	2	24/432

PL Podkładka samoprzylepna, antypoślizgowa
GB Self-adhesive pad for furniture
D Klebegleiter für Möbel
RUS Самоклеящая подкладка под мебель

CZ 3 ROZMĚRY ROKESR SRGCI E/VN
RO Adeziv pad sub mobilier
H Öntapadó, bútörlábat alátét
E Arandela adhesiva bajo los muebles

NON-SLIP
ANTY-
POŚLIZGOWY

VOREL

No.	Ø (mm)	pcs	
74901	18x18	32	24/432
74902	25x25	18	24/432
74903	38x38	8	24/432
74904	85x85	2	24/432

PL Podkładka samoprzylepna, silikonowa
GB Self-adhesive silicone pad for furniture
D Klebegleiter für Möbel
RUS Самоклеящая подкладка под мебель

CZ 3 ROZMĚRY ROKESR SRGCI E/VN
RO Adeziv pad sub mobilier
H Öntapadó, bútörlábat alátét
E Arandela adhesiva bajo los muebles

SILICONE
SILIKON

VOREL

No.	Ø (mm)	pcs	
74910	8	25	32/576
74911	10	20	32/576
74912	13	12	32/576
74913	15	9	32/576
74914	19	6	32/576

PL Podkładki plastikowo-filcowe na gwóźdź
GB Felt & plastic furniture glides
D Kunststoff- und Filzgleiter zum Nageln
RUS Подкладки пластиковые фильцевые на гвоздь
CZ 3 ROZMĚRY SRGBAN VSOMCD Křebik
RO Șalbe din plastic-păslă pt. cuie
H Műanyag-filc alátét szöghöz
E Arandelas de plástico y fieltro con clave

FELT
PLASTIC
FILC
PLASTIK

VOREL

No.	Ø (mm)	pcs	
74920	17	16	16/288
74921	20	12	16/288
74922	24	12	16/288
74923	28	8	16/256
74924	30	8	16/256

PL Podkładki plastikowo-filcowe na kolek
GB Felt & plastic furniture glides
D Kunststoff- und Filzgleiter für Rundbolzen
RUS Подкладки пластиковые фильцевые на штифт
CZ 3 ROZMĚRY SRGBAN VSOMCD Křebik
RO Șalbe din plastic-păslă pt. bolt
H Műanyag-filc alátét tiplhez
E Arandelas de plástico y fieltro con estaquilla

FELT
PLASTIC
FILC
PLASTIK

VOREL

No.	Ø (mm)	pcs	
74926	22	12	16/288
74927	26	8	16/288
74928	37	4	16/288

PL Podkładka samoprzylepna plastikowo-plankowa
GB Self-adhesive plastic glides
D Klebegleiter für Möbel
RUS Самоклеящая подкладка под мебель
CZ 3 ROZMĚRY ROKESR SRGCI E/VN
RO Adeziv pad sub mobilier
H Öntapadó, bútörlábat alátét
E Arandela adhesiva bajo los muebles

PLASTIC
PLASTIK

VOREL

No.	Ø (mm)	pcs	
74930	18	12	24/432
74931	23	8	24/432
74932	28	4	24/432
74933	38	4	24/432

PL Podkładki plastikowe na gwóźdź
GB Plastic furniture glides
D Kunststoffgleiter zum Nageln
RUS Подкладки пластиковые на гвоздь

CZ 3 ROZMĚRY SRGBAN CD Křebik
RO Șalbe din plastic pt. cuie
H Műanyag alátét szöghöz
E Arandelas de plástico con clave

PLASTIC
PLASTIK

VOREL

No.	Ø (mm)	pcs	
74935	18	12	16/288
74936	20	12	16/288
74937	25	8	16/288

PL Podkładki plastikowe na wkręt
GB Plastic furniture glides
D Kunststoffgleiter zum Anschrauben
RUS Подкладки пластиковые на шуруп
CZ 3 ROZMĚRY SRGBAN CD YXW
RO Șalbe din plastic pt. șurub
H Műanyag alátét csavarhoz
E Arandelas de plástico con tornillo

PLASTIC
PLASTIK

VOREL

No.	Ø (mm)	pcs	
74940	20	8	24/432
74941	26	4	24/432

PL Podkładki plastikowe na wkręt
GB Plastic furniture glides
D Kunststoffgleiter zum Anschrauben
RUS Подкладки пластиковые на шуруп

CZ 3 ROZMĚRY SRGBAN CD YXW
RO Șalbe din plastic pt. șurub
H Műanyag alátét csavarhoz
E Arandelas de plástico con tornillo

PLASTIC
PLASTIK

VOREL

No.	Ø (mm)	pcs	
74944	20	8	24/432
74945	26	4	24/432

- PL Klíny pod meble
- GB Levelling wedge
- D Kelle für Möbel
- RUS Клинья под мебель
- CZ Klíny pod nábytek
- RO Pene pt. mobilă
- H Bütörék
- E Cuña para muebles



No.	pcs	
74960	4	16/288

- PL Stolek plastikowy
- GB Plastic stool
- D Kunststoff Hocker
- RUS Пластиковый табурет
- CZ Plastová stolička
- RO Scaun de plastic
- H Műanyag széket
- E Taburete de plástico



No.	size / rozmiar (cm)	
75915	30x20x21	10/20

- PL Stolek plastikowy
- GB Plastic stool
- D Kunststoff Hocker
- RUS Пластиковый табурет
- CZ Plastová stolička
- RO Scaun de plastic
- H Műanyag széket
- E Taburete de plástico



No.	size / rozmiar (cm)	
75916	30x20x21	10/20

- PL Haczyki naścienne samoprzylepne
- GB Self-adhesive hanging hooks
- D Selbstklebende Wandhaken
- RUS Крючки настенные на липучках
- CZ Háčky nástěnné samolepící
- RO Cârlițe perete autocolante
- H Műanyag, fall kampó, öntapadós
- E Ganchos adhesivos para pared



No.	max (kg)	pcs	
74730	1.0	3	12/144

- PL Haczyki naścienne samoprzylepne
- GB Self-adhesive hanging hooks
- D Selbstklebende Wandhaken
- RUS Крючки настенные на липучках
- CZ Háčky nástěnné samolepící
- RO Cârlițe perete autocolante
- H Műanyag, fall kampó, öntapadós
- E Ganchos adhesivos para pared



No.	max (kg)	pcs	
74731	0.8	3	12/216

- PL Haczyki naścienne samoprzylepne
- GB Self-adhesive hanging hooks
- D Selbstklebende Wandhaken
- RUS Крючки настенные на липучках
- CZ Háčky nástěnné samolepící
- RO Cârlițe perete autocolante
- H Műanyag, fall kampó, öntapadós
- E Ganchos adhesivos para pared



No.	max (kg)	pcs	
74732	1.0	3	16/192

- PL Haczyki naścienne samoprzylepne
- GB Self-adhesive hanging hooks
- D Selbstklebende Wandhaken
- RUS Крючки настенные на липучках
- CZ Háčky nástěnné samolepící
- RO Cârlițe perete autocolante
- H Műanyag, fall kampó, öntapadós
- E Ganchos adhesivos para pared



No.	max (kg)	pcs	
74733	0.8	4	12/192

- PL Haczyki naścienne samoprzylepne
- GB Self-adhesive hanging hooks
- D Selbstklebende Wandhaken
- RUS Крючки настенные на липучках
- CZ Háčky nástěnné samolepící
- RO Cârlițe perete autocolante
- H Műanyag, fall kampó, öntapadós
- E Ganchos adhesivos para pared

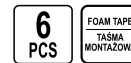

No.	max (kg)	pcs	
74734	0.4	6	16/192

PL Haczyki naścienne samoprzylepne
GB Self-adhesive hanging hooks
D Selbstklebende Wandhaken
RUS Крючки настенные на липучках

CZ Háčky nástěnné samolepící
RO Cărlige perete autocolante
H Műanyag, fall kampó, öntapadós
E Ganchos adhesivos para pared

3
PCS

FOAM TAPE
TASMA
MONTAZOWA

ABS



VOREL

No.	max (kg)	pcs	
74740	0.6	3	12/216

PL Haczyki naścienne samoprzylepne
GB Self-adhesive hanging hooks
D Selbstklebende Wandhaken
RUS Крючки настенные на липучках

CZ Háčky nástěnné samolepící
RO Cărlige perete autocolante
H Műanyag, fall kampó, öntapadós
E Ganchos adhesivos para pared

2
PCS

FOAM TAPE
TASMA
MONTAZOWA

ABS



VOREL

No.	max (kg)	pcs	
74741	1.5	2	12/216

PL Haczyki naścienne samoprzylepne
GB Self-adhesive hanging hooks
D Selbstklebende Wandhaken
RUS Крючки настенные на липучках

CZ Háčky nástěnné samolepící
RO Cărlige perete autocolante
H Műanyag, fall kampó, öntapadós
E Ganchos adhesivos para pared

2
PCS

FOAM TAPE
TASMA
MONTAZOWA

ABS



VOREL

No.	max (kg)	pcs	
74742	1.2	2	8/144

PL Haczyki naścienne samoprzylepne
GB Self-adhesive hanging hooks
D Selbstklebende Wandhaken
RUS Крючки настенные на липучках

CZ Háčky nástěnné samolepící
RO Cărlige perete autocolante
H Műanyag, fall kampó, öntapadós
E Ganchos adhesivos para pared

2
PCS

FOAM TAPE
TASMA
MONTAZOWA

ABS



VOREL

No.	max (kg)	pcs	
74743	1.0	2	12/144

PL Haczyki naścienne samoprzylepne
GB Self-adhesive hanging hooks
D Selbstklebende Wandhaken
RUS Крючки настенные на липучках

CZ Háčky nástěnné samolepící
RO Cărlige perete autocolante
E Ganchos adhesivos para pared

2
PCS

FOAM TAPE
TASMA
MONTAZOWA

ABS



VOREL

No.	max (kg)	pcs	
74744	1.0	2	8/144

PL Haczyki naścienne samoprzylepne
GB Self-adhesive hanging hooks
D Selbstklebende Wandhaken
RUS Крючки настенные на липучках
CZ Háčky nástěnné samolepící
RO Cărlige perete autocolante
H Műanyag, fall kampó, öntapadós
E Ganchos adhesivos para pared

2
PCS

FOAM TAPE
TASMA
MONTAZOWA

STEEL
STAL

ABS



VOREL

No.	max (kg)	pcs	
74750	1.0	2	16/192

PL Haczyki naścienne samoprzylepne
GB Self-adhesive hanging hooks
D Selbstklebende Wandhaken
RUS Крючки настенные на липучках
CZ Háčky nástěnné samolepící
RO Cărlige perete autocolante
H Műanyag, fall kampó, öntapadós
E Ganchos adhesivos para pared

3
PCS

FOAM TAPE
TASMA
MONTAZOWA

STEEL
STAL

ABS



VOREL

No.	max (kg)	pcs	
74751	0.8	3	12/192

PL Haczyki naścienne samoprzylepne
GB Self-adhesive hanging hooks
D Selbstklebende Wandhaken
RUS Крючки настенные на липучках
CZ Háčky nástěnné samolepící
RO Cărlige perete autocolante
H Műanyag, fall kampó, öntapadós
E Ganchos adhesivos para pared

3
PCS

STEEL
STAL

FOAM TAPE
TASMA
MONTAZOWA

ABS





VOREL

No.	max (kg)	pcs	
74752	1.2	3	12/216

PL Haczyki naścienne samoprzylepne
GB Self-adhesive hanging hooks
D Selbstklebende Wandhaken
RUS Крючки настенные на липучках
CZ Háčky nástěnné samolepicí
RO Cârlițe perete autocolante
H Műanyag, fall kampó, öntapadó
E Ganchos adhesivos para pared

5 PCS
 STEEL STAL
 FOAM TAPE TASMA MONTAZOWA
 ABS





VOREL

No.	max (kg)	pcs	
74753	0.4	5	16/288

PL Haczyki naścienne samoprzylepne
GB Self-adhesive hanging hooks
D Selbstklebende Wandhaken
RUS Крючки настенные на липучках
CZ Háčky nástěnné samolepicí
RO Cârlițe perete autocolante
H Műanyag, fall kampó, öntapadó
E Ganchos adhesivos para pared

FOAM TAPE TASMA MONTAZOWA
 STEEL STAL
 ABS





VOREL

No.	max (kg)	pcs	
74754	4.5	1	8/128

PL Haczyki naścienne szpilkowe
GB Wall hooks with pins
D Wandhaken, mit Nadeln
RUS Крючки настенные шпильковые
CZ Háčky do panelu Twenty
RO Cârlițe perete cu bolturi
H Műanyag, fall kampó, körmös
E Ganchos de alfiler para pared

8 PCS
 ABS





VOREL

No.	max (kg)	pcs	
74760	3.0	8	24/288

PL Haczyki naścienne szpilkowe
GB Wall hooks with pins
D Wandhaken, mit Nadeln
RUS Крючки настенные шпильковые
CZ Háčky do panelu Twenty
RO Cârlițe perete cu bolturi
H Műanyag, fall kampó, körmös
E Ganchos de alfiler para pared

5 PCS
 ABS





VOREL

No.	max (kg)	pcs	
74761	5.0	5	24/288

PL Haczyki naścienne szpilkowe
GB Wall hooks with pins
D Wandhaken, mit Nadeln
RUS Крючки настенные шпильковые
CZ Háčky do panelu Twenty
RO Cârlițe perete cu bolturi
H Műanyag, fall kampó, körmös
E Ganchos de alfiler para pared

3 PCS
 ABS





VOREL

No.	max (kg)	pcs	
74762	8.0	3	24/288

PL Haczyki naścienne na wkręt
GB Wall hooks with screws
D Wandhaken zum Anschrauben
RUS Крючки настенные на шурупах
CZ Háčky nástěnné na šroub
RO Cârlițe perete cu șurub
H Műanyag, fall kampó, csavaros
E Ganchos atomillados para pared

3 PCS
 ABS
 3x





VOREL

No.	max (kg)	pcs	
74765	5.0	3	16/256

PL Haczyki naścienne na wkręt
GB Wall hooks with screws
D Wandhaken zum Anschrauben
RUS Крючки настенные на шурупах
CZ Háčky nástěnné na šroub
RO Cârlițe perete cu șurub
H Műanyag, fall kampó, csavaros
E Ganchos atomillados para pared

3 PCS
 ABS
 3x





VOREL

No.	max (kg)	pcs	
74766	8.0	3	12/192

PL Ochroniacze na narożniki meblowe
GB Corner cushions
D Eckenschoner für Möbel
RUS Насадки на углы мебели
CZ Chráněče na rohy nábytku
RO Protecție colțuri mobilă
H Bűtor sarokvédő
E Protectores esquineros para muebles

4 PCS
 SOFT PLASTIC MIEKKE TWORZYWO
 DOUBLE SIDE TAPE TASMA DWUSTRONNA

VOREL

No.	pcs	
74771	4	16/288

PL Ochraniacze na narożniki meblowe
 GB Corner cushions
 D Eckenschoner für Möbel
 RUS Насадки на углы мебели

CZ Chrániče na rohy nábytku
 RO Protecție colțuri mobilă
 H Bűtor sarokvédő
 E Protectores esquineros para muebles

4 PCS SOFT PLASTIC, MIEKIE TWORZYWO
 DOUBLE SIDE TAPE, TASMA DWUSTRONNA



VOREL

No.	pcs	
74772	4	16/288

PL Ochraniacze na narożniki meblowe
 GB Corner cushions
 D Eckenschoner für Möbel
 RUS Насадки на углы мебели

CZ Chrániče na rohy nábytku
 RO Protecție colțuri mobilă
 H Bűtor sarokvédő
 E Protectores esquineros para muebles

4 PCS SOFT PLASTIC, MIEKIE TWORZYWO
 DOUBLE SIDE TAPE, TASMA DWUSTRONNA



VOREL

No.	pcs	
74773	4	12/144

PL Zabezpieczenie otwarcia drzwi meblowych
 GB Multi-purpose latches
 D Schutzsicherung gegen das Öffnen der Möbeltüren
 RUS Блокатор открывания дверей мебели

CZ Pojistka proti otevření nábytkových dveří
 RO Protecție deschidere ușă mobilă
 H Bűtorajtó-űtköző
 E Protectores para las portezuelas de muebles para prevenir su apertura

2 PCS ABS
 SOFT PLASTIC, MIEKIE TWORZYWO
 FOAM TAPE, TASMA MONTAZOWA



VOREL

No.	pcs	
74775	2	16/256

PL Zabezpieczenie otwarcia drzwi meblowych
 GB Multi-purpose latches
 D Schutzsicherung gegen das Öffnen der Möbeltüren
 RUS Блокатор открывания дверей мебели

CZ Pojistka proti otevření nábytkových dveří
 RO Protecție deschidere ușă mobilă
 H Bűtorajtó-űtköző
 E Protectores para las portezuelas de muebles para prevenir su apertura

2 PCS ABS
 SOFT PLASTIC, MIEKIE TWORZYWO
 FOAM TAPE, TASMA MONTAZOWA



VOREL

No.	pcs	
74776	2	12/216

PL Zabezpieczenie odkręcania kurków kuchennych
 GB Oven knob covers
 D Schutz gegen das Abdrehen von Küchenhähnen
 RUS Блокатор открывания кухонных кранов

CZ Pojistka proti otevření kuchyňských kohoutků
 RO Protecție desfacere manere bucătărie
 H Gázűzhely csapjának kinyitása ellen védő sapka
 E Protectores para las llaves de cocina para prevenir su apertura

2 PCS PLASTIC, PLASTIK



VOREL

No.	pcs	
74777	2	8/96

PL Hak
 GB Hook
 D Haken
 RUS Крюк

CZ Hak
 RO Cârlig
 H Kampó
 E Gancho



VOREL

No.	L (mm)	pcs packing	
78450	300	30	30/120

PL Hak
 GB Hook
 D Haken
 RUS Крюк

CZ Hak
 RO Cârlig
 H Kampó
 E Gancho



VOREL

No.	L (mm)	pcs packing	
78451	300	30	60/120

PL Zestaw wieszaków do drzwi
 GB Hook set
 D Hängevorrichtung für Türen, Salz
 RUS Набор вешалок на дверь

CZ Souprava věšáků na dveře
 RO Set umeraje pt. ușă
 H Akasztó készlet ajtóra
 E Juego de ganchos para la puerta

4 pcs STAINLESS STEEL, STAL NIEROZEWNA
3kg (max)



VOREL

No.	pcs	
74705	4	16

PL Wieszak gospodarczy
GB Tool holder
D Wirtschaftshängevorrichtung
RUS Хозяйственная вешалка

CZ Věšák pro domácnost
RO Umeraș de casă
H Háztartási akasztó
E Percha

510 mm 3kg (max) Al ABS



No.	L (mm)	
74701	510	20

PL Wieszak gospodarczy
GB Tool holder
D Wirtschaftshängevorrichtung
RUS Хозяйственная вешалка

CZ Věšák pro domácnost
RO Umeraș de casă
H Háztartási akasztó
E Percha

450 mm 3kg (max) ABS



No.	L (mm)	
74702	450	20

PL Wieszaki montowane do ściany
GB Storage hangers set
D Montagehaken für die Wand
RUS Крючки на стену

CZ Věši N CDP ROMA GRVěšny
RO Cărlige montate pe perete
H Falra szerelhető akasztó
E Ganchos para paredes

4 pcs

6mm

20kg (max)

PVC COATED POWŁOKA



No.	Ø (mm)	pcs	
74680	6	4	24/96

PL Wieszaki montowane do ściany
GB Storage hangers set
D Montagehaken für die Wand
RUS Крючки на стену

CZ Věši N CDP ROMA GRVěšny
RO Cărlige montate pe perete
H Falra szerelhető akasztó
E Ganchos para paredes

2 pcs

9mm

30kg (max)

PVC COATED POWŁOKA



No.	Ø (mm)	pcs	
74681	9	2	12/108

PL Wieszaki montowane do ściany
GB Storage hangers set
D Montagehaken für die Wand
RUS Крючки на стену

CZ Věši N CDP ROMA GRVěšny
RO Cărlige montate pe perete
H Falra szerelhető akasztó
E Ganchos para paredes

2 pcs

11mm

60kg (max)

PVC COATED POWŁOKA

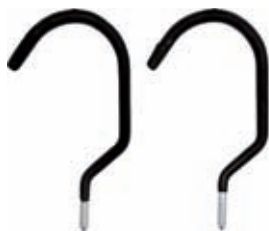

No.	Ø (mm)	pcs	
74685	11	2	12/48

PL Wieszaki montowane do ściany
GB Storage hangers set
D Montagehaken für die Wand
RUS Крючки на стену

CZ Věši N CDP ROMA GRVěšny
RO Cărlige montate pe perete
H Falra szerelhető akasztó
E Ganchos para paredes

5 pcs

6mm

15kg (max)

PVC COATED POWŁOKA



No.	Ø (mm)	pcs	
74688	6	5	24/96

PL Wieszaki montowane do ściany
GB Storage hangers set
D Montagehaken für die Wand
RUS Крючки на стену

CZ Věši N CDP ROMA GRVěšny
RO Cărlige montate pe perete
H Falra szerelhető akasztó
E Ganchos para paredes

8 pcs

6mm

15kg (max)

PVC COATED POWŁOKA



No.	Ø (mm)	pcs	
74689	6	8	12/48

PL Wieszak montowany do ściany
GB Storage hanger
D Montagehaken für die Wand
RUS Крючок на стену

CZ Věši N CDP ROMA GRVěšny
RO Cărlig montat pe perete
H Falra szerelhető akasztó
E Gancho para paredes

12mm

50kg (max)

PVC COATED POWŁOKA



No.	Ø (mm)	
74693	12	24/96

PL Wieszak montowany do ściany
GB Storage hanger
D Montagehaken für die Wand
RUS Крючок на стену

CZ Věšák NCDP RQMA GRVÁhny
RO Cărlig montat pe perete
H Falra szerelhető akasztó
E Gancho para paredes

∅ 8mm

30kg (max)



No.	∅ (mm)	
74695	8	12/144

PL Klipsy do przewodów
GB Cable clips
D Kabelspangen
RUS Скобы для кабеля

CZ Spony na kabely
RO Cleme pt. cabluri
H Kábelrögzítő
E Clips para cables

6 PCS



No.	pcs	
74970	6	25/300

PL Klipsy do przewodów
GB Cable clips
D Kabelspangen
RUS Скобы для кабеля

CZ Spony na kabely
RO Cleme pt. cabluri
H Kábelrögzítő
E Clips para cables

TPR



No.	size / rozmiar (mm)	pcs	
74973	25x25x10	6	25/300
74974	37x35x15	4	25/200
74975	60x50x25	2	25/200

PL Klipsy do przewodów
GB Cable clips
D Kabelspangen
RUS Скобы для кабеля

CZ Spony na kabely
RO Cleme pt. cabluri
H Kábelrögzítő
E Clips para cables

6 PCS

6 mm (max)

TPR



No.	pcs	
74977	6	25/300

PL Organizer do przewodów
GB Cable organizer
D Organizer für Leitungen
RUS Органайзер для проводов

CZ Organizér vodičů
RO Kábelrendező
H Organizator pt. cabluri
E Organizador para cables

10 PCS

PP



No.	pcs	
74980	10	25/300

PL Organizer gumowy „żółwik”
GB Rubber organizer „turtle”
D Gummiorganizer „Schildkröte”
RUS Резиновый органайзер для проводов «черепашка»

CZ *XP RYÉ RJDCI pUÁHONKA*
RO Organizator de cauciuc „broască testoasă”
H Gumi „teknősbéka” kábelrendező
E Organizador de caucho tipo „tortuga”

1m (max)

POWER OF CABLE
MOC MAX. NÁVINNÍTÉS
KÁBEL 1250 W

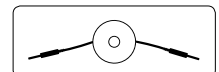

No.		
74983		25/300

PL Taśmy z rzepem do wiązania kabli
GB Cable holders
D Klett-Kabelbinder
RUS Фиксатор кабеля связи

CZ Na suchý zip kabelové svazky
RO Scali cablu cravată
H Tépőzáras kábelkötégető
E Brida con cierre de gancho y bucle

6 PCS

HOOK FASTENER RZEP



No.	pcs	
74985	6	25/300

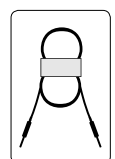

20

Health & safety products Artykuły BHP

Gloves
Rękawice

.....272-276



Goggles & shields
Okulary i osłony przeciwodpryskowe

.....276-277



Dust masks
Maski przeciwpyłowe

.....277



Welding goggles & masks
Okulary i maski spawalnicze

.....277-281



Knee pads
Nakolanniki

.....281-282



Hearing protectors
Nauszniki przeciwhałasowe

.....282



Safety helmets
Kaski ochronne

.....282



Protection sets
Zestawy ochronne

.....282



Breathalyzers
Alkomaty

.....282



Plastic capes
Peleryny foliowe

.....283



Rain boots
Kalosze

.....283



Working shoes
Buty robocze

.....284



Safety sandals
Sandaly robocze..... 284

Insoles
Wkładki do butów

.....284



Working clothes
Odzież robocza

.....284-285



Safety vests
Kamizelki ostrzegawcze..... 284

High visibility clothing
Ubrania ostrzegawcze..... 285

Waterproof jackets
Kurtki przeciwdeszczowe..... 285

Garden trousers
Spodnie ogrodnicze..... 285

Working clothes
Odzież robocza..... 285

Hand cleaning pastes
Pasty do mycia rąk

.....285



PL Rękawice robocze
GB Working gloves
D Arbeitshandschuh
RUS Перчатки

CZ Pracovní rukavice
RO Mănuși
H Védőkesztyű
E Guantes



No.



74000

12/120

PL Rękawice robocze
GB Working gloves
D Arbeitshandschuh
RUS Перчатки

CZ Pracovní rukavice
RO Mănuși
H Védőkesztyű
E Guantes



No.



74004

12/120

PL Rękawice robocze
GB Working gloves
D Arbeitshandschuh
RUS Перчатки

CZ Pracovní rukavice
RO Mănuși
H Védőkesztyű
E Guantes



No.



74094

240

PL Rękawice robocze
GB Working gloves
D Arbeitshandschuh
RUS Перчатки

CZ Pracovní rukavice
RO Mănuși
H Védőkesztyű
E Guantes



No.

pairs / pary



74100

1

12/300

74101

3

4/100

PL Rękawice robocze
GB Working gloves
D Arbeitshandschuh
RUS Перчатки

CZ Pracovní rukavice
RO Mănuși
H Védőkesztyű
E Guantes



No.

pairs / pary

packing



74102

1



10/240

74103

5



48

PL Rękawice robocze
GB Working gloves
D Arbeitshandschuh
RUS Перчатки

CZ Pracovní rukavice
RO Mănuși
H Védőkesztyű
E Guantes



No.

pairs / pary

packing



74104

1



10/240

74105

5



48

PL Rękawice robocze
GB Working gloves
D Arbeitshandschuh
RUS Перчатки

CZ Pracovní rukavice
RO Mănuși
H Védőkesztyű
E Guantes



No.

pairs / pary

packing



74106

1



10/240

74107

5



48

PL Rękawice robocze
GB Working gloves
D Arbeitshandschuh
RUS Перчатки

CZ Pracovní rukavice
RO Mănuși
H Védőkesztyű
E Guantes



No.



74108

240

PL Rękawice robocze
GB Working gloves
D Arbeitshandschuh
RUS Перчатки
CZ Pracovní rukavice
RO Mănuși
H Védőkesztyű
E Guantes



No.	pairs / pary	size / rozmiar	
74110	1	9	12/300
74111	3	9	4/100

PL Rękawice robocze
GB Working gloves
D Arbeitshandschuh
RUS Перчатки
CZ Pracovní rukavice
RO Mănuși
H Védőkesztyű
E Guantes



No.	size / rozmiar	
74125	8	12/300
74130	9	12/300
74131	10	12/300

PL Rękawice robocze
GB Working gloves
D Arbeitshandschuh
RUS Перчатки
CZ Pracovní rukavice
RO Mănuși
H Védőkesztyű
E Guantes



No.	size / rozmiar	
74126	8	12/300
74132	9	12/300
74133	10	12/300

PL Rękawice robocze
GB Working gloves
D Arbeitshandschuh
RUS Перчатки
CZ Pracovní rukavice
RO Mănuși
H Védőkesztyű
E Guantes



No.	size / rozmiar	
74127	8	12/300
74134	9	12/300
74135	10	12/300

PL Rękawice robocze
GB Working gloves
D Arbeitshandschuh
RUS Перчатки
CZ Pracovní rukavice
RO Mănuși
H Védőkesztyű
E Guantes



No.	size / rozmiar	
74128	8	12/300
74136	9	12/300
74137	10	12/300

PL Rękawice ogrodnicze
GB Gardening gloves
D Arbeitshandschuh
RUS Перчатки



8
SIZE / ROZMIAR



No.	size / rozmiar	
74117	8	50/1000

PL Rękawice ogrodnicze
GB Gardening gloves
D Arbeitshandschuh
RUS Перчатки

CZ Pracovní rukavice
RO Mănuși
H Védőkesztyű
E Guantes

8
SIZE / ROZMIAR



No.	size / rozmiar	
74121	8	50/1000



PL Rękawice ogrodnicze
GB Gardening gloves
D Arbeitshandschuh
RUS Перчатки

CZ Pracovní rukavice
RO Mănuși
H Védőkesztyű
E Guantes

8
SIZE / ROZMIAR



No.	size / rozmiar	
74123	8	50/1000



PL Rękawice ogrodnicze
GB Gardening gloves
D Arbeitshandschuh
RUS Перчатки

CZ Pracovní rukavice
RO Mănuși
H Védőkesztyű
E Guantes



No.	size / rozmiar	
74113	8	50/1000

PL Rękawice ogrodnicze
GB Gardening gloves
D Arbeitshandschuh
RUS Перчатки

CZ Pracovní rukavice
RO Mănuși
H Védőkesztyű
E Guantes



No.	size / rozmiar	
74115	8	50/1000

PL Rękawice robocze
GB Working gloves
D Arbeitshandschuh
RUS Перчатки
CZ Pracovní rukavice
RO Mănuși
H Védőkesztyű
E Guantes



No.	
74150	12/120

PL Rękawice robocze
GB Working gloves
D Arbeitshandschuh
RUS Перчатки
CZ Pracovní rukavice
RO Mănuși
H Védőkesztyű
E Guantes



No.	
74151	12/120

PL Rękawice robocze
GB Working gloves
D Arbeitshandschuh
RUS Перчатки
CZ Pracovní rukavice
RO Mănuși
H Védőkesztyű
E Guantes



No.	
74160	12/120

PL Rękawice robocze
GB Working gloves
D Arbeitshandschuh
RUS Перчатки
CZ Pracovní rukavice
RO Mănuși
H Védőkesztyű
E Guantes



No.	pairs / pary	packing	
74162	1		300
74164	10		30

PL Rękawice robocze
GB Working gloves
D Arbeitshandschuh
RUS Перчатки
CZ Pracovní rukavice
RO Mănuși
H Védőkesztyű
E Guantes



No.	pairs / pary	size / rozmiar	
74087	12	8	10
74088	12	9	10
74089	12	10	10

PL Rękawice robocze
GB Working gloves
D Arbeitshandschuh
RUS Перчатки
CZ Pracovní rukavice
RO Mănuși
H Védőkesztyű
E Guantes



No.	size / rozmiar	
74146	10	12/120

PL Rękawice robocze
GB Working gloves
D Arbeitshandschuh
RUS Перчатки
CZ Pracovní rukavice
RO Mănuși
H Védőkesztyű
E Guantes



12
PAIRS / PAR

10
SIZE / ROZMIAR

LATEX
POLYESTER
LATEKS
POLIESTER

2342 EN 388



No.	pairs / pary	size / rozmiar	
74145	12	10	10

PL Rękawice robocze
GB Working gloves
D Arbeitshandschuh
RUS Перчатки
CZ Pracovní rukavice
RO Mănuși
H Védőkesztyű
E Guantes



PE
PU



No.	size / rozmiar	
74079	9	12/120
74080	10	12/120

PL Rękawice robocze
GB Working gloves
D Arbeitshandschuh
RUS Перчатки
CZ Pracovní rukavice
RO Mănuși
H Védőkesztyű
E Guantes



12
PAIRS / PAR

PE
PU



No.	pairs / pary	size / rozmiar	
74077	12	9	10
74078	12	10	10

PL Rękawice robocze
GB Working gloves
D Arbeitshandschuh
RUS Перчатки
CZ Pracovní rukavice
RO Mănuși
H Védőkesztyű
E Guantes



12
PAIRS / PAR

POLYESTER
NITRILE
POLIESTER
NITRYL

4121 EN 388



No.	pairs / pary	size / rozmiar	
74152	12	8	10
74153	12	9	10
74154	12	10	10

PL Rękawice ochronne, ocieplane
GB Insulated gloves
D Isolierhandschuhe
RUS Утепленные перчатки

CZ Zimní rukavice
RO Mănuși izolate
H Szigetelt kesztyű
E Gants isolés



10
SIZE / ROZMIAR

LATEX
POLYESTER
LATEKS
POLIESTER

02X EN 511

2342 EN 388



No.	size / rozmiar	
74148	10	12/120

PL Rękawice robocze
GB Working gloves
D Arbeitshandschuh
RUS Перчатки
CZ Pracovní rukavice
RO Mănuși
H Védőkesztyű
E Guantes



10
SIZE / ROZMIAR

BAWELNA
NITRYLIT

4111 EN 388



No.	size / rozmiar	
74140	10	12/120

PL Rękawice robocze
GB Working gloves
D Arbeitshandschuh
RUS Перчатки

CZ Pracovní rukavice
RO Mănuși
H Védőkesztyű
E Guantes



12
PAIRS / PAR

COTTON
NITRILE
BAWELNA
NITRYL

4111 EN 388



No.	pairs / pary	size / rozmiar	
74084	12	8	10
74085	12	9	10
74086	12	10	10

PL Rękawice robocze
GB Working gloves
D Arbeitshandschuh
RUS Перчатки

CZ Pracovní rukavice
RO Mănuși
H Védőkesztyű
E Guantes



12
PAIRS / PAR

10
SIZE / ROZMIAR

COTTON
NITRILE
BAWELNA
NITRYL

4221 EN 388



No.	pairs / pary	size / rozmiar	
74142	12	10	10

PL Rękawice robocze
 GB Working gloves
 D Arbeitshandschuh
 RUS Перчатки
 CZ Pracovní rukavice
 RO Mănuși
 H Védőkesztyű
 E Guantes



No.	size / rozmiar	
74081	9	12/120
74082	10	12/120

PL Osłona twarzy przeciwdpryskowa
 GB Polycarbonate protection shield
 D Schutzmaske
 RUS Маска защитная

CZ Ochranná přilba /polyuhličtan/
 RO Masca protectie
 H Hegesztősisak /polivenglán/
 E Pantalla protectora antipedacitos



No.	
74459	25/50

PL Osłona twarzy przeciwdpryskowa
 GB Polycarbonate protection shield
 D Schutzmaske
 RUS Маска защитная
 CZ Ochranná přilba /polyuhličtan/
 RO Masca protectie
 H Hegesztősisak /polivenglán/
 E Pantalla protectora antipedacitos

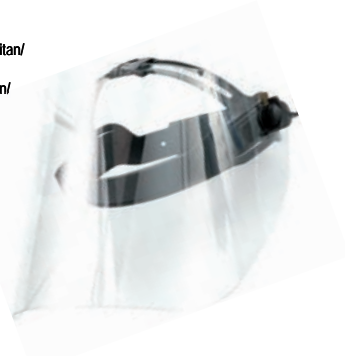

No.	
74460	20

PL Okulary ochronne
 GB Safety glasses
 D Schutzbrille
 RUS Очки защитные открытые

CZ Ochranné brýle
 RO Ochelari pt. protectie
 H Védőszemüveg
 E Gafas protectoras



No.	type	
74501	HF-111	12/240

PL Okulary ochronne
 GB Safety glasses
 D Schutzbrille
 RUS Очки защитные открытые



No.	type	
74502	HF-110	12/240

PL Okulary ochronne
 GB Safety glasses
 D Schutzbrille
 RUS Очки защитные открытые

CZ Ochranné brýle
 RO Ochelari pt. protectie
 H Védőszemüveg
 E Gafas protectoras



No.	type	
74503	DY-8525	15/150

PL Okulary ochronne
 GB Safety glasses
 D Schutzbrille
 RUS Очки защитные открытые



No.	type	
74504	DY-8526	15/150

PL Okulary ochronne
 GB Safety glasses
 D Schutzbrille
 RUS Очки защитные открытые

CZ Ochranné brýle
 RO Ochelari pt. protectie
 H Védőszemüveg
 E Gafas protectoras



No.	type	
74508	HF-103	10/120

PL Okulary ochronne
GB Safety glasses
D Schutzbrille
RUS Очки защитные открытые

CZ Ochranné brýle
RO Ochelari pt. protectie
H Védőszemüveg
E Gafas protectoras



No.	type	pcs. packing	box
74509	HF-105		10/100

PL Półmaski filtrujące jednorazowe
GB Disposable dust masks
D Atemschutzmaske
RUS Респиратор противопылевой одноразовый
CZ Protiprašná maska
RO Masca praf
H Eldobható porvédőmaszk
E Mascarilla desechable para protección contra polvo

5
PCS



No.	type	pcs. packing	box
74540	CDC3S	5	25/100

PL Półmaski filtrujące jednorazowe
GB Disposable dust masks
D Atemschutzmaske
RUS Респиратор противопылевой одноразовый
CZ Protiprašná maska
RO Masca praf
H Eldobható porvédőmaszk
E Mascarilla desechable para protección contra polvo

5
PCS



No.	type	pcs. packing	box
74541	CDC3V	5	15/60

PL Półmaski filtrujące jednorazowe
GB Disposable dust masks
D Atemschutzmaske
RUS Респиратор противопылевой одноразовый
CZ Protiprašná maska
RO Masca praf
H Eldobható porvédőmaszk
E Mascarilla desechable para protección contra polvo

5
PCS



No.	type	pcs. packing	box
74542	CFY3S	5	25/100

PL Półmaski filtrujące jednorazowe
GB Disposable dust masks
D Atemschutzmaske
RUS Респиратор противопылевой одноразовый
CZ Protiprašná maska
RO Masca praf
H Eldobható porvédőmaszk
E Mascarilla desechable para protección contra polvo

5
PCS



No.	type	pcs. packing	box
74543	CFY3V	5	15/60

PL Okulary spawalnicze
GB Welding goggles
D Schweisserbrille
RUS Очки газосварщика

CZ Brýle svářečské
RO Ochelari pt. sudura
H Hegesztőszemüveg
E Gafas para soldar



No.	type	pcs. packing	box
74400			25/100

PL Okulary spawalnicze
GB Welding goggles
D Schweisserbrille
RUS Очки газосварщика

CZ Brýle svářečské
RO Ochelari pt. sudura
H Hegesztőszemüveg
E Gafas para soldar



No.	type	pcs. packing	box
74410			5/100

PL Okulary spawalnicze
GB Welding goggles
D Schweisserbrille
RUS Очки газосварщика

CZ Brýle svářečské
RO Ochelari pt. sudura
H Hegesztőszemüveg
E Gafas para soldar



No.	type	pcs. packing	box
74411			10/100

PL Maska spawalnicza
 GB Welding mask
 D Schweissermaske
 RUS Щиток сварщика
 CZ Svářečská maska
 RO Mască de sudură
 H Hegesztőpajzs
 E Mascara de soldador



No.	type	
74440	TSM-3	30

PL Maska spawalnicza
 GB Welding mask
 D Schweissermaske
 RUS Щиток сварщика
 CZ Svářečská maska
 RO Mască de sudură
 H Hegesztőpajzs
 E Mascara de soldador



No.	type	
74442	TSMM	30

PL Maska spawalnicza
 GB Welding mask
 D Schweissermaske
 RUS Щиток сварщика
 CZ Svářečská maska
 RO Mască de sudură
 H Hegesztőpajzs
 E Mascara de soldador



No.	type	
74443	TSMP	20

PL Maska spawalnicza
 GB Welding mask
 D Schweissermaske
 RUS Щиток сварщика
 CZ Svářečská maska
 RO Mască de sudură
 H Hegesztőpajzs
 E Mascara de soldador



No.	type	
74450	TSD-3	20

PL Przyłbica spawalnicza z podglądem
 GB Welding mask
 D Schweissermaske
 RUS Щиток сварщика с подсмотром

CZ Svářečská přilba s nakoukáváním
 RO Mască de sudură cu geam
 H Hegesztősisak kitékintővel
 E Mascara de soldador con mirador



No.	type	
74447	PSMP	20

PL Przyłbica spawalnicza z podglądem
 GB Welding mask
 D Schweissermaske
 RUS Щиток сварщика с подсмотром

CZ Svářečská přilba s nakoukáváním
 RO Mască de sudură cu geam
 H Hegesztősisak kitékintővel
 E Mascara de soldador con mirador



No.	type	
74448	PS-3	10

PL Maska spawalnicza
 GB Welding mask
 D Schweissermaske
 RUS Щиток сварщика
 CZ Svářečská maska
 RO Mască de sudură
 H Hegesztőpajzs
 E Mascara de soldador



No.	
74441	20

PL Przyłbica spawalnicza
 GB Welding mask
 D Schweissermaske
 RUS Щиток сварщика

CZ Svářečská přilba s nakoukáváním
 RO Mască de sudură cu geam
 H Hegesztősisak kitékintővel
 E Mascara de soldador con mirador



No.	
74457	20

- PL Przyłbica spawalnicza samościemniająca
 GB Auto-darkening welding helmet
 D Schweissmaske, selbstverdunkelnd
 RUS Маска для сварки, самостоятельно затемняющаяся
 CZ Svářečská kukla samostmivací
 RO Mască de sudură auto-întunecare
 H Őnmagától sötétedő hegesztőpajzs
 E Casco auto-oscurecedor para soldadura



LIGHT STATE STAN JASNY 4	DARK STATE STAN CIEMNY 9-13	REACTION TIME CZAS REAKCJI 1/25000 s	2x3V CR2032 BATTERY WYKORZYSTANIE WŁAŚCIWOŚCI OPTYCZNE 1/2/1/2	-5°C/+55°C WORKING TEMPERATURE PRACY	
---------------------------------------	--	--	--	---	--



No.	
74435	6

- PL Przyłbica spawalnicza samościemniająca
 GB Auto-darkening welding helmet
 D Schweissmaske, selbstverdunkelnd
 RUS Маска для сварки, самостоятельно затемняющаяся
 CZ Svářečská kukla samostmivací
 RO Mască de sudură auto-întunecare
 H Őnmagától sötétedő hegesztőpajzs
 E Casco auto-oscurecedor para soldadura



LIGHT STATE STAN JASNY 4	DARK STATE STAN CIEMNY 9-13	REACTION TIME CZAS REAKCJI 1/25000 s	2x3V CR2032 BATTERY WYKORZYSTANIE WŁAŚCIWOŚCI OPTYCZNE 1/2/1/2	-5°C/+55°C WORKING TEMPERATURE PRACY	
---------------------------------------	--	--	--	---	--



No.	
74436	6

- PL Przyłbica spawalnicza samościemniająca
 GB Auto-darkening welding helmet
 D Schweissmaske, selbstverdunkelnd
 RUS Маска для сварки, самостоятельно затемняющаяся
 CZ Svářečská kukla samostmivací
 RO Mască de sudură auto-întunecare
 H Őnmagától sötétedő hegesztőpajzs
 E Casco auto-oscurecedor para soldadura



LIGHT STATE STAN JASNY 4	DARK STATE STAN CIEMNY 9-13	REACTION TIME CZAS REAKCJI 1/15000 s	0.25 - 0.85 s BRIGHTENING TIME CZAS ROZJAŚNIENIA	0.25 - 0.8 ms DARKENING TIME CZAS ZACIEMNIENIA	VIEWING AREA POLE WIDZENIA 92x42 mm	2 ARC SENSOR LICZKA CZUJNIKOWA ŁUKU	GRINDING WELDING SZLIFOWANIE SPAWANIE	SENSITIVITY CZUŁOŚĆ	DELAY OPÓŹNIENIE	SOLAR CELL OGNIWO SŁONECZNE	AUTOMATIC POWER ON/OFF AUTOMATYCZNE WŁĄCZANIE I WYCIĄGANIE	-5°C/+55°C WORKING TEMPERATURE TEMPERATURA PRACY	UV / IR	3 POINT HEADGEAR WIĘZBA 3 PUNKTOWA	OPTICAL CHARACTERISTIC WŁAŚCIWOŚCI OPTYCZNE 1/2/1/2	
---------------------------------------	--	--	--	--	--	--	--	------------------------	---------------------	--------------------------------------	---	--	---------	---	---	--



No.	
74480	6

- PL Przyłbica spawalnicza samościemniająca
 GB Auto-darkening welding helmet
 D Schweissmaske, selbstverdunkelnd
 RUS Маска для сварки, самостоятельно затемняющаяся
 CZ Svářečská kukla samostmivací
 RO Mască de sudură auto-întunecare
 H Őnmagától sötétedő hegesztőpajzs
 E Casco auto-oscurecedor para soldadura



LIGHT STATE STAN JASNY 4	DARK STATE STAN CIEMNY 9-13	REACTION TIME CZAS REAKCJI 1/25000 s	0.1 - 1.0 s BRIGHTENING TIME CZAS ROZJAŚNIENIA	0.3 - 0.9 ms DARKENING TIME CZAS ZACIEMNIENIA	VIEWING AREA POLE WIDZENIA 98x45 mm	2 ARC SENSOR LICZKA CZUJNIKOWA ŁUKU	GRINDING WELDING SZLIFOWANIE SPAWANIE	SENSITIVITY CZUŁOŚĆ	DELAY OPÓŹNIENIE	SOLAR CELL OGNIWO SŁONECZNE	AUTOMATIC POWER ON/OFF AUTOMATYCZNE WŁĄCZANIE I WYCIĄGANIE	-5°C/+55°C WORKING TEMPERATURE TEMPERATURA PRACY	UV / IR	3 POINT HEADGEAR WIĘZBA 3 PUNKTOWA	2x3V CR2032 BATTERY WYKORZYSTANIE WŁAŚCIWOŚCI OPTYCZNE 1/2/1/3	LOW BATTERY ALARM WSKAZNIK WYCZERPIANIA BATERII	FILTER TEST TEST FILTRA	
---------------------------------------	--	--	--	---	--	--	--	------------------------	---------------------	--------------------------------------	---	--	---------	---	--	---	----------------------------	--



No.	
74481	6

- PL Przyłbica spawalnicza samościemniająca
 GB Auto-darkening welding helmet
 D Schweissmaske, selbstverdunkelnd
 RUS Маска для сварки, самостоятельно затемняющаяся
 CZ Svářečská kukla samostmivací
 RO Mască de sudură auto-întunecare
 H Őnmagától sötétedő hegesztőpajzs
 E Casco auto-oscurecedor para soldadura



LIGHT STATE STAN JASNY 4	DARK STATE STAN CIEMNY 9-13	REACTION TIME CZAS REAKCJI 1/25000 s	0.1 - 1.0 s BRIGHTENING TIME CZAS ROZJAŚNIENIA	0.4 - 1.4 ms DARKENING TIME CZAS ZACIEMNIENIA	VIEWING AREA POLE WIDZENIA 100x50 mm	2 ARC SENSOR LICZKA CZUJNIKOWA ŁUKU	GRINDING WELDING SZLIFOWANIE SPAWANIE	SENSITIVITY CZUŁOŚĆ	DELAY OPÓŹNIENIE	SOLAR CELL OGNIWO SŁONECZNE	AUTOMATIC POWER ON/OFF AUTOMATYCZNE WŁĄCZANIE I WYCIĄGANIE	-5°C/+55°C WORKING TEMPERATURE TEMPERATURA PRACY	UV / IR	3 POINT HEADGEAR WIĘZBA 3 PUNKTOWA	2x3V CR2032 BATTERY WYKORZYSTANIE WŁAŚCIWOŚCI OPTYCZNE 1/2/1/2	LOW BATTERY ALARM WSKAZNIK WYCZERPIANIA BATERII	FILTER TEST TEST FILTRA	
---------------------------------------	--	--	--	---	---	--	--	------------------------	---------------------	--------------------------------------	---	--	---------	---	--	---	----------------------------	--



No.	
74482	6

- PL Przyłbica spawalnicza
 GB Welding helmet
 D Schweissermaske
 RUS Щиток сварщика
- CZ Svářečská maska
 RO Mască de sudură
 H Hegesztőpajzs
 E Mascara de soldador



108x50 mm
WELDING FILTER FILTR SPAWALNICZY 10



No.	
74449	12

- PL Przyłbica z osłoną wymienną
- GB Face shield with PC visor
- D Schweißerschutzhelm mit austauschbarer Abdeckung
- RUS Шлем с заменяемой защитой
- CZ Štit s vyměnitelným krytem
- RO Vizieră cu protecție schimbabilă
- H Arcvédő cserélhető pajzs
- E Antifaz con protección reemplazable

VISOR
OSŁONA
395x200
mm



No.		
74461		40

- PL Osłona wymienna z tworzywa
- GB PC visor
- D Austauschbare Abdeckung aus Kunststoff
- RUS Заменяемая защита из пластмассы
- CZ Vyměnitelný kryt z plastu
- RO Protecție schimbabilă din plastic
- H Cserélhető, műanyag pajzs
- E Protección reemplazable de materia plástica



No.	size (mm)	
74463	305x200	200
74464	395x200	150

- PL Osłona filtra
- GB Filter shield
- D Filterabdeckung
- RUS Кожух фильтра
- CZ Ochrana filtru
- RO Aparatoare de filtru
- H Szűrővédőburkolat
- E Protección de filtro



No.	mm	type	
74451	50x100	E-0	150

- PL Osłona filtra
- GB Filter protection
- D Filtereinsatz
- RUS Кожух фильтра
- CZ Ochranná folie filtru
- RO Carcasă filtru
- H Szűrő-védőburkolat
- E Protección del filtro

POLYCARBONATE
POLIWEGLAN



No.	mm	type	for / dla	
74467	345x190	OTS	74459	100

- PL Przyłbica z osłoną wymienną i nausznikami przeciwhałasowymi
- GB Face shield with steel mesh and ear muff
- D Schweißerschutzhelm mit austauschbarer Abdeckung und Ohrenschützer gegen Lärm
- RUS Шлем с заменяемой защитой и наушниками против шума
- CZ Štit s vyměnitelným krytem a chrániči proti hluku
- RO Vizieră cu protecție schimbabilă și căști de protecție antizgomot
- H Arcvédő cserélhető pajzs és fülvédő kagylóval
- E Antifaz con protección reemplazable y protectores de oídos

MESH
OSŁONA
395x200
mm



No.		
74462		40

- PL Filtr spawalniczy
- GB Welding filter
- D Vorsatzglas
- RUS Фильтр для сварки
- CZ Filtr svářečský
- RO Filtru pt. sudării
- H Hegesztőszűrő
- E Pantalla de filtro de soldador

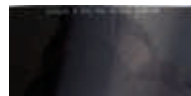

No.	mm	type	
74452	50x100	E-8	100
74453	50x100	E-9	100
74454	50x100	E-10	100
74455	50x100	E-11	100
74456	50x100	E-12	100

- PL Osłona filtra
- GB Filter protection
- D Filtereinsatz
- RUS Кожух фильтра
- CZ Ochranná folie filtru
- RO Carcasă filtru
- H Szűrő-védőburkolat
- E Protección del filtro

POLYCARBONATE
POLIWEGLAN



No.	mm	type	for / dla	
74466	350x200	OT 1-N	74460	10/100

PL Oslona filtra przybicia samościemniającej
 GB Self-dimming helmet filter protection
 D Filtereinsatz eines selbstabdunkelnden Schutzhelmes
 RUS Кожух фильтра самозатемняющегося щитка
 CZ Ochranná folie filtru samostmívající kukly
 RO Carcasă filtru vizieră hellomată
 H Hegesztőpajzs szűrő, önsötétedő
 E Protección del filtro de visera autooscurecedora



No.	mm	pcs	
74439	90x110	5	20

PL Nakolanniki CZ Chrániče kolen
 GB Knee pads RO Genunchiere
 D Knieschützer H Térdvédő
 RUS Наколенники E Rodilleras



No.	
74600	50

PL Nakolanniki CZ Chrániče kolen
 GB Knee pads RO Genunchiere
 D Knieschützer H Térdvédő
 RUS Наколенники E Rodilleras



No.	
74610	20

PL Nakolanniki CZ Chrániče kolen
 GB Knee pads RO Genunchiere
 D Knieschützer H Térdvédő
 RUS Наколенники E Rodilleras



No.	
74620	12/48

PL Nakolanniki CZ Chrániče kolen
 GB Knee pads RO Genunchiere
 D Knieschützer H Térdvédő
 RUS Наколенники E Rodilleras



No.	
74622	50

PL Nakolanniki CZ Chrániče kolen
 GB Knee pads RO Genunchiere
 D Knieschützer H Térdvédő
 RUS Наколенники E Rodilleras



No.	
74624	12/24

PL Nakolanniki CZ Chrániče kolen
 GB Knee pads RO Genunchiere
 D Knieschützer H Térdvédő
 RUS Наколенники E Rodilleras



No.	
74601	24

PL Nakolanniki CZ Chrániče kolen
 GB Knee pads RO Genunchiere
 D Knieschützer H Térdvédő
 RUS Наколенники E Rodilleras



No.	
74602	6/36

PL Nakolanniki CZ Chráníče kolen
 GB Knee pads RO Genunchiere
 D Knieschützer H Térdvédő
 RUS Наколенники E Rodilleras



No.

74623



12/24

PL Nauszniki przeciwhałasowe CZ Chráníče sluchu
 GB Ear muff RO Antifoane
 D Gehörschutz H Fülvédőt
 RUS Средства защиты слуха E Protectores de la vista

SNR
24dB



No.

74580



60

PL Nauszniki przeciwhałasowe CZ Chráníče sluchu
 GB Ear muff RO Antifoane
 D Gehörschutz H Fülvédőt
 RUS Средства защиты слуха E Protectores de la vista



No.

74581



10/60

PL Kask ochronny GB Safety helmet
 D Schutzhelm
 RUS Каска защитная
 CZ Ochranná prilba
 RO Cască de protecție
 H Védősisak
 E Casco de protección

ABS



No.

colour / kolor



74190



40

74191



40

74192



40

74193



40

74194



40

74195



40

PL Zestaw ochronny, nauszniki, gogle, półmaska filtrująca
 GB Safety tools set: ear muff, goggles, dust mask
 D Schutzausrüstungssatz: Ohrenschützer, Schutzbrille, Halbmaske mit Filter
 RUS Набор защитный: наушники, очки, респиратор фильтровый
 CZ Sada ochranných prostriedků: chráníče sluchu, brýle, maska proti prachu
 RO Set de protecție: protecție pt. urechi, ochelari de protecție, semimască filtrare
 H Munkavédelmi szett: fülvédő, védőszemüvel, szűrős félálarc
 E Juego de protección: orejeras, gafas protectoras, semimáscara con filtro



No.

74585



40

PL Kask ochronny drwala GB Lumberjack helmet
 D Schutzhelm für Holzfäller
 RUS Защитный шлем лесоруба
 CZ Ochranná prilba pro dřevorubce
 RO Cască de protecție pt. tăietor de lemne
 H Favágó védősisak
 E Casco de leñador

SNR
23 dB

ABS



No.

74201



8

PL Alkomat jednorazowy CZ Alkohol tester
 GB Disposable breathalyzer RO Alcoolmetru
 D Alkoholltester H Alkoholszonda
 RUS Алкотестер E Alcoholimetro



No.

83710



25

- PL Płaszcz foliowy przeciwdeszczowy
 GB Plastic raincoat
 D Folienregenmantel
 RUS Плащ-дождевик полиэтиленовый
 CZ Pláštěnka
 RO Manta de ploaie din plastic
 H Műanyag esőkabát
 E Impermeable de plástico



No.

74644



50/300

- PL Peleryna foliowa dziecięca
 GB Kid plastic cape
 D Folienumhang für Kinder
 RUS Плащ-дождевик полиэтиленовый детский
 CZ Dětská pláštěnka
 RO Pelerina de ploaie pt. copil
 H Gyermek műanyag pelerin
 E Capa de plástico para niños



No.

74640



50/400

- PL Kalosze damskie
 GB Women's rain boots
 D Damen - Gummistiefel
 RUS Галоши женские



No.

size / rozmiar

model



72831	36	LUNA	7
72832	37	LUNA	7
72833	38	LUNA	7
72834	39	LUNA	5
72835	40	LUNA	5
72836	41	LUNA	5

- PL Kalosze męskie
 GB Men's rain boots
 D Herren - Gummistiefel
 RUS Галоши мужские

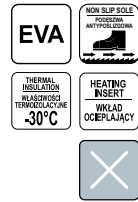

No.

size / rozmiar

model



72840	41	PREDATOR XL	6
72841	42	PREDATOR XL	6
72842	43	PREDATOR XL	6
72843	44	PREDATOR XL	6
72844	45	PREDATOR XL	6
72845	46	PREDATOR XL	6
72846	47	PREDATOR XL	6

- PL Kalosze damskie
 GB Women's rain boots
 D Damen - Gummistiefel
 RUS Галоши женские



No.

size / rozmiar

model



72850	36	RAINNY BLACK	10
72851	37	RAINNY BLACK	10
72852	38	RAINNY BLACK	10
72853	39	RAINNY BLACK	10
72854	40	RAINNY BLACK	10

- PL Kalosze męskie
 GB Men's rain boots
 D Herren - Gummistiefel
 RUS Галоши мужские



No.

size / rozmiar

model



72858	41	GRAND BLACK	8
72859	42	GRAND BLACK	8
72860	43	GRAND BLACK	8
72861	44	GRAND BLACK	8
72862	45	GRAND BLACK	6
72863	46	GRAND BLACK	6
72864	47	GRAND BLACK	6

PL Sandały robocze
GB Safety sandals
D Arbeitshalbschuhe
RUS Полуботинки рабочие

CZ Pracovní polobotky
RO Papuc de lucru
H Munkavédelmi félcipő
E Zapato de trabajo



No.	size / rozmiar	model	
72801	39	SALTA	10
72802	40	SALTA	10
72803	41	SALTA	10
72804	42	SALTA	10
72805	43	SALTA	10
72806	44	SALTA	10
72807	45	SALTA	10
72808	46	SALTA	10
72809	47	SALTA	10

PL Sandały robocze
GB Safety sandals
D Arbeitshalbschuhe
RUS Полуботинки рабочие

CZ Pracovní polobotky
RO Papuc de lucru
H Munkavédelmi félcipő
E Zapato de trabajo



No.	size / rozmiar	model	
72821	39	SERRA	10
72822	40	SERRA	10
72823	41	SERRA	10
72824	42	SERRA	10
72825	43	SERRA	10
72826	44	SERRA	10
72827	45	SERRA	10
72828	46	SERRA	10
72829	47	SERRA	10

PL Antybakteryjna wkładka do butów
GB Antibacterial insole
D Antibakterielle Einlage für Schuhe
RUS Антибактериальная стелька

CZ ŠKEDNÍK VYBĚR
RO Tălpiци antibacterieni
H Antibakteriális cipőbetét
E Planilla antibacterial



No.	size / rozmiar	thickness / grubość (mm)	
72683	39 / 40	3.2	50
72684	41 / 42	3.2	50
72685	43 / 44	3.2	50
72686	45 / 46	3.2	50

PL Kamizelka ostrzegawcza
GB Reflective vest
D Warnweste
RUS Жилет безопасности

CZ 9eVMDQ YHM
RO Vestă de avertizare
H Fényvisszaverő mellény
E Chaleco reflectante

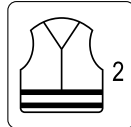
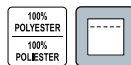

No.	size / rozmiar	model	
74660	L	VEST-O	100
74661	XL	VEST-O	100
74662	XXL	VEST-O	100
74663	XXXL	VEST-O	100

PL Kamizelka ostrzegawcza
GB Reflective vest
D Warnweste
RUS Жилет безопасности

CZ 9eVMDQ YHM
RO Vestă de avertizare
H Fényvisszaverő mellény
E Chaleco reflectante

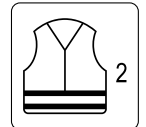
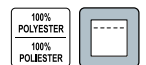

No.	size / rozmiar	model	
74664	L	VEST-G	100
74665	XL	VEST-G	100
74666	XXL	VEST-G	100
74667	XXXL	VEST-G	100

- PL Ubranie ostrzegawcze
 GB High visibility clothing
 D Warnkleidung
 RUS Предупреждающая одежда
 CZ 9eWMDA0C RC0v
 RO Haine reflectorizante
 H Fényviszaverő ruha
 E Mono de trabajo de advertencia



No.	size / rozmiar	model	
72905	S	CRESTON	20
72906	M	CRESTON	20
72907	L	CRESTON	20
72908	XL	CRESTON	20
72909	XXL	CRESTON	20

- PL Kurтка przeciwdeszczowa
 GB Waterproof jacket
 D Regenjacke
 RUS Куртка-дождевик
 CZ Bunda do deszczu
 RO Giacă impermeabilă
 H Vízhatlan dzseki
 E Chaqueta impermeable



No.	size / rozmiar	
74635	M	24
74636	L	24
74637	XL	24
74638	XXL	24
74639	XXXL	24

- PL Spodnie ogrodnicze
 GB Garden trousers
 D Gartenhosen
 RUS Брюки садовые
 CZ Zahradnické kalhoty
 RO Pantaloni pt. grădinarit
 H Kertész nadrág
 E Pantalón de jardinería

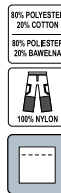

No.	size / rozmiar	
72900	S	10
72901	M	10
72902	L	10
72903	XL	10

- PL Ubranie robocze
 GB Working clothes
 D Arbeitskleidung
 RUS Рабочая одежда
 CZ Pracovní oděv
 RO Haine de lucru
 H Munkaruha
 E Ropa de trabajo



No.	size / rozmiar	model	
74220	S	EBRO	24
74221	M	EBRO	24
74222	L	EBRO	24
74223	XL	EBRO	24
74224	XXL	EBRO	24

- PL Pasta BHP
 GB Heavy-duty hand cleaning paste
 D Paste BHP
 RUS Чистящая паста
 CZ Pasta BOZP
 RO Pastă pt. protecția și igiena muncii
 H Munkavédelmi paszta
 E Pasta para limpiar las manos para aplicaciones industriales



No.	ml	
86780	500	16

- PL Pasta do mycia rąk
 GB Hand cleaning paste
 D Paste zum Händewaschen
 RUS Паста для мытья рук
 CZ Pasta na mytí rukou
 RO Pastă pt. spălarea mâinilor
 H Kézmosó paszta
 E Pasta para limpiar las manos



No.	l	
86785	0.5	18

21

Electric products
Artykuły elektryczne

Extension cords & cable reels
Przedłużacze listwowe
i bębnowe

288-289

Extension cords French type

Przedłużacze elektryczne z uziemieniem..... 288

Extension cords

Przedłużacze elektryczne bez uziemienia..... 288

Christmas tree extension cables

Przedłużacze choinkowe..... 289

Cable reels French type

Przedłużacze bębnowe z uziemieniem..... 289

Adaptors
Rozgałęźniki

290

Led bulbs
Żarówki LED

290-291

Lamps
Lampy

291-294

Halogen projectors

Lampy halogenowe..... 291

Halogen bulbs

Żarówki do lamp halogenowych..... 292

Workshop neon lamps

Warsztatowe lampy neonowe..... 292

Workshop LED lamps

Warsztatowe lampy diodowe..... 293

LED flashlights

Latarki diodowe..... 294

PL Przedłużacz elektryczny z uziemieniem
 GB Cord extension with earthing
 D Tischsteckdose bolzenanschl
 RUS Удлинитель электрический с заземлением

CZ (ONMENE SURCIBARÝDĚ
 RO Prelungitor electric
 H Elektromos hosszabbító
 E Extensión electr.



No.	L (m)	☺	type	📦
72500	1.5	3	E	12/48
72501	1.5	4	E	12/48
72504	3.0	3	E	12/48
72505	3.0	4	E	12/48
72506	3.0	5	E	12/48
72508	5.0	3	E	12/48
72509	5.0	4	E	12/48
72510	5.0	5	E	12/48

PL Przedłużacz elektryczny bez uziemienia
 GB Cord extension without earthing
 D Tischsteckdose ohne nullleitung
 RUS Удлинитель электрический без заземления
 CZ (ONMENE SURCIBARÝDĚ
 RO Prelungitor electric
 H Elektromos hosszabbító
 E Extensión electr.



No.	L (m)	☺	type	📦
72484	1.5	3	C	12/48
72486	1.5	4	C	12/48
72489	3.0	3	C	12/48
72490	3.0	4	C	12/48
72493	5.0	3	C	12/48
72494	5.0	4	C	12/48

PL Przedłużacz elektryczny z uziemieniem
 GB Cord extension with earthing
 D Tischsteckdose bolzenanschl
 RUS Удлинитель электрический с заземлением

CZ (ONMENE SURCIBARÝDĚ
 RO Prelungitor electric
 H Elektromos hosszabbító
 E Extensión electr.

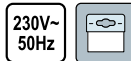

No.	L (m)	☺	type	📦
72625	1.5	3	E	12/48
72626	3.0	3	E	12/48
72627	5.0	3	E	12/48
72630	1.5	4	E	12/48
72631	3.0	4	E	12/48
72632	5.0	4	E	12/48

PL Przedłużacz elektryczny z uziemieniem
 GB Cord extension with earthing
 D Tischsteckdose bolzenanschl
 RUS Удлинитель электрический с заземлением

CZ (ONMENE SURCIBARÝDĚ
 RO Prelungitor electric
 H Elektromos hosszabbító
 E Extensión electr.

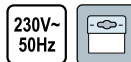

No.	L (m)	☺	type	📦
72615	1.5	3	E	12/48
72616	3.0	3	E	12/48
72617	5.0	3	E	12/48
72620	1.5	4	E	12/48
72621	3.0	4	E	12/48
72622	5.0	4	E	12/48

PL Przedłużacz elektryczny z wyłącznikiem
 GB Cord extension with switch
 D Tischsteckdose
 RUS Удлинитель электрический с выключателем

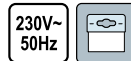

CZ (ONMENE SURCIBARÝDĚ
 RO Prelungitor electric
 H Elektromos hosszabbító
 E Extensión para arbol de navidad verde



No.	L (m)	☺	type	📦
72524	1.5	3	E	12/48
72525	1.5	4	E	12/48
72526	1.5	5	E	12/48
72527	1.5	6	E	12/48
72528	3.0	3	E	12/48
72529	3.0	4	E	12/48
72530	3.0	5	E	12/48
72531	3.0	6	E	12/48
72532	5.0	3	E	12/48
72533	5.0	4	E	12/48
72534	5.0	5	E	12/48
72535	5.0	6	E	12/48

PL Przedłużacz elektryczny z uziemieniem
 GB Cord extension with earthing
 D Tischsteckdose bolzenanschl
 RUS Удлинитель электрический с заземлением

CZ (ONMENE SURCIBARÝDĚ
 RO Prelungitor electric
 H Elektromos hosszabbító
 E Extensión electr.

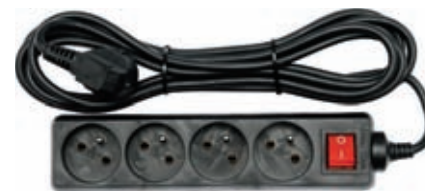
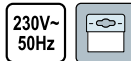

PL Przedłużacz elektryczny
GB Extension cord
D Verlängerungsschnur
RUS Удлинитель электрический

CZ 3 ÚROZÁRYDI NDEHJ DKUDCQ
RO Prelungitor electric
H Elektromos hosszabbító
E Extensión electr.

230V~
50Hz

16A

2x 5 V
USB 1 A



No.	L (m)	☺	type	📦
72750	1.5	3	E / E&F	40
72755	3.0	5	E / E&F	30

PL Przedłużacz
GB Garden extension cable
D Gartenverlängerungskabel
RUS Электроудлинитель

CZ 3 ÚROZÁRYDI NDEHJ DKUDCQ
RO Prelungitor electric
H Kerti hosszabbító
E Cable de extensión para jardín

230V~
50Hz



No.	L (m)	📦
82671	10	10
82673	20	10
82675	30	5
82677	40	5

PL Przedłużacz
GB Garden extension cable
D Gartenverlängerungskabel
RUS Электроудлинитель

CZ 3 ÚROZÁRYDI NDEHJ DKUDCQ
RO Prelungitor electric
H Kerti hosszabbító
E Cable de extensión para jardín

230V~
50Hz

10m



No.	L (m)	📦
72455	10	10

PL Przedłużacz zielony
GB Christmas tree extension cable
D Christbaum Verlängerungskabel
RUS Удлинитель

CZ 3 ÚROZÁRYDI NDEHJ DKUDCQ
RO Prelungitor electric
H Elektromos hosszabbító
E Extensión para árbol de navidad verde

230V~
50Hz



No.	L (m)	📦
72451	3	10
72452	5	10

PL Przedłużacz zwijany
GB Cable reel
D Kabeltrommel bolzenanschl
RUS Удлинитель электрический
CZ 3 ÚROZÁRYDI NDEHJ DKUDCQ
RO Prelungitor pe tambur
H Kábeldob
E Extensión electr.



PVC



No.	L (m)	☺	type	📦
72570	15	4	E	4
72572	25	4	E	4
72573	30	4	E	4

PL Przedłużacz bębnowy
GB Cable reel
D Kabeltrommel
RUS Удлинитель на катушке
CZ 3 ÚROZÁRYDI NDEHJ DKUDCQ
RO Prelungitor pe tambur
H Kábeldob
E Cable de prolongación de tambor



230V~
50Hz



No.	L (m)	☺	type	📦
82682	25	4	E	2
82684	40	4	E	2
82685	50	4	E	2

PL Przedłużacz bębnowy, silowy
GB Cable reel
D Kabeltrommel
RUS Удлинитель силовой на катушке
CZ 3 ÚROZÁRYDI NDEHJ DKUDCQ
RO Prelungitor pe tambur
H Kábeldob
E Cable de prolongación de tambor



230V~
50Hz

400V~
50Hz



No.	L (m)	A	📦
82687	20	16	1

PL Przedłużacz silowy
GB Force extension cord
D Verlängerungsleitung für Kraftstrom
RUS Силовой удлинитель

CZ 3 ÚROZÁRYDI NDEHJ DKUDCQ
RO Prelungitor electric
H 3-fázisú hosszabbító
E Extensión de fuerza

230V~
50Hz

400V~
50Hz



No.	L (m)	A	📦
72600	20	16	1

PL Rozgaleźnik
GB Adapter
D Abzweigung
RUS Разветвитель

CZ Rozdvojka
RO Splitter
H Oszło
E Enchufe múltiple

230V~
50Hz

16A





No.		type	
72404	2	E	100

PL Rozgaleźnik
GB Adapter
D Abzweigung
RUS Разветвитель

CZ Rozdvojka
RO Splitter
H Oszło
E Enchufe múltiple

230V~
50Hz

16A



No.		type	
72407	3	E	100

PL Rozgaleźnik
GB Adapter
D Abzweigung
RUS Разветвитель

CZ Rozdvojka
RO Splitter
H Oszło
E Enchufe múltiple

230V~
50Hz

6A



No.		type	
72400	2	C&E&F	200
72401	3	C&E&F	100
72402	4	C&E&F	100

PL Żarówka LED
GB LED light bulb
D LED- Glühlampe
RUS Светодиодная лампочка

CZ /(' ai URMD
RO Bec LED
H LED égő
E Bombilla LED

LED

E14
230V 50Hz

3000 K
CRI > 80

WHITE WARM
BIAŁY
CIEPLY



No.	W	lm	replacement / odpowiednik (W)	
83801	3	210	25	50/100
83803	5	320	35	50/100
83805	7	420	40	50/100

PL Żarówka LED
GB LED light bulb
D LED- Glühlampe
RUS Светодиодная лампочка

CZ /(' ai URMD
RO Bec LED
H LED égő
E Bombilla LED

LED

E27
230V 50Hz

3000 K
CRI > 80

WHITE WARM
BIAŁY
CIEPLY



No.	W	lm	replacement / odpowiednik (W)	
83802	3	210	25	50/100
83804	5	320	35	50/100
83806	7	420	40	50/100

PL Żarówka LED
GB LED light bulb
D LED- Glühlampe
RUS Светодиодная лампочка

CZ /(' ai URMD
RO Bec LED
H LED égő
E Bombilla LED

LED

E27
230V 50Hz

3000 K
CRI > 80

WHITE WARM
BIAŁY
CIEPLY



No.	W	lm	replacement / odpowiednik (W)	
83811	7	580	40	50/100
83812	10	800	60	50/100
83813	12	900	75	50/100

PL Żarówka LED
GB LED light bulb
D LED- Glühlampe
RUS Светодиодная лампочка

CZ /(' ai URMD
RO Bec LED
H LED égő
E Bombilla LED

LED

E14
230V 50Hz

3000 K
CRI > 80

WHITE WARM
BIAŁY
CIEPLY



No.	W	lm	replacement / odpowiednik (W)	
83821	3	210	20	50/100
83822	5	320	30	50/100
83823	7	420	40	50/100

PL Żarówka LED
GB LED light bulb
D LED- Glühlampe
RUS Светодиодная лампочка

CZ /(' ai URMD
RO Bec LED
H LED égő
E Bombilla LED

LED

E14
230V 50Hz

3000 K
CRI > 80

WHITE WARM
BIAŁY
CIEPLY



No.	W	lm	replacement / odpowiednik (W)	
83831	5	340	35	50/200

PL Żarówka LED CZ /(' ái URMD
 GB LED light bulb RO Bec LED
 D LED- Glühlampe H LED égő
 RUS Светодиодная лампочка E Bombilla LED



No.	W	lm	replacement / odpowiednik (W)	☐
83832	5	340	35	50/200

PL Lampa halogenowa
 GB Halogen lamp
 D Halogenstrahler
 RUS Галогенная фара-прожектор
 CZ Halogenové svítidlo
 RO Lampa cu halogen
 H Halogén lámpa
 E Lampara de halogeno

230V~
50Hz



No.	W	☐
82790	120	24
82791	400	16

PL Lampa halogenowa
 GB Halogen lamp
 D Halogenstrahler
 RUS Галогенная фара-прожектор
 CZ Halogenové svítidlo
 RO Lampa cu halogen
 H Halogén lámpa
 E Lampara de halogeno



No.	W	☐
82795	120	18
82796	400	12

PL Lampa halogenowa
 GB Halogen lamp
 D Halogenstrahler
 RUS Галогенная фара-прожектор
 CZ Halogenové svítidlo
 RO Lampa cu halogen
 H Halogén lámpa
 E Lampara de halogeno

230V~
50Hz



No.	W	☐
82792	120	24
82793	400	16

PL Lampa halogenowa
 GB Halogen lamp
 D Halogenstrahler
 RUS Галогенная фара-прожектор
 CZ Halogenové svítidlo
 RO Lampa cu halogen
 H Halogén lámpa
 E Lampara de halogeno



No.	W	☐
82797	120	18
82798	400	12

PL Lampa halogenowa przenośna
 GB Portable halogen projector
 D Halogenstrahler
 RUS Проектор галогенный переносный
 CZ Halogenové svítidlo přenosné
 RO Lampa cu halogen mobilă
 H Horozható halogén lámpa
 E Lampara de halogeno portatil

230V~
50Hz



No.	W	cable / kabel (m)	☐
82788	120	1.7	12
82789	400	1.7	8

PL Lampa halogenowa na stojaku
 GB Halogen projector on tripod
 D Halogenstrahler mit Stativ
 RUS Проектор галогенный на штативе
 CZ Halogenové svítidlo na stojanu
 RO Lampa cu halogen pe stativ
 H Állványos halogén lámpa
 E Lampara de halogeno sobre estante



230V~
50Hz



No.	W	☐
82786	400	4

- PL Lampa halogenowa na stojaku
- GB Halogen projector on tripod
- D Halogenstrahler mit Stativ
- RUS Проектор галогенный на штативе
- CZ Halogenové svítidlo na stojanu
- RO Lampa cu halogen pe stativ
- H Állványos halogén lámpa
- E Lampara de halogeno sobre estante

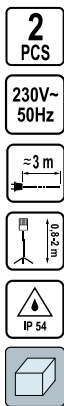

No.	W	pcs packing	box
82787	400	2	4

- PL Profesjonalna lampa warsztatowa
- GB Working lamp
- D Arbeitslampe
- RUS Лампа-переноска
- CZ Pracovní lampa
- RO Lampă pt. atelier
- H Szerelőlámpa
- E Lampara de taller



No.	W	type	box
82718	2x18	„MAGNUM 36“	1

- PL Zamki do lamp halogenowych
- GB Halogen projector bulbs
- D Halogenstab
- RUS Галогенная трубка
- CZ Halogenové svítidlo
- RO Bec cu halogen pt. projector
- H Halogén lámpazszo
- E Filamentos de bombillas halogenas



No.	W	lumens	h	box
82771	120	2200	1000	50/200
82772	400	8600	1000	50/200

- PL Lampa neonowa
- GB Working light
- D Werksattlatlampe
- RUS Лампа-переноска, люминесцентная
- CZ Neonová lampa
- RO Lampa neon
- H Neonlámpa
- E Lampara de neón



No.	W	type	box
82701	8	„ELECTRONIC“	20

- PL Lampa neonowa
- GB Working light
- D Werksattlatlampe
- RUS Лампа-переноска, люминесцентная
- CZ Neonová lampa
- RO Lampa neon
- H Neonlámpa
- E Lampara de neón



No.	W	type	box
82703	8	„PROFI“	6

- PL Lampa warsztatowa
- GB Working light
- D Werksattlatlampe
- RUS Лампа-переноска
- CZ Pracovní lampa
- RO Lampă pt. atelier
- H Szerelőlámpa
- E Lampara de taller



No.	W	type	box
82705	11	„EFFECT“	10

- PL Lampa warsztatowa
- GB Working light
- D Werksattlatlampe
- RUS Лампа-переноска
- CZ Pracovní lampa
- RO Lampă pt. atelier
- H Szerelőlámpa
- E Lampara de taller



No.	W	type	box
82713	100	„PRACTIC“	10

PL Lampa warsztatowa
GB Working light
D Werksattillampe
RUS Лампа-переноска

CZ Pracovní lampa
RO Lampă pt. atelier
H Szerelőlámpa
E Lampara de taller

230V



No.	W	type	
82715	60	„PLASTIC“	10

PL Lampa warsztatowa
GB Working light
D Werksattillampe
RUS Лампа-переноска

CZ Pracovní lampa
RO Lampă pt. atelier
H Szerelőlámpa
E Lampara de taller

230V



No.	W	type	
82712	60	„BASKET“	10

PL Lampa warsztatowa
GB Working light
D Werksattillampe
RUS Лампа-переноска

CZ Pracovní lampa
RO Lampă pt. atelier
H Szerelőlámpa
E Lampara de taller

230V



No.	W	type	
82714	60	„CLASSIC“	10

PL Lampa warsztatowa
GB Working light
D Werksattillampe
RUS Лампа-переноска

CZ Pracovní lampa
RO Lampă pt. atelier
H Szerelőlámpa
E Lampara de taller

230V



No.	W	type	
82716	60	„GUMMI“	10
82717	100	„GUMMI“	10

PL Reflektor diodowy
GB LED lamp
D Diodenscheinwerfer
RUS Светодиодный прожектор
CZ LED reflektor
RO Reflector diodă
H Diódás reflektor
E Reflector de diodos

LOW ENERGY CONSUMPTION
NISKIE ZUŻYCIE ENERGII
8W
130 LED
LED POWER 0.06 W
MOC DIODY
~220-240V 50Hz
585 lm
30 000-50 000 h
IP54



No.	W	led / diody	
82800	8	130	16

PL Reflektor diodowy z czujnikiem ruchu
GB LED lamp with motion detector
D Diodenscheinwerfer mit Bewegungsmelder
RUS Светодиодный прожектор с датчиком движения
CZ LED reflektor se snímačem pohybu
RO Reflector diodă cu senzor de mișcare
H Diódás reflektor mozgásérzékelővel
E Reflector de diodos con sensor de movimiento

LOW ENERGY CONSUMPTION
NISKIE ZUŻYCIE ENERGII
8W
130 LED
LED POWER 0.06 W
MOC DIODY
MOTION DETECTOR
CZUJNIK RUCHU
~220-240V 50Hz
585 lm
30 000-50 000 h
IP44



No.	W	led / diody	
82801	8	130	12

PL Diodowa lampa bezprzewodowa
GB Rechargeable work lamp
D Led werksattillampe
RUS Светодиодная беспроводная лампа

CZ 0 RQJN4Q 0P SD GRCRM EH Sřivodová
RO Lampa cu led fara cablu
H Ledlámpa
E Lámpara inalámbrica de diodos

36 LED 12V

500 mAh MAGNETIC

230V/50Hz BATTERY CHARGER ŁADOWARKA

HOOK



No.	LED	mAh	
82720	36	500	10/20

PL Diodowa lampa bezprzewodowa
GB Rechargeable work lamp
D Led werksattillampe
RUS Светодиодная беспроводная лампа
CZ 0 RQJN4Q 0P SD GRCRM EH Sřivodová
RO Lampa cu led fara cablu
H Ledlámpa
E Lámpara inalámbrica de diodos

27 LED 12V NiMH 500 mAh

230V/50Hz BATTERY CHARGER ŁADOWARKA HOOK

SHOCKPROOF

OILPROOF

WATERPROOF



No.	LED	mAh	
82721	27	500	10/20

- PL Diodowa lampa bezprzewodowa
- GB Rechargeable work lamp
- D Led werkstattlampe
- RUS Светодиодная беспроводная лампа
- CZ 0 RQMAQ OP SD GRCGM EH Sřivodov
- RO Lampa cu led fara cablu
- H Ledlmpa
- E Lmpara inalmbrica de diodos

60+17
LED

12V

**500
mAh**

230V/50Hz
BATTERY CHARGER
LDOWARKA

HOOK

SHOCKPROOF

OILPROOF

WATERPROOF



No.	LED	mAh	
82722	60+17	500	10/20

- PL Diodowa lampa bezprzewodowa
- GB Rechargeable work lamp
- D Led werkstattlampe
- RUS Светодиодная беспроводная лампа
- CZ 0 RQMAQ OP SD GRCGM EH Sřivodov
- RO Lampa cu led fara cablu
- H Ledlmpa
- E Lmpara inalmbrica de diodos

230V/50Hz
BATTERY CHARGER
LDOWARKA



No.	LED	mAh	type	
82725	27	1700	„JOKER”	10

- PL Diodowa latarka czolowa
- GB Led work lamp
- D Stirntaschenlampe
- RUS Налобный светодиодный фонарь
- CZ / HGP RQMAQ OP SD elovka
- RO Lampa cu led
- H Led fejlmpa
- E linterna de diodo

SHOCKPROOF

WATERPROOF

3x1.5V
(AAA)

8X
LED

ELASTIC
HEAD
STRAP



No.	battery / bateria	
88670	3x1.5V	12/72

- PL Diodowa latarka czolowa
- GB Led work lamp
- D Stirntaschenlampe
- RUS Налобный светодиодный фонарь
- CZ / HGP RQMAQ OP SD elovka
- RO Lampa cu led
- H Led fejlmpa
- E linterna de diodo

SHOCKPROOF

WATERPROOF

3x1.5V
(AAA)

17X
LED

ELASTIC
HEAD
STRAP



No.	battery / bateria	
88671	3x1.5V	12/72

- PL Diodowa latarka czolowa
- GB Led work lamp
- D Stirntaschenlampe
- RUS Налобный светодиодный фонарь
- CZ / HGP RQMAQ OP SD elovka
- RO Lampa cu led
- H Led fejlmpa
- E linterna de diodo

3x1.5V
(AAA)

HIGH
POWER
LED

3 LIGHTNING
MODES
3 TRYBY
SWIECENIA

ELASTIC
STRAP
ELASTICZNY
PASEK

1W
DIODA
DUZEJ
MOCY

1
LED



No.	battery / bateria	
88672	3x1.5V	12/60

- PL Diodowa latarka czolowa
- GB Led work lamp
- D Stirntaschenlampe
- RUS Налобный светодиодный фонарь
- CZ / HGP RQMAQ OP SD elovka
- RO Lampa cu led
- H Led fejlmpa
- E linterna de diodo

3x1.5V
(AAA)

3 LIGHTNING
MODES
3 TRYBY
SWIECENIA

ELASTIC
STRAP
ELASTICZNY
PASEK

SHOCK
PROOF
ODPORNA
NA WSTRZASY

HIGH
POWER
LED

WATER
PROOF
ODPORNA
NA WODE

1W
DIODA
DUZEJ
MOCY

1
LED



No.	battery / bateria	
88673	3x1.5V	12/48

- PL Diodowa latarka czolowa
- GB Led work lamp
- D Stirntaschenlampe
- RUS Налобный светодиодный фонарь
- CZ / HGP RQMAQ OP SD elovka
- RO Lampa cu led
- H Led fejlmpa
- E linterna de diodo

3x1.5V
(AAA)

3 LIGHTNING
MODES
3 TRYBY
SWIECENIA

ELASTIC
STRAP
ELASTICZNY
PASEK

SHOCK
PROOF
ODPORNA
NA WSTRZASY

HIGH
POWER
LED

WATER
PROOF
ODPORNA
NA WODE

1W
DIODA
DUZEJ
MOCY

1
LED



No.	battery / bateria	
88674	3x1.5V	12/48

Memo

22

Garden tools & power tools **Narzędzia i elektronarzędzia ogrodowe**

Watering program Program wodny

298-309



Garden hoses Wężę ogrodowe.....	298
Garden hose carts, holders & guides Wózki, stojaki i prowadnice do węży.....	298
Spray guns & lances Pistolety i lance zraszające.....	299
Spray nozzles Zraszacze.....	301
Garden showers Prysznice ogrodowe.....	304
Pumps Pompy.....	304
Water timers Sterowniki nawadniania.....	306
Connectors Złączki.....	306
Couplings Rozdzielacze.....	308
Sets Zestawy.....	309

Lawn care Pielęgnacja trawnika

310-314



Brush cutters Wykaszarki.....	310
Grass trimmers Podkaszarki.....	311
Gasoline lawn mowers Kosiarki spalinowe.....	311
Accu grass shears Akumulatorowe nożyce do trawy.....	312
Hand grass shears Ręczne nożyce do trawy.....	312
Lawn rakes Grabie wachlarzowe.....	312
Accessories Akcesoria.....	313

Trees and bushes care Pielęgnacja drzew i krzewów

314-323



Ladders Drabiny.....	314
Accu shrub shears Akumulatorowe nożyce do krzewów.....	314
Electric hedge trimmers Elektryczne nożyce do żywopłotu.....	315
Hand hedge shears Ręczne nożyce do żywopłotu.....	315
Gasoline hedge trimmers Spalinowe nożyce do żywopłotu.....	316
Garden pruners Sekatory ogrodowe.....	317
Lopping shears Sekatory do gałęzi.....	318

Saws for tall trees and bushes Piły do wysokich drzew i krzewów.....	319
Garden hand saws Piły ogrodowe ręczne.....	319
Sprayers Opryskiwacze.....	320
Petrol chain saws Pilarki spalinowe.....	321
Axes Siekiry.....	322
Wood splitters Kliny do rozłupywania drewna.....	323

Garden care Narzędzia do pielęgnacji ogrodu

323-337



Small garden tools Małe narzędzia ogrodowe.....	323
Sprayers Opryskiwacze.....	326
Garden hand saws Piły ogrodowe ręczne.....	327
Big garden tools Duże narzędzia ogrodowe.....	328

Health & safety products Artykuły BHP

337-341



Gloves Rękawice.....	337
Head, hearing & eyesight protection Ochrona głowy, słuchu i wzroku.....	338
Knee pads Nakolanniki.....	340
Rain boots Kalosze.....	341
Working clothes Odzież robocza.....	341

Winter season tools Narzędzia zimowe

342



Garden accessories Akcesoria ogrodowe

342-347

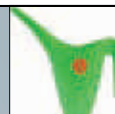

PL Wąż ogrodniczy
GB Garden hose
D Gartenschlauch
RUS Садовый шланг

CZ Zahradní hadice
RO Furtun de gradina
H Kerti tömlő
E Manguera de jardín

8 bar

20 bar
BURSTING PRESSURE
CIŚNIENIE ROZRYWAJĄCE

TEMPERATURE TOLERANCE
ODPORNOŚĆ NA TEMPERATURĘ
-10°C ÷ +60°C

UV PROOF
ODPORNOŚĆ NA PROMIENIOWANIE UV



No.	L (m)	Ø	☐
89302	20	1/2" (12.5 mm)	1
89303	30	1/2" (12.5 mm)	1
89305	50	1/2" (12.5 mm)	1
89307	20	3/4" (19.0 mm)	1
89308	30	3/4" (19.0 mm)	1
89310	50	3/4" (19.0 mm)	1
89298	20	1" (25.0 mm)	1
89299	30	1" (25.0 mm)	1
89300	50	1" (25.0 mm)	1

PL Wąż ogrodniczy
GB Garden hose
D Gartenschlauch
RUS Садовый шланг

CZ Zahradní hadice
RO Furtun de gradina
H Kerti tömlő
E Manguera de jardín

ALGAE
SETTLING
PROOF

ODPORNOŚĆ NA
OSADZANIE SIĘ
GLONÓW

20 bar
BURSTING PRESSURE
CIŚNIENIE ROZRYWAJĄCE

UV PROOF
ODPORNOŚĆ NA
PROMIENIOWANIE UV

TEMPERATURE TOLERANCE
ODPORNOŚĆ NA TEMPERATURĘ
-40°C ÷ +70°C



No.	L (m)	Ø	☐
89311	20	1/2" (12.5 mm)	1
89312	30	1/2" (12.5 mm)	1
89313	50	1/2" (12.5 mm)	1
89314	20	3/4" (19.0 mm)	1
89315	30	3/4" (19.0 mm)	1
89316	50	3/4" (19.0 mm)	1
89318	20	1" (25.0 mm)	1
89319	30	1" (25.0 mm)	1
89320	50	1" (25.0 mm)	1

PL Opaska ślimakowa do węża
GB Hose clip
D Schlauchklemme
RUS Хомут стальной

CZ Šneková páska
RO Colier metalic
H Csigapánt
E Abrazadora

4 PCS



No.	Ø (mm)	for hose / do węża Ø	pcs	☐
73506	12-20	1/2" (12.5 mm)	4	20
73507	16-25	3/4" (19.0 mm)	4	20
73508	20-32	1" (25.0 mm)	4	20
73510	12-20	1/2" (12.5 mm)	4	20
73511	16-25	3/4" (19.0 mm)	4	20
	20-32	1" (25.0 mm)	4	20

PL Stojak do węża ogrodowego
GB Hose holder
D Gartenschlauchträger
RUS Барабан для намотки поливочного шланга

CZ Stojan navjecd na zahradní hadici
RO Suport pt. furtun
H Utartódob locsolótömlőhöz
E Estante para manguera de jardín

PP

Ø 5/8" (16.0 mm)
30m

Ø 1/2" (12.5 mm)
45m

Ø 5/8" (16.0 mm)
45m

Ø 1/2" (12.5 mm)
60m

89330

89331



No.	size / rozmiar	☐
89330	5/8" (16.0 mm) / 30m; 1/2" (12.5 mm) / 45m	5
89331	5/8" (16.0 mm) / 45m; 1/2" (12.5 mm) / 60m	5

PL Wózek do węża ogrodowego
GB Hose cart
D Gartenschlauchwagen
RUS Барабан для намотки поливочного шланга

CZ Stojan navjecd na zahradní hadici
RO Suport pt. furtun
H Utartódob locsolótömlőhöz
E Carretilla para manguera de jardín

Ø 5/8" (16.0 mm)
30m

Ø 1/2" (12.5 mm)
45m

89335

Ø 5/8" (16.0 mm)
45m

Ø 1/2" (12.5 mm)
60m

89336



No.	size / rozmiar	☐
89335	5/8" (16.0 mm) / 30m; 1/2" (12.5 mm) / 45m	5
89336	5/8" (16.0 mm) / 45m; 1/2" (12.5 mm) / 60m	5

PL Wąż spiralny z pistoletem zraszającym
GB Coil hose set with spray gun
D Spiralschlauch mit multifunktionsbrause
RUS Спиральный шланг в наборе с пистолетом

CZ Pistof striekacia s vinutou hadicou
RO Furtun in spirala cu pistol pt. stropit
H Locsoló pisztoló tömlővel
E Manguera espiral con rociador

15m

COIL HOSE SPIRALNY WĄŻ

EVA

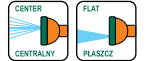
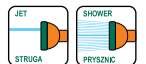

No.	L (m)	☐
89351	15	8

PL Zestaw do podlewania
GB Watering set
D Bewässerung kit
RUS Набор для полива
CZ Zalévání kit
RO Kit de udare
H Locsoló készlet
E Set de riego con manguera



3/4" (19,0mm) 8.5 mm
 10m
 CONE STÓZEK FLAT PLASZCZ
 SHOWER PRYSZCZ MIST MGIELKA
 CENTER CENTRALNY
 SOAKER PODLEWANIE ANGLE KĄTOWY JET STRUGA

No.	L (m)	
89342	10	8

PL Wieszak na wąż ogrodowy
GB Hose hanger
D Gartenschlauchträger
RUS Кронштейн настенный для шланга

CZ Věšák na hadici zahradní
RO Suport de perete pt. furtun
H Kerítömölő-akasztó
E Colgador para manguera de jardín

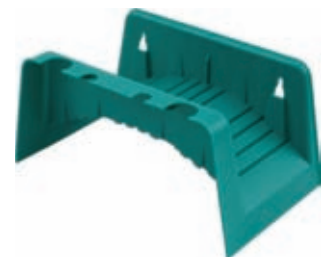

ABS

No.	
89345	60

PL Prowadnica węża
GB Hose guide
D Schlauchcheckführung
RUS Направляющее приспособление для шланга

CZ Vodítka s rolnami na hadici
RO Ghidaj pt. furtun
H Tömöl vezető
E Guíddera para manguera



No.	
89348	6/24

PL Prowadnica do węża ogrodowego
GB Hose guide
D Regelbare Sprühpistole
RUS Направляющее приспособление для шланга

CZ Vodítka s rolnami na hadici
RO Ghidaj pt. furtun
H Tömöl vezető
E Guíddera para manguera



ZINC ALLOY SPIKE
KOLEC ZE STOPU CYNKU

No.	
89347	12/48

PL Pistolet zraszający regulowany
GB Adjustable spray gun
D Regelbare Sprühpistole
RUS Регулируемый оросительный пистолет

CZ Kropící pistole regulovatelná
RO Pistolet de irigare ajustabil
H Öntöző pisztoly, állítható sugarú
E Pistola rociadora ajustable



ZINC ALLOY STOP CYNKU TPR

CENTER CENTRALNY
 CONE STÓZEK
 MIST MGIELKA

No.	
89190	12/48

PL Pistolet zraszający regulowany
GB Adjustable spray gun
D Regelbare Sprühpistole
RUS Регулируемый оросительный пистолет

CZ Kropící pistole regulovatelná
RO Pistolet de irigare ajustabil
H Öntöző pisztoly, állítható sugarú
E Pistola rociadora ajustable



CENTER CENTRALNY
 CONE STÓZEK
 MIST MGIELKA

No.	
89189	12/48

PL Pistolet zraszający regulowany
GB Adjustable spray gun
D Regelbare Sprühpistole
RUS Регулируемый оросительный пистолет

CZ Kropící pistole regulovatelná
RO Pistolet de irigare ajustabil
H Öntöző pisztoly, állítható sugarú
E Pistola rociadora ajustable



CENTER CENTRALNY
 CONE STÓZEK
 MIST MGIELKA

No.	
89193	12/48

PL Pistolet zraszający regulowany
GB Adjustable spray gun
D Regelbare Sprühpistole
RUS Регулируемый оросительный пистолет

CZ Kropící pistole regulovatelná
RO Pistolet de irigare ajustabil
H Öntöző pisztoly, állítható sugarú
E Pistola rociadora ajustable



ZINC ALLOY STOP CYNKU TPR

CENTER CENTRALNY
 CONE STÓZEK
 MIST MGIELKA

No.	
89194	6/24

PL Pistolet zraszający regulowany
GB Adjustable spray gun
D Regelbare Sprühpistole
RUS Регулируемый оросительный пистолет

CZ Kropící pistole regulovatelná
RO Pistolet de irigare ajustabil
H Öntöző pisztoly, állítható sugárú
E Pistola rociadora ajustable

ABS
 CENTER
 CENTRALNY
 CONE
 STOZEK
 MIST
 MGIELKA



FLO

No. 89210 12/48

PL Pistolet zraszający regulowany
GB Adjustable spray gun
D Regelbare Sprühpistole
RUS Регулируемый оросительный пистолет

CZ Kropící pistole regulovatelná
RO Pistolet de irigare ajustabil
H Öntöző pisztoly, állítható sugárú
E Pistola rociadora ajustable

ABS
 CENTER
 CENTRALNY
 CONE
 STOZEK
 MIST
 MGIELKA



FLO

No. 89213 12/48

PL Pistolet zraszający regulowany
GB Adjustable spray gun
D Regelbare Sprühpistole
RUS Регулируемый оросительный пистолет

CZ Kropící pistole regulovatelná
RO Pistolet de irigare ajustabil
H Öntöző pisztoly, állítható sugárú
E Pistola rociadora ajustable

BRASS MOSIÁDZ
ABS
 CENTER
 CENTRALNY
 CONE
 STOZEK
 MIST
 MGIELKA



FLO

No. 89215 12/24

PL Wielofunkcyjny pistolet zraszający
GB Multifunction sprinkling gun
D Multifunktions-Spritzpistole
RUS Многофункциональный оросительный пистолет

CZ Multifunkční postřikovací pistole
RO Pistol multifuncțional pt. pulverizare
H Többfunkciós öntöző pisztoly
E Pistola para regar multifuncional

ZINC ALLOY STOP CYNKU
TPR
 FULL STRUMIEN CENTRALNY
 MIST MGIELKA
 CONE STOZEK
 PRYSZNC
 SHOWER PRYSZNC
 SOAKER PODLEWANIE
 FLAT PLASZCZ
 JET STRUGA



FLO

No. 89192 12/48

PL Wielofunkcyjny pistolet zraszający
GB Multifunction sprinkling gun
D Multifunktions-Spritzpistole
RUS Многофункциональный оросительный пистолет

CZ Multifunkční postřikovací pistole
RO Pistol multifuncțional pt. pulverizare
H Többfunkciós öntöző pisztoly
E Pistola para regar multifuncional

ZINC ALLOY STOP CYNKU
TPR
 CENTER CENTRALNY
 JET STRUGA
 SHOWER PRYSZNC
 MIST MGIELKA
 FLAT PLASZCZ
 SOAKER PODLEWANIE
 CONE STOZEK



FLO

No. 89191 12/48

PL Wielofunkcyjny pistolet zraszający
GB Multifunction sprinkling gun
D Multifunktions-Spritzpistole
RUS Многофункциональный оросительный пистолет

CZ Multifunkční postřikovací pistole
RO Pistol multifuncțional pt. pulverizare
H Többfunkciós öntöző pisztoly
E Pistola para regar multifuncional

ZINC ALLOY STOP CYNKU
TPR
 CONE STOZEK
 VERTICAL WERZKOLKOWY
 CENTER CENTRALNY
 FLAT PLASZCZ
 STREAM STRUMIEN
 FULL STRUMIEN CENTRALNY
 MIST MGIELKA
 SHOWER PRYSZNC



FLO

No. 89195 6/24

PL Pistolet zraszający
GB Sprinkling gun
D Spritzpistole
RUS Оросительный пистолет

CZ Postřikovací pistole
RO Pistol pt. pulverizare
H Öntöző pisztoly
E Pistola para regar

ABS
 SHOWER PRYSZNC



FLO

No. 89209 12/48

PL Wielofunkcyjny pistolet zraszający
GB Multifunction sprinkling gun
D Multifunktions-Spritzpistole
RUS Многофункциональный оросительный пистолет

CZ Multifunkční postřikovací pistole
RO Pistol multifuncțional pt. pulverizare
H Többfunkciós öntöző pisztoly
E Pistola para regar multifuncional

ABS
 FULL STRUMIEN CENTRALNY
 SHOWER PRYSZNC
 FLAT PLASZCZ
 CENTER CENTRALNY
 JET STRUGA
 MIST MGIELKA



FLO

No. 89220 12/48

PL Lanca zraszająca wielofunkcyjna
 GB Sprinkling lance
 D Multifunktions-Spritzstab
 RUS Пика для распылителя многофункциональная
 CZ Multifunkční postřikovací nástavec
 RO Tijă pt. irigare
 H Többfunkciós esőztető fej
 E Lanca para regar multifuncional

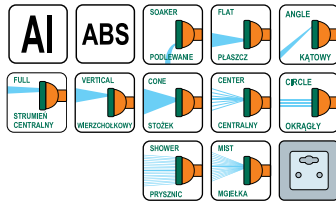

No.		
89218		12

PL Lanca zraszająca wielofunkcyjna
 GB Sprinkling lance
 D Multifunktions-Spritzstab
 RUS Пика для распылителя многофункциональная
 CZ Multifunkční postřikovací nástavec
 RO Tijă pt. irigare
 H Többfunkciós esőztető fej
 E Lanca para regar multifuncional

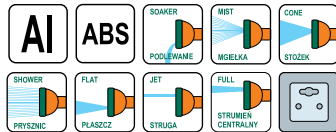

No.		
89219		12

PL Prysznik ogrodowy
 GB Garden shower
 D Gartendusche
 RUS Распылитель садовый
 CZ Zahradní sprcha
 RO Duș pt. grădina
 H Kerti zuhany
 E Regadera para jardín



No.		
89390		6

PL Zraszacz prosty regulowany
 GB Adjustable spray nozzle
 D Spritze
 RUS Распылитель поливочный

CZ Postřikovač
 RO Stropitor apă
 H Szórófej
 E Rociador



No.		packing	
89201		<input type="checkbox"/>	25/100
89202		<input type="checkbox"/>	12/48

PL Zraszacz prosty regulowany
 GB Adjustable spray nozzle
 D Spritze
 RUS Распылитель поливочный

CZ Postřikovač
 RO Stropitor apă
 H Szórófej
 E Rociador



No.		
89187		48

PL Zraszacz prosty regulowany
 GB Adjustable spray nozzle
 D Spritze
 RUS Распылитель поливочный

CZ Postřikovač
 RO Stropitor apă
 H Szórófej
 E Rociador

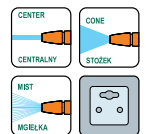

No.		
89188		12/24

PL Zraszacz impulsowy
GB Impulse sprinkler
D Impulsregner
RUS Распылитель импульсный на пике

CZ Postřikovač
RO Stropitor apă
H Impulzus szórófej
E Rociador

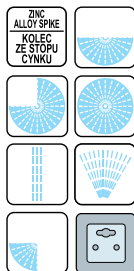

No.	
89260	12/48

PL Zraszacz impulsowy
GB Impulse sprinkler
D Impulsregner
RUS Распылитель импульсный на пике

CZ Postřikovač
RO Stropitor apă
H Impulzus szórófej
E Rociador

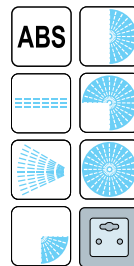

No.	
89261	12/48

PL Zraszacz 3-ramienny
GB 3-arms revolving sprinkler
D 3-Arm Kreis-Regner
RUS Трехсторонний вращающийся распылитель на пике
CZ Rozprašovateľtriramenny
RO Aspersol cu 3 brate
H Locsoló, leszűrhető, forgó
E Rociador 3-brazos



No.	
89262	12/48

PL Zraszacz 3-ramienny
GB 3-arm revolving sprinkler with spike
D 3-arm Kreis-Regner
RUS Трехсторонний вращающийся распылитель на пике
CZ Rozprašovateľtriramenny
RO Aspersol cu 3 brate
H Locsoló, leszűrhető, forgó
E Rociador 3-brazos



No.	
89263	12/48

PL Zraszacz impulsowy naziemny
GB Impulse sprinkler with base
D Impulsregner
RUS Распылитель импульсный
CZ Postřikovač
RO Stropitor apă
H Impulzus szórófej
E Rociador

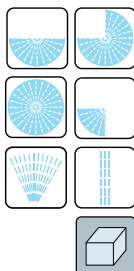

No.	
89266	24

PL Zraszacz impulsowy naziemny
GB Impulse sprinkler with base
D Impulsregner
RUS Распылитель импульсный
CZ Postřikovač
RO Stropitor apă
H Impulzus szórófej
E Rociador

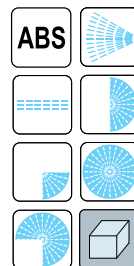

No.	
89268	24

PL Zraszacz 8-funkcyjny
 GB 8 pattern sprinkler
 D 8-Flächenregner
 RUS Распылитель 8-позиционный на подставке
 CZ Postřikovač
 RO Stropitor apă cu 8 duze
 H 8 funkcióú szórófej
 E Roclador 8-funciones de tierra



No.	
89265	24/48

PL Zraszacz 3-ramienny naziemny
 GB 3-arms revolving sprinkler on base
 D 3-Arm Kreis-Regner
 RUS Трёхсторонний вращающийся распылитель на подставке

CZ Rozprašovač třiramenný
 RO Aspersor cu 3 brate
 H Locsoló, leszűrhető, forgó
 E Roclador 3-brazos

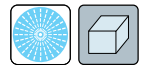

No.	
89267	24

PL Zraszacz "Szalona stokrotka"
 GB Garden sprayer „Crazy Daisy”
 D Garten sprinkler
 RUS Распылитель
 CZ Sprcha zahradni
 RO Stropitor
 H Kerti locsoló
 E Roclador



No.	
99351	12

PL Zraszacz wynurzalny
 GB Impulse pop-up sprinkler
 D Tauchimpulssprinkler
 RUS Дождеватель выдвижной

CZ = DIVERZ výsuvný
 RO Aspersor cu impuls
 H Esőztető szórófej
 E Roclador de emerjer



No.	
89280	12

PL Zraszacz prosty
 GB Straight nozzle
 D Spritze
 RUS Распылитель поливочный

CZ Postřikovač
 RO Stropitor apă
 H Szórófej
 E Roclador simple



No.	size / rozmiar	
89120	1/2" (12.5 mm)	48

PL Zraszacz z wysięgnikiem
 GB Multi-purpose spray lance
 D Spritzglessstab
 RUS Распылитель с удлинителем
 CZ Postřikovač s prodloužením
 RO Pistol de stropit cu extensie
 H Üntözőfej hosszabító szárral
 E Roclador con brazo

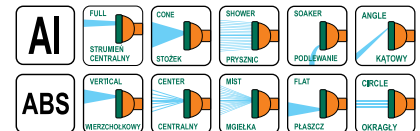

No.	
89218	12

PL Zraszacz z wysięgnikiem
 GB Telescopic garden shower
 D Spritzglessstab
 RUS Распылитель с удлинителем
 CZ Postřikovač s prodloužením
 RO Pistol de stropit cu extensie
 H Üntözőfej hosszabító szárral
 E Roclador con brazo

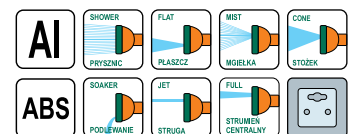

No.	
89219	12

- PL Prysznic ogrodowy
 GB Telescopic garden shower with tripod
 D Gärtendusche
 RUS Телескопическая садовая поливалка на треноге
 CZ Zahradní sprcha
 RO Dus pt. gradina cu suport telescopic
 H Teleszkópos kerti zuhany háromszög állvánnyal
 E Regadera para jardines

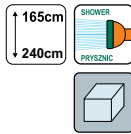

No.	
89390	6

- PL Pompa zatapialna do wody brudnej
 GB Dirty water submersible pump
 D Tauchmotorpumpe
 RUS Погружной насос
 CZ Zatavovací čerpadlo
 RO Pompă pt. apă murdară
 H Bűvárszivattyú
 E Bomba de inmersión para agua sucia

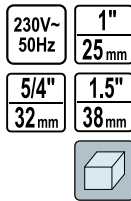

No.	W	l / h	H (max)	
79890	400	7500	5	4
79891	550	10500	7	4
79892	750	13000	9	2
79893	900	14000	10	2
79894	1100	15000	11	2

- PL Pompa zatapialna do wody brudnej
 GB Dirty water submersible pump
 D Tauchmotorpumpe für schmutzwasser
 RUS Погружной насос для грязной воды
 CZ Ponorné čerpadlo na špinavou vodu
 RO Pompa submersibilă pt. apă murdară
 H Bűvárszivattyú
 E Bomba sumergible para aguas sucias



No.	W	l / h	H (max)	
79880	450	16000	9	1

- PL Pompa ręczna
 GB Hand pump
 D Schwingelpumpe
 RUS Насос ручной
 CZ Pumpa ruční
 RO Pompa manuală
 H Kéziszivattyú
 E Bomba de mano



No.	
89552	1

- PL Podstawa pod pompę
 GB Pump base
 D Pumpenständer
 RUS Подставка для насоса
 CZ Podstavec pumpy
 RO Suport pt. pompa
 H Szivattyútalp
 E Soporte para bomba



No.	for / dia	
89553	89552	1

- PL Pompa zatapialna do wody brudnej
 GB Dirty water submersible pump
 D Tauchmotorpumpe
 RUS Погружной насос
 CZ Zatavovací čerpadlo
 RO Pompă pt. apă murdară
 H Bűvárszivattyú
 E Bomba de inmersión para agua sucia

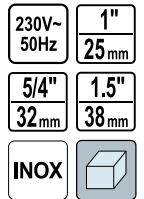

No.	W	l / h	H (max)	
79896	550	12500	8	2
79897	750	13000	9	2
79898	900	14500	10	2
79899	1100	15500	11	2

- PL Pompa zatapialna do wody brudnej
- GB Dirty water submersible pump
- D Tauchmotorpumpe für schmutzwasser
- RUS Погружной насос для грязной воды
- CZ Ponorné čerpadlo na špinavú vodu
- RO Pompa submersibilă pt. apă murdară
- H Bűvárszivattyú
- E Bomba sumergible para aguas sucias

230V~50Hz 750 W



No.	W	l / h	H (max)	
79883	750	16000	13	1

- PL Pompa ogrodowa
- GB Jet pump
- D Gartenpumpe
- RUS Насос садовый

- CZ Zahradní čerpadlo
- RO Pompa apa
- H Kerli szivattyúhoz
- E Bomba de jardín con cabeza

230V~50Hz



$L_{pA} = 67,5 \pm 3,0$ dB; $L_{wA} = 78,5 \pm 3,0$ dB

No.	W	l / h	H (max)	max. pressure / max. ciśnienie (bar)	
79912	600	2800	35	3.5	1
79913	800	3200	40	4.0	1
79914	1000	3500	44	4.4	1

- PL Pompa fontanna
- GB Fountain pump
- D Springbrunnenpumpe
- RUS Фонтанный насос
- CZ Fontánová pumpa
- RO Pompa pt. fantana arteziána
- H Pumpa szökőkúthoz
- E Bomba para las fuentes

230V~50Hz

3 NOZZLES DYSZE

IPX8



No.	W	l / h	H (max)	
79926	8	600	1.0	12
79927	16	800	1.3	12
79928	22	1000	1.6	12

- PL Pompa fontanna
- GB Fountain pump
- D Springbrunnenpumpe
- RUS Фонтанный насос
- CZ Fontánová pumpa
- RO Pompa pt. fantana arteziána
- H Pumpa szökőkúthoz
- E Bomba para las fuentes

230V~50Hz

5 NOZZLES DYSZE

IPX8



No.	W	l / h	H (max)	
79929	28	1400	2.0	8
79930	40	1800	2.5	8

- PL Pompa fontanna
- GB Fountain pump
- D Springbrunnenpumpe
- RUS Фонтанный насос
- CZ Fontánová pumpa
- RO Pompa pt. fantana arteziána
- H Pumpa szökőkúthoz
- E Bomba para las fuentes

230V~50Hz

CABLE 10m

IP68

5 NOZZLES



No.	W	l / h	H (max)	
79931	55	2000	2.5	8
79932	85	3000	3.5	8
79933	100	4500	4.5	6

PL Wąż odpływowy do pomp
GB Pump drain hose
D Abflussschlauch für die Pumpen
RUS Сливной шланг для насосов

CZ Výtlačná hadice pro čerpadla
RO Furtun de evacuare pt. pompe
H Eلفoly tömlő szivattyúhoz
E Manguera de salida para bombas



No.	L (m)	Ø	wall thickness / grubość ścianki	
79960	10	1" (25 mm)	1.2	15
79962	20	1" (25 mm)	1.2	8
79963	30	1" (25 mm)	1.2	6
79965	50	1" (25 mm)	1.2	3
79968	20	5/4" (32 mm)	1.4	6
79969	30	5/4" (32 mm)	1.4	6
79971	50	5/4" (32 mm)	1.4	3
79973	20	3/2" (38 mm)	1.8	4
79975	50	3/2" (38 mm)	1.8	2

PL Czasowy wyłącznik przepływu wody
GB Water timer
D Bewässerunguhr
RUS Таймер для управления подачей воды

CZ =DMARYDFLKRCIG
RO Programator automat
H Vizprogramozó óra
E Programador manual para tubos de agua



No.	size / rozmiar	
89281	1/2"; 3/4"; 1" (12.5; 19.0; 25.0 mm)	24

PL Złącze
GB Hose connector
D Universal
RUS Соединитель

CZ Rychlospojka
RO Mufă pt. pistol
H Fitting
E Junta estandar



No.	size / rozmiar	packing	
89221	1/2" (12.5 mm)		150/600
89222	1/2" (12.5 mm)		24/288
89223	3/4" (19.0 mm)		60/240
89224	3/4" (19.0 mm)		24/288

PL Złącze
GB Hose connector
D Universal
RUS Соединитель

CZ Rychlospojka
RO Mufă pt. pistol
H Fitting
E Junta estandar



No.	size / rozmiar	packing	
89225	1/2" (12.5 mm)		150/600
89226	1/2" (12.5 mm)		24/288
89227	3/4" (19.0 mm)		60/240
89228	3/4" (19.0 mm)		24/288

PL Reparatör do węża
GB Hose mender
D Schlauchreparatur
RUS Соединитель шлангов

CZ Opravka
RO Mufă înădire
H Gyorstoldó
E Reparador para manguera



No.	size / rozmiar	packing	
89229	1/2" (12.5 mm)		60/240
89230	1/2" (12.5 mm)		24/288
89231	3/4" (19.0 mm)		60/240
89232	3/4" (19.0 mm)		24/288

PL Przyłącze do kranu
GB Snap-in tap adaptor
D Wasserhahnanschluss für Gartenschlauch
RUS Адаптер внешний

CZ Šroubení
RO Mufă pt. robinet cu filet interior
H Tömlovég csaphoz
E Tubuladura de grifo



No.	size / rozmiar	
89253	1/2" (12.5 mm)	24/240

PL Przyłącze do kranu
GB Snap-in tap adaptor
D Wasserhahnanschluss für Gartenschlauch
RUS Адаптер для крана

CZ Šroubení
RO Mufă pt. robinet cu filet interior
H Tömlovég csaphoz
E Tubuladura de grifo



No.	size / rozmiar	packing	
89235	1/2"; 3/4" (12.5; 19 mm)		250/1000
89236	1/2"; 3/4" (12.5; 19 mm)		24/288

- PL Przyłącze do kranu
 GB Snap-in tap adaptor
 D Wasserhahnanschluss für Gartenschlauch
 RUS Адаптер для крана
 CZ Sroubení
 RO Mufă pt. robinet cu filet interior
 H Tömlovég csaphoz
 E Tubuladura de grifo

1/2" 12.5 mm
 3/4" 19.0 mm

ABS



No.	size / rozmiar	packing	
89241	1/2"; 3/4" (12.5; 19 mm)		250/1000
89242	1/2"; 3/4" (12.5; 19 mm)		24/288

- PL Przyłącze do kranu
 GB Snap-in tap adaptor
 D Wasserhahnanschluss mit Reduktion
 RUS Адаптер для крана
 CZ Sroubení
 RO Mufă pt. robinet cu filet interior
 H Tömlovég csaphoz
 E Tubuladura de grifo

3/4" 19.0 mm
 1" 25.0 mm

ABS



No.	size / rozmiar	packing	
89251	3/4"; 1" (19.0; 25.0 mm)		100/1000
89252	3/4"; 1" (19.0; 25.0 mm)		24/288

- PL Nypel
 GB Male connector
 D Anschlussgerätestück
 RUS Адаптер внутренний

- CZ Spojka
 RO Mufă pt. robinet cu filet exterior
 H Külső menetestölvég
 E Nypel

3/4" 19 mm

ABS



No.	size / rozmiar	packing	
89239	3/4" (19.0 mm)		250/1000
89240	3/4" (19.0 mm)		24/288

- PL Złącze mosiężne
 GB Brass hose connector
 D Schlauch-Schnellkupplung
 RUS Быстрьюемная муфта

- CZ Rychlospojka
 RO Manșon de îmbinare
 H Csatlakozó
 E Conexión

1/2" 12.5 mm

BRASS MOSIADZ



No.	size / rozmiar	
89100	1/2" (12.5 mm)	48

- PL Złącze mosiężne stop
 GB Brass hose connector
 D Schlauch-Schnellkupplung
 RUS Быстрьюемная муфта

- CZ Rychlospojka
 RO Manșon de îmbinare
 H Csatlakozó
 E Conexión

1/2" 12.5 mm

BRASS MOSIADZ

STOP



No.	size / rozmiar	
89101	1/2" (12.5 mm)	48

- PL Złącze mosiężne
 GB Brass hose connector
 D Schlauch-Schnellkupplung
 RUS Быстрьюемная муфта

- CZ Rychlospojka
 RO Manșon de îmbinare
 H Csatlakozó
 E Conexión

3/4" 19 mm

BRASS MOSIADZ



No.	size / rozmiar	
89102	3/4" (19 mm)	48

- PL Złącze mosiężne stop
 GB Brass hose connector
 D Schlauch-Schnellkupplung
 RUS Быстрьюемная муфта

- CZ Rychlospojka
 RO Manșon de îmbinare
 H Csatlakozó
 E Conexión

3/4" 19 mm

BRASS MOSIADZ

STOP



No.	size / rozmiar	
89103	3/4" (19 mm)	48

- PL Reparatör do żeża
 GB Hose mender
 D Schlauchreparaturstück
 RUS Соединитель шлангов

- CZ Opravka
 RO Mufă înădire
 H Csatlakozó
 E Reparatör para manguera

BRASS MOSIADZ



No.	size / rozmiar	
89104	1/2" (12.5 mm)	48
89105	3/4" (19.0 mm)	48

PL Przyłącze do kranu
GB Snap-in tap adaptor
D Wasserhahnanschluss für Gartenschlauch
RUS Адаптер для крана

CZ Šroubení
RO Mufă pt. robinet cu filet interior
H Tömölvég csaphoz
E Tubuladura de grifo

BRASS
MOSIADZ



No.	size / rozmiar	
89106	3/4" (19 mm)	48
89107	1" (25 mm)	48

PL Przyłącze do kranu
GB Snap-in tap adaptor
D Wasserhahnanschluss für Gartenschlauch
RUS Адаптер для крана

CZ Šroubení
RO Mufă pt. robinet cu filet interior
H Tömölvég csaphoz
E Tubuladura de grifo

BRASS
MOSIADZ



No.	size / rozmiar	
89108	1/2" 3/4" (12.5; 19.0 mm)	48
89109	3/4" 1" (19.0; 25.0 mm)	48

PL Nypel
GB Male connector
D Anschlussgerätestück
RUS Адаптер внутренний

CZ Spojka
RO Mufă pt. robinet cu filet exterior
H „Y” típusú elágazás
E Nypel

3/4"
19 mm

BRASS
MOSIADZ



No.	size / rozmiar	
89110	3/4" (19 mm)	48

PL Złącze typu „I”
GB 2 way coupling
D Doppelkupplung
RUS Соединитель шлангов

CZ Spojka
RO Prelungitor furtun apă
H „I” típusú csőtoldaló idom
E Junta tipo „I”

1/2"
12.5 mm

ABS



No.	packing	
89245		125/500
89246		24/288

PL Rozdzielacz typu „Y”
GB 3 way coupling
D Drei wege Kupplung
RUS Тройник для шлангов

CZ Y-kus
RO Distributor 3 căi
H „Y” típusú elágazás
E Distribuidor tipo „Y”

ABS



No.	packing	
89243		125/250
89244		24/288

PL Rozdzielacz z zaworami
GB Y-switch coupling with swivel
D 2-Wege Ventil
RUS Распределитель внешний

CZ Rozbočovač s uzavíracími ventily
RO Racord liny cu robinet
H Y-elágazó, 2 db külső menetes elzáróval
E Distribuidor tipo „Y”

1/2"
12.5 mm



No.	size / rozmiar	packing	
89247	1/2" (12.5 mm)		24/240
89248	1/2" (12.5 mm)		12/96

PL Reparatör do węży
GB Hose mender
D Schlauchverbinder mit Reduktion
RUS Соединитель шлангов

CZ Opravka
RO Mufă înădrire
H Györstoldó
E Reparatör para manguera

3/4"
19.0 mm
1/2"
12.5 mm

ABS



No.	size / rozmiar	packing	
89233	3/4"; 1/2" (19.0; 12.5 mm)		60/240
89234	3/4"; 1/2" (19.0; 12.5 mm)		24/288

PL Złącze typu „I”
GB 2 way coupling
D Doppelkupplung
RUS Переходник

CZ Spojka
RO Prelungitor furtun apă
H „I” típusú csőtoldaló idom
E Junta tipo „I”

1/2"
12.5 mm

BRASS
MOSIADZ



No.	size / rozmiar	
89113	1/2" (12.5 mm)	48

PL Rozdzielacz typu „Y”
GB 3 way coupling
D Drei wege kupplung
RUS Тройник для шлангов

CZ Y-kus
RO Distribuitor 3 căi
H „Y” típusú elágazás
E Distribuidor tipo „Y”

1/2"
12,5mm

BRASS
MOSIĄDZ



No.	size / rozmiar	
89112	1/2" (12.5 mm)	48

PL Zestaw złączek ze zraszaczem prostym
GB Basic hose set with straight nozzle
D Bewässerungs Spritz und Anschlussset
RUS Набор поливочный

CZ Postřikovač + spojky
RO Ștut furtun apă cu accesorii pt. robinet
H Készlet gyorskapocsal csaphoz
E Juego de rociar tubuladura de grifo

4
PCS

ABS



No.	size / rozmiar	pcs
89203	1/2"; 3/4" (12.5; 19 mm)	4 12/72

PL Zestaw złączek ze zraszaczem prostym
GB Basic hose set with straight nozzle
D Bewässerungs Spritz und Anschlussset
RUS Набор поливочный

CZ Postřikovač + spojky
RO Ștut furtun apă cu accesorii pt. robinet
H Készlet gyorskapocsal csaphoz
E Juego de rociar tubuladura de grifo

4
PCS

ABS



No.	size / rozmiar	pcs
89204	1/2" (12.5 mm)	4 12/72

PL Zestaw złączek ze zraszaczem pistoletowym
GB Basic hose set with adjustable spray gun
D Spritzbrause und Anschlussset
RUS Набор поливочный

CZ Rozprašovaci pistole na vodu + spojky
RO Pistol reglabil cu și accesorii
H Résztes készlet – os tömlőhöz
E Juego de rociar para manguera

4
PCS

ABS



No.	size / rozmiar	pcs
89206	1/2" (12.5 mm)	4 12/48

PL Zestaw złączek ze zraszaczem pistoletowym
GB Basic hose set with adjustable spray gun
D Spritzbrause und Anschlussset
RUS Набор поливочный
CZ Rozprašovaci pistole na vodu + spojky
RO Pistol reglabil cu și accesorii
H Résztes készlet – os tömlőhöz
E Juego de rociar para manguera

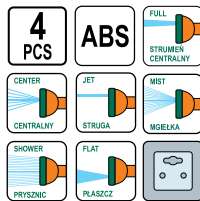

No.	size / rozmiar	pcs
89207	3/4"; 1/2" (19.0; 12.5 mm)	4 12/48

PL Zestaw złączek ze zraszaczem pistoletowym
GB Basic hose set with adjustable spray gun
D Spritzbrause und Anschlussset
RUS Набор поливочный

CZ Rozprašovaci pistole na vodu + spojky
RO Pistol reglabil cu și accesorii
H Résztes készlet – os tömlőhöz
E Juego de rociar para manguera

4
PCS

ABS



No.	size / rozmiar	pcs
89208	1/2" (12.5 mm)	4 12/48

PL Zestaw uszczelek
GB Set of gaskets
D Dichtungssatz
RUS Набор прокладок

CZ Sada těsnění
RO Set de garnituri
H Tömítéskészlet eszétetőhöz
E Juego de juntas

14
PCS



No.	pcs	for / dla
89270	14	89100-89267 20/80

- PL Wielofunkcyjna wykaszarka spalinowa
- GB Multi-function gasoline trimmer
- D Multifunktionales Motorsense
- RUS Многофункциональная мотокоса
- CZ Multifunkční benzínová sekačka
- RO Multifuncțională costitoare pe benzină
- H Multifunkciós motoros kasza
- E Segadora de combustión multiusos

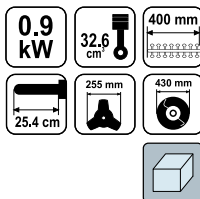

$L_{pA} = 92 \pm 3,0$ dB; $L_{wA} = 103 \pm 3,0$ dB; $a_n = 5,0 \pm 1,5$ m/s²

No.	kW	L (mm)	
79755	0.9	400	1

- PL Glowica żyłkowa
- GB Line head
- D Trimmerkopf
- RUS Головка с леской
- CZ Strunová hlava
- RO Cap cu cablu
- H Darnil fej
- E Cabezal de hilo

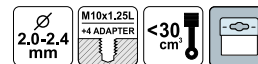

No.	Ø (mm)	
79550	2.0-2.4	10/40

- PL Glowica żyłkowa
- GB Line head
- D Trimmerkopf
- RUS Головка с леской
- CZ Strunová hlava
- RO Cap cu cablu
- H Darnil fej
- E Cabezal de hilo

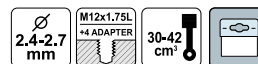

No.	Ø (mm)	
79551	2.4-2.7	10/40

- PL Glowica żyłkowa
- GB Line head
- D Trimmerkopf
- RUS Головка с леской
- CZ Strunová hlava
- RO Cap cu cablu
- H Darnil fej
- E Cabezal de hilo



No.	Ø (mm)	
79552	2.4-2.7	10/40

- PL Nóż do trawy
- GB Grass cutter blade
- D Rasenmesser
- RUS Нож для травы
- CZ Nůž OD WYQIN
- RO Cuțit pt. iarbă
- H Fűnyíró olló
- E Cuchilla para segar pasto



No.	for / dla	
79748	79747	50

- PL Klucz uniwersalny do narzędzi spalinowych
- GB Universal wrench for gasoline machines
- D Universalschlüssel für Benzin Maschinen
- RUS Универсальный ключ для бензинового инструмента
- CZ Univerzální klíč pro benzínové stroje
- RO Cheie universală pt. masini pe benzină
- H Kulccsal benzin eszköz
- E Llave universal para máquinas de gasolina



No.	
79869	20/160

- PL Podkaszarka elektryczna
- GB Electric grass trimmer
- D Elektrische Untergrasmähmaschine
- RUS Триммер электрический
- CZ Elektrická sekačka na trávu
- RO Cositoare pt. iarba
- H Elektromos fűnyíró
- E Segadora



230V~ 50Hz 250 W

14000 min⁻¹ 200mm



$L_{pa} = 82,3 \pm 3,0$ dB; $L_{wa} = 91,8 \pm 2,29$ dB; $a_n = 4,549 \pm 1,5$ m/s²

No.	W	min-1	Ø (mm)	
79456	250	14000	200	6/12

- PL Podkaszarka elektryczna
- GB Electric trimmer
- D Elektro-Rasentrimmer
- RUS Электрический триммер
- CZ Elektrická sekačka
- RO Cositoare electrică
- H Elektromos fűnyíró
- E Segadora eléctrica



230V~ 50Hz 500 W

10500 min⁻¹ 280mm

±100 cm ±80 cm 2 POSITIONS POZYCJE



$L_{pa} = 74,4 \pm 1,94$ dB; $L_{wa} = 94,1 \pm 1,94$ dB; $a_n = 0,794 \pm 1,5$ m/s²

No.	W	min-1	Ø (mm)	
79467	500	10500	280	4

- PL Głowica żyłkowa
- GB Line head
- D Trimmerkopf
- RUS Головка с леской
- CZ Strunová hlava
- RO Cap cu cablu
- H Damil fej
- E Cabezal de hilo



1.2 mm



No.	Ø (mm)	for / dla	
79468	1.2	79467	20/100

- PL Kosiarka spalinowa
- GB Gasoline lawn mower
- D Motorrasenmäher
- RUS Бензокосилка с контейнером
- CZ Motorová sekačka
- RO Masina tuns iarba pe gaz
- H Motoros fűnyíró
- E Podadora con motor de combustible



2.7 KM 3050 min⁻¹

140 cm³ 460 mm

±80 mm ±33 mm 46 cm

50 L GRASS BAG KOSZ NA TRAWIE 1.4 L



$L_{pa} = 86,2 \pm 3$ dB; $L_{wa} = 92,1 \pm 3$ dB; $a_n = 6 \pm 1,5$ m/s²

No.	KM	
79667	2.7	1

- PL Kosiarka spalinowa
- GB Gasoline lawn mower
- D Motorrasenmäher
- RUS Бензокосилка с контейнером
- CZ Motorová sekačka
- RO Masina tuns iarba pe gaz
- H Motoros fűnyíró
- E Podadora con motor de combustible



2.7 KM 3050 min⁻¹

140 cm³ 460 mm

±80 mm ±33 mm 46 cm

50 L GRASS BAG KOSZ NA TRAWIE 1.4 L



$L_{pa} = 86,2 \pm 3$ dB; $L_{wa} = 92,1 \pm 3$ dB; $a_n = 6 \pm 1,5$ m/s²

No.	KM	
79668	2.7	1

- PL Kosiarka spalinowa
- GB Gasoline lawn mower
- D Benzinrasenmäher
- RUS Бензокосилка с контейнером
- CZ Motorová sekačka
- RO Masina tuns iarba pe gaz
- H Motoros fűnyíró
- E Podadora con motor de combustible



4.0 KM 3050 min⁻¹

173 cm³ 510 mm

±90 mm ±30 mm 51 cm

55 L GRASS BAG KOSZ NA TRAWIE 1.2 L



$L_{pa} = 74,6 \pm 0,9$ dB; $L_{wa} = 94,0 \pm 1,05$ dB; $a_n = 6,0$ m/s²

No.	KM	
79672	4.0	1

PL Akumulatorowe nożyce do trawy i krzewów
 GB Cordless grass and shrub shears
 D Akkuschere mit Gras- und Strauchmesser
 RUS Аккумуляторные ножницы для травы и кустов
 CZ Akumulátorové nůžky s trávou a keřmi
 RO Trimmer cu acumulator pt. iarba si gard viu
 H Foarfecele cu acumulator pt. tăiat iarba
 E Tijeras a batería para hierba y arbustos

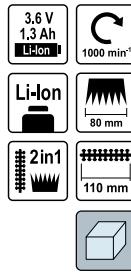

$L_{pa} = 74,6 \pm 3,0$ dB; $L_{wa} = 86,4 \pm 3,0$ dB; $a_n = 1,63 \pm 1,5$ m/s²

No.	min-1	Box
79500	1000	8

PL Akumulatorowe nożyce do trawy i krzewów
 GB Cordless grass and shrub shears
 D Akkuschere mit Gras- und Strauchmesser
 RUS Аккумуляторные ножницы для травы и кустов
 CZ Akumulátorové nůžky s trávou a keřmi
 RO Trimmer cu acumulator pt. iarba si gard viu
 H Foarfecele cu acumulator pt. tăiat iarba
 E Tijeras a batería para hierba y arbustos

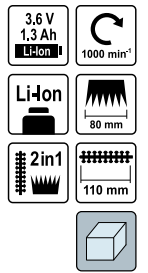

$L_{pa} = 74,6 \pm 3,0$ dB; $L_{wa} = 86,4 \pm 3,0$ dB; $a_n = 1,63 \pm 1,5$ m/s²

No.	min-1	Box
79501	1000	8

PL Nożyce do trawy wielopozycyjne
 GB Grass shears
 D Handgrassschere
 RUS Ножницы для стрижки травы

CZ Nůžky CDWYX
 RO Foarfece pt. gazon
 H Forgatható fűvyró olló
 E Tijeras de césped

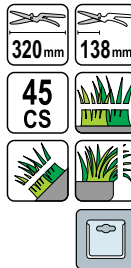

No.	L (mm)	Box
99300	320	12/48

PL Nożyce do trawy wielopozycyjne
 GB Grass shears
 D Handgrassschere
 RUS Ножницы для стрижки травы

CZ Nůžky CDWYX
 RO Foarfece pt. gazon
 H Forgatható fűvyró olló
 E Tijeras de césped

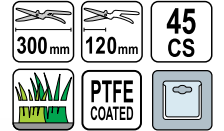

No.	L (mm)	Box
99301	300	12/48

PL Grabie wachlarzowe
 GB Spring rake
 D Landschaftsbesen
 RUS Грабли веерные

CZ Hrábičky
 RO Grebla de gradina
 H Kerti gereblye
 E Rastrillo de abanico de hojalata



No.	L (mm)	teeth / zęby	Box
35787	460	20	10

PL Grabie wachlarzowe
 GB Spring rake
 D Landschaftsbesen
 RUS Грабли веерные
 CZ Hrábičky
 RO Grebla de gradina
 H Kerti gereblye
 E Rastrillo de abanico de hojalata



No.	L (mm)	teeth / zęby	Box
35786	430	23	10

PL Grabie wachlarzowe
 GB Spring rake
 D Landschaftsbesen
 RUS Грабли веерные

CZ Hrábičky
 RO Grebla de gradina
 H Kerti gereblye
 E Rastrillo de abanico de hojalata



No.	L (mm)	teeth / zęby	Box
35790	435	20	20
35791	580	27	20



- PL Grabie wachlarzowe
GB Spring rake
D Landschaftsbesen
RUS Грабли веерные
- CZ Hraňičky
RO Grebla de gradina
H Kerti gereblye
E Rastrillo de abanico de hojalata



No.	L (mm)	teeth / zęby	
35785	435	23	12

- PL Grabie wachlarzowe metalowe
GB Metal fan rake
D Metall-Fächerbesen
RUS Грабли для уборки листьев металлические
CZ Kovové vějířové hrábě
RO Greblă evantai de metal
H Fém levelgereblye
E Rastrillo de abanico de metal

430 mm



No.	L (mm)	
99390	430	40

- PL Grabie wachlarzowe metalowe
GB Metal fan rake
D Metall-Fächerbesen
RUS Грабли для уборки листьев металлические
CZ Kovové vějířové hrábě
RO Greblă evantai de metal
H Fém levelgereblye
E Rastrillo de abanico de metal

460 mm



No.	L (mm)	
99391	460	50

- PL Grabie wachlarzowe metalowe
GB Metal fan rake
D Metall-Fächerbesen
RUS Грабли для уборки листьев металлические
CZ Kovové vějířové hrábě
RO Greblă evantai de metal
H Fém levelgereblye
E Rastrillo de abanico de metal

425 mm



No.	L (mm)	
99401	425	60

- PL Grabie wachlarzowe metalowe
GB Metal fan rake
D Metall-Fächerbesen
RUS Грабли для уборки листьев металлические
CZ Kovové vějířové hrábě
RO Greblă evantai de metal
H Fém levelgereblye
E Rastrillo de abanico de metal

530 mm



No.	L (mm)	
99400	530	24

- PL Grabie wachlarzowe
GB Spring rake
D Landschaftsbesen
RUS Грабли веерные
- CZ Hraňičky
RO Grebla de gradina
H Kerti gereblye
E Rastrillo de abanico de hojalata

120 cm



No.	L (mm)	working part width / szer. części roboczej (cm)	teeth / zęby	
35799	120	40	21	250

- PL Obrzeże trawnikowe, zielone
GB Lawn edge
D Gartenumrandung
RUS Оградка для огорода
- CZ Plastový okraj trávníku
RO Gărduț plastic grădină
H Agyásszegély
E Borde para jardín



No.	width / szerokość (mm)	L (m)	
88700	100	9	48
88701	150	9	36
88702	200	9	24

- PL Obrzeże trawnikowe, brązowe
GB Lawn edge
D Gartenumrandung
RUS Оградка для огорода
- CZ Plastový okraj trávníku
RO Gărduț plastic grădină
H Agyásszegély
E Borde para jardín



No.	width / szerokość (mm)	L (m)	
88703	100	9	48
88704	150	9	36
88705	200	9	24

PL Siatka zabezpieczająca rynny
GB Gutter mesh
D Schutzgitter für Rinnen
RUS Защитная сетка желоба

CZ Ochranná síť SURM DO ÁHQ RNDŠRYFK ÁDĚŮ
RO Plasă de protecție burlane
H Lombfogó háló
E Malla de protección para la canaleta

6m
18cm



No.	30
69850	30

PL Siatka zabezpieczająca rynny z uchwytami mocującymi
GB Gutter mesh with hooks
D Schutzgitter für Rinnen mit Spannvorrichtungen
RUS Защитная сетка желоба с монтажными ручками

CZ Ochranná síť SURM DO ÁHQ RNDŠRYFK ÁDĚŮ s úchytkami
RO Plasă de protecție burlane cu suporturi de protecție
H Lombfogó háló rögzítő fülelkel
E Malla de protección para la canaleta con mandriles de sujeción

6m
18cm

15x
HOOK
ZACZEP



No.	30
69851	30

PL Sito do kompostu i żwiru
GB Compost and gravel sieve
D Sieb für Kompost und Kies
RUS Сито для компоста и гравия
CZ Prohazovací sito na kompost a slátek
RO Cedazo para estiércol y guija
H Sită compost și zgură
E Rosta komposztáláshoz és sóderhez



No.	cm	size of eyelet / rozmiar oczka (mm)	30
34949	60x100	20	30

PL Aluminiowa drabina teleskopowa
GB Aluminium telescopic ladder
D Teleskopleiter aus Aluminium
RUS Алюминиевая телескопическая лестница
CZ + ODRNÉ NĚKĚRÉ VĚDMĚRSNĚ ÁĚETIK
RO Scară telescopică din aluminiu
H Alumínium kihúzható létra
E Escalera telescópica de aluminio

STEPS
STOPNE
x13

max
150
kg

AI NYLON

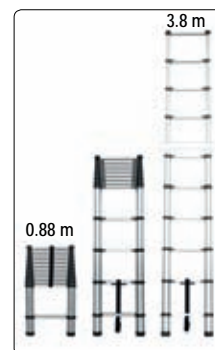

No.	1
17700	1

PL Aluminiowa drabina teleskopowa, przegubowa
GB Articulated aluminium telescopic ladder
D Teleskop-gelenkleiter aus Aluminium
RUS Алюминиевая шарнирная телескопическая лестница
CZ + ODRNÉ NĚKĚRÉ VĚDMĚRSNĚ ÁĚETIK
RO Scară telescopică din aluminiu cu articulații
H Alumínium kihúzható, csuklós létra
E Escalera telescópica de aluminio articulada

STEPS
STOPNE
2x6

max
150
kg

AI

NYLON

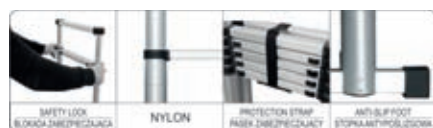
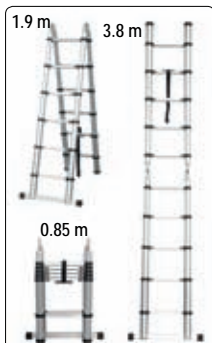

No.	1
17703	1

PL Akumulatorowe nożyce do trawy i krzewów
GB Cordless grass and shrub shears
D Akkuscherer mit Gras- und Strauchmesser
RUS Аккумуляторные ножницы для травы и кустов
CZ Akumulátorové nožnice na trávu a keře
RO Trimmer cu acumulator pt. iarbă și gard viu
H Foorfecele cu acumulator pt. tálat iarba
E Tijeras a batería para hierba y arbustos

3.6 V
1.3 Ah
Li-Ion

1000 min⁻¹

Li-Ion

80 mm

2in1
110 mm



No.	min-1	8
79500	1000	8

$L_{PA} = 74,6 \pm 3,0$ dB; $L_{WA} = 86,4 \pm 3,0$ dB; $a_s = 1,63 \pm 1,5$ m/s²

- PL Akumulatorowe nożyce do trawy i krzewów
 GB Cordless grass and shrub shears
 D Akkuschere mit Gras- und Strauchmesser
 RUS Аккумуляторные ножницы для травы и кустов
 CZ Akumulátorové nůžn. Sa trávy a keře
 RO Trimmer cu acumulator pt. iarba si gard viu
 H Foařecece cu acumulator pt. iariat iarba
 E Tijeras a batería para hierba y arbustos

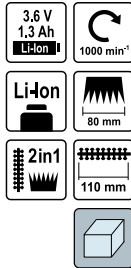

$L_{pa} = 74,6 \pm 3,0$ dB; $L_{wa} = 86,4 \pm 3,0$ dB; $a_n = 1,63 \pm 1,5$ m/s²



No.	min-1	Box
79501	1000	8

- PL Elektryczne nożyce do żywoplotu
 GB Hedge shears
 D Heckenscheren
 RUS Ножницы для живой изгороди
 CZ Nůžn. CD živé SĚV
 RO Foařece pt. gard viu
 H Sövényvágó olló
 E Tijera para vallado

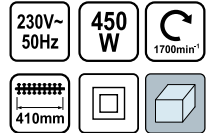

$L_{pa} = 81,6 \pm 3$ dB; $L_{wa} = 101,6 \pm 3$ dB; $a_n = 5,328 \pm 1,5 / 6,1214 \pm 1,5$ m/s²

No.	W	min-1	L (mm)	Box
79442	450	1700	410	4

- PL Nożyce do żywoplotu
 GB Hedge shears
 D Heckenscheren
 RUS Ножницы для живой изгороди
 CZ Nůžn. CD živé SĚV
 RO Foařece pt. gard viu
 H Sövényvágó olló
 E Tijera para vallado



$L_{pa} = 75,2 \pm 0,6$ dB; $L_{wa} = 95,2 \pm 0,6$ dB; $a_n = 2,840 \pm 1,5$ m/s²

No.	W	min-1	L (mm)	Box
79444	520	1600	510	4

- PL Nożyce do żywoplotu
 GB Hedge shears
 D Heckenscheren
 RUS Ножницы для живой изгороди
 CZ Nůžn. CD živé SĚV
 RO Foařece pt. gard viu
 H Sövényvágó olló
 E Tijera para vallado



$L_{pa} = 78,58 \pm 1,489$ dB; $L_{wa} = 98,54 \pm 1,489$ dB; $a_n = 3,272 \pm 1,5 / 3,435 \pm 1,5$ m/s²

No.	W	min-1	L (mm)	Box
79448	550	1700	510	4

- PL Nożyce do żywoplotu
 GB Hedge shears
 D Heckenscheren
 RUS Кусторезы
 CZ 1 Růžn. CD živé SĚV
 RO Foařece pt. gard viu
 H Sövényvágó olló
 E Tijeras para seto vivo



No.	L (mm)	Box
99006	630	12

- PL Nożyce do żywoplotu
 GB Hedge shears
 D Heckenscheren
 RUS Кусторезы
 CZ 1 Růžn. CD živé SĚV
 RO Foařece pt. gard viu
 H Sövényvágó olló
 E Tijeras para seto vivo



No.	L (mm)	Box
99005	535	24

PL Nożyce do żywoplotu
 GB Hedge shears
 D Heckenscheren
 RUS Кусторезы
 CZ 1 RÁCĚH CD ALÝE SĚW
 RO Foarfece pt. gard viu
 H Sövényvágó olló
 E Tijeras para seto vivo



No.	L (mm)	blade / ostrze L (mm)	
99007	590	185	18
99008	620	215	18

PL Nożyce do żywoplotu
 GB Hedge shears
 D Heckenscheren
 RUS Ножницы для живой изгороди
 CZ NůžAN CD ALÝE SĚW
 RO Foarfece pt. gard viu
 H Sövényvágó olló
 E Tijera para vallado

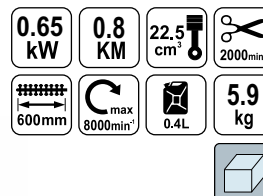

No.	kW	KM	min-1	L (mm)	
79722	0.65	0.8	8000	600	1

$L_{pa} = 84,5 \pm 1,3$ dB; $L_{wa} = 104,5 \pm 1,3$ dB; $a_n = 8,0 \pm 1,5$ m/s²

PL Nożyce do żywoplotu
 GB Hedge shears
 D Heckenscheren
 RUS Ножницы для живой изгороди
 CZ NůžAN CD ALÝE SĚW
 RO Foarfece pt. gard viu
 H Sövényvágó olló
 E Tijera para vallado



No.	kW	KM	min-1	L (mm)	
79723	0.9	1.2	8500	550	1

$L_{pa} = 91,84 \pm 1,09$ dB; $L_{wa} = 112,46 \pm 1,09$ dB; $a_n = 3,82 \pm 1,5$ m/s²

PL Nożyce do żywoplotu
 GB Hedge shears
 D Heckenscheren
 RUS Ножницы для живой изгороди
 CZ NůžAN CD ALÝE SĚW
 RO Foarfece pt. gard viu
 H Sövényvágó olló
 E Tijera para vallado

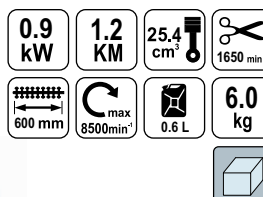

No.	kW	KM	min-1	L (mm)	
79724	0.9	1.2	8500	600	1

$L_{pa} = 87,45 \pm 3,26$ dB; $L_{wa} = 109,8 \pm 3,26$ dB; $a_n = 6,02 \pm 1,5$ m/s²

Garden tools & power tools / Narzędzia i elektronarzędzia ogrodowe

PL Sekator uniwersalny
GB By-pass pruner
D Rebenschere
RUS Секатор

CZ 1 R&QFH] DKUDG&Cke
RO Foarfece pt. pomi
H Metszooll&e
E Podadera universal

200
mm



No.	L (mm)	
99230	200	20/60

PL Sekator uniwersalny
GB By-pass pruner
D Rebenschere
RUS Секатор

CZ 1 R&QFH] DKUDG&Cke
RO Foarfece pt. pomi
H Metszooll&e
E Podadera universal

200
mm



65
Mn



PTFE
COATED





No.	L (mm)	
99190	200	18/72

PL Sekator uniwersalny
GB By-pass pruner
D Rebenschere
RUS Секатор

CZ 1 R&QFH] DKUDG&Cke
RO Foarfece pt. pomi
H Metszooll&e
E Podadera universal

180
mm



65
Mn



PTFE
COATED



No.	L (mm)	
99202	180	18/72

PL Sekator uniwersalny
GB By-pass pruner
D Rebenschere
RUS Секатор

CZ 1 R&QFH] DKUDG&Cke
RO Foarfece pt. pomi
H Metszooll&e
E Podadera universal

205
mm



65
Mn





No.	L (mm)	
99203	205	20/60

PL Sekator uniwersalny
GB By-pass pruner
D Rebenschere
RUS Секатор

CZ 1 R&QFH] DKUDG&Cke
RO Foarfece pt. pomi
H Metszooll&e
E Podadera universal

215
mm



65
Mn



LOWER
BLADE
PTFE
COATED



No.	L (mm)	
99204	215	20/60

PL Sekator uniwersalny
GB By-pass pruner
D Rebenschere
RUS Секатор

CZ 1 R&QFH] DKUDG&Cke
RO Foarfece pt. pomi
H Metszooll&e
E Podadera universal

200
mm



SK5



No.	L (mm)	
99208	200	12/60

PL Sekator uniwersalny
GB By-pass pruner
D Rebenschere
RUS Секатор

CZ 1 R&QFH] DKUDG&Cke
RO Foarfece pt. pomi
H Metszooll&e
E Podadera universal

215
mm



65
Mn





No.	L (mm)	
99209	215	6/48

PL Sekator kowadelkowy
GB Professional anvil pruner
D Amboss-Gartenschere
RUS Секатор

CZ 1 R&QFH] DKUDG&Cke
RO Foarfece pt. pomi
H Metszooll&e
E Podadera de bigornia

205
mm



65
Mn



PTFE
COATED



No.	L (mm)	
99207	205	20/60

PL Sekator kowadełkowy
GB Professional anvil pruner
D Amboss-Gartenschere
RUS Секатор

CZ 1 RáQFH] DKUDQFNH
RO Foarfece pt. pomi
H Metszoolló
E Podadera de bigornia

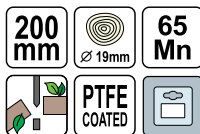

No.	L (mm)	
99191	200	18/72

PL Sekator wielofunkcyjny
GB Garden pocket pruner
D Rebenschere
RUS Секатор

CZ 1 RáQFH] DKUDQFNH
RO Foarfece pt. pomi
H Metszoolló
E Tijeras de podar



No.	L (mm)	
99210	200	12/48

PL Sekator do obcinania zawiązków
GB Fruit and flowers shears
D Blumen- und Rebenschere
RUS Секатор

CZ 1 RáQFH] DKUDQFNH
RO Foarfece pt. pomi
H Metszoolló
E Podadera para cortar germenos



No.	L (mm)	
99240	190	12/72

PL Sekator do gałęzi
GB By-pass lopping shears
D Astschere
RUS Сучкорез

CZ 1 RáQFH] DKUDQFNH
RO Foarfece curbata pt. taiat crengi
H Ágvágó fix
E Podadera para ramas

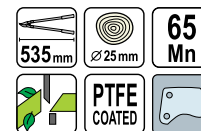

No.	L (mm)	
99103	535	12

PL Sekator do gałęzi
GB By-pass lopping shears
D Astschere
RUS Сучкорез

CZ 1 RáQFH] DKUDQFNH
RO Foarfece curbata pt. taiat crengi
H Ágvágó fix
E Podadera para ramas

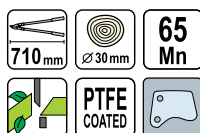

No.	L (mm)	
99109	710	10

PL Sekator do gałęzi
GB By-pass lopping shears
D Astschere
RUS Сучкорез
CZ 1 RáQFH] DKUDQFNH
RO Foarfece curbata pt. taiat crengi
H Ágvágó fix
E Podadera para ramas



No.	L (mm)	
99116	740	12

PL Sekator do gałęzi
GB By-pass lopping shears
D Astschere
RUS Сучкорез
CZ 1 RáQFH] DKUDQFNH
RO Foarfece curbata pt. taiat crengi
H Ágvágó fix
E Podadera para ramas



No.	L (mm)	
99111	750	12

PL Sekator do gałęzi
GB Anvil lopping shears
D Astschere
RUS Сучкорез с храповым механизмом
CZ 1 RáQFH] DKUDQFNH CD KXEP NRQ UH
RO Foarfece curbata pt. taiat crengi
H Ágvágó fix
E Podadera para ramas con carraca

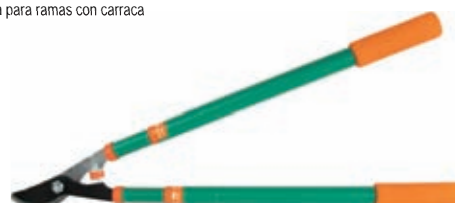
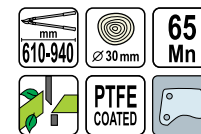

No.	L (mm)	
99115	610-940	12

PL Sekator do gałęzi
 GB Anvil lopping shears
 D Astschere
 RUS Сучкорез с храповым механизмом
 CZ 1 Ráďeň | DKUDQJFNH CD KXEř NRQ UH
 RO Foarfeca curbata pt. taiat crengi
 H Ágvágó fix
 E Podadera para ramas con carraca

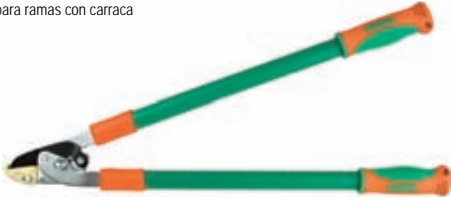

No.	L (mm)	
99110	710	12

PL Sekator do gałęzi
 GB Anvil lopping shears
 D Astschere
 RUS Сучкорез с храповым механизмом
 CZ 1 Ráďeň | DKUDQJFNH CD KXEř NRQ UH
 RO Foarfeca curbata pt. taiat crengi
 H Ágvágó fix
 E Podadera para ramas con carraca

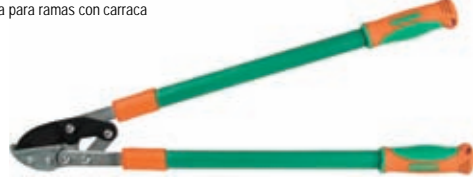

No.	L (mm)	
99112	735	12

PL Sekator gašlenicowy z piłã
 GB Leverage tree pruner
 D Baumsãge mit astschere
 RUS Сучкорез штанговый с пилой

CZ Sřiřãč na vĕtvĕ s pilovým listem
 RO Fierastrãu pt. pomi cu prelungitor
 H Kõteles ágvágó
 E Podadera de palanca con sierra

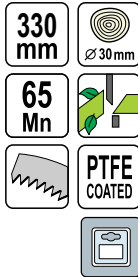

No.	L (mm)	
99310	330	12/24

PL Przedłużka teleskopowa
 GB Telescopic handle
 D Teleskopstange
 RUS Ружьятка телескопическая

CZ 7HBMRSIENĚ SURCQARNDĚ
 RO Prelungitor telescopic
 H Teleszkõpos hosszabbító
 E Tubo de prolongación telescõpico

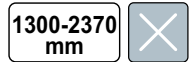

No.	L (mm)	
99315	1300-2370	12

PL Pila kabiãkowa
 GB Bow saw
 D Bũgelsãge
 RUS Лучковая пила

CZ Obloukovã pila
 RO Ferãstrãu de curburã
 H Keretes fũrész
 E Sierra de arco

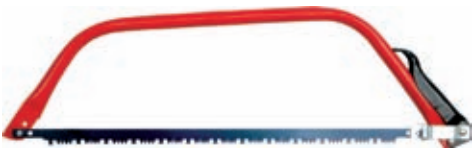

No.	L (mm)	
28740	515	24
28750	735	24

PL Pila kabiãkowa
 GB Bow saw
 D Bũgelsãge
 RUS Лучковая пила

CZ Obloukovã pila
 RO Ferãstrãu de curburã
 H Keretes fũrész
 E Sierra de arco



No.	L (mm)	
28745	530	12/24

PL Pila kabiãkowa
 GB Bow saw
 D Bũgelsãge
 RUS Лучковая пила

CZ Obloukovã pila
 RO Ferãstrãu de curburã
 H Keretes fũrész
 E Sierra de arco



No.	L (mm)	
28746	610	12/24
28755	760	12/24
28757	900	12/24

PL Brzeczscot
 GB Spare blade for bow saw
 D Bũgelsãgeblatt
 RUS Полотно д/пилы „Лидер”

CZ Ostřil na dřevõ
 RO Panza fierãstrãu tip arc
 H Fũrészlap fãhoz
 E Hoja de sierra

WET WOOD

DREWNO MOKRE



No.	L (mm)	W (mm)	
28771	530	20	60/240
28772	610	20	60/240
28773	760	20	60/240
28775	900	20	60/240

PL Pila ogrodnicza - lisi ogon
GB Pruning saw
D Baumsäge
RUS Пила садовая

CZ Zahradnická pila - liščí ocas
RO Fierăstrău de grădină-coadă de vulpe
H Gallyazófűrész-roka farkú
E Sierra de jardín - cola de zorro

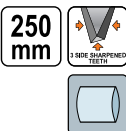

No.	L (mm)	
28640	250	12/120

PL Pila do gałęzi składana
GB Pruning saw
D Baumsäge
RUS Пила садовая

CZ Zahradnická pila
RO Fierăstrău pt. perforare
H Gallyazófűrész
E Sierra para ramos plegable

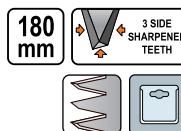

No.	L (mm)	
28641	180	20/60

PL Pila do gałęzi z kaburą
GB Pruning saw
D Baumsäge
RUS Пила садовая

CZ Zahradnická pila
RO Fierăstrău pt. perforare
H Vermorel
E Sierra de jadin

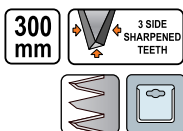

No.	L (mm)	
28642	300	12/36

PL Spryskiwacz ciśnieniowy ręczny
GB Pressure sprayer
D Drucksprüher
RUS Ручной опрыскиватель

CZ Ruční tlakový postřikovač
RO Vermorel
H Permetező kézi
E Rocíador de presión, de mano



No.	l	
89507	1.0	20
89508	1.5	15
89509	2.0	15

PL Opryskiwacz ciśnieniowy
GB Pressure sprayer
D Drucksprüher
RUS Ручной давятельный опрыскиватель
CZ Ruční tlakový postřikovač
RO Pulverizator de mana
H Permetező kézi
E Rocíador de presión

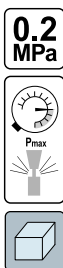

No.	l	
89515	5.0	6
89518	8.0	6

PL Opryskiwacz ciśnieniowy
GB Pressure sprayer
D Drucksprüher
RUS Ручной давятельный опрыскиватель
CZ Ruční tlakový postřikovač
RO Pulverizator de mana
H Permetező kézi
E Rocíador de presión



No.	l	
89520	8.0	6

- PL Opryskiwacz ciśnieniowy plecakowy
- GB Pressure sprayer
- D Rücken-Drucksprüher
- RUS Опрыскиватель ранцевый
- CZ Tlakový postřikovač zádový
- RO Pulverizator portabil
- H Permetező háti
- E Roclador de presión tipo „mochila”



P_{max}

0.2 MPa



No.	l	
89525	15.0	1

- PL Opryskiwacz ciśnieniowy plecakowy
- GB Pressure sprayer
- D Rücken-Drucksprüher
- RUS Опрыскиватель ранцевый
- CZ Tlakový postřikovač zádový
- RO Pulverizator portabil
- H Permetező háti
- E Roclador de presión tipo „mochila”



0.2 MPa

P_{max}



No.	l	
89526	15.0	1
89528	20.0	1

- PL Dyfuzyjny opryskiwacz spaliny
- GB Diffusion gasoline sprinker
- D Ruckenspritze mit Verbrennungsmotor
- RUS Диффузионный бензиновый опрыскиватель
- CZ Motorový zádový postřikovač
- RO Dispozitiv pt. stropit cu combustibil purtat in spate
- H Robbanómotoros háti permetezőgé
- E Roclador de combustión de mochila



2.13 kW
2.9 KM

41.5 cm³

12 m max

≥ 3 l/min



$L_{pa} = 78.8 \pm 3.0 / 97.8 \pm 3.0$ dB;
 $L_{wa} = 89.8 \pm 3.0 / 108.8 \pm 3.0$ dB; $a_n = 1.94 \pm 1.5 / 8.93$ 78,8 ± 1,5 m/s²

No.	l	kW	KM	
89600	16.0	2.13	2.9	1
89601	20.0	2.13	2.9	1

- PL Pilarka spalinywa
- GB Gasoline sawing machine
- D Motor-Kettensäge
- RUS Бензиновая пила
- CZ Benzínová pila
- RO Drujbă pe combustibil
- H Motoros fűrés
- E Sierra de combustión interna



1.8 kW
2.4 KM

45 cm³
1100 min⁻¹

1.5 mm

7T
.325

OIL TANK
0.26 l

AUTOMATIC CHAIN LUBRICATION
AUTOMATYCZNE SMAROWANIE UKŁADU TĄCZĄCO

ANTIVIBRATION SYSTEM
SYSTEM ANTYWIBRACYJNY



$L_{pa} = 90.8 \pm 2.5$ dB; $L_{wa} = 109.3 \pm 2.5$ dB; $a_n = 6.815 \pm 1.5 / 5.277 \pm 1.5$ m/s²

No.	kW	KM	L (mm)	
79835	1.8	2.4	440	1

- PL Pilnik okrągły do łańcuchów
- GB Chain saw file
- D Runde Kettenfelle
- RUS Цилиндрический напильник для цепей
- CZ Kulatý pilník na řetězy
- RO Piliă rotundă pt. lanțuri
- H Láncvágó körfűrész
- E Lima redonda para cadenas



200 mm T15



No.	L (mm)	Ø (mm)	pcs / packing	
79861	200	4.0	4	200
79862	200	4.5	4	200
79863	200	4.8	4	200

- PL Prowadnik do pilnika do łańcuchów
- GB Guide for chain saw file
- D Führung für die Kettenfelle
- RUS Направляющая для напильника для цепей
- CZ Vedení pro pilník na řetězy
- RO Ghidaj pt. pila pt. lanțuri
- H Megvezető a láncfűrészhez
- E Guia de lima para cadenas



No.	chain pitch / podziałka łańcucha	Ø (mm)	
79865	3/8 picco	4.0	50/150
79866	microlite	4.5	50/150
79867	.325	4.8	50/150

PL Siekiera ze stali kutej
 GB Drop forged hatchet
 D Handbell
 RUS Топор стальной кованый

CZ Sekera ocelová kovaná
 RO Toporisca lama forjată
 H Kovácsolt acél fejsze
 E Hacha de metalo forjado



No.	kg	
33080	0.8	12/24

PL Siekiera
 GB Axe
 D Handbell
 RUS Топор

CZ Sekyřka
 RO Toporisca
 H Szeķerce
 E Hacha



No.	g	
33067	600	24
33087	800	20
33107	1000	12
33127	1250	12
33147	1400	12
33177	1600	12

PL Siekiera
 GB Axe
 D Handbell
 RUS Топор

CZ Sekyřka
 RO Toporisca
 H Szeķerce
 E Hacha



No.	kg	
32930	1.0	10

PL Siekiera, rączka z włókna szklanego
 GB Axe with fiberglass + PVC handle
 D Handbell fiberglassstiel
 RUS Топор строительный с фиберглассовой ручкой

CZ Sekyřka
 RO Toporisca cu coada din fibra de sticla
 H Szeķerce
 E Hacha con mango de fibra de vidrio



No.	g	
33065	600	20
33085	800	20
33105	1000	12
33125	1250	6

PL Siekiera
 GB Axe
 D Handbell
 RUS Топор

CZ Sekyřka
 RO Toporisca
 H Szeķerce
 E Hacha



No.	kg	
33024	0.4	5
33026	0.6	5
33028	0.8	5
33030	1.0	5
33032	1.25	5
33035	1.50	5
33038	1.80	5
33039	2.0	5
33040	2.50	5

PL Siekiera
 GB Axe
 D Handbell
 RUS Топор

CZ Sekyřka
 RO Toporisca
 H Szeķerce
 E Hacha



No.	kg	
33000	0.4	5
33001	0.6	5
33002	0.8	5
33003	1.0	5
33004	1.25	5
33005	1.50	5
33006	1.80	5
33007	2.0	5
33008	2.50	5

PL Siekiera z klinem
GB Axe
D Handbell
RUS Топор

CZ Sekyrka
RO Toporişca
H Szekerce
E Hacha



No.	kg	
32924	2	5

PL Siekierno-mot
GB Hammer-axe for wood splitting
D Spaltaxt
RUS Топор-колун

CZ Sekera-kladivo
RO Secure-clocan
H Szekerce-kalapács
E Hacha martillo para partir madera



No.	kg	
32925	2.5	1
32926	4.0	1

PL Siekiera kanadyjska
GB Canadian axe
D Handbell „Kanadische Form“
RUS Топор тип канадский

CZ Sekera kanadská
RO Topor canadian
H Hosszú nyelű, hasztó fejsze
E Hacha canada

1.8 kg



No.	kg	
33022	1.8	5

PL Klin do rozłupywania drewna
GB Wood splitter
D Spaltkeil
RUS Клиn для раскалывания бревен

CZ Klin na štípání polen
RO Pana pt. lemn
H Fahasító ék
E Cuña para partir madera



No.	kg	
32922	2	1
32923	3	1

PL Łopatka
GB Trowel
D Blumenkelle
RUS Совок посадочный
CZ Lopatka
RO Mini-lopata gradinarit
H Ásó
E Paleta ancha

320 mm



No.	L (mm)	
35765	320	50

PL Łopatka
GB Trowel
D Blumenkelle
RUS Совок посадочный
CZ Lopatka
RO Mini-lopata gradinarit
H Ásó
E Paleta ancha

305 mm



No.	L (mm)	
99012	305	12/72

PL Łopatka
GB Trowel
D Blumenkelle
RUS Совок посадочный
CZ Lopatka
RO Mini-lopata gradinarit
H Ásó
E Paleta ancha

435 mm



No.	L (mm)	
99020	435	12/72

PL Łopatka
GB Trowel
D Blumenkelle
RUS Совок посадочный
CZ Lopatka
RO Mini-lopata gradinarit
H Ásó
E Paleta ancha

350 mm



No.	L (mm)	
99048	350	25/100

PL Łopátka
GB Trowel
D Blumenkelle
RUS Сокoв посадочный
CZ Lopátka
RO Mini-lopata gradinarit
H Ásó
E Paleta ancha

350 mm



No.	L (mm)	
99047	350	25/100

PL Łopátka
GB Trowel
D Blumenkelle
RUS Сокoв посадочный
CZ Lopátka
RO Mini-lopata gradinarit
H Ásó
E Paleta ancha

305 mm



No.	L (mm)	
99011	305	12/72

PL Łopátka do korzeni
GB Weeding trowel
D Wurzelstecher
RUS Лопатка для
корней растений

CZ Lopátka na kořeny rostlin
RO Lopata pt. buruien
H Kerti űteltő
E Paleta

490 mm



No.	L (mm)	
99027	490	12/72

PL Saperka wielofunkcyjna
GB Multifunctional shovel
D Kombi-faltschaufel
RUS Сапёрная лопата многофункциональная
CZ Lopátka víceúčelová
RO Lopata multifunctionala
H Többfunkciós ásó
E Zapadora multifuncion



No.		
99053		36

PL Saperka składana
GB Folding shovel
D Fallschaufel
RUS Сапёрная лопата
складная

CZ Lopátka skládací
RO Lopata demontabila
H Őszecsukható ásó
E Zapadora desmontable



No.		
99054		36

PL Grabki
GB Rake
D Kleinrechen
RUS Грабли

CZ Hraňčky
RO Mini grebla
H Gereblye
E Rastrillo

365 mm



No.	L (mm)	
99024	365	12/72

PL Grabki
GB Rake
D Kleinrechen
RUS Грабли

CZ Hraňčky
RO Mini grebla
H Gereblye
E Rastrillo

300 mm



No.	L (mm)	
99051	300	25/100

PL Grabki wachlarzowe
GB Garden rake
D Landschaftsbesen
RUS Грабли веерные

CZ Hraňčky
RO Grebla de gradina
H Kerti gereblye
E Rastrillo de abanico de hojalata

505 mm



No.	L (mm)	
99025	505	12/72

PL Motyczka z pazurkami
GB Hoe + cultivator
D Kleinhacke
RUS Рыхлитель комбинированный

CZ Motyčka s hrabičkami
RO Sapaliga + cultivator
H Kerti villás kapa
E Azadilla con escarificador

370 mm



No.	L (mm)	
99021	370	12/72

PL Motyczka z pazurkami
GB Hoe + cultivator
D Kleinhacke
RUS Рыхлитель комбинированный

CZ Motyčka s hrabičkami
RO Sapaliga + cultivator
H Kerti villás kapa
E Azadilla con escarificador

300 mm



No.	L (mm)	
99050	300	50

PL Motyczka
GB Hoe
D Garten handhacke
RUS Мотыжка

CZ Motyčka
RO Săpăligă
H Kerti kapa
E Azadilla

350 mm



No.	L (mm)	
35768	350	50

PL Motyczka
GB Hoe
D Garten handhacke
RUS Мотыжка

CZ Motyčka
RO Săpăligă
H Kerti kapa
E Azadilla

300 mm



No.	L (mm)	
99052	300	25/100

PL Pazurki
GB Cultivator
D Grubber
RUS Рыхлитель садовый

CZ Kultivátor
RO Cultivator
H Kultivátor
E Escarificador

330 mm



No.	L (mm)	
35767	330	50

PL Pazurki
GB Cultivator
D Grubber
RUS Рыхлитель садовый

CZ Kultivátor
RO Cultivator
H Kultivátor
E Escarificador

310 mm



No.	L (mm)	
99049	310	25/100

PL Pazurki
GB Cultivator
D Grubber
RUS Рыхлитель садовый

CZ Kultivátor
RO Cultivator
H Kultivátor
E Escarificador

255 mm



No.	L (mm)	
99013	255	12/72

PL Pazurki opravione
GB Cultivator
D Grubber
RUS Рыхлитель садовый

CZ Kultivátor
RO Cultivator
H Kultivátor
E Escarificador

425 mm



No.	L (mm)	
99023	425	12/72

- PL Obcinacz obrzeży trawnika
 GB Patio weeder
 D Rasenkanntenstecher
 RUS Садовый нож для обработки краев газона
 CZ Nůž na okraj trávníku
 RO Cutiți pt. talat gazonul
 H Pázsitzegély vágó
 E Cortador de reborde de cesped

445
mm



No.	L (mm)	☐
99026	445	12/72

- PL Komplet narzędzi ogrodowych
 GB Garden tool set
 D Garten-Kleingerätesatz
 RUS Набор садово-огородного инструмента

- CZ Sada zahradnického náčiní
 RO Set pt. grădiniării
 H Kertész készlet
 E Juego de herramientas de jardín

3
PCS



No.	L (mm)	☐
99028	205	50

- PL Komplet narzędzi ogrodowych
 GB Garden tool set
 D Garten-Kleingerätesatz
 RUS Набор садово-огородного инструмента

- CZ Sada zahradnického náčiní
 RO Set pt. grădiniării
 H Kertész készlet
 E Juego de herramientas de jardín

7
PCS



No.	pcs	☐
99041	7	12

- PL Komplet narzędzi ogrodowych
 GB Garden tool set
 D Garten-Kleingeräte-set
 RUS Набор садово-огородного инструмента

- CZ Sada zahradnického náčiní
 RO Set pt. grădiniării
 H Kertész készlet
 E Juego de herramientas de jardín

3
PCS



No.	pcs	☐
99055	3	12/48

- PL Sadzarka do cebuli
 GB Bulb planter
 D Blumenzwiebelplanzer
 RUS Конус посадочный для рассады
 CZ Sázeč
 RO Plantator
 H Palántázó
 E Plantadora para cebollas



No.	☐
99033	10/60

- PL Opryskiwacz ciśnieniowy
 GB Pressure sprayer
 D Drucksprüher
 RUS Ручной давятельный опрыскиватель
 CZ Ruční tlakový postřikovač
 RO Pulverizator de mana
 H Permetező kézi
 E Rocciador de presión

0.2
MPa

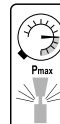

No.	l	☐
89515	5.0	6
89518	8.0	6

- PL Spryskiwacz ciśnieniowy ręczny
 GB Pressure sprayer
 D Drucksprüher
 RUS Ручной опрыскиватель
 CZ Ruční tlakový postřikovač
 RO Vermorel
 H Permetező kézi
 E Rocciador de presión, de mano



No.	l	☐
89507	1.0	20
89508	1.5	15
89509	2.0	15

- PL Opryskiwacz ciśnieniowy
 GB Pressure sprayer
 D Drucksprüher
 RUS Ручной давятельный опрыскиватель
 CZ Ruční tlakový postřikovač
 RO Pulverizator de mana
 H Permetező kézi
 E Rocelador de presión



8L

0.2 MPa

MANOMETER

P_{max}



No.	l	
89520	8.0	6

- PL Opryskiwacz ciśnieniowy plecakowy
 GB Pressure sprayer
 D Rücken-Drucksprüher
 RUS Опрыскиватель ранцевый

- CZ Tlakový postřikovač zádový
 RO Pulverizator portabil
 H Permetező hátí
 E Rocelador de presión tipo „mochila”



0.2 MPa

MANOMETER

P_{max}



No.	l	
89525	15.0	1

- PL Opryskiwacz ciśnieniowy plecakowy
 GB Pressure sprayer
 D Rücken-Drucksprüher
 RUS Опрыскиватель ранцевый

- CZ Tlakový postřikovač zádový
 RO Pulverizator portabil
 H Permetező hátí
 E Rocelador de presión tipo „mochila”

0.2 MPa

MANOMETER

P_{max}



No.	l	
89526	15.0	1
89528	20.0	1

- PL Dyfuzyjny opryskiwacz spalinowy
 GB Diffusion gasoline sprinker
 D Ruckenspritze mit Verbrennungsmotor

- RUS Диффузионный бензиновый опрыскиватель
 CZ Motorový zádový postřikovač
 RO Dispozitiv pt. stropit cu combustibil purtat in spate
 H Robbanómotoros hátí permetezőgép
 E Rocelador de combustión de mochila

2.13 kW

41.5 cm³

2.9 KM

12 m max

≥3 l/min



$L_{wa} = 78.8 \pm 3.0 / 97.8 \pm 3.0$ dB;
 $L_{wA} = 89.8 \pm 3.0 / 108.8 \pm 3.0$ dB; $a_w = 1.94 \pm 1.5 / 8.93$ 78.8 \pm 1.5 m/s²

No.	l	kW	KM	
89600	16.0	2.13	2.9	1
89601	20.0	2.13	2.9	1

- PL Pila kabłąkowa
 GB Bow saw
 D Bügelsäge
 RUS Лучковая пила

- CZ Oblouková píla
 RO Ferăstrău de curbură
 H Keretes fűrész
 E Sierra de arco



No.	L (mm)	
28740	515	24
28750	735	24

- PL Pila kabłąkowa
 GB Bow saw
 D Bügelsäge
 RUS Лучковая пила

- CZ Oblouková píla
 RO Ferăstrău de curbură
 H Keretes fűrész
 E Sierra de arco



No.	L (mm)	
28746	610	12/24
28755	760	12/24
28757	900	12/24

PL Pila kabłąkowa
GB Bow saw
D Bügelsäge
RUS Лучковая пила

CZ Oblouková pila
RO Ferăstrău de curbură
H Keretes fűrész
E Sierra de arco



No.	L (mm)	
28745	530	12/24

PL Brzeczczot
GB Spare blade for bow saw
D Bügelsägeblatt
RUS Полотно для пилы „Лидер”

CZ Ostří na dřevo
RO Panza fierastrau tip arc
H Fűrészlap fához
E Hoja de sierra

WET WOOD

DREWNO MOKRE



No.	L (mm)	W (mm)	
28771	530	20	60/240
28772	610	20	60/240
28773	760	20	60/240
28775	900	20	60/240

PL Pila ogrodnicza - lisi ogon
GB Pruning saw
D Baumsäge
RUS Пила садовая

CZ Zahradnická pila - liščí ocas
RO Fierăstrău de grădină-coadă de vulpe
H Gallyazófűrész-róka farkú
E Sierra de jardín - cola de zorro

250 mm



No.	L (mm)	
28640	250	12/120

PL Pila do gałęzi składana
GB Pruning saw
D Baumsäge
RUS Пила садовая

CZ Zahradnická pila
RO Fierăstrău pt. perforare
H Gallyazófűrész
E Sierra para ramos plegable

180 mm



No.	L (mm)	
28641	180	20/60

PL Pila do gałęzi z kaburą
GB Pruning saw
D Baumsäge
RUS Пила садовая

CZ Zahradnická pila
RO Fierăstrău pt. perforare
H Gallyazófűrész
E Sierra de jardín

300 mm



No.	L (mm)	
28642	300	12/36

PL Świder ręczny do gleby
GB Gimlet to the soil
D Handbohrer für den Erdboden
RUS Ручной почвенный бур

CZ Ruční vrták do půdy
RO Sfredel manual pt. pământ
H Kézi talajfúró
E Taladro manual para suelo



No.	Ø (mm)	L (m)	
35670	170	15	50
35671	250	15	24

PL Szpadel
GB Spade
D Rodespaten
RUS Заступ

CZ Lisovaný ryč kalená
RO Hârleț cu coadă
H Ásó, sajtolt-edzett
E Pala

T



No.	type	
35800	T	140

PL Szpadel
GB Spade
D Rodespaten
RUS Заступ

CZ Lisovaný ryč kalená
RO Hârleț cu coadă
H Ásó, sajtolt-edzett
E Pala

T



No.	type	
35802	T	140

PL Szpadel
GB Spade
D Rodespaten
RUS Засу́н

CZ Lisovaný ryč kalená
RO Hârleţ cu coadă
H Ásó, sajtolt-edzett
E Pala



No.	type	
35801	T	140

PL Szpadel
GB Spade
D Rodespaten
RUS Засу́н

CZ Lisovaný ryč kalená
RO Hârleţ cu coadă
H Ásó, sajtolt-edzett
E Pala



No.	type	
35803	DY	140

PL Szpadel
GB Spade
D Rodespaten
RUS Засу́н

CZ Lisovaný ryč kalená
RO Hârleţ cu coadă
H Ásó, sajtolt-edzett
E Pala



No.	type	
35805	DY	140

PL Szpadel
GB Spade
D Rodespaten
RUS Засу́н

CZ Lisovaný ryč kalená
RO Hârleţ cu coadă
H Ásó, sajtolt-edzett
E Pala



No.	type	
35809	DY	250

PL Szpadel
GB Spade
D Rodespaten
RUS Засу́н

CZ Lisovaný ryč kalená
RO Hârleţ cu coadă
H Ásó, sajtolt-edzett
E Pala



No.	type	
35806	DY	140

PL Szpadel
GB Spade
D Rodespaten
RUS Засу́н

CZ Lisovaný ryč kalená
RO Hârleţ cu coadă
H Ásó, sajtolt-edzett
E Pala



No.	type	
35810	DY	250

PL Szpadel drenarski, nitowany
GB Riveted drainage spade
D Drainagespaten, genietet
RUS Лопата дренажная сборная

CZ Ryč GHI aQ QAVYDCE
RO Sapă drenaj nitul
H Szegecsett drénező ásó
E Pala de drenaje remachada



No.	type	
35807	T	140

PL Szpadel drenarski, profilowany
GB Roll formed drainage spade
D Drainagespaten, profilert
RUS Лопата дренажная цельноштампованная

CZ Ryč GHI aQ SURILOVANÝ
RO Sapă drenaj profilată
H Profilozott drénező ásó
E Pala de drenaje perfilada



No.	type	
35808	DY	140

PL Łopata piaskowa
GB Shovel
D Schaufel
RUS Лопата совковая песочная

CZ Osazený ryč pískový
RO Lopată pt. nisip
H Homoklapát
E Pala arena



No.	type	
35839	DY	120

PL Łopata piaskowa
GB Shovel
D Schaufel
RUS Лопата совковая песочная

CZ Osazený ryč pískový
RO Lopată pt. nisip
H Homoklapát
E Pala arena



No.	type	
35840	T	200

PL Łopata piaskowa
GB Shovel
D Schaufel
RUS Лопата совковая песочная

CZ Osazený ryč pískový
RO Lopată pt. nisip
H Homoklapát
E Pala arena



No.	type	
35843	DY	120

PL Łopata piaskowa - zwirowa
GB Shovel
D Schaufel
RUS Лопата совковая песочная

CZ Osazený ryč pískový
RO Lopată pt. nisip
H Homoklapát
E Pala arena



No.	type	
35861	DY	120

PL Łopata
GB Shovel
D Kohlschaufel
RUS Лопата

CZ Lopata
RO Lopată
H Homoklapát
E Pala



No.	type	
35846	DY	250

PL Łopata węglowa
GB Shovel
D Kohlschaufel
RUS Лопата угольная

CZ Úhlový ryč čisto
RO Lopată pt. cărbune
H Szénslapát
E Pala carbón



No.	type	
35850	T	120

PL Łopata węglowa
GB Shovel
D Kohlschaufel
RUS Лопата угольная

CZ Úhlový ryč čisto
RO Lopată pt. cărbune
H Szénslapát
E Pala carbón



No.	type	
35860	DY	90

PL Łopata węglowa
GB Shovel
D Kohlschaufel
RUS Лопата угольная

CZ Úhlový ryč čisto
RO Lopată pt. cărbune
H Szénslapát
E Pala carbón



No.	type	
35863	DY	120

PL Łopata piaskowa
GB Shovel
D Schaufel
RUS Лопата совковая песочная

CZ Osazený ryč pískový
RO Lopată pt. nisip
H Homoklapát
E Pala arena

135 cm P



No.	L (cm)	type	
35842	135	P	100

PL Widły
GB Digging fork
D Grabegabel
RUS Вилы свекловичные кованые

CZ Zahradnické vidlice
RO Furcă pt. grădină
H Vasvilla
E Horca

P



No.	teeth / zęby	type	
35815	3	P	1
35816	4	P	1

PL Widły
GB Digging fork
D Grabegabel
RUS Вилы свекловичные кованые

CZ Zahradnické vidlice
RO Furcă pt. grădină
H Vasvilla
E Horca

T



No.	teeth / zęby	type	
35865	4	T	140

PL Widły
GB Digging fork
D Grabegabel
RUS Вилы свекловичные кованые

CZ Zahradnické vidlice
RO Furcă pt. grădină
H Vasvilla
E Horca

DY



No.	type	
35817	DY	250

PL Widły
GB Digging fork
D Grabegabel
RUS Вилы свекловичные кованые

CZ Zahradnické vidlice
RO Furcă pt. grădină
H Vasvilla
E Horca

DY



No.	teeth / zęby	type	
35866	4	DY	140

PL Widły
GB Digging fork
D Grabegabel
RUS Вилы свекловичные кованые

CZ Zahradnické vidlice
RO Furcă pt. grădină
H Vasvilla
E Horca

DY



No.	teeth / zęby	type	
35812	3	DY	100
35813	4	DY	100

PL Widły
GB Digging fork
D Grabegabel
RUS Вилы свекловичные кованые

CZ Zahradnické vidlice
RO Furcă pt. grădină
H Vasvilla
E Horca

DY



No.	teeth / zęby	type	
35864	4	DY	140

PL Pazurki oprawione
GB Cultivator
D Grubber
RUS Рыхлитель садовый

CZ Kultivátor
RO Cultivator
H Kultivátor
E Escarificador

125 cm P



No.	L (cm)	type	
35763	125	P	5

PL Grabie CZ Hrábě
GB Rake RO Greblă
D Rechen H Gereblye
RUS Грабли E Rastrillo



No.	L (cm)	teeth / zęby	type	
35781	122	10	P	10
35782	114	12	P	10
35784	132	14	P	10
35783	114	16	P	10

PL Grabie CZ Hrábě
GB Rake RO Greblă
D Rechen H Gereblye
RUS Грабли E Rastrillo



No.	L (cm)	teeth / zęby	type	
35756	130	10	P	250
35757	130	12	P	250
35758	130	14	P	250
35759	130	16	P	250

PL Grabie CZ Hrábě
GB Rake RO Greblă
D Rechen H Gereblye
RUS Грабли E Rastrillo



No.	L (cm)	teeth / zęby	
35779	150	12	150
35780	150	16	140

PL Grabie plastikowe CZ Plastové hrábě
GB Plastic rake RO Greblă de plastic
D Plasteharken H Műanyag gereblye
RUS Грабли пластиковые E Rastrillo de plástico



No.	L (mm)	teeth / zęby	
35788	550	16	10
35789	600	18	10

PL Wertykulator do trawy CZ Kultivátor oboustranný
GB Grass cultivator RO Cultivator
D Schneidrechen H Kétoldalas talajlazító, gyephez
RUS Грабли аэрационные E Cultivador de dos lados



No.	L (mm)	
35700	380	5/10

PL Grabie CZ Hrábě
GB Rake RO Greblă
D Rechen H Gereblye
RUS Грабли E Rastrillo



No.	L (mm)	teeth / zęby	
35750	270	12	48
35751	340	14	28

PL Grabie CZ Hrábě
GB Rake RO Greblă
D Rechen H Gereblye
RUS Грабли E Rastrillo



No.	L (mm)	teeth / zęby	
35755	360	14	20

PL Pazurki CZ Kultivátor
GB Cultivator RO Cultivator
D Grubber H Kultivátor
RUS Рыхлитель садовый E Escarificador



No.	L (mm)	
35793	100	60
35794	130	60

PL Motyczka z pazurkami
GB Hoe + cultivator
D Kleinhacke
RUS Рыхлитель комбинированный

CZ Motyčka s hrabičkami
RO Sapaliga + cultivator
H Kerti villás kapa
E Azadilla con escarificador

115 cm P



No.	L (cm)	type	☐
35764	115	P	5

PL Motyczka z pazurkami
GB Hoe + cultivator
D Kleinhacke
RUS Рыхлитель комбинированный

CZ Motyčka s hrabičkami
RO Sapaliga + cultivator
H Kerti villás kapa
E Azadilla con escarificador

115 cm P



No.	L (cm)	type	☐
35792	115	P	5

PL Motyka
GB Garden hoe
D Garten handhacke
RUS Тяпка

CZ Motyčka
RO Sapaliga
H Kerti kapa
E Azadilla

123 cm P



No.	L (cm)	working part width / szer. części roboczej (cm)	type	☐
35776	123	16	P	5

PL Motyka
GB Garden hoe
D Garten handhacke
RUS Тяпка

CZ Motyčka
RO Sapaliga
H Kerti kapa
E Azadilla

112 cm P



No.	L (cm)	working part width / szer. części roboczej (cm)	type	☐
35770	112	17	P	5

PL Motyka
GB Garden hoe
D Garten handhacke
RUS Тяпка

CZ Motyčka
RO Sapaliga
H Kerti kapa
E Azadilla

123 cm P



No.	L (cm)	working part width / szer. części roboczej (cm)	type	☐
35773	123	12	P	500
35774	123	14	P	250

PL Motyka
GB Garden hoe
D Garten handhacke
RUS Тяпка

CZ Motyčka
RO Sapaliga
H Kerti kapa
E Azadilla

120 cm P



No.	L (cm)	working part width / szer. części roboczej (cm)	type	☐
35761	120	12	P	250
35762	120	14	P	250

PL Motyka
GB Garden hoe
D Garten handhacke
RUS Тяпка

CZ Motyčka
RO Sapaliga
H Kerti kapa
E Azadilla

123 cm P



No.	L (cm)	working part width / szer. części roboczej (cm)	type	☐
35777	123	17	P	5

PL Obsypnik
GB Cultivator
D Häufner
RUS Культиватор

CZ Zaspávač
RO Cultivator
H Kultivátor
E Arado

190 mm



No.	L (mm)	☐
35710	190	5/15

PL Motyczka
GB Hoe
D Gärten handhacke
RUS Мотыжка

CZ Motyčka
RO Săpăligă
H Kerti kapa
E Azadilla

160 mm



No.	L (mm)	
35775	160	30

PL Motyczka z pazurkami
GB Hoe + cultivator
D Kleinhacke
RUS Рыхлитель
комбинированный

CZ Motyčka s hrabičkami
RO Săpăliga + cultivator
H Kerti villás kapa
E Azadilla con escarificador

80 mm



No.	L (mm)	
35760	80	60

PL Motyczka z pazurkami
GB Hoe + cultivator
D Kleinhacke
RUS Рыхлитель
комбинированный

CZ Motyčka s hrabičkami
RO Săpăliga + cultivator
H Kerti villás kapa
E Azadilla con escarificador

70 mm



No.	L (mm)	
35795	70	60

PL Kosa kuta
GB Forged scythe
D Sensenklänge geschmiedet
RUS Коса

CZ Kosa kovaná
RO Lama de coasa
H Kovácsolt kasza
E Guadana forjada



No.	type	
35824	No 6	25
35826	No 7	25
35828	No 8	25

PL Klepadło do kos
GB Stake for scythe
D Dengelamboss für sensen
RUS Бабка для отбивки кос (наковальня)

CZ Naklepávací kovadlinka
RO Inel de slăngere - pt. coasă
H Kaszarógzűző gyűrű
E Anillo para guadanás



No.	
35821	30

PL Pierścień do kos
GB Ring for scythe
D Befestigungsring für sense verzinkt
RUS Кольцо косное оцинкованное

CZ Údržbový prstenek
RO Bratară galvanizată pt. coasă
H Kaszarógzűző gyűrű
E Anillo para guadana



No.	
35823	30

PL Sierp
GB Sickle
D Sichel
RUS Серп

CZ Srp
RO Secera
H Sárló
E Hoz



No.	
35832	30

PL Trzonek do kos
GB Wooden handle for scythe
D Sensensiel
RUS Косовище деревянное

CZ Násada na kosu
RO Coada de coasa
H Kaszanyél
E Astil para guadanás

174 cm



No.	L (cm)	
35830	174	10

PL Klin drewniany do kosy
GB Wedge for scythe
D Holzkeil für sensen
RUS Клиn деревянный для косы

CZ Klin dřevěný na kosu
RO Pană de lemn pt. coasă
H Faék kaszához
E Cuna de madera para guadanás



No.

35831



12/144

PL Trzonek uniwersalny
GB Wooden handle
D Universalstiel
RUS Черенок для грабель

CZ Násada univerzální
RO Coadă din lemn
H Univerzális nyél
E Astil universal

P



No.	L (cm)	Ø (mm)	type	
99403	100	28	P	25
99404	110	28	P	25
99402	130	28	P	25
99408	150	28	P	25

PL Trzonek do siekiero-mlota
GB Handle for hammer-axe
D Stiel für Hammeraxt
RUS Черенок для топора

CZ Násada na sekeru
RO Coadă din lemn
H Baltányél
E Astil para hachuela

90 cm



No.

99405

L (cm)

90

for head / do obucha (kg)

2.5

10

99406

90

4.0

10

PL Trzonek do szpadla
GB Handle, T* for spade
D Spädelstiel T-griff
RUS Черенок для лопаты

CZ Násada na ryč
RO Coadă din lemn
H Ásónyél
E Astil para laya

90 cm

T



No.

99407

L (cm)

90

type

T

10

PL Trzonek do łopaty
GB Wooden handle for shovel
D Schaufelstiel gerade
RUS Черенок для лопаты

CZ Násada na lopatu
RO Coadă de lopată
H Lapátnyél
E Astil para pala

115 cm

T



No.

99409

L (cm)

115

type

T

10

PL Trzonek do łopaty
GB Wooden handle for shovel
D Schaufelstiel gerade
RUS Черенок для лопаты

CZ Násada na lopatu
RO Coadă de lopată cu maner
H Lapátnyél
E Astil para pala

130 cm

P



No.

99410

L (cm)

130

type

P

10

PL Trzonek
GB Wooden handle
D Schaufelstiel D-Griff
RUS Черенок для лопат

CZ Násada na lopatu
RO Coadă de lopată cu maner
H Lapátnyél
E Astil para pala

90 cm

DY



No.

99412

L (cm)

90

type

DY

10

PL Trzonek
GB Wooden handle
D Schaufelstiel D-Griff
RUS Черенок для лопат

CZ Násada na lopatu
RO Coadă de lopată cu maner
H Lapátnyél
E Astil para pala

90 cm

DY



No.

99413

L (cm)

90

type

DY

10

PL Trzonek do grabi wachlarzowych
GB Wooden handle
D Schaufelstiel D-Griff
RUS Черенок для лопат

CZ Násada na lopatu
RO Coadă de lopata cu maner
H Lapátnyél
E Astil para pala

130 cm P



No.	L (cm)	type	
99415	130	P	25

PL Trzonek do miotły z gwintem
GB Broom handle with thread
D Besenstiel, Holz, mit Gewinde
RUS Черенок для метлы с резьбой

CZ Násada na metlu se závitem
RO Coadă de mătură cu filet
H Menetes seprűnyél
E Astil para escoba con rosca

120 cm P



No.	L (cm)	type	Ø (mm)	
99416	120	P	22	25

PL Trzonek do miotły z gwintem
GB Broom handle with thread
D Besenstiel, Holz, mit Gewinde
RUS Черенок для метлы с резьбой

CZ Násada na metlu se závitem
RO Coadă de mătură cu filet
H Menetes seprűnyél
E Astil para escoba con rosca

120 cm P



No.	L (cm)	type	
99418	120	P	25

PL Trzonek metalowy z gwintem
GB Steel handle with thread
D Besenstiel mit Gewinde
RUS Черенок с резьбой

CZ Násada na metlu se závitem
RO Coadă cu filet
H Menetes seprűnyél
E Astil para escoba con rosca

116 cm P



No.	L (cm)	Ø (mm)	
99419	116	22	25

PL Trzonek do toporka
GB Wooden handle for hammer-axe
D Beilstiel
RUS Черенок для топора

CZ Násada na sekeru - kálač
RO Coadă de topor
H Ácsszekerce nyél
E Astil para hacha con martillo

40 cm



No.	L (cm)	for head / do obucha (kg)	
99426	40	0.6	25

PL Trzonek do toporka
GB Wooden handle for hammer-axe
D Beilstiel
RUS Черенок для топора

CZ Násada na sekeru - kálač
RO Coadă de topor
H Ácsszekerce nyél
E Astil para hacha con martillo

36 cm



No.	L (cm)	for head / do obucha (kg)	
99425	36	0.6	75

PL Trzonek do siekiery
GB Axe handle
D Axtstiel
RUS Рукоятка топора

CZ Topůrko do sekery
RO Cap de topor
H Báltányél
E Astil de hacha



No.	L (cm)	for head / do obucha (kg)	
99427	50	1.0	25
99428	60	1.0-1.25	25
99429	70	1.25-1.80	25

PL Trzonek do siekiery
GB Axe handle
D Axtstiel
RUS Рукоятка топора

CZ Topůrko do sekery
RO Cap de topor
H Báltányél
E Astil de hacha

80 cm



No.	L (cm)	for head / do obucha (kg)	
99430	80	1.8-2	25

PL Trzonek do młotka
 GB Hammer handle
 D Hammerstiel
 RUS Ручка молотка

CZ Topůrko do kladiva
 RO Cap de ciocan
 H Kalapácsnyél
 E Astil de martillo



No.	L (cm)	for head / do obucha (kg)	
99435	28	0.1-0.3	65
99436	32	0.3-0.7	65
99438	36	0.7-1.5	65
99440	40	0.8-2.0	50
99442	50	2.0-3.0	50
99443	60	3.0-4.0	25
99444	70	4.0-6.0	25
99445	80	5.0-8.0	25
99446	90	8.0-10	10

PL Rękawice robocze
 GB Working gloves
 D Arbeitshandschuh
 RUS Перчатки
 CZ Pracovní rukavice
 RO Mănuși
 H Védőkesztyű
 E Guantes



No.	pairs / pary	
74100	1	12/300
74101	3	4/100

PL Rękawice robocze
 GB Working gloves
 D Arbeitshandschuh
 RUS Перчатки
 CZ Pracovní rukavice
 RO Mănuși
 H Védőkesztyű
 E Guantes



No.	pairs / pary	size / rozmiar	
74110	1	9	12/300
74111	3	9	4/100

PL Rękawice robocze
 GB Working gloves
 D Arbeitshandschuh
 RUS Перчатки
 CZ Pracovní rukavice
 RO Mănuși
 H Védőkesztyű
 E Guantes



No.	size / rozmiar	
74125	8	12/300
74130	9	12/300
74131	10	12/300

PL Rękawice robocze
 GB Working gloves
 D Arbeitshandschuh
 RUS Перчатки
 CZ Pracovní rukavice
 RO Mănuși
 H Védőkesztyű
 E Guantes



No.	size / rozmiar	
74126	8	12/300
74132	9	12/300
74133	10	12/300

PL Rękawice robocze
 GB Working gloves
 D Arbeitshandschuh
 RUS Перчатки
 CZ Pracovní rukavice
 RO Mănuși
 H Védőkesztyű
 E Guantes



No.	size / rozmiar	
74127	8	12/300
74134	9	12/300
74135	10	12/300

PL Rękawice robocze
 GB Working gloves
 D Arbeitshandschuh
 RUS Перчатки
 CZ Pracovní rukavice
 RO Mănuși
 H Védőkesztyű
 E Guantes



No.	size / rozmiar	
74128	8	12/300
74136	9	12/300
74137	10	12/300

PL Rękawice ogrodnicze
 GB Gardening gloves
 D Arbeitshandschuh
 RUS Перчатки

CZ Pracovní rukavice
 RO Mănuși
 H Védőkesztyű
 E Guantes



No.	size / rozmiar	
74117	8	50/1000

PL Rękawice ogrodnicze
GB Gardening gloves
D Arbeitshandschuh
RUS Перчатки

CZ Pracovní rukavice
RO Mănuși
H Védőkesztyű
E Guantes



No.	size / rozmiar	
74121	8	50/1000

PL Rękawice ogrodnicze
GB Gardening gloves
D Arbeitshandschuh
RUS Перчатки

CZ Pracovní rukavice
RO Mănuși
H Védőkesztyű
E Guantes



No.	size / rozmiar	
74123	8	50/1000

PL Rękawice ogrodnicze
GB Gardening gloves
D Arbeitshandschuh
RUS Перчатки

CZ Pracovní rukavice
RO Mănuși
H Védőkesztyű
E Guantes



No.	size / rozmiar	
74113	8	50/1000

PL Rękawice ogrodnicze
GB Gardening gloves
D Arbeitshandschuh
RUS Перчатки

CZ Pracovní rukavice
RO Mănuși
H Védőkesztyű
E Guantes



No.	size / rozmiar	
74115	8	50/1000

PL Kask ochronny
GB Safety helmet
D Schutzhelm
RUS Каска защитная
CZ Ochranná přilba
RO Cască de protecție
H Védősisak
E Casco de protección



No.	colour / kolor	
74190	○	40
74191	●	40
74192	●	40
74193	●	40
74194	●	40
74195	●	40

PL Okulary ochronne
GB Safety glasses
D Schutzbrille
RUS Очки защитные открытые

CZ Ochranné brýle
RO Ochelari pt. protectie
H Védőszemüveg
E Gafas protectoras



No.	type	
74501	HF-111	12/240

PL Okulary ochronne
GB Safety glasses
D Schutzbrille
RUS Очки защитные открытые

CZ Ochranné brýle
RO Ochelari pt. protectie
H Védőszemüveg
E Gafas protectoras



No.	type	
74502	HF-110	12/240

PL Okulary ochronne
GB Safety glasses
D Schutzbrille
RUS Очки защитные открытые

CZ Ochranné brýle
RO Ochelari pt. protectie
H Védőszemüveg
E Gafas protectoras



No.	type	
74503	DY-8525	15/150

PL Okulary ochronne
GB Safety glasses
D Schutzbrille
RUS Очки защитные открытые

CZ Ochranné brýle
RO Ochelari pt. protectie
H Védőszemüveg
E Gafas protectoras



No.	type	
74504	DY-8526	15/150

PL Okulary ochronne
GB Safety glasses
D Schutzbrille
RUS Очки защитные открытые

CZ Ochranné brýle
RO Ochelari pt. protectie
H Védőszemüveg
E Gafas protectoras



No.	type	
74508	HF-103	10/120

PL Okulary ochronne
GB Safety glasses
D Schutzbrille
RUS Очки защитные открытые

CZ Ochranné brýle
RO Ochelari pt. protectie
H Védőszemüveg
E Gafas protectoras



No.	type	
74509	HF-105	10/100

PL Przyłbica z osłoną wymienną
GB Face shield with PC visor
D Schweißerschutzhelm mit austauschbarer Abdeckung
RUS Шлем с заменяемой защитой
CZ Štít s vyměnitelným krytem
RO Vizieră cu protecție schimbabilă
H Arcvédő cserélhető pajzzsal
E Antifaz con protección reemplazable

VISOR
OSLONA
395x200
mm



No.	
74461	40

PL Nauszniki przeciwhałasowe
GB Ear muff
D Gehörschutz
RUS Средства защиты слуха

CZ Chrániče sluchu
RO Antifoane
H Fülvédőt
E Protectores de la vista

SNR
24dB



No.	
74458	60

PL Nauszniki przeciwhałasowe
GB Ear muff
D Gehörschutz
RUS Средства защиты слуха

CZ Chrániče sluchu
RO Antifoane
H Fülvédőt
E Protectores de la vista



No.	
74451	10/60

PL Przyłbica z osłoną wymienną i nausznikami przeciwhałasowymi
GB Face shield with steel mesh and ear muff
D Schweißerschutzhelm mit austauschbarer Abdeckung und Ohrenschrützer gegen Lärm
RUS Шлем с заменяемой защитой и наушниками против шума
CZ Štít s vyměnitelným krytem a chrániči proti hluku
RO Vizieră cu protecție schimbabilă și căști de protecție antigomot
H Arcvédő cserélhető pajzzsal és fülvédő kagylóval
E Antifaz con protección reemplazable y protectores de oídos

MESH
OSLONA
395x200
mm



No.	
74462	40

PL Kask ochronny drwala
 GB Lumberjack helmet
 D Schutzhelm für Holzfäller
 RUS Защитный шлем лесоруба
 CZ Ochranná přilba pro dřevorubce
 RO Casă de protecție pt. tăietor de lemne
 H Favágó védősisak
 E Casco de leñador



SNR
23 dB

ABS



No.

74201



8

PL Nakolanniki CZ Chrániče kolen
 GB Knee pads RO Genunchiere
 D Knieschützer H Térdvédő
 RUS Наколенники E Rodilleras



No.

74600



50

PL Nakolanniki CZ Chrániče kolen
 GB Knee pads RO Genunchiere
 D Knieschützer H Térdvédő
 RUS Наколенники E Rodilleras



No.

74610



20

PL Nakolanniki CZ Chrániče kolen
 GB Knee pads RO Genunchiere
 D Knieschützer H Térdvédő
 RUS Наколенники E Rodilleras



No.

74620



12/48

PL Nakolanniki CZ Chrániče kolen
 GB Knee pads RO Genunchiere
 D Knieschützer H Térdvédő
 RUS Наколенники E Rodilleras



No.

74622



50

PL Nakolanniki CZ Chrániče kolen
 GB Knee pads RO Genunchiere
 D Knieschützer H Térdvédő
 RUS Наколенники E Rodilleras



No.

74624



12/24

PL Nakolanniki CZ Chrániče kolen
 GB Knee pads RO Genunchiere
 D Knieschützer H Térdvédő
 RUS Наколенники E Rodilleras



No.

74601



24

PL Nakolanniki CZ Chrániče kolen
 GB Knee pads RO Genunchiere
 D Knieschützer H Térdvédő
 RUS Наколенники E Rodilleras



No.

74602



6/36

PL Nakolanniki
GB Knee pads
D Knieschützer
RUS Наколенники

CZ Chrániče kolen
RO Genunchiere
H Térdvédő
E Rodilleras



No.	12/24
74623	

PL Kalosze męskie
GB Men's rain boots
D Herren - Gummistiefel
RUS Галоши мужские

CZ Pánské galoše
RO Cizme bărbați
H Férfi gumicsizma
E Chanclos para hombre



No.	size / rozmiar	model	
72840	41	PREDATOR XL	6
72841	42	PREDATOR XL	6
72842	43	PREDATOR XL	6
72843	44	PREDATOR XL	6
72844	45	PREDATOR XL	6
72845	46	PREDATOR XL	6
72846	47	PREDATOR XL	6

PL Kalosze męskie
GB Men's rain boots
D Herren - Gummistiefel
RUS Галоши мужские

CZ Pánské galoše
RO Cizme bărbați
H Férfi gumicsizma
E Chanclos para hombre



No.	size / rozmiar	model	
72858	41	GRAND BLACK	8
72859	42	GRAND BLACK	8
72860	43	GRAND BLACK	8
72861	44	GRAND BLACK	8
72862	45	GRAND BLACK	6
72863	46	GRAND BLACK	6
72864	47	GRAND BLACK	6

PL Kalosze damskie
GB Women's rain boots
D Damen - Gummistiefel
RUS Галоши женские

CZ Dámské galoše
RO Cizme damă
H Női gumicsizma
E Chanclos para mujer



No.	size / rozmiar	model	
72831	36	LUNA	7
72832	37	LUNA	7
72833	38	LUNA	7
72834	39	LUNA	5
72835	40	LUNA	5
72836	41	LUNA	5

PL Kalosze damskie
GB Women's rain boots
D Damen - Gummistiefel
RUS Галоши женские

CZ Dámské galoše
RO Cizme damă
H Női gumicsizma
E Chanclos para mujer



No.	size / rozmiar	model	
72850	36	RAINY BLACK	10
72851	37	RAINY BLACK	10
72852	38	RAINY BLACK	10
72853	39	RAINY BLACK	10
72854	40	RAINY BLACK	10

PL Spodnie ogrodnicze
GB Garden trousers
D Gartenhosen
RUS Брюки садовые
CZ Zahradnické kalhoty
RO Pantaloni pt. grădinarit
H Kertész nadrág
E Pantalón de jardinería



No.	size / rozmiar	
72900	S	10
72901	M	10
72902	L	10
72903	XL	10

PL Łopata do śniegu
GB Plastic shovel for snow
D Kunststoff-schneeschaufel
RUS Лопата снеговая

CZ Lopata na sněh
RO Lopată pt. zăpadă
H Műanyag hólapát
E Pala para nieve



No.

35880



180

PL Łopata do śniegu
GB Plastic shovel for snow
D Kunststoff-schneeschaufel
RUS Лопата снеговая

CZ Lopata na sněh
RO Lopată pt. zăpadă
H Műanyag hólapát
E Pala para nieve



VOREL

No.

35881

mm

330x390



270

PL Łopata do śniegu
GB Plastic shovel for snow
D Kunststoff-schneeschaufel
RUS Лопата снеговая

CZ Lopata na sněh
RO Lopată pt. zăpadă
H Műanyag hólapát
E Pala para nieve



VOREL

No.

35889

mm

400x430



180

PL Skuwacz do lodu
GB Ice breaker
D Eishammer
RUS Прибор для скобления льда

CZ Skováč na led
RO Spărgător pt. gheață
H Jégfőrdő
E Rompehielo mango



VOREL

No.

35878



125

PL Pompka do spryskiwacza
GB Pump for pressure sprayer
D Druckpumpe für Drucksprüher
RUS Насос на опрыскиватели

CZ Pumpa do postřikovače
RO Pompa pt. vermores
H Szivattyú tömlővég készlet
E Bomba para el rociador



FLO

No.

89536

for / dla

89515; 89518; 89520



60

PL Końcówka rozpylająca do spryskiwaczy
GB Straight nozzle for pressure sprayer
D Sprühdüse für Drucksprüher
RUS Распылитель на опрыскиватели
CZ Rozprašovaci koncovka k postřikovači
RO Doza pt. vermores
H Porlasztó tömlővég esőztetőhöz
E Puna de atomización para rociador



FLO

No.

89537

for / dla

89515; 89518; 89520



300

PL Zestaw końcówek rozpylających
GB Spray nozzle set
D Spritzdüsenatz
RUS Форсунки сменные для опрыскивателей

CZ Sada rozprašovacích koncovek
RO Set racorduri vermores
H Porlasztó tömlővég készlet
E Juego de boquillas rociadores



FLO

No.

89538



100

PL Pistolet do opryskiwacza
GB Shower spray gun
D Spritzpistole
RUS Пистолет для опрыскивателей

CZ Rozprašovaci pistole na vodu
RO Pistol pt. stropit
H Locsoló pisztoly
E Pistola de pulverización ajustable



FLO

No.

89539



200

PL Pistolet do opryskiwacza
 GB Shower spray gun
 D Spritzpistole
 RUS Пистолет для опрыскивателей

CZ Rozprašovací pistole na vodu
 RO Pistol pt. stropit
 H Locsoló pisztoly
 E Pistola de pulverización ajustable



FLO

No.		
89540		200

PL Lanza z włókna szklanego
 GB Fibreglass spray lance
 D Fibreglaslanze
 RUS Трубка фиберглассовая

CZ Násadec postřikovače ze skleněného vlákna
 RO Lance din fibra de sticlă
 H Üveggyapot lándzsa
 E Lanza de fibra de vidrio



FLO

No.	L (cm)	Ø (mm)	
89541	80	8	250

PL Lanza teleskopowa
 GB Telescopic handle
 D Teleskoplanze
 RUS Штанга телескопическая для опрыскивателя

CZ Násadec teleskopický
 RO Maner telescopic
 H Teleszkópos lándzsa
 E Lanza telescópica



FLO

No.	L (cm)	
89542	70-118	100

PL Przyłącze 4-dyszowe
 GB 4-nozzle connector
 D Querlanze mit 4 Düsen
 RUS Штанга с 4 форсунками для опрыскивателей (вертикальная)

CZ Připojka 4-trysková
 RO Sistem îngrădii
 H 4-fűvökös csatlakozó
 E Conexión de cuatro surtidores



FLO

No.	L (mm)	
89543	645	100

PL Zestaw uszczelek do spryskiwaczy
 GB Set of gaskets for pressure sprayer
 D Dichtungssatz für Drucksprüher
 RUS Набор прокладок для опрыскивателя

CZ Sada těsnění k postřikovači
 RO Set de garnituri pt. vermores
 H Tömítéskészlet esőztetőhöz
 E Juego de juntas para rociadores



FLO

No.	for / dla	
89545	89515; 89518; 89520	500

PL Zestaw uszczelek do spryskiwaczy
 GB Set of gaskets for pressure sprayer
 D Dichtungssatz für Drucksprüher
 RUS Набор прокладок для опрыскивателя

CZ Sada těsnění k postřikovači
 RO Set de garnituri pt. vermores
 H Tömítéskészlet esőztetőhöz
 E Juego de juntas para rociadores

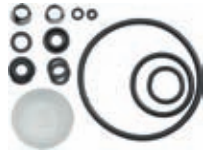

FLO

No.	for / dla	
89546	89525	500

PL Zestaw uszczelek do spryskiwaczy
 GB Set of gaskets for pressure sprayer
 D Dichtungssatz für Drucksprüher
 RUS Набор прокладок для опрыскивателя

CZ Sada těsnění k postřikovači
 RO Set de garnituri pt. vermores
 H Tömítéskészlet esőztetőhöz
 E Juego de juntas para rociadores



FLO

No.	for / dla	
89547	89526	500

PL Miota
 GB Broom
 D Strassenbesen
 RUS Метла

CZ Metla
 RO Mătură
 H Partvis
 E Cepillo pelo largo



SORGO

No.	L (mm)	
35911	1150x22	140

PL Miotła
GB Broom
D Strassenbesen
RUS Метла

CZ Metla
RO Matura
H Partvis
E Cepillo pelo largo



No.	L (mm)	
35912	1200x22	15

PL Miotła
GB Broom
D Strassenbesen
RUS Метла

CZ Metla
RO Matura
H Partvis
E Cepillo pelo largo



No.	L (mm)	
35893	300	12
35894	400	12
35895	500	12

PL Miotła
GB Broom
D Strassenbesen
RUS Метла

CZ Metla
RO Matura
H Partvis
E Cepillo pelo largo



No.	L (mm)	
35899	250	12

PL Żyłka tnąca
GB Grass trimmer line
D Mähfaden
RUS Леска для триммера
CZ Struna do strunové sekačky
RO Furtun gradina
H Damil szegélynyíró géphez
E Hilo de cortar



No.	Ø (mm)	L (m)	profil	
89401	1.3	10	O	20/240
89402	1.6	10	O	20/240
89403	2.0	10	O	20/240
89404	2.4	10	O	12/144
89405	2.6	10	O	12/144
89406	3.0	10	O	12/144

PL Żyłka tnąca
GB Grass trimmer line
D Mähfaden
RUS Леска для триммера
CZ Struna do strunové sekačky
RO Furtun gradina
H Damil szegélynyíró géphez
E Hilo de cortar



No.	Ø (mm)	L (m)	profil	
89441	2.0	120	O	27
89442	2.4	90	O	27
89443	2.6	70	O	27
89444	3.0	56	O	27
89445	3.3	45	O	27

PL Żyłka tnąca
GB Grass trimmer line
D Mähfaden
RUS Леска для триммера
CZ Struna do strunové sekačky
RO Furtun gradina
H Damil szegélynyíró géphez
E Hilo de cortar



No.	Ø (mm)	L (m)	profil	
89411	1.3	10	□	20/240
89412	1.6	10	□	20/240
89413	2.0	10	□	20/240
89414	2.4	10	□	12/144
89415	2.6	10	□	12/144
89416	3.0	10	□	12/144

PL Żyłka tnąca
GB Grass trimmer line
D Mähfaden
RUS Леска для триммера
CZ Struna do strunové sekačky
RO Furtun gradina
H Damil szegélynyíró géphez
E Hilo de cortar



No.	Ø (mm)	L (m)	profil	
89452	2.4	90	□	16
89453	2.6	70	□	16
89454	3.0	56	□	16

PL Żyłka tnąca
GB Grass trimmer line
D Mähfaden
RUS Леска для триммера
CZ Struna do strunové sekačky
RO Furtun gradina
H Damil szegélynyíró géphez
E Hilo de cortar



No.	Ø (mm)	L (m)	profil	
89421	1.3	15	☆	24/288
89422	1.6	15	☆	20/240
89423	2.0	15	☆	16/192
89424	2.4	15	☆	12/144
89425	2.6	15	☆	12/144
89426	3.0	15	☆	10/120

PL Żyłka tnąca
GB Grass trimmer line
D Mähfaden
RUS Леска для триммера
CZ Struna do strunové sekačky
RO Furtun gradina
H Damil szegélynyíró géphez
E Hilo de cortar



No.	Ø (mm)	L (m)	profil	
89456	2.0	90	☆	9/27
89457	2.4	90	☆	9/27
89458	2.6	90	☆	9/27
89459	3.0	60	☆	9/27

PL Żyłka tnąca
GB Grass trimmer line
D Mähfaden
RUS Леска для триммера

CZ Struna do strunové sekačky
RO Furtun gradina
H Damil szegélynyíró géphez
E Hilo de cortar



EXTRANYL

No.	Ø (mm)	L (m)	profil	
89462	2.4	15		10/120
89463	2.7	15		10/120
89464	3.0	12		10/120

PL Żyłka tnąca
GB Grass trimmer line
D Mähfaden
RUS Леска для триммера
CZ Struna do strunové sekačky
RO Furtun gradina
H Damil szegélynyíró géphez
E Hilo de cortar



EXTRANYL

No.	Ø (mm)	L (m)	profil	
89465	2.4	90		10/20
89466	2.7	70		10/20
89467	3.0	60		10/20

PL Żyłka tnąca
GB Grass trimmer line
D Mähfaden
RUS Леска для триммера
CZ Struna do strunové sekačky
RO Furtun gradina
H Damil szegélynyíró géphez
E Hilo de cortar

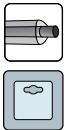

TRYGON

No.	Ø (mm)	L (m)	profil	
89470	2.4	15		10/120
89471	2.7	15		10/120
89472	3.0	12		10/120

PL Żyłka tnąca
GB Grass trimmer line
D Mähfaden
RUS Леска для триммера
CZ Struna do strunové sekačky
RO Furtun gradina
H Damil szegélynyíró géphez
E Hilo de cortar



TRYGON

No.	Ø (mm)	L (m)	profil	
89473	2.4	90		10/20
89474	2.7	70		10/20
89475	3.0	60		10/20

PL Żyłka tnąca
GB Grass trimmer line
D Mähfaden
RUS Леска для триммера
CZ Struna do strunové sekačky
RO Furtun gradina
H Damil szegélynyíró géphez
E Hilo de cortar



SILENT

No.	Ø (mm)	L (m)	profil	
89478	1.6	15		20/240
89479	2.0	15		20/240
89480	2.4	15		10/120
89481	2.7	15		10/120
89482	3.0	12		10/120

PL Żyłka tnąca
GB Grass trimmer line
D Mähfaden
RUS Леска для триммера
CZ Struna do strunové sekačky
RO Furtun gradina
H Damil szegélynyíró géphez
E Hilo de cortar



SILENT

No.	Ø (mm)	L (m)	profil	
89483	2.0	90		10/20
89484	2.4	90		10/20
89485	2.7	70		10/20
89486	3.0	60		10/20



PL Zbierak do owoców
GB Fruit pick up tool
D Obstpfücker
RUS Съёмник для фруктов

CZ Sběrač ovoce
RO Culegator pt. fructe
H Karos gyümölcszedő
E Recolector de frutas



No.	Ø (mm)	
89880	160	12/48

PL Konewka dwustronna
GB Watering can
D Gießkanne
RUS Лейка
CZ Konvíčka
RO Stropitoare
H Locsolókanna
E Regadera

FLO

No.	l	colour / kolor	
89490	1.0	●	72
89491	1.0	●	72
89492	1.6	●	48
89493	1.6	●	48

PL Drut ogrodniczy
GB Twist tie
D Gartendraht
RUS Проволока огородная

CZ Drát pro zahrádkáře
RO Sârmă pt. grădină
H Kötöződrót
E Alambre de jardinero

2 PCS **50** m



FLO

No.	L (m)	
88801	50	12/48

PL Drut ogrodniczy powlekany z obcinaczem
GB Twist tie with cutter
D Gartendraht, beschichtet, mit Abschnneider
RUS Проволока огородная с диспенсером
CZ Drát pro zahrádkáře s SODMPP VRCřezávačem
RO Sârmă pt. grădină izolată cu tăietor
H Galvanizált kötöződrót, darabolóval
E Alambre de jardinero cubierto con tronizador



FLO

No.	L (m)	
88805	30	24/144
88806	50	24/144

PL Drut ogrodniczy w osłonie z pianki
GB Garden flexible tie
D Gartendraht, in einer Abdeckung aus Schaumstoff
RUS Проволока огородная покрытая пенкой
CZ Drát pro zahrádkáře s pěnovým pláštěm
RO Sârmă pt. grădină cu izolație din spumă
H Kötöződrót, plasztik bevonattal
E Alambre de jardinero en cubierta de espuma

10m
 Ø10mm



FLO

No.	L (m)	
88809	10	40

PL Zestaw ogrodniczy do podwiązywania roślin
GB Plant binding set
D Gartensatz zum Abbinden von Pflanzen
RUS Набор огородный для подвязки растений
CZ Souprava pro zahrádkáře k vyvazování rostlin
RO Set pt. grădină pt. legare plante
H Kertészeti szett növények felkötéséhez
E Juego para jardín para sujetar plantas

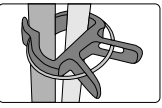
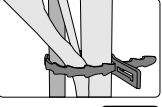

71 PCS

FLO

No.	pcs	
88811	71	24

PL Miernik ogrodniczy
GB Soil survey instrument
D Gartenmessgerät
RUS Измеритель огородный
CZ Zahradnický měřicí přístroj
RO Aparat de măsurat grădinăresc
H Négyfunkciós, kerti mérőműszer
E Medidor de horticultor

9V 6F22
pH
TEMP °C/°F

FLO

No.		
89000		10

PL Przedłużacz
GB Garden extension cable
D Gartenverlängerungskabel
RUS Электрорудлинитель

CZ 3 ÚROZDĚLYNĚNÍ DRÁHOV
RO Prelungitor electric
H Kerti hosszabbító
E Cable de extensión para jardín

230V~
50Hz



FLO

No.	L (m)	
82671	10	10
82673	20	10
82675	30	5

PL Widelec do grilla
GB BBQ fork
D Grillgabel
RUS Вилка для гриля

CZ Vidlice na grilla
RO Furculiță cromată pt. grătar
H Villa a grillhez krómozott
E Tenedor para barbacoa



FLO

No.	L (cm)	
99530	49	12/96

23

Sanitary ware & hydraulics Armatura sanitarna i hydraulika

Mixers, faucets
Baterie

.....350-351

**Water regulators**
Reduktory przepływu wody

.....351-352

**Pop-up wastes**
Korki automatyczne

.....352-353

**Shower handles**
Słuchawki prysznicowe

.....353-356

**Shower & connecting hoses**
Wężę prysznicowe i przyłączeniowe

.....356-359

**Bathroom & shower sets**
Komplety łazienkowe i prysznicowe

.....359-360

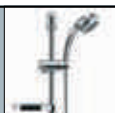
**Bathroom accessories**
Akcesoria łazienkowe

.....360-361

**Toilet seats & soft baby toilet seats**
Deski toaletowe i nakładki toaletowe

.....362

**Bathroom scales**
Wagi łazienkowe

.....362

**Plastic stools**
Stołki plastikowe

.....362

**Hydraulic accessories**
Akcesoria hydrauliczne

.....362-363



- PL Bateria wannowa, naścienna
- GB Wall mounted bathtub mixer
- D Badewanne-wassermischer
- RUS Смеситель для ванны
- CZ Vanová baterie nástěnná
- RO Baterie monocomandă duș + cadă - fixare perete
- H Kádítóltő csaptelep, fali
- E Bateria de banera de pared



No.	mm	
75510	134-166	12

- PL Bateria kuchenna, naścienna
- GB Wall mounted kitchen mixer
- D Küche-wandwassermischer
- RUS Смеситель для кухни

- CZ Kuchyňská baterie nástěnná
- RO Baterie monocomandă chiuvetă - fixare perete
- H Mosogató csaptelep, fali
- E Bateria de cocina de pared

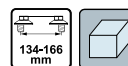

No.	mm	
75511	134-166	12

- PL Bateria prysznicowa naścienna
- GB Wall mounted shower mixer
- D Badewanne-wassermischer
- RUS Смеситель для душа
- CZ Sprchová baterie nástěnná
- RO Baterie monocomandă duș - fixare perete fundido
- H Zuhanycsaptelep, fali
- E Bateria dos grifos, de ducha, de pared



No.	mm	
75512	134-166	12

- PL Bateria kuchenna sztorcowa
- GB Vertical kitchen mixer
- D Spülbecken-wassermischer
- RUS Смеситель для кухни
- CZ Dřevová stojánková baterie
- RO Baterie monocomandă chiuvetă - fixare verticală
- H Mosogató csaptelep, álló
- E Bateria de cocina de lado



No.		
75514		12

- PL Bateria umywalkowa naścienna
- GB Wall mounted wash-basin mixer
- D Waschbecken-wandwassermischer
- RUS Смеситель для умывальника

- CZ Umyvadlová baterie nástěnná
- RO Baterie monocomandă chiuvetă - fixare perete
- H Mosdó csaptelep, fali
- E Bateria de lavabo de pared

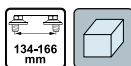

No.	mm	
75516	134-166	12

- PL Bateria wannowa, naścienna
- GB Wall mounted bathtub mixer
- D Badewanne-wassermischer
- RUS Смеситель для ванны
- CZ Vanová baterie nástěnná
- RO Baterie monocomandă duș + cadă - fixare perete
- H Kádítóltő csaptelep, fali
- E Bateria de banera de pared



FALA

No.	mm	type	
75500	133-168	NIAGARA	12

- PL Bateria kuchenna, naścienna
- GB Wall mounted kitchen mixer
- D Küche-wandwassermischer
- RUS Смеситель для кухни

- CZ Kuchyňská baterie nástěnná
- RO Baterie monocomandă chiuvetă - fixare perete
- H Mosogató csaptelep, fali
- E Bateria de cocina de pared



FALA

No.	mm	type	
75501	133-168	NIAGARA	12

- PL Bateria prysznicowa naścienna
- GB Wall mounted shower mixer
- D Badewanne-wassermischer
- RUS Смеситель для душа
- CZ Sprchová baterie nástěnná
- RO Baterie monocomandă duș - fixare perete fundido
- H Zuhanycsaptelep, fali
- E Bateria dos grifos, de ducha, de pared



FALA

No.	mm	type	
75502	133-168	NIAGARA	12

- PL Bateria umywalkowa sztorcowa
 GB Vertical wash-basin mixer
 D Waschbecken-wassermischer
 RUS Смеситель для умывальника
 CZ Umyvadlová baterie vzhůru
 RO Baterie monocomandă chiuvetă - fixare verticală
 H Mosdó csaptelep, álló
 E Bateria de lavabo de ladofundido

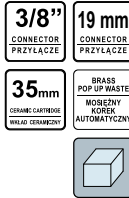

FALA

No.	type	
75503	NIAGARA	12

- PL Bateria kuchenna sztorcowa
 GB Vertical kitchen mixer
 D Spülbecken-wassermischer
 RUS Смеситель для кухни
 CZ Dřezová stojánková baterie
 RO Baterie monocomandă chiuvetă - fixare verticală
 H Mosogató csaptelep, álló
 E Bateria de cocina de lado



FALA

No.	type	
75504	NIAGARA	12

- PL Bateria umywalkowa naścienna
 GB Wall mounted wash-basin mixer
 D Waschbecken-wandwassermischer
 RUS Смеситель для умывальника
 CZ Umyvadlová baterie nástěnná
 RO Baterie monocomandă chiuvetă - fixare perete
 H Mosdó csaptelep, fall
 E Bateria de lavabo de pared



FALA

No.	mm	type	
75506	133-168	NIAGARA	12

- PL Perlator i zestaw uszczelkek do baterii FALA
 GB Aerator and sealing set for sanitary mixers FALA
 D Strahlregler- und dichtungsgummissatz für armatur FALA
 RUS Аэратор с набором прокладок для смесителя FALA
 CZ Perlátor a sada těsnění do baterie FALA
 RO Sila si garnituri pt. baterii sanitare FALA
 H Levegőtöltő és tömítőgumi készlet FALA csaptelephez
 E Aireado y juego de juntas



FALA

No.	
75327	25/200

- PL Reduktor przepływu wody
 GB Water flow rate reducer
 D Wassersparer
 RUS Регулятор расхода воды
 CZ Regulátor toku vody
 RO Reductor de debit de apă
 H Áramlás korlátozó
 E Regulador de flujo de agua

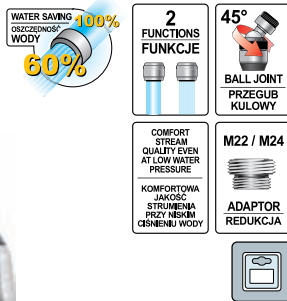

FALA

No.	
75328	10/60

- PL Reduktor przepływu wody
 GB Water flow rate reducer
 D Wassersparer
 RUS Регулятор расхода воды
 CZ Regulátor toku vody
 RO Reductor de debit de apă
 H Áramlás korlátozó
 E Regulador de flujo de agua

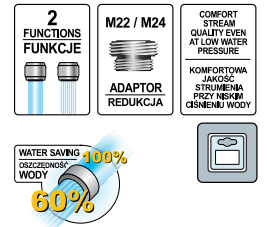

FALA

No.	
75329	10/60

- PL Reduktor przepływu wody
 GB Water flow rate reducer
 D Wassersparer
 RUS Регулятор расхода воды
 CZ Regulátor toku vody
 RO Reductor de debit de apă
 H Áramlás korlátozó
 E Regulador de flujo de agua

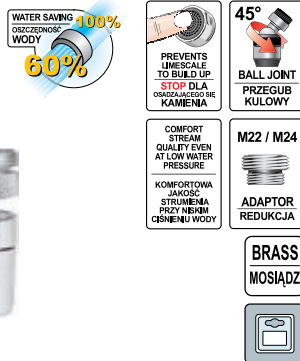

FALA

No.	
75330	10/60

- PL Reduktor przepływu wody
 GB Water flow rate reducer
 D Wassersparer
 RUS Регулятор расхода воды
 CZ Regulátor toku vody
 RO Reductor de debit de apă
 H Áramlás korlátozó
 E Regulador de flujo de agua

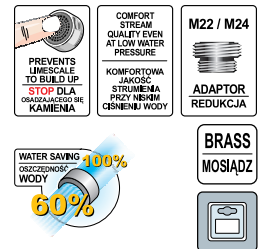

FALA

No.	
75331	10/60

PL Reduktor przepływu wody
 GB Water flow rate reducer
 D Wassersparer
 RUS Регулятор расхода воды
 CZ Regulátor toku vody
 RO Reductor de debit de apă
 H Áramlás korlátozó
 E Regulador de flujo de agua

WATER SAVING 100%
 Oszczędność WODY 60%

PREVENTS LIMESCALE TO BUILD UP STOP DLA OBRZĄŻAJĄCEGO SIĘ KAMIENIA

COMFORT STREAM QUALITY EVEN AT LOW WATER PRESSURE

KOMFORTOWA JAKOŚĆ STRUMIENIA PRZY NISKIM CIŚNIENIU WODY

M 24
 UNIVERSAL THREAD
 UNIWERSALNY GWINT

FALA

No.	
75332	10/60

PL Reduktor przepływu wody
 GB Water flow rate reducer
 D Wassersparer
 RUS Регулятор расхода воды
 CZ Regulátor toku vody
 RO Reductor de debit de apă
 H Áramlás korlátozó
 E Regulador de flujo de agua

BRASS
 MOSIADZ

COMFORT STREAM QUALITY EVEN AT LOW WATER PRESSURE

KOMFORTOWA JAKOŚĆ STRUMIENIA PRZY NISKIM CIŚNIENIU WODY

G 1/2
 UNIVERSAL THREAD
 UNIWERSALNY GWINT

WATER SAVING 100%
 Oszczędność WODY 60%

FALA

No.	
75333	10/60

PL Korek do umywalki
 GB Pop-up waste
 D Waschbecken stöpsel
 RUS Автоматическая пробка
 CZ Automatická zátká
 RO Sifon chiuveta
 H Mosdo lefolyó elzáró
 E Tapón automat. para batería de lado

FALA

No.	
75498	12/48

PL Korek do umywalki
 GB Pop-up waste
 D Waschbecken stöpsel
 RUS Автоматическая пробка
 CZ Automatická zátká
 RO Sifon chiuveta
 H Mosdo lefolyó elzáró
 E Tapón automat. para batería de lado

FALA

No.	
75499	12/48

PL Korek automatyczny
 GB Pop-up waste
 D Waschbecken stöpsel
 RUS Автоматическая пробка для умывальника
 CZ Automatická zátká
 RO Sifon chiuveta
 H Mosdo lefolyó elzáró
 E Tapón automat. para batería de lado

CLICK - CLACK

EASY TO CLEAN UNDO A PLUG POSSIBILITY

LATWE CZYSZCZENIE MOŻLIWOŚĆ ODKRĘCENIA KÓRKA

G 1 1/4
 UNIVERSAL THREAD
 UNIWERSALNY GWINT

FOR WASH BASIN WITH OVERFLOW DO UMYWALEK Z PRZELIWIEM

CHROME PLATED
 CHROMOWANY

FALA

No.	
75483	48/96

PL Korek automatyczny
 GB Pop-up waste
 D Waschbecken stöpsel
 RUS Автоматическая пробка для умывальника
 CZ Automatická zátká
 RO Sifon chiuveta
 H Mosdo lefolyó elzáró
 E Tapón automat. para batería de lado

CLICK - CLACK

EASY TO CLEAN UNDO A PLUG POSSIBILITY

LATWE CZYSZCZENIE MOŻLIWOŚĆ ODKRĘCENIA KÓRKA

G 1 1/4
 UNIVERSAL THREAD
 UNIWERSALNY GWINT

FOR WASH BASIN WITH OVERFLOW DO UMYWALEK Z PRZELIWIEM

BRASS
 MOSIADZ

CHROME PLATED
 CHROMOWANY

FALA

No.	
75484	20/40

PL Korek automatyczny
 GB Pop-up waste
 D Waschbecken stöpsel
 RUS Автоматическая пробка для умывальника
 CZ Automatická zátká
 RO Sifon chiuveta
 H Mosdo lefolyó elzáró
 E Tapón automat. para batería de lado

CLICK - CLACK

EASY TO CLEAN UNDO A PLUG POSSIBILITY

LATWE CZYSZCZENIE MOŻLIWOŚĆ ODKRĘCENIA KÓRKA

G 1 1/4
 UNIVERSAL THREAD
 UNIWERSALNY GWINT

FOR WASH BASIN WITH OVERFLOW DO UMYWALEK Z PRZELIWIEM

BRASS
 MOSIADZ

BRUSHED NICKEL
 NIKIEL SZCZOTKOWY

FALA

No.	
75485	20/40

PL Korek automatyczny
 GB Pop-up waste
 D Waschbecken stöpsel
 RUS Автоматическая пробка для умывальника
 CZ Automatická zátká
 RO Sifon chiuveta
 H Mosdo lefolyó elzáró
 E Tapón automat. para batería de lado

CLICK - CLACK

EASY TO CLEAN UNDO A PLUG POSSIBILITY

LATWE CZYSZCZENIE MOŻLIWOŚĆ ODKRĘCENIA KÓRKA

G 1 1/4
 UNIVERSAL THREAD
 UNIWERSALNY GWINT

FOR WASH BASIN WITHOUT OVERFLOW DO UMYWALEK BEZ PRZELIWIEM

BRASS
 MOSIADZ

CHROME PLATED
 CHROMOWANY

FALA

No.	
75486	20/40

PL Korek automatyczny
 GB Pop-up waste
 D Waschbecken stöpsel
 RUS Автоматическая пробка для умывальника
 CZ Automatická zátká
 RO Sifon chiuveta
 H Mosdo lefolyo elzaro
 E Tapón automat. para batería de lado



CLICK - CLACK
 EASY TO CLEAN
 ÚNKA-PUSÍRÁS
 LATWE CZYSZCZENIE
 MOŻLIWOŚĆ
 ODKREŚCENIA KÓRKA
 UNIVERSAL THREAD
 UNIWERSALNY
 GWINT
 G 1 1/4



FOR WASH BASIN
 WITH OVERFLOW
 DO UMYWALEK
 Z PRZELEWEM
 BRASS
 MOSIADZ
 CHROME
 PLATED
 CHROMOWANY

FALA

No.	
75487	20/40

PL Korek automatyczny
 GB Pop-up waste
 D Waschbecken stöpsel
 RUS Автоматическая пробка для умывальника
 CZ Automatická zátká
 RO Sifon chiuveta
 H Mosdo lefolyo elzaro
 E Tapón automat. para batería de lado



CLICK - CLACK
 EASY TO CLEAN
 ÚNKA-PUSÍRÁS
 LATWE CZYSZCZENIE
 MOŻLIWOŚĆ
 ODKREŚCENIA KÓRKA
 UNIVERSAL THREAD
 UNIWERSALNY
 GWINT
 G 1 1/4



FOR WASH BASIN
 WITH OVERFLOW
 DO UMYWALEK
 Z PRZELEWEM
 BRASS
 MOSIADZ
 BRUSHED
 NICKEL
 SZCZOTKOWANY

FALA

No.	
75488	20/40

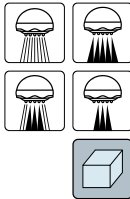

PL Sluchawka prysznicowa
 GB Shower handle
 D Handbrause
 RUS Разбрызгиватель для душа
 CZ Ruční sprcha
 RO Cap duş
 H Kézi zuhanyfej
 E Ducha



FALA

No.	
75540	20/80

PL Sluchawka prysznicowa
 GB Shower handle
 D Handbrause
 RUS Разбрызгиватель для душа
 CZ Ruční sprcha
 RO Cap duş
 H Kézi zuhanyfej
 E Ducha

FALA

No.	
75541	20/80



PL Sluchawka prysznicowa
 GB Shower handle
 D Handbrause
 RUS Разбрызгиватель для душа
 CZ Ruční sprcha
 RO Cap duş
 H Kézi zuhanyfej
 E Ducha



FALA

No.	
75543	12/48

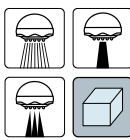
PL Sluchawka prysznicowa
 GB Shower handle
 D Handbrause
 RUS Разбрызгиватель для душа
 CZ Ruční sprcha
 RO Cap duş
 H Kézi zuhanyfej
 E Ducha

FALA

No.	
75545	15/60

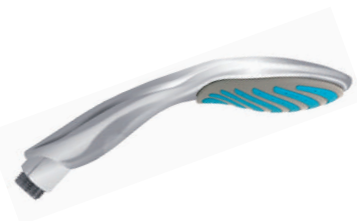

PL Sluchawka prysznicowa
 GB Shower handle
 D Handbrause
 RUS Разбрызгиватель для душа
 CZ Ruční sprcha
 RO Cap duş
 H Kézi zuhanyfej
 E Ducha

FALA

No.	
75549	30/60

PL Sluchawka prysznicowa
 GB Shower handle
 D Handbrause
 RUS Разбрызгиватель для душа
 CZ Ruční sprcha
 RO Cap duş
 H Kézi zuhanyfej
 E Ducha

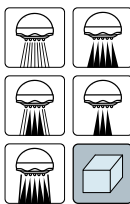
FALA

No.	
75542	30/60

PL Sluchawka prysznicowa
 GB Shower handle
 D Handbrause
 RUS Разбрызгиватель для душа
 CZ Ruční sprcha
 RO Cap duș
 H Kézi zuhanyfej
 E Ducha

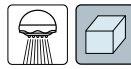

FALA

No.	
75544	15/60

PL Sluchawka prysznicowa
 GB Shower handle
 D Handbrause
 RUS Разбрызгиватель для душа
 CZ Ruční sprcha
 RO Cap duș
 H Kézi zuhanyfej
 E Ducha

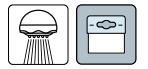

FALA

No.	
75548	30/60

PL Sluchawka prysznicowa
 GB Shower handle
 D Handbrause
 RUS Разбрызгиватель для душа
 CZ Ruční sprcha
 RO Cap duș
 H Kézi zuhanyfej
 E Ducha

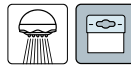

FALA

No.	
75550	30/60

PL Sluchawka prysznicowa
 GB Shower handle
 D Handbrause
 RUS Разбрызгиватель для душа
 CZ Ruční sprcha
 RO Cap duș
 H Kézi zuhanyfej
 E Ducha

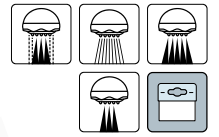

FALA

No.	
75551	30/60

PL Sluchawka prysznicowa
 GB Shower handle
 D Handbrause
 RUS Разбрызгиватель для душа
 CZ Ruční sprcha
 RO Cap duș
 H Kézi zuhanyfej
 E Ducha

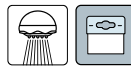

FALA

No.	
75552	30/60

PL Sluchawka prysznicowa
 GB Shower handle
 D Handbrause
 RUS Разбрызгиватель для душа
 CZ Ruční sprcha
 RO Cap duș
 H Kézi zuhanyfej
 E Ducha

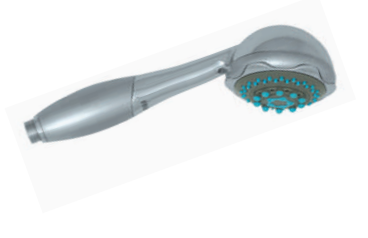
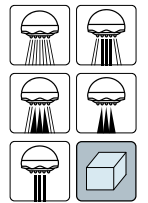

FALA

No.	
75562	50

PL Sluchawka prysznicowa
 GB Shower handle
 D Handbrause
 RUS Разбрызгиватель для душа
 CZ Ruční sprcha
 RO Cap duș
 H Kézi zuhanyfej
 E Ducha

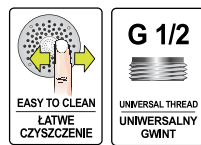

FALA

No.	type	
75627	DELTA	24/48

PL Sluchawka prysznicowa
 GB Shower handle
 D Handbrause
 RUS Разбрызгиватель для душа
 CZ Ruční sprcha
 RO Cap duș
 H Kézi zuhanyfej
 E Ducha

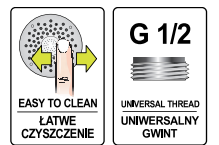

FALA

No.	type	
75629	TUGELA	24/48

PL Słuchawka prysznicowa
 GB Shower handle
 D Handbrause
 RUS Разбрызгиватель для душа
 CZ Ruční sprcha
 RO Cap duș
 H Kézi zuhanyfej
 E Ducha



EASY TO CLEAN
 ŁATWE CZYSZCZENIE

G 1/2
 UNIVERSAL THREAD
 UNIWERSALNY GWINT

FALA

No.	type	
75631	HERMANA	25/50

PL Słuchawka prysznicowa
 GB Shower handle
 D Handbrause
 RUS Разбрызгиватель для душа
 CZ Ruční sprcha
 RO Cap duș
 H Kézi zuhanyfej
 E Ducha

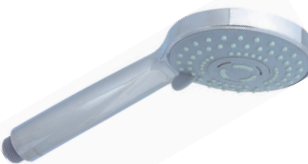

100%
70%
 WATER SAVING
 OSZCZĘDNOŚĆ WODY

EASY TO CLEAN
 ŁATWE CZYSZCZENIE

G 1/2
 UNIVERSAL THREAD
 UNIWERSALNY GWINT

PVC

FALA

No.	type	
75626	KILE	25/50

PL Słuchawka prysznicowa
 GB Shower handle
 D Handbrause
 RUS Разбрызгиватель для душа
 CZ Ruční sprcha
 RO Cap duș
 H Kézi zuhanyfej
 E Ducha



100%
70%
 WATER SAVING
 OSZCZĘDNOŚĆ WODY

EASY TO CLEAN
 ŁATWE CZYSZCZENIE

G 1/2
 UNIVERSAL THREAD
 UNIWERSALNY GWINT

PVC

FALA

No.	type	
75625	DETIFOS	25/50

PL Słuchawka prysznicowa
 GB Shower handle
 D Handbrause
 RUS Разбрызгиватель для душа
 CZ Ruční sprcha
 RO Cap duș
 H Kézi zuhanyfej
 E Ducha



100%
70%
 WATER SAVING
 OSZCZĘDNOŚĆ WODY

EASY TO CLEAN
 ŁATWE CZYSZCZENIE

G 1/2
 UNIVERSAL THREAD
 UNIWERSALNY GWINT

PVC

FALA

No.	type	
75624	SALTO	25/50

PL Słuchawka prysznicowa
 GB Shower handle
 D Handbrause
 RUS Разбрызгиватель для душа
 CZ Ruční sprcha
 RO Cap duș
 H Kézi zuhanyfej
 E Ducha



SOFT TOUCH
 PRZYJEMNY W DOTYKU

100%
70%
 WATER SAVING
 OSZCZĘDNOŚĆ WODY

EASY TO CLEAN
 ŁATWE CZYSZCZENIE

G 1/2
 UNIVERSAL THREAD
 UNIWERSALNY GWINT

PVC

FALA

No.	type	
75620	SALTO	25/50

PL Słuchawka prysznicowa
 GB Shower handle
 D Handbrause
 RUS Разбрызгиватель для душа
 CZ Ruční sprcha
 RO Cap duș
 H Kézi zuhanyfej
 E Ducha



SOFT TOUCH
 PRZYJEMNY W DOTYKU

100%
70%
 WATER SAVING
 OSZCZĘDNOŚĆ WODY

EASY TO CLEAN
 ŁATWE CZYSZCZENIE

G 1/2
 UNIVERSAL THREAD
 UNIWERSALNY GWINT

PVC

FALA

No.	type	
75621	SALTO	25/50

PL Słuchawka prysznicowa
 GB Shower handle
 D Handbrause
 RUS Разбрызгиватель для душа
 CZ Ruční sprcha
 RO Cap duș
 H Kézi zuhanyfej
 E Ducha



SOFT TOUCH
 PRZYJEMNY W DOTYKU

100%
70%
 WATER SAVING
 OSZCZĘDNOŚĆ WODY

EASY TO CLEAN
 ŁATWE CZYSZCZENIE

G 1/2
 UNIVERSAL THREAD
 UNIWERSALNY GWINT

PVC

FALA

No.	type	
75622	SALTO	25/50

PL Słuchawka prysznicowa
 GB Shower handle
 D Handbrause
 RUS Разбрызгиватель для душа
 CZ Ruční sprcha
 RO Cap duș
 H Kézi zuhanyfej
 E Ducha



SOFT TOUCH
 PRZYJEMNY W DOTYKU

100%
70%
 WATER SAVING
 OSZCZĘDNOŚĆ WODY

EASY TO CLEAN
 ŁATWE CZYSZCZENIE

G 1/2
 UNIVERSAL THREAD
 UNIWERSALNY GWINT

PVC

FALA

No.	type	
75623	SALTO	25/50

PL Uchwyt do słuchawki prysznicowej
 GB Shower holder
 D Brauseportler
 RUS Держатель души
 CZ ' UCHWYT DO SŁUCHAWKI PRYSZNICOWEJ
 RO Suport pt. dus
 H Zuhanycső tartó
 E Grifo para ducha



FALA

No.		
75564		50/200

PL Uchwyt do słuchawki prysznicowej
 GB Shower holder
 D Brauseportler
 RUS Держатель души
 CZ ' UCHWYT DO SŁUCHAWKI PRYSZNICOWEJ
 RO Suport pt. dus
 H Zuhanycső tartó
 E Grifo para ducha



FALA

No.		
75565		30/180

PL Wąż prysznicowy
 GB Shower hose
 D Brausenschlauch
 RUS Шланг для душа

CZ Sprchová hadice
 RO Furtun duș
 H Zuhanycső
 E Manguera de ducha

G 1/2 G 12.5 mm

STAINLESS STEEL



FALA

No.	L (m)	
75553	1.5	30/60
75554	1.7	30/60

PL Wąż prysznicowy
 GB Shower hose
 D Brausenschlauch
 RUS Шланг для душа

CZ Sprchová hadice
 RO Furtun duș
 H Zuhanycső
 E Manguera de ducha

POLISHED STAINLESS STEEL STAL NIEROZŻYWA POLEROWANA

150-200 cm EXTENSIBLE ROZCIĄGLIWY

SWIVEL NUT OBROTOWA KONCÓWKA

DOUBLE WEAVE PODWÓJNY SPLIT

G 1/2

UNIVERSAL THREAD UNIWERSALNY GWINT



FALA

No.	L (m)	
75574	1.5-2.0	24

PL Wąż prysznicowy
 GB Shower hose
 D Brausenschlauch
 RUS Шланг для душа

CZ Sprchová hadice
 RO Furtun duș
 H Zuhanycső
 E Manguera de ducha

CHROME PLATED CHROMOWANY

TENSILE RESISTANCE WYTRZYMAŁY NA ROZCIĄGANIE

SWIVEL NUT OBROTOWA KONCÓWKA

DOUBLE WEAVE PODWÓJNY SPLIT

G 1/2

UNIVERSAL THREAD UNIWERSALNY GWINT



FALA

No.	L (m)	
75572	1.5	24
75573	2.0	24

PL Wąż prysznicowy
 GB Shower hose
 D Brausenschlauch
 RUS Шланг для душа

CZ Sprchová hadice
 RO Furtun duș
 H Zuhanycső
 E Manguera de ducha

G 1/2 G 12.5 mm

BRASS WITH EPDM MOSIĄDZ Z EPDM

DOUBLE LOCKED HOSE PODWÓJNA KONSTRUKCJA WĘŻA

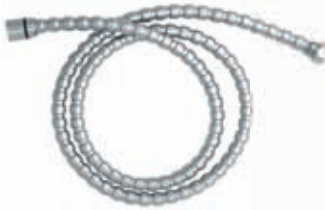

FALA

No.	L (m)	
75570	1.5	30/60

PL Wąż prysznicowy
 GB Shower hose
 D Brausenschlauch
 RUS Шланг для душа

CZ Sprchová hadice
 RO Furtun duș
 H Zuhanycső
 E Manguera de ducha

NON TWISTING NIE SKRĘCA SIĘ

FLEXIBLE ELASTYCZNY

EASY TO CLEAN ŁATWY W UTRZYMANIU CZYSTOŚCI

SWIVEL NUT OBROTOWA KONCÓWKA

G 1/2

UNIVERSAL THREAD UNIWERSALNY GWINT



FALA

No.	L (m)	
75596	1.5	24
75597	2.0	24

PL Wąż prysznicowy
 GB Shower hose
 D Brausenschlauch
 RUS Шланг для душа

CZ Sprchová hadice
 RO Furtun duș
 H Zuhanycső
 E Manguera de ducha

G 1/2 G 12.5 mm

NO STICK NIE ZAGINA SIĘ



FALA

No.	L (m)	
75571	1.7	25/50

PL Wąż prysznicowy
GB Shower hose
D Brausenschlauch
RUS Шланг для душа

CZ Sprchová hadice
RO Furtun duș
H Zuhanycső
E Manguera de ducha

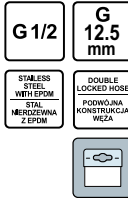

FALA

No.	L (m)	
75578	1.5	30/60
75579	1.7	30/60

PL Wąż prysznicowy
GB Shower hose
D Brausenschlauch
RUS Шланг для душа

CZ Sprchová hadice
RO Furtun duș
H Zuhanycső
E Manguera de ducha



FALA

No.	L (m)	
75598	1.5	24
75599	2.0	24

PL Wąż prysznicowy
GB Shower hose
D Brausenschlauch
RUS Шланг для душа

CZ Sprchová hadice
RO Furtun duș
H Zuhanycső
E Manguera de ducha



FALA

No.	L (m)	
75594	1.5	24
75595	2.0	24

PL Wąż przyłączeniowy elastyczny
GB Flexible connecting hose
D Edelstahl flexschlauch
RUS Гибкий шланг для смесителя
CZ Flexibilní nerezové hadice na vodu
RO Racorduri flexibile pt. apa
H Rugalmas rozsdamentes acél cső a víz
E Manguera flexible de acero inoxidable para el agua

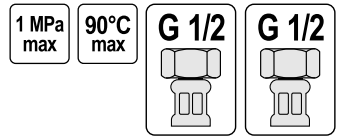

FALA

No.	L (mm)	
71800	300	10/250
71801	400	10/200
71802	500	10/160
71803	600	10/150
71804	800	10/100
71805	1000	10/80

PL Wąż przyłączeniowy elastyczny
GB Flexible connecting hose
D Edelstahl flexschlauch
RUS Гибкий шланг для смесителя
CZ Flexibilní nerezové hadice na vodu
RO Racorduri flexibile pt. apa
H Rugalmas rozsdamentes acél cső a víz
E Manguera flexible de acero inoxidable para el agua

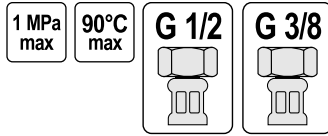

FALA

No.	L (mm)	
71807	300	10/300
71808	400	10/250
71809	500	10/200
71810	600	10/150
71811	800	10/100
71812	1000	10/80

PL Wąż przyłączeniowy elastyczny
GB Flexible connecting hose
D Edelstahl flexschlauch
RUS Гибкий шланг для смесителя
CZ Flexibilní nerezové hadice na vodu
RO Racorduri flexibile pt. apa
H Rugalmas rozsdamentes acél cső a víz
E Manguera flexible de acero inoxidable para el agua

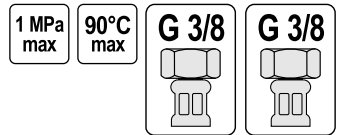

FALA

No.	L (mm)	
71814	300	10/300
71815	400	10/250
71816	500	10/200
71817	600	10/150
71818	800	10/100
71819	1000	10/80

PL Waż przyłączeniowy elastyczny
 GB Flexible connecting hose
 D Edelstahl flexschlauch
 RUS Гибкий шланг для смесителя
 CZ Flexibilní nerezové hadice na vodu
 RO Racorduri flexibile pt. apa
 H Rugalmas rozsdamentes acél cső a víz
 E Manguera flexible de acero inoxidable para el agua

1 MPa max 90°C max G 1/2 G 1/2

FALA

No.	L (mm)	☐
71820	300	10/250
71821	400	10/200
71822	500	10/160
71823	600	10/150
71824	800	10/100
71825	1000	10/80

PL Waż przyłączeniowy elastyczny
 GB Flexible connecting hose
 D Edelstahl flexschlauch
 RUS Гибкий шланг для смесителя
 CZ Flexibilní nerezové hadice na vodu
 RO Racorduri flexibile pt. apa
 H Rugalmas rozsdamentes acél cső a víz
 E Manguera flexible de acero inoxidable para el agua

1 MPa max 90°C max G 1/2 G 3/8

FALA

No.	L (mm)	☐
71827	300	10/300
71828	400	10/250
71829	500	10/200
71830	600	10/150
71831	800	10/100
71832	1000	10/80

PL Waż przyłączeniowy elastyczny
 GB Flexible connecting hose
 D Edelstahl flexschlauch
 RUS Гибкий шланг для смесителя
 CZ Flexibilní nerezové hadice na vodu
 RO Racorduri flexibile pt. apa
 H Rugalmas rozsdamentes acél cső a víz
 E Manguera flexible de acero inoxidable para el agua

1 MPa max 90°C max G 3/8 G 3/8

FALA

No.	L (mm)	☐
71833	300	10/300
71834	400	10/250
71835	500	10/200
71836	600	10/150
71837	800	10/100
71838	1000	10/80

PL Waż przyłączeniowy elastyczny
 GB Flexible connecting hose
 D Edelstahl flexschlauch
 RUS Гибкий шланг для смесителя
 CZ Flexibilní nerezové hadice na vodu
 RO Racorduri flexibile pt. apa
 H Rugalmas rozsdamentes acél cső a víz
 E Manguera flexible de acero inoxidable para el agua

1 MPa max 90°C max G 1/2 M 10 17 mm

FALA

No.	L (mm)	☐
71840	300	10/300
71841	400	10/250
71842	500	10/200
71843	600	10/150
71844	800	10/100

PL Waż przyłączeniowy elastyczny
 GB Flexible connecting hose
 D Edelstahl flexschlauch
 RUS Гибкий шланг для смесителя
 CZ Flexibilní nerezové hadice na vodu
 RO Racorduri flexibile pt. apa
 H Rugalmas rozsdamentes acél cső a víz
 E Manguera flexible de acero inoxidable para el agua

1 MPa max 90°C max G 1/2 M 10 50 mm

FALA

No.	L (mm)	☐
71846	300	10/300
71847	400	10/250
71848	500	10/200
71849	600	10/150
71850	800	10/100

PL Waż przyłączeniowy elastyczny
 GB Flexible connecting hose
 D Edelstahl flexschlauch
 RUS Гибкий шланг для смесителя
 CZ Flexibilní nerezové hadice na vodu
 RO Racorduri flexibile pt. apa
 H Rugalmas rozsdamentes acél cső a víz
 E Manguera flexible de acero inoxidable para el agua

1 MPa max 90°C max G 3/8 M 10 17 mm

FALA

No.	L (mm)	☐
71851	300	10/300
71852	400	10/300
71853	500	10/200
71854	600	10/150
71855	800	10/100

- PL Wąż przyłączeniowy elastyczny
- GB Flexible connecting hose
- D Edelstahl flexschlauch
- RUS Гибкий шланг для смесителя
- CZ Flexibilní nerezové hadice na vodu
- RO Racorduri flexibile pt. apa
- H Rugalmas rozsdamentes acél cső a víz
- E Manguera flexible de acero inoxidable para el agua

1 MPa
max

90°C
max

G 3/8

M 10
50 mm

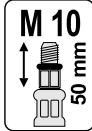
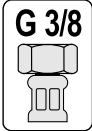

FALA

No.	L (mm)	
71856	300	10/300
71857	400	10/300
71858	500	10/200
71859	600	10/150
71860	800	10/100

- PL Zestaw łazienkowy
- GB Bathroom set
- D Brausegarnitur
- RUS Набор для душевой
- CZ Sprchová souprava
- RO Set pt. dus
- H Zuhanyzó készlet
- E Juego de baño ducha

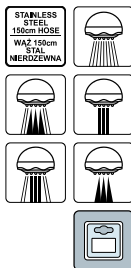

FALA

No.	
75556	12

- PL Zestaw łazienkowy
- GB Bathroom set
- D Brausegarnitur
- RUS Набор для душевой
- CZ Konzole na sprchu
- RO Suport dus
- H Zuhanyzó tartó rúd
- E Carril de ducha



FALA

No.	
75559	16

- PL Zestaw łazienkowy
- GB Bathroom set
- D Brausegarnitur
- RUS Набор для душевой
- CZ Sprchová souprava
- RO Set pt. dus
- H Zuhanyzó készlet
- E Juego de baño ducha



FALA

No.	
75555	12

- PL Zestaw łazienkowy
- GB Bathroom set
- D Brausegarnitur
- RUS Набор для душевой
- CZ Sprchová souprava
- RO Set pt. dus
- H Zuhanyzó készlet
- E Juego de baño ducha

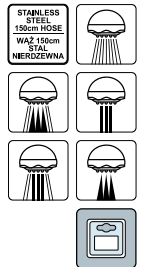

FALA

No.	
75557	12

- PL Zestaw łazienkowy
- GB Bathroom set
- D Brausegarnitur
- RUS Набор для душевой
- CZ Sprchová souprava
- RO Set pt. dus
- H Zuhanyzó készlet
- E Juego de baño ducha



FALA

No.	
75558	12

- PL Zestaw łazienkowy
- GB Bathroom set
- D Brausegarnitur
- RUS Набор для душевой
- CZ Sprchová souprava
- RO Set pt. dus
- H Zuhanyzó készlet
- E Juego de baño ducha





FALA

No.	
75660	5

PL Zestaw łazienkowy
 GB Bathroom set
 D Brausegarnitur
 RUS Набор для душевой
 CZ Sprchová souprava
 RO Set pt. dus
 H Zuhanyzó készlet
 E Juego de baño ducha



EASY CLEAN
ŁATWE CZYSZCZENIE





FALA

No.		
75661		5

PL Wieszak na ręczniki
 GB Towel bar
 D Handtuchring
 RUS Вешалка для полотенец

CZ Věšák na ručník tyčový
 RO Suport prosop
 H Torlókozó tartó
 E Toallero cromado



CHROME PLATED BRASS
CHROMOWANY MOSIADZ



FALA

No.	cm	type	
75855	50	IMPRESSION	20

PL Mata antypoślizgowa
 GB Anti-slip mat
 D Anti-rutsch-matte
 RUS Противоскользящий коврик
 CZ 3URMNOJ RM SROBAND
 RO Mat anti-alunecare
 H Csúszásgátló lábtörő
 E Alfombra antideslizante



ANTI-SLIP
ANTYPOŚLIZGOWA



38.5 cm
69 cm



FALA

No.	size / rozmiar (cm)	
75910	69x38.5	24

PL Mata antypoślizgowa
 GB Anti-slip mat
 D Anti-rutsch-matte
 RUS Противоскользящий коврик
 CZ 3URMNOJ RM SROBAND
 RO Mat anti-alunecare
 H Csúszásgátló lábtörő
 E Alfombra antideslizante



ANTI-SLIP
ANTYPOŚLIZGOWA



38.5 cm
69 cm



FALA

No.	size / rozmiar (cm)	
75911	69x38.5	24

PL Mata antypoślizgowa
 GB Anti-slip mat
 D Anti-rutsch-matte
 RUS Противоскользящий коврик
 CZ 3URMNOJ RM SROBAND
 RO Mat anti-alunecare
 H Csúszásgátló lábtörő
 E Alfombra antideslizante



ANTI-SLIP
ANTYPOŚLIZGOWA



38.5 cm
69 cm



FALA

No.	size / rozmiar (cm)	
75912	69x38.5	24

PL Mata antypoślizgowa
 GB Anti-slip mat
 D Anti-rutsch-matte
 RUS Противоскользящий коврик
 CZ 3URMNOJ RM SROBAND
 RO Mat anti-alunecare
 H Csúszásgátló lábtörő
 E Alfombra antideslizante

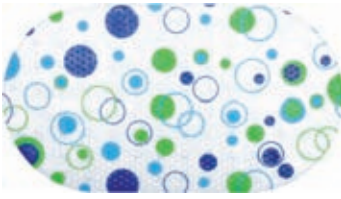

ANTI-SLIP
ANTYPOŚLIZGOWA



38.5 cm
69 cm



FALA

No.	size / rozmiar (cm)	
75913	69x38.5	24

PL Mata antypoślizgowa
 GB Anti-slip mat
 D Anti-rutsch-matte
 RUS Противоскользящий коврик
 CZ 3URMNOJ RM SROBAND
 RO Mat anti-alunecare
 H Csúszásgátló lábtörő
 E Alfombra antideslizante

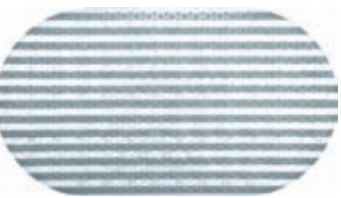

ANTI-SLIP
ANTYPOŚLIZGOWA



38.5 cm
69 cm



FALA



No.	size / rozmiar (cm)	
75914	69x38.5	24

PL Zaslonka prysznicowa
 GB Shower curtain
 D Duschvorhang
 RUS Занавеска для душа
 CZ Sprchový závěs
 RO Perdea dus
 H Zuhanyfüggöny
 E Cortina de ducha



POLYESTER
POLIESTER

180 cm
200 cm

FALA

No.	size / rozmiar (cm)	
75970	180x200	24

PL Zastlonka prysznicowa
 GB Shower curtain
 D Duschvorhang
 RUS Занавеска для душа
 CZ Sprchový závěs
 RO Perdea duș
 H Zuhanyfüggöny
 E Cortina de ducha



POLYESTER
 POLYESTER

180 cm
200 cm



FALA

No.	size / rozmiar (cm)	
75971	180x200	24

PL Zastlonka prysznicowa
 GB Shower curtain
 D Duschvorhang
 RUS Занавеска для душа
 CZ Sprchový závěs
 RO Perdea duș
 H Zuhanyfüggöny
 E Cortina de ducha



POLYESTER
 POLYESTER

180 cm
200 cm



FALA

No.	size / rozmiar (cm)	
75972	180x200	24

PL Zastlonka prysznicowa
 GB Shower curtain
 D Duschvorhang
 RUS Занавеска для душа
 CZ Sprchový závěs
 RO Perdea duș
 H Zuhanyfüggöny
 E Cortina de ducha



POLYESTER
 POLYESTER

180 cm
200 cm



FALA

No.	size / rozmiar (cm)	
75973	180x200	24

PL Zastlonka prysznicowa
 GB Shower curtain
 D Duschvorhang
 RUS Занавеска для душа
 CZ Sprchový závěs
 RO Perdea duș
 H Zuhanyfüggöny
 E Cortina de ducha

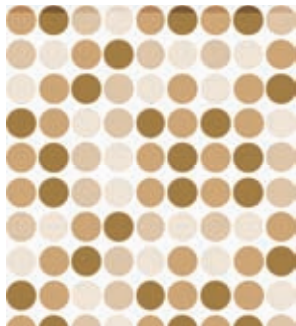

PEVA
 MATERIAL
 MATERIAL

180 cm
200 cm



FALA

No.	size / rozmiar (cm)	
75974	180x200	24

PL Zastlonka prysznicowa
 GB Shower curtain
 D Duschvorhang
 RUS Занавеска для душа
 CZ Sprchový závěs
 RO Perdea duș
 H Zuhanyfüggöny
 E Cortina de ducha



PEVA
 MATERIAL
 MATERIAL

180 cm
200 cm



FALA

No.	size / rozmiar (cm)	
75975	180x200	24

PL Zastlonka prysznicowa
 GB Shower curtain
 D Duschvorhang
 RUS Занавеска для душа
 CZ Sprchový závěs
 RO Perdea duș
 H Zuhanyfüggöny
 E Cortina de ducha



PEVA
 MATERIAL
 MATERIAL

180 cm
200 cm



FALA

No.	size / rozmiar (cm)	
75976	180x200	24

PL Drażek prysznicowy
 GB Curtain rod
 D Gardinenstange
 RUS Карниз для штор в ванну
 CZ Závěs tyč
 RO Cortina tijă
 H Fűggönyrúd
 E Barra para cortina de ducha



RANGE
 ROZPIĘTOŚĆ

RANGE
 ROZPIĘTOŚĆ

FALA

No.	range / rozpiętość (cm)	
75990	90-160	24
75991	110-200	24

PL Drażek prysznicowy
 GB Curtain rod
 D Gardinenstange
 RUS Карниз для штор в ванну
 CZ Závěs tyč
 RO Cortina tijă
 H Fűggönyrúd
 E Barra para cortina de ducha



RANGE
 ROZPIĘTOŚĆ

RANGE
 ROZPIĘTOŚĆ

FALA

No.	range / rozpiętość (cm)	
75992	90-160	24
75993	110-200	24

- PL Deska sedesowa
- GB Toilet seat
- D WC Deckel
- RUS Сиденье для унитаза
- CZ WC sedátko
- RO Capac WC
- H WC-ülőke
- E Asiento de inodoro



FALA

No.		
75470		6



- STAINLESS STEEL HINGES
MOCOWANE ZE STALI NIERDZEWNEJ
- UNIVERSAL SIZE
UNIVERSALNY ROZMIAR
- SLOW CLOSE
WOLNE OPADANIE
- 360°
ECCENTRIC ASSEMBLY
MIMOŚRODOWY MONTAŻ
- EASY TO CLEAN
LATE CZYSZCZENIE



SLOW CLOSE / WOLNE OPADANIE

- PL Nakładka toaletowa na WC
- GB Soft baby toilet seat
- D WC Deckel
- RUS Крышка на унитаз
- CZ WC sedátko
- RO Capac WC
- H WC-ülőke
- E Asiento de váter

300 mm

PCV



FALA

No.	mm	
75482	300	12

- PL Stolek plastikowy
- GB Plastic stool
- D Kunststoff Hocker
- RUS Пластиковый табурет
- CZ Plastová stolička
- RO Scaun de plastic
- H Műanyag széklét
- E Taburete de plástico

FALA

No.		
75920		10



- 4 SENSORS
PRECYZYJNA TECHNIKA POMIARU
WYSOKOPRECYZYJNE
TENZOMETRYCZNYCH
- 5-150 kg
11-330 lb
- LCD DISPLAY
WYŚWIETLACZ LCD
- 300x300 mm
TEMPERED GLASS
SZKŁO HARTOWANE
- kg/lb/st
- OVERLOAD DETECTOR
WSKAZNIK PRZEŁADZENIA
- AUTO POWER ON/OFF
AUTOMATYCZNE WYŁĄCZANIE
- POWER ZASILANIE
3V
2xAAA
- AUTO ZERO
AUTOMATYCZNE KALIBROWANIE
- LOW BATTERY INDICATOR
WSKAZNIK NISZAKOJĄCEGO POZIOMU BATERII



- PL Stolek plastikowy
- GB Plastic stool
- D Kunststoff Hocker
- RUS Пластиковый табурет
- CZ Plastová stolička
- RO Scaun de plastic
- H Műanyag széklét
- E Taburete de plástico



FALA

No.	size / rozmiar (cm)	
75915	30x20x21	10/20

- PL Stolek plastikowy
- GB Plastic stool
- D Kunststoff Hocker
- RUS Пластиковый табурет
- CZ Plastová stolička
- RO Scaun de plastic
- H Műanyag széklét
- E Taburete de plástico



FALA

No.	size / rozmiar (cm)	
75916	30x20x21	10/20

- PL Pistolet do udrażniania rur
- GB Drain cleaner
- D Pistole zum Reinigen von Röhren
- RUS Пистолет для прочистки труб
- CZ Pistole na čištění trubek
- RO Pistol pt. curățarea țevilor
- H Csőlisztító pisztoly
- E Pistola desatapaños

135mm



VOREL



No.	Ø (mm)	
55500	135	10

- PL Pompa do udrażniania kanalizacji
- GB Drain suction pump
- D Hochdruck-Rohrreiner
- RUS Ручной насос для прочистки труб
- CZ Čerpadlo na čištění trubek
- RO Pompă pt. curățarea țevilor
- H Csőlisztító szivattyú
- E El desague del fregadero limpiador



VOREL



No.	Ø (mm)	
55505	65; 155	24



No.	Page	No.	Page	No.	Page	No.	Page	No.	Page	No.	Page	No.	Page	No.	Page
00300	124	05100	96	06351	134	06974	90	07976	82	08582	102	09006	136	09422	140
00320	124	05300	144	06360	133	06975	90	07977	82	08585	102	09010	137	09425	140
00500	124	05301	145	06370	134	06976	90	07978	82	08630	81	09015	137	09427	140
00510	124	05302	145	06380	134	06977	91	07984	82	08631	81	09017	137	09429	140
00600	124	05311	145	06388	144	06978	91	07985	82	08633	81	09025	137	09430	140
00610	124	05312	145	06390	144	06979	91	07986	82	08635	81	09028	137	09457	142
00703	124	05540	77	06391	144	06980	91	07987	82	08636	81	09036	137	09459	142
01060	124	05560	77	06392	144	06981	91	07988	82	08638	81	09038	137	09462	142
02300	124	05580	77	06393	144	06982	91	08170	81	08639	81	09040	137	09463	142
02400	124	05600	77	06394	144	06983	91	08171	81	08640	81	09044	137	09465	253
03150	125	05901	135	06395	144	06985	91	08174	81	08641	81	09046	137	09466	253
03160	125	05902	135	06396	144	06986	91	08175	81	08642	81	09048	137	09467	253
03220	125	05903	135	06397	144	06987	91	08177	81	08644	81	09049	137	09470	142: 254
03221	125	05904	135	06398	144	06988	91	08185	81	08646	81	09050	137	09471	142: 254
03240	76	05905	135	06399	144	06989	91	08186	81	08655	81	09051	137	09475	142: 253
03241	76	05906	135	06400	131	06990	91	08188	81	08656	81	09054	137	09476	142: 253
03245	76	05911	135	06401	132	06992	91	08190	81	08658	81	09056	137	09477	142: 253
03246	76	05912	135	06410	131	06993	92	08191	81	08663	81	09060	136	09478	142: 253
03300	77	05913	135	06420	131	06994	92	08193	81	08665	81	09063	138	09480	254
03301	77	05914	135	06430	131	06995	92	08200	82	08669	81	09065	138	09481	254
03900	127	05915	135	06440	131	07060	100	08201	82	08671	82	09080	136	09482	254
03920	127	05916	135	06450	138	07080	100	08203	82	08672	82	09090	136	09486	254
03940	127	05921	135	06452	138	07100	100	08288	101	08674	82	09094	138	09487	254
03950	127	05922	135	06453	138	07120	100	08289	101	08681	82	09100	116	09489	254
03990	76	05923	135	06470	132	07180	100	08290	101	08683	82	09130	116	09490	254
04000	125	05924	135	06472	132	07240	100	08291	101	08710	79	09150	116	09521	140
04001	125	05925	135	06500	132	07320	100	08292	101	08711	79	09160	116	09522	140
04020	125	05926	135	06510	132	07400	100	08293	101	08712	79	09170	116	09523	140
04022	125	06030	134	06512	133	07506	100	08300	92	08714	79	09171	117	09524	140
04050	127	06040	134	06520	132	07508	100	08312	92	08715	79	09172	117	09525	140
04100	127	06050	134	06530	132	07510	100	08314	92	08731	80	09173	117	09531	140
04130	126	06060	134	06532	133	07512	100	08315	92	08732	80	09180	145	09532	140
04131	126	06080	134	06537	133	07530	100	08316	92	08734	80	09190	145	09533	140
04200	125	06100	134	06538	133	07540	100	08318	92	08735	80	09220	140	09534	140
04210	125	06110	134	06540	132	07560	100	08350	93	08751	80	09302	139	09535	140
04300	40: 115	06120	134	06640	132	07580	100	08400	93	08752	80	09303	139	09536	140
04400	126	06130	134	06650	133	07610	100	08410	93	08754	80	09307	138	09537	140
04405	126	06140	134	06660	132	07620	100	08450	93	08755	80	09308	138	09560	141
04406	126	06150	134	06670	133	07630	100	08500	93	08770	82	09310	139	09561	141
04407	126	06290	134	06680	132	07650	100	08501	93	08771	82	09311	139	09562	141
04410	126	06294	135	06690	133	07651	101	08510	93	08773	82	09331	139	09581	141
04500	127	06295	135	06700	133	07652	101	08511	93	08780	80	09332	139	09583	141
04510	127	06296	135	06701	133	07664	101	08520	93	08781	80	09334	138	09585	141
04540	128	06297	135	06740	133	07665	101	08521	93	08782	80	09336	138	09587	141
04542	128	06298	135	06760	133	07666	101	08522	93	08783	80	09338	139	09589	141
04544	128	06299	135	06780	133	07667	101	08533	102	08785	80	09345	138	09636	141
04546	128	06300	135	06781	133	07668	101	08534	102	08786	80	09346	138	09638	141
04561	253	06301	135	06795	136	07879	101	08536	102	08787	80	09359	138	09640	141
04562	253	06302	135	06796	136	07880	101	08538	102	08788	80	09363	139	09642	141
04600	128	06303	135	06797	136	07881	101	08540	102	08790	80	09365	139	09647	141
04610	128	06304	135	06820	96	07882	101	08542	102	08791	80	09370	139	09648	141
04620	128	06305	135	06840	97	07883	101	08545	102	08792	80	09371	139	09649	141
04630	128	06306	135	06860	97	07884	101	08553	102	08793	80	09372	139	09650	141
04640	128	06307	135	06930	90	07885	101	08554	102	08860	83	09373	139	09651	141
04650	128	06308	135	06940	90	07886	101	08556	102	08861	83	09375	139	09653	141
04660	128	06309	135	06950	90	07891	101	08558	102	08864	83	09377	139	09920	141
04668	128	06310	135	06960	90	07894	101	08560	102	08865	83	09378	139	09930	141
04670	128	06320	135	06963	90	07920	102	08562	102	08868	83	09385	140	09950	141
04675	128	06330	135	06964	90	07950	102	08565	102	08869	83	09390	140	10000	254
04700	128	06331	135	06965	90	07960	102	08573	102	08872	83	09395	140	10001	254
04710	128	06335	136	06970	90	07962	102	08574	102	08873	83	09400	144	10002	254
04720	129	06340	133	06971	90	07970	102	08576	102	08875	83	09406	140	10003	255
04721	129	06341	134	06972	90	07974	82	08578	102	08876	83	09408	140	10004	255
05050	97	06350	133	06973	90	07975	82	08580	102	09005	136	09421	140	10005	255

No.	Page	No.	Page	No.	Page	No.	Page	No.	Page	No.	Page	No.	Page	No.	Page
10010	254	16555	157	20700	71	23314	72	23602	75	24530	78	25518	57	28740	85; 319; 327
10011	254	16556	157	20800	71	23315	72	23603	75	24540	78	25519	57	28745	85; 319; 328
10012	254	16557	157	20850	71	23316	72	23604	75	24550	78	25520	57	28746	86; 319; 327
10013	255	17300	155	20900	71	23317	72	23605	75	24570	78	25521	57	28750	85; 319; 327
10014	255	17470	153	21000	71	23318	72	23606	75	24590	78	25530	57	28755	86; 319; 327
10015	255	17471	153	21100	71	23319	72	23608	75	24610	78	25700	57	28757	86; 319; 327
10101	150	17473	153	21200	71	23320	72	23620	74	24630	78	25830	97	28771	86; 319; 328
10104	150	17474	153	21250	71	23321	72	23640	74	24650	78	25860	98	28772	86; 319; 328
10106	150	17480	153	21300	71	23324	72	23650	74	24670	78	25880	98	28773	86; 319; 328
10109	150	17481	153	21400	71	23325	72	23660	74	24700	78	26150	100	28775	86; 319; 328
10111	150	17483	153	21600	71	23326	72	23670	74	24710	78	26200	100	28790	87
10122	150	17484	153	21900	72	23327	72	23680	74	24730	79	26210	100	29000	87
10123	150	17488	152	21905	72	23328	72	23690	74	24740	79	27000	86	29050	87
10125	150	17489	152	21910	72	23329	72	23692	74	24750	79	27100	86	29090	89
10128	150	17490	152	21915	72	23331	73	23693	74	24800	79	27200	86	29100	89
10129	150	17495	152	21918	72	23371	74	23694	74	24810	79	27322	87	29210	87
10130	150	17500	152	21919	72	23372	74	23710	74	24813	79	27495	87	29220	87
10133	150	17501	152	21921	72	23373	74	23720	74	24820	79	27500	88	29311	87
10135	150	17505	152	21924	72	23374	74	23722	74	24823	79	27501	88	29312	87
10138	150	17507	152	21927	72	23375	74	23723	74	24900	78	27502	88	29313	88
10139	150	17508	152	21929	72	23376	74	23724	74	24940	78	27505	88	29317	88
11603	150	17606	157	21932	72	23377	74	23730	74	24950	78	27506	88	29318	88
11605	150	17608	157	21934	72	23378	74	23740	74	24960	78	27510	88	29319	88
11608	150	17610	157	21936	72	23379	74	23750	74	24961	78	27511	88	29323	88
12100	150	17612	157	21938	72	23380	74	23752	74	24962	78	27513	88	29992	55
12200	150	17615	157	21941	72	23381	74	23800	74	24963	78	27520	88	29993	55
12300	150	17620	157	21944	72	23382	74	23820	74	24964	78	27540	126	29994	55
12500	150	17700	131; 314	21948	72	23383	74	23830	74	24965	78	27575	80	29995	55
12502	150	17703	131; 314	21950	72	23390	74	23832	74	24966	78	27600	87	29996	55
12503	150	18200	155	21951	72	23391	74	23840	74	25130	98	27800	88	29997	55
13200	150	18201	155	21952	72	23392	74	23850	74	25150	98	27810	89	30010	54
13300	150	18250	155	21955	72	23393	74	23860	74	25160	98	27811	89	30020	54
13500	150	18300	155	21956	72	23394	74	23862	74	25161	98	27812	89	30030	54
14100	150	18350	155	21957	72	23395	74	23880	74	25162	98	27813	89	30040	54
14200	150	18360	155	21958	72	23396	74	23882	74	25163	98	27814	89	30050	54
14300	150	18361	155	21961	72	23397	74	23883	74	25164	98	27815	89	30060	54
14500	150	18362	155	21963	72	23398	74	23920	74	25165	99	27820	89	30080	54
15004	151	18501	155	21966	72	23399	74	23930	74	25166	99	27830	89	30100	54
15005	151	18502	155	21998	72	23400	74	23932	74	25170	99	27831	89	30150	54
15006	151	18503	155	21999	72	23401	74	23960	74	25171	99	27832	89	30200	54
15007	151	18504	155	22130	71	23402	74	23962	74	25172	99	27833	89	30310	54
15010	151	18797	155	22180	71	23403	74	23980	74	25173	100	27834	89	30320	54
15020	151	18798	155	22190	71	23411	74	23982	74	25230	100	28000	86	30330	54
15050	151	18799	155	22250	71	23412	74	23988	74	25351	99	28010	86	30340	54
15070	151	18800	155	22300	71	23413	74	23990	74	25352	99	28011	86	30350	54
15071	151	18810	155	22310	71	23414	74	23992	74	25353	99	28012	86	30360	54
15072	151	19750	155	22330	71	23415	74	23999	74	25360	99	28380	85	30380	54
15100	151	19770	156	22340	71	23416	74	24000	79	25370	99	28381	85	30390	54
15110	151	20100	71	22350	73	23417	74	24295	79	25380	99	28382	85	30395	54
15130	151	20150	71	22380	73	23418	74	24300	77	25390	99	28385	85	30400	54
15200	151	20200	71	22381	73	23419	74	24310	77	25400	216	28386	85	30410	54
15220	151	20250	71	22460	73	23420	74	24320	77	25410	216	28387	85	30420	54
15240	152	20280	71	22465	73	23421	74	24330	77	25411	216	28394	85	30430	54
16000	157	20300	71	22466	73	23422	74	24340	77	25412	216	28395	85	30440	54
16001	157	20320	71	22500	73	23423	74	24350	77	25450	216	28640	320; 328	30450	54
16002	157	20350	71	22550	79	23424	74	24370	78	25500	57	28641	320; 328	30460	54
16340	156	20400	71	22551	79	23540	72	24390	78	25510	57	28642	320; 328	30480	54
16360	156	20420	71	22565	76	23585	75	24410	78	25511	57	28650	86	30500	54
16380	156	20430	71	22570	76	23586	76	24430	78	25512	57	28680	77	30510	54
16400	156	20450	71	22571	77	23590	74	24450	78	25513	57	28690	77	30520	54
16551	157	20500	71	22572	76	23591	75	24470	78	25514	57	28710	77	30531	54
16552	157	20550	71	23311	72	23592	75	24500	78	25515	57	28720	77	30532	54
16553	157	20600	71	23312	72	23593	75	24510	78	25516	57	28725	77	30533	54
16554	157	20650	71	23313	72	23601	75	24520	78	25517	57	28733	77	30534	54

No.	Page	No.	Page	No.	Page	No.	Page	No.	Page	No.	Page	No.	Page	No.	Page
30535	54	33087	59: 322	35670	328	35831	335	37109	64	41381	40	48330	84	51580	8
30536	54	33105	59: 322	35671	328	35832	334	37110	64	41500	39	48530	84	51590	8
31010	54	33107	59: 322	35700	332	35839	330	37111	64	41510	43; 106	49200	84	51620	8
31030	54	33125	59: 322	35710	333	35840	330	37112	64	42300	40	49450	85	51630	8
31050	54	33127	59: 322	35750	332	35842	331	37113	64	42301	40	49460	85	51640	8
31070	54	33147	59: 322	35751	332	35843	330	37114	64	42302	41	49600	85	51645	8
31100	54	33177	59: 322	35755	332	35846	330	37115	64	42303	40	49610	85	51650	8
31150	54	33535	56	35756	332	35850	330	37150	64	42304	41	49750	85	51671	8
31200	54	33550	56	35757	332	35860	330	37200	64	42305	40	49760	85	51672	8
31300	54	33555	56	35758	332	35861	330	37250	64	42306	41	49770	85	51673	8
31400	54	33557	56	35759	332	35863	330	37300	64	42307	41	49771	85	51674	8
31500	54	33650	56	35760	334	35864	331	37380	64	42308	41	49772	85	51675	8
31600	54	33655	56	35761	333	35865	331	37400	64	42309	41	49773	85	51676	8
31800	54	33657	56	35762	333	35866	331	37430	64	43010	41	49774	85	51677	8
32000	54	33900	56	35763	331	35867	252	37500	64	43011	41	49775	85	51678	8
32110	55	33905	56	35764	333	35868	252	37800	64	43020	41	49800	146	51679	8
32201	55	33907	56	35765	323	35869	252	37900	64	43021	41	49801	146	51680	8
32202	55	33925	56	35767	325	35870	252	38150	64	43030	42	49802	146	51681	8
32203	55	33927	56	35768	325	35872	252	38200	64	43031	42	49805	145	51682	8
32204	55	33950	56	35770	333	35874	252	38401	64	43040	42	49806	145	51683	8
32205	55	34000	57	35773	333	35875	252	38402	64	43041	42	50070	10	51684	8
32206	55	34204	59	35774	333	35876	252	38403	64	43050	42	50090	10	51685	9
32207	55	34205	59	35775	334	35877	252	38404	64	43051	42	50100	10	51686	9
32208	55	34206	59	35776	333	35878	253; 342	38406	64	43052	42	50110	10	51687	9
32625	55	34207	59	35777	333	35880	253; 342	38407	64	43053	42	50120	10	51688	9
32627	56	34208	59	35779	332	35881	253; 342	38408	64	43055	42	50130	10	51689	9
32685	55	34210	59	35780	332	35889	253; 342	38409	64	43056	42	50150	10	51690	9
32687	56	34212	59	35781	332	35893	252; 344	38500	64	43057	42	50170	10	51691	9
32705	56	34220	59	35782	332	35894	252; 344	38515	64	43058	42	50190	10	51692	9
32715	56	34222	59	35783	332	35895	252; 344	38525	64	43060	42	50220	10	51693	9
32720	55	34225	59	35784	332	35899	253; 344	38750	64	43061	42	50270	10	51694	9
32900	61	34243	58	35785	313	35911	252; 343	38751	65	43062	42	50330	10	51695	9
32901	60	34245	58	35786	312	35912	252; 344	38830	65	43063	42	50560	10	51696	9
32902	60	34247	58	35787	312	35914	252	40010	38	43140	42	50580	10	51705	9
32904	60	34251	58	35788	332	35915	252	40011	38	43500	42	50590	10	51710	9
32922	61; 323	34254	58	35789	332	35916	252	40012	38	43510	43	50610	10	51715	9
32923	61; 323	34256	58	35790	312	35918	252	40013	38	44100	43	50620	10	51720	9
32924	60; 323	34300	58	35791	312	35923	252	40014	38	44102	43	50630	10	51721	9
32925	60; 323	34600	58	35792	333	35924	252	40015	38	44300	43; 225	50850	8	51722	9
32926	60; 323	34750	58	35793	332	36000	65	40016	38	44301	43; 225	50861	8	51740	11
32930	59: 322	34900	58	35794	332	36004	65	40017	38	44400	43; 225	50871	8	51741	11
33000	60: 322	34944	136	35795	334	36005	65	40018	38	44500	43; 225	50880	8	52090	11
33001	60: 322	34945	136	35799	313	36006	65	40041	38	45000	48	51060	8	52100	11
33002	60: 322	34946	136	35800	328	36008	65	40042	38	45010	49	51070	8	52110	11
33003	60: 322	34947	136	35801	329	36014	65	40043	38	45012	49	51080	8	52120	11
33004	60: 322	34949	314	35802	328	36015	65	40044	38	45020	49	51090	8	52130	11
33005	60: 322	34950	145	35803	329	36016	65	40045	38	45050	48	51100	8	52170	11
33006	60: 322	35250	57	35805	329	36018	65	40047	38	45100	48	51110	8	52190	11
33007	60: 322	35300	57	35806	329	36032	66	40048	38	45103	48	51120	8	52220	11
33008	60: 322	35351	57	35807	329	36033	66	40050	38	45150	48	51130	8	52270	11
33022	60: 323	35352	57	35808	329	36034	66	40051	38	45151	48	51140	8	52340	11
33024	59: 322	35353	57	35809	329	36037	66	40054	39	45201	49	51150	8	52560	11
33026	59: 322	35355	57	35810	329	36038	66	40055	39	45500	48	51160	8	52570	11
33028	59: 322	35359	58	35812	331	36039	66	40056	39	45503	48	51170	8	52580	11
33030	59: 322	35360	58	35813	331	36570	66; 106	40057	39	48000	83	51180	8	52630	11
33032	59: 322	35362	58	35815	331	36650	65	40160	40	48050	83	51190	8	52652	9
33035	59: 322	35364	58	35816	331	37100	64	40180	40	48060	83	51200	8	52653	9
33038	59: 322	35366	58	35817	331	37101	64	40200	40	48070	83	51210	8	52654	9
33039	59: 322	35368	58	35821	334	37102	64	40700	40	48080	83	51220	8	52655	9
33040	59: 322	35372	58	35823	334	37103	64	41121	39	48081	84	51240	8	52656	9
33065	59: 322	35373	58	35824	334	37104	64	41151	39	48082	84	51270	8	52657	9
33067	59: 322	35374	58	35826	334	37106	64	41152	39	48100	84	51300	8	52658	9
33080	59: 322	35376	58	35828	334	37107	64	41180	39	48150	84	51320	8	52659	9
33085	59: 322	35430	58	35830	334	37108	64	41200	39	48200	84	51560	8	52660	9

No.	Page	No.	Page	No.	Page	No.	Page	No.	Page	No.	Page	No.	Page	No.	Page
52661	10	53460	16	55212	44; 107	56790	12	60932	22	61375	24	65650	30	69613	154
52680	11	53470	16	55215	44; 107	57000	176	60933	22	61376	24	65700	30	69620	153
52700	11	53480	16	55216	44; 107	57010	176	60934	22	61377	24	65800	30	69621	153
52710	11	53490	16	55217	44; 107	57020	176	60935	22	61378	24	65850	32	69630	154
52720	11	53500	17	55220	44; 107	57030	177	60936	22	61379	24	66080	31	69631	154
52730	11	53520	17	55221	44; 107	57050	177	60937	22	61380	24	66112	31	69635	154
52740	11	53540	17	55222	44; 107	57091	179; 197	60938	22	61381	24	66113	32	69637	154
52750	11	53560	17	55250	44; 106	57100	177	60939	22	61382	24	66200	32	69850	314
52770	11	53561	17	55300	44; 106	57160	177	60950	22	61383	24	66210	31	69851	314
52790	11	53562	17	55350	44; 106	57210	177	60951	22	61384	24	66330	30	70000	114
52820	11	53563	17	55450	44; 106	57260	177	60952	22	61385	24	66400	30	70020	114
52830	10	53571	17	55500	109; 257; 362	57300	13	60953	22	61386	24	66410	30	70023	114
52831	10	53572	17	55505	110; 257; 362	57350	13	60954	22	61392	24	66570	30	70030	114
52840	11	53573	17	55530	110; 257; 363	57400	13	60955	22	61393	24	66580	31	70050	114
52841	11	53580	17	55531	110; 257; 363	57450	13	60956	22	61394	24	66710	31	70100	114
52842	11	53598	16	55541	110; 257; 363	57600	174	60957	22	61395	24	66720	31	70150	114
52843	11	53599	16	55542	110; 257; 363	57610	175	60958	22	61550	24	66760	31	70160	114
52844	11	53600	16	55544	110; 257; 363	57612	175	60959	22	61560	24	66770	31	70200	115
52845	11	53610	16	55545	110; 257; 363	57613	175	60961	22	61580	24	69490	153	70210	115
52846	11	53630	16	55620	44; 107	57614	175	60962	22	61590	25	69491	153	70320	115
52847	11	53650	16	55625	44; 107	57620	175	60963	22	61600	25	69492	153	70330	115
52850	12	53670	16	55630	44; 107	57630	175	60964	22	61640	25	69493	153	70340	115
52851	12	53700	16	55635	44; 107	57640	175	60965	22	62158	28	69494	153	70400	115
52852	12	53710	16	55645	44; 107	57650	175	60966	22	64050	28	69502	153	70410	115
52853	12	53730	17	55660	44; 107	57700	177	60967	22	64060	28	69503	153	70420	115
52854	12	53760	16	55690	44; 107	58140	18	60968	22	64070	28	69504	153	70430	115
52855	12	54000	12	55792	45; 107	58150	19	60969	22	64090	28	69505	153	70480	115
52860	12	54032	13	55800	106	58160	17	60970	23	64310	29	69506	153	70490	115
52871	10	54033	13	55820	106	58210	17	60975	23	64330	29	69507	153	70500	115
52872	10	54034	13	55830	106	58240	18	60976	23	64370	29	69508	153	70510	115
52873	10	54041	13	56040	32	58260	18	61010	23	64371	29	69509	153	71000	115
52874	10	54042	13	56050	32	58520	18	61020	23	64380	29	69510	153	71040	115
52875	10	54043	13	56060	32	58530	18	61030	23	64395	29	69521	153	71042	116
52876	10	54044	13	56070	32	58540	172	61040	23	64396	29	69522	154	71050	115
52877	10	54055	13	56080	32	58600	18	61050	23	64553	29	69539	154	71150	116
52880	10	54056	13	56100	32	58602	18	61060	23	64554	29	69540	154	71800	357
52900	12	54057	13	56120	32	58682	19	61070	23	64650	28	69542	154	71801	357
52932	13	54058	13	56130	32	60880	22	61080	23	64651	26	69543	154	71802	357
52933	13	54499	44; 107	56140	32	60881	22	61090	23	64654	25	69546	154	71803	357
52935	13	54500	44; 107	56170	32	60882	22	61100	23	64655	27	69550	154	71804	357
52936	13	54510	44; 107	56380	32	60883	22	61110	23	64657	27	69551	154	71805	357
53080	16	54600	12	56390	32	60884	22	61120	23	64658	26	69552	154	71807	357
53100	16	54610	12	56391	32	60885	22	61130	23	64660	27	69574	153	71808	357
53110	16	54620	12	56392	32	60886	22	61140	23	64940	25	69575	153	71809	357
53120	16	54630	12	56393	32	60887	22	61150	23	64950	25	69579	153	71810	357
53130	16	54640	12	56400	33	60888	22	61160	23	64951	26	69580	153	71811	357
53140	16	54650	12	56470	33	60889	22	61170	23	65040	26	69583	153	71812	357
53150	16	54660	12	56473	33	60890	22	61210	24	65041	26	69587	153	71814	357
53160	16	54670	12	56475	33	60891	22	61220	24	65045	27	69590	154	71815	357
53170	16	54680	12	56477	33	60910	25	61230	24	65080	26	69591	154	71816	357
53180	16	54690	12	56478	34	60912	22	61240	24	65100	28	69592	154	71817	357
53190	16	54700	12	56501	33	60913	22	61250	24	65120	27	69594	154	71818	357
53210	16	54710	12	56505	33	60914	22	61260	24	65122	27	69595	154	71819	357
53220	16	54720	12	56506	33	60915	22	61270	24	65150	28	69596	154	71820	358
53240	16	54730	12	56507	34	60916	22	61280	24	65170	26	69597	154	71821	358
53270	16	54750	12	56550	34	60917	22	61290	23	65233	49	69598	154	71822	358
53300	16	54760	12	56600	34	60918	22	61300	24	65235	49	69599	154	71823	358
53320	16	54780	12	56710	12	60920	22	61310	24	65260	177	69600	154	71824	358
53400	16	54860	12	56720	12	60921	22	61320	24	65270	178	69601	154	71825	358
53410	16	55100	44; 107	56730	12	60922	22	61330	24	65520	30	69602	154	71827	358
53420	16	55150	44; 107	56740	12	60923	22	61340	24	65610	30	69608	154	71828	358
53430	16	55200	44; 107	56750	12	60924	22	61350	24	65620	30	69609	154	71829	358
53440	16	55210	44; 107	56770	12	60930	25	61360	24	65630	30	69610	154	71830	358
53450	16	55211	44; 107	56780	12	60931	22	61370	24	65640	30	69612	154	71831	358

No.	Page	No.	Page	No.	Page	No.	Page	No.	Page	No.	Page	No.	Page	No.	Page
71832	358	72533	288	72861	283; 341	73060	205	73590	118	74102	272	74435	224; 279	74667	284
71833	358	72534	288	72862	283; 341	73200	222	73598	118	74103	272	74436	224; 279	74680	268
71834	358	72535	288	72863	283; 341	73201	222	73612	118	74104	272	74439	225; 281	74681	268
71835	358	72570	289	72864	283; 341	73260	119	73614	118	74105	272	74440	223; 278	74685	268
71836	358	72572	289	72900	285; 341	73271	119	73616	118	74106	272	74441	223; 278	74688	268
71837	358	72573	289	72901	285; 341	73300	119	73620	118	74107	272	74442	223; 278	74689	268
71838	358	72600	289	72902	285; 341	73325	129	73621	118	74108	272	74443	223; 278	74693	268
71840	358	72615	288	72903	285; 341	73330	129	73625	118	74110	273; 337	74447	223; 278	74695	269
71841	358	72616	288	72905	285	73331	129	73627	118	74111	273; 337	74448	223; 278	74701	268
71842	358	72617	288	72906	285	73332	130	73632	118	74113	274; 338	74449	225; 279	74702	268
71843	358	72620	288	72907	285	73340	130	73640	118	74115	274; 338	74450	223; 278	74705	267
71844	358	72621	288	72908	285	73341	130	73645	118	74117	273; 337	74451	225; 280	74730	264
71846	358	72622	288	72909	285	73342	130	73660	118	74121	273; 338	74452	225; 280	74731	264
71847	358	72625	288	72920	256	73343	130	73670	118	74123	273; 338	74453	225; 280	74732	264
71848	358	72626	288	72921	256	73344	130	73680	118	74125	273; 337	74454	225; 280	74733	264
71849	358	72627	288	72922	256	73350	131	73695	118	74126	273; 337	74455	225; 280	74734	264
71850	358	72630	288	72930	256	73351	131	73700	118	74127	273; 337	74456	225; 280	74740	265
71851	358	72631	288	72931	256	73352	131	73710	118	74128	273; 337	74457	224; 278	74741	265
71852	358	72632	288	72932	256	73353	131	73720	118	74130	273; 337	74459	276	74742	265
71853	358	72683	284	72933	250	73360	131	73730	118	74131	273; 337	74460	276	74743	265
71854	358	72684	284	72934	250	73362	131	73740	118	74132	273; 337	74461	280; 339	74744	265
71855	358	72685	284	72935	250	73400	108; 129	73775	118	74133	273; 337	74462	280; 339	74750	265
71856	359	72686	284	72936	250	73403	108; 129	73820	118	74134	273; 337	74463	280	74751	265
71857	359	72750	289	72937	250	73410	108; 129	73831	118	74135	273; 337	74464	280	74752	265
71858	359	72755	289	72938	250	73500	216	73833	118	74136	273; 337	74466	280	74753	266
71859	359	72801	284	72939	250	73506	118; 298	73835	118	74137	273; 337	74467	280	74754	266
71860	359	72802	284	72942	250	73507	118; 298	73836	118	74140	275	74480	224; 279	74760	266
72040	116	72803	284	72943	250	73508	118; 298	73838	118	74142	275	74481	224; 279	74761	266
72060	116	72804	284	72944	250	73510	118; 298	73881	119	74145	275	74482	224; 279	74762	266
72080	116	72805	284	72945	250	73511	118; 298	73882	119	74146	274	74501	276; 338	74765	266
72100	116	72806	284	72948	250	73515	117	73883	119	74148	275	74502	276; 338	74766	266
72120	116	72807	284	72950	250	73516	117	73884	119	74150	274	74503	276; 339	74771	266
72140	116	72808	284	72951	250	73517	117	73885	119	74151	274	74504	276; 339	74772	267
72400	290	72809	284	72952	250	73521	117	73886	119	74152	275	74508	276; 339	74773	267
72401	290	72821	284	72956	250	73522	117	73887	119	74153	275	74509	277; 339	74775	267
72402	290	72822	284	72958	250	73523	117	73888	119	74154	275	74540	277	74776	267
72404	290	72823	284	72960	250	73525	117	73891	119	74160	274	74541	277	74777	267
72407	290	72824	284	72963	250	73527	117	73892	119	74162	274	74542	277	74802	260
72451	289	72825	284	72964	250	73528	117	73893	119	74164	274	74543	277	74804	260
72452	289	72826	284	72965	250	73529	117	73894	119	74190	282; 338	74580	282; 339	74812	260
72455	289	72827	284	72966	250	73530	117	73895	119	74191	282; 338	74581	282; 339	74816	261
72484	288	72828	284	72967	250	73532	117	73896	119	74192	282; 338	74585	282	74818	261
72486	288	72829	284	72968	250	73533	117	73897	119	74193	282; 338	74600	281; 340	74820	261
72489	288	72831	283; 341	72969	250	73534	117	73898	119	74194	282; 338	74601	281; 340	74828	261
72490	288	72832	283; 341	72970	250	73535	117	73906	119	74195	282; 338	74602	281; 340	74831	261
72493	288	72833	283; 341	72974	251	73536	117	73909	119	74201	282; 340	74610	281; 340	74833	261
72494	288	72834	283; 341	72975	251	73539	117	73929	118	74220	285	74620	281; 340	74835	261
72500	288	72835	283; 341	72976	251	73540	117	74000	272	74221	285	74622	281; 340	74836	261
72501	288	72836	283; 341	72977	251	73544	117	74004	272	74222	285	74623	282; 341	74838	261
72504	288	72840	283; 341	72978	251	73545	117	74077	275	74223	285	74624	281; 340	74841	261
72505	288	72841	283; 341	72979	251	73546	117	74078	275	74224	285	74635	285	74843	261
72506	288	72842	283; 341	72981	251	73561	117	74079	275	74255	222	74636	285	74846	261
72508	288	72843	283; 341	72984	251	73562	117	74080	275	74307	222	74637	285	74849	261
72509	288	72844	283; 341	72985	251	73563	117	74081	276	74311	222	74638	285	74851	262
72510	288	72845	283; 341	72988	249	73565	117	74082	276	74316	222	74639	285	74853	262
72524	288	72846	283; 341	72989	249	73567	117	74084	275	74400	222; 277	74640	283	74855	262
72525	288	72850	283; 341	72990	249	73568	117	74085	275	74410	222; 277	74644	283	74856	262
72526	288	72851	283; 341	73040	205	73569	117	74086	275	74411	223; 277	74660	284	74858	261
72527	288	72852	283; 341	73051	205	73570	117	74087	274	74420	222	74661	284	74861	262
72528	288	72853	283; 341	73052	205	73571	117	74088	274	74421	222	74662	284	74863	262
72529	288	72854	283; 341	73056	205	73572	117	74089	274	74422	222	74663	284	74866	262
72530	288	72858	283; 341	73057	206	73573	117	74094	272	74430	222	74664	284	74869	262
72531	288	72859	283; 341	73058	206	73574	117	74100	272; 337	74431	222	74665	284	74881	262
72532	288	72860	283; 341	73059	206	73575	117	74101	272; 337	74432	222	74666	284	74882	262

No.	Page	No.	Page	No.	Page	No.	Page	No.	Page	No.	Page	No.	Page	No.	Page
74883	262	75141	121; 143	75545	353	76015	95	76902	235	77194	232	78042	173	78585	249
74885	262	75200	109	75548	354	76160	95	76903	235	77195	232	78043	173	78586	249
74886	262	75201	109	75549	353	76180	95	76904	235	77196	232	78044	174	78587	249
74887	262	75202	109	75550	354	76181	95	76905	235	77197	232	78045	173	78590	249
74891	262	75230	121	75551	354	76182	95	76906	235	77198	232	78046	172	78591	249
74892	262	75231	120	75552	354	76183	95	76910	236	77200	231	78047	173	78592	249
74893	262	75233	121	75553	356	76184	95	76911	236	77203	231	78050	173	78611	228
74894	262	75238	120; 143	75554	356	76185	96	76912	236	77204	231	78061	173	78612	228
74895	262	75239	120; 143	75555	359	76190	96	76913	236	77205	231	78067	173	78613	228
74896	262	75240	120; 143	75556	359	76210	96	76914	236	77210	230	78068	173	78614	229
74897	262	75245	120; 143	75557	359	76214	96	76915	236	77211	230	78300	174	78615	229
74898	262	75246	120; 143	75558	359	76220	96	76920	236	77212	230	78303	174	78616	229
74901	263	75247	120; 143	75559	359	76230	96	76921	236	77213	230	78306	174	78620	228
74902	263	75260	120; 143	75562	354	76250	96	76922	236	77230	230	78320	108	78621	228
74903	263	75261	120; 143	75564	356	76280	96	76923	236	77231	230	78341	108	78622	228
74904	263	75262	120; 143	75565	356	76305	97	76924	236	77232	230	78381	108	78623	228
74910	263	75270	120; 142	75570	356	76311	97	76930	236	77235	230	78383	108	78624	228
74911	263	75271	120; 142	75571	356	76312	97	76931	236	77240	230	78385	108	78626	229
74912	263	75272	120; 142	75572	356	76314	97	76932	236	77241	230	78400	178	78627	229
74913	263	75273	120; 142	75573	356	76526	94	76933	236	77249	230	78401	178	78628	229
74914	263	75274	120; 142	75574	356	76621	94	76934	236	77250	230	78402	178	78630	229
74920	263	75285	120; 142	75578	357	76622	94	76935	236	77300	230	78432	228	78632	229
74921	263	75286	120; 142	75579	357	76640	94	76940	236	77350	230	78434	228	78633	229
74922	263	75287	120; 142	75594	357	76650	94	76941	236	77400	230	78436	228	78641	228
74923	263	75288	120; 142	75595	357	76660	94	76942	236	77500	230	78450	267	78642	228
74924	263	75295	119	75596	356	76700	97	76943	236	77600	230	78451	267	78700	242
74926	263	75300	120; 143	75597	356	76705	97	76944	236	77603	230	78460	237	78710	242
74927	263	75301	119; 143	75598	357	76750	260	76945	236	77607	231	78463	237	78720	242
74928	263	75302	119; 143	75599	357	76751	260	76950	236	77700	231	78480	232	78730	242
74930	263	75303	119; 143	75620	355	76752	260	76951	236	77815	238	78481	232	78750	242
74931	263	75304	119; 143	75621	355	76755	260	77004	229	77830	238	78482	232	78755	178
74932	263	75327	351	75622	355	76756	260	77005	229	77831	238	78490	233	78785	243
74933	263	75328	351	75623	355	76757	260	77006	229	77833	238	78491	233	78790	243
74935	263	75329	351	75624	355	76760	260	77010	229	77834	238	78493	233	78791	243
74936	263	75330	351	75625	355	76761	260	77020	229	77835	238	78494	233	78793	243
74937	263	75331	351	75626	355	76762	260	77030	229	77837	238	78500	234	78794	243
74940	263	75332	352	75627	354	76765	260	77040	229	77838	238	78501	234	78800	242
74941	263	75333	352	75629	354	76766	260	77050	229	77840	238	78510	234	78801	242
74944	263	75470	362	75631	355	76767	260	77051	229	77845	238	78511	234	78802	242
74945	263	75482	362	75660	359	76800	217	77052	229	77850	238	78513	235	78803	242
74960	264	75483	352	75661	360	76801	217	77053	229	77851	239	78520	235	78809	242
74970	269	75484	352	75855	360	76806	217	77054	229	77852	239	78525	235	78810	242
74973	269	75485	352	75910	360	76807	217	77055	229	77860	239	78526	235	78811	243
74974	269	75486	352	75911	360	76810	217	77061	229	77861	239	78550	248	78812	243
74975	269	75487	353	75912	360	76811	217	77062	229	77870	239	78551	248	78813	243
74977	269	75488	353	75913	360	76812	217	77063	229	77871	239	78552	248	78815	243
74980	269	75498	352	75914	360	76814	217	77064	229	77872	239	78553	248	78816	243
74983	269	75499	352	75915	264; 362	76815	217	77110	230	77881	239	78555	248	78818	243
74985	269	75500	350	75916	264; 362	76816	217	77120	230	77900	237	78556	248	78819	243
75000	121	75501	350	75920	362	76818	217	77130	230	77910	237	78557	248	78822	244
75012	121	75502	350	75970	360	76819	217	77140	230	77911	237	78560	248	78824	244
75028	121	75503	351	75971	361	76820	217	77150	230	77912	237	78561	248	78825	244
75030	121; 144	75504	351	75972	361	76822	217	77170	231	77920	237	78562	248	78826	244
75031	121; 144	75506	351	75973	361	76823	217	77171	231	77921	237	78566	248	78852	209
75035	121	75510	350	75974	361	76824	217	77180	231	77930	237	78568	248	78910	210
75036	121	75511	350	75975	361	76826	217	77184	232	78000	173	78570	248	78911	210
75050	121	75512	350	75976	361	76827	217	77185	232	78020	256	78571	248	78912	210
75060	121	75514	350	75990	361	76828	217	77186	232	78021	256	78572	248	78945	201
75100	120; 143	75516	350	75991	361	76830	217	77187	232	78022	257	78575	248	78947	201
75101	120	75540	353	75992	361	76832	218	77188	232	78030	174	78576	248	78948	201
75102	120	75541	353	75993	361	76835	217	77190	231	78031	174	78577	248	78950	201
75103	120	75542	353	76000	94	76836	218	77191	231	78035	174	78580	249	78970	194
75104	120	75543	353	76010	94	76900	235	77192	231	78040	172	78581	249	78971	195
75140	121; 143	75544	354	76011	95	76901	235	77193	231	78041	172	78582	249	78973	195

No.	Page	No.	Page	No.	Page	No.	Page	No.	Page	No.	Page	No.	Page	No.	Page
78975	196	79324	204	79640	215	79982	218	81115	161	82005	183	82677	289	83822	290
78976	196	79325	204	79641	215	79983	218	81117	161	82020	183	82682	289	83823	290
78977	196	79327	204	79667	311	79984	218	81141	161	82021	184	82684	289	83831	290
78978	196	79328	204	79668	311	79990	218	81142	161	82200	184	82685	289	83832	291
78979	196	79329	205	79672	311	79991	218	81370	168	82201	184	82687	289	85020	189; 255
78980	196	79332	201	79722	316	79992	218	81371	168	82205	184	82701	179; 292	85030	189; 255
79002	192	79334	203	79723	316	79993	219	81372	168	82206	184	82703	179; 292	85040	189; 255
79004	192	79346	216	79724	316	79994	219	81373	168	82207	184	82705	179; 292	85050	189; 255
79005	192	79350	208	79748	310	79996	219	81374	168	82210	184	82712	179; 293	85060	189; 255
79007	192	79351	208	79755	310	79997	219	81378	168	82225	184	82713	179; 293	85080	189; 255
79012	192	79353	209	79760	206	79998	219	81379	168	82231	184	82714	179; 293	85090	189; 255
79013	193	79354	209	79761	206	80001	219	81380	168	82232	184	82715	180; 293	85100	189; 255
79015	193	79355	209	79764	206	80002	219	81387	168	82233	184	82716	180; 293	85112	189; 255
79018	193	79358	208	79800	215	80010	180	81390	168	82234	184	82717	180; 293	85113	189; 255
79022	193	79365	207	79835	321	80011	180	81391	168	82300	187	82718	292	85114	189; 255
79023	193	79366	207	79861	321	80020	180	81399	168	82301	187	82720	180; 293	85115	189; 255
79024	192	79367	207	79862	321	80030	180	81400	168	82304	188	82721	180; 293	85116	189; 255
79026	193	79368	207	79863	321	80040	180	81401	168	82305	187	82722	180; 294	85118	189; 255
79030	194	79373	207	79865	321	80050	180	81490	167	82308	187	82725	180; 294	85119	189; 255
79036	194	79374	207	79866	321	80060	180	81491	167	82310	187	82771	292	85120	189; 255
79046	194	79376	207	79867	321	80070	180	81492	167	82315	187	82772	292	85122	189; 255
79047	194	79377	208	79869	310	80080	180	81500	167	82320	187	82786	291	85123	189; 255
79053	194	79378	208	79880	212; 304	80110	181	81501	167	82331	188	82787	292	85124	189; 255
79056	195	79379	208	79883	212; 305	80120	181	81502	167	82341	188	82788	291	85125	189; 255
79060	196	79380	208	79890	212; 304	80121	181	81519	168	82343	189	82789	291	85126	189; 255
79075	195	79381	208	79891	212; 304	80232	181	81520	168	82351	188	82790	291	85128	189; 255
79077	195	79382	207	79892	212; 304	80252	181	81521	168	82355	65	82791	291	85129	189; 255
79079	195	79383	207	79893	212; 304	80271	181	81522	168	82360	187	82792	291	85130	189; 255
79084	196	79385	207	79894	212; 304	80300	181	81523	168	82370	187	82793	291	86700	257
79085	196	79386	217	79896	212; 304	80302	181	81524	168	82372	188	82795	291	86701	257
79086	196	79387	217	79897	212; 304	80303	181	81525	168	82373	188	82796	291	86750	109
79087	196	79389	217	79898	212; 304	80306	181	81527	168	82374	188	82797	291	86751	109
79088	196	79390	218	79899	212; 304	80312	182	81553	167	82375	188	82798	291	86752	109
79089	196	79391	218	79903	211	80320	182	81556	167	82377	188	82800	293	86760	109
79098	197	79395	218	79904	211	80330	182	81560	167	82378	188	82801	293	86761	109
79100	197	79398	217	79905	211	80340	182	81562	167	82379	188	82910	185	86770	109
79104	197	79410	203	79906	211	80350	182	81617	162	82380	188	82920	185	86771	109
79105	197	79413	203	79907	212	80402	182	81618	162	82384	188	82939	185	86780	285
79108	198	79442	214; 315	79909	211	80410	182	81637	162	82386	188	82941	216	86785	285
79113	198	79444	214; 315	79912	212; 305	80412	182	81638	162	82388	188	82942	201	87301	258
79114	198	79448	214; 315	79913	212; 305	80450	182	81640	163	82390	188	83000	185	87302	258
79116	198	79456	213; 311	79914	212; 305	80500	175	81644	163	82392	189	83001	185	87303	258
79117	198	79467	214; 311	79919	214	80510	175	81647	163	82393	189	83002	186	87305	258
79120	198	79468	311	79926	213; 305	80520	175	81650	161	82395	189	83005	186	87307	258
79129	199	79475	203	79927	213; 305	80530	175	81653	161	82397	189	83260	186	87311	258
79140	199	79477	202	79928	213; 305	80534	175	81661	161	82400	188	83261	186	87312	258
79141	199	79478	202	79929	213; 305	80600	176	81761	156	82431	185	83262	186	87313	258
79148	199	79479	202	79930	213; 305	80601	176	81762	156	82440	184	83266	186	87315	258
79202	209	79481	202	79931	213; 305	80620	176	81771	156	82445	184	83267	186	87317	258
79203	210	79482	202	79932	213; 305	80640	176	81780	49	82501	185	83270	186	87321	258
79204	210	79484	202	79933	213; 305	80660	177	81781	156	82502	185	83280	187	87322	258
79237	200	79491	200	79942	211	80661	177	81782	156	82504	185	83463	187	87323	258
79238	200	79493	200	79960	306	80700	176	81783	49	82506	185	83465	187	87325	258
79252	203	79500	196; 312; 314	79962	306	80751	183	81784	50	82520	185	83710	187; 282	87327	258
79253	203	79501	197; 312; 315	79963	306	80752	183	81785	156	82550	182	83801	290	87331	258
79255	199	79550	310	79965	306	80753	183	81820	179	82551	182	83802	290	87332	258
79256	214	79551	310	79968	306	80901	162	81823	178	82552	183	83803	290	87333	258
79261	209	79552	310	79969	306	80902	162	81824	178	82553	183	83804	290	87335	258
79285	210	79570	215	79971	306	81100	160	81825	178	82610	183	83805	290	87337	258
79309	200	79572	215	79973	306	81101	160	81830	172	82611	183	83806	290	87351	258
79314	199	79580	215	79975	306	81108	160	81840	244	82650	183	83811	290	87352	258
79316	200	79600	215	79977	218	81109	160	81843	244	82671	289; 346	83812	290	87353	258
79318	204	79620	215	79978	218	81110	160	81844	244	82673	289; 346	83813	290	87354	258
79320	204	79630	215	79979	218	81114	160	82000	183	82675	289; 346	83821	290	87361	258

No.	Page	No.	Page	No.	Page	No.	Page	No.	Page	No.	Page	No.	Page	No.	Page
87362	258	88672	294	89218	301: 303	89307	298	89457	345	89553	304	99209	317	GV-0400	163
87363	258	88673	294	89219	301: 303	89308	298	89458	345	89560	144	99210	318	GV-0420	163
87364	258	88674	294	89220	300	89310	298	89459	345	89561	144	99230	317	GV-0510	164
87371	258	88700	313	89221	306	89311	298	89462	345	89562	144	99240	318	GV-0610	164
87372	258	88701	313	89222	306	89312	298	89463	345	89563	144	99300	312	GV-0620	164
87373	258	88702	313	89223	306	89313	298	89464	345	89564	144	99301	312	GV-0631	164
87374	258	88703	313	89224	306	89314	298	89465	345	89600	321: 327	99310	319	GV-0656	164
87381	258	88704	313	89225	306	89315	298	89466	345	89601	321: 327	99315	319	GV-0658	164
87382	258	88705	313	89226	306	89316	298	89467	345	89880	345	99351	303	GV-0700	164
87383	258	88801	346	89227	306	89318	298	89470	345	99005	315	99390	313	GV-0710	164
87384	258	88805	346	89228	306	89319	298	89471	345	99006	315	99391	313	GV-0720	164
87391	259	88806	346	89229	306	89320	298	89472	345	99007	316	99400	313	GV-0730	165
87392	259	88809	346	89230	306	89330	298	89473	345	99008	316	99401	313	GV-0740	165
87393	259	88811	346	89231	306	89331	298	89474	345	99011	324	99402	335	GV-0861	165
87401	259	89000	346	89232	306	89335	298	89475	345	99012	323	99403	335	GV-0871	165
87402	259	89100	307	89233	308	89336	298	89478	345	99013	325	99404	335	GV-0925	165
87403	259	89101	307	89234	308	89342	299	89479	345	99020	323	99405	335	GV-1100	165
87411	259	89102	307	89235	306	89345	299	89480	345	99021	325	99406	335	GV-1101	165
87412	259	89103	307	89236	306	89347	299	89481	345	99023	325	99407	335	GV-1102	165
87413	259	89104	307	89239	307	89348	299	89482	345	99024	324	99408	335	GV-1105	165
87421	259	89105	307	89240	307	89351	298	89483	345	99025	324	99409	335	GV-1121	165
87422	259	89106	308	89241	307	89390	301: 304	89484	345	99026	326	99410	335	GV-1122	165
87423	259	89107	308	89242	307	89401	344	89485	345	99027	324	99411	335	GV-1123	165
87425	259	89108	308	89243	308	89402	344	89486	345	99028	326	99412	335	GV-1150	166
87427	259	89109	308	89244	308	89403	344	89490	346	99033	326	99415	336	GV-1151	166
87431	259	89110	308	89245	308	89404	344	89491	346	99041	326	99416	336	GV-1152	166
87432	259	89112	309	89246	308	89405	344	89492	346	99047	324	99418	336	GV-1160	166
87433	259	89113	308	89247	308	89406	344	89493	346	99048	323	99419	336	GV-1161	166
87435	259	89120	303	89248	308	89411	344	89507	320: 326	99049	325	99425	336	GV-1180	166
87437	259	89187	301	89251	307	89412	344	89508	320: 326	99050	325	99426	336	GV-1181	166
87441	259	89188	301	89252	307	89413	344	89509	320: 326	99051	324	99427	336	GV-1182	166
87442	259	89189	299	89253	306	89414	344	89515	320: 326	99052	325	99428	336	GV-1200	166
87443	259	89190	299	89260	302	89415	344	89518	320: 326	99053	324	99429	336	GV-1201	166
87445	259	89191	300	89261	302	89416	344	89520	320: 327	99054	324	99430	336	GV-1202	166
87447	259	89192	300	89262	302	89421	344	89525	321: 327	99055	326	99435	337	GV-1220	166
87451	259	89193	299	89263	302	89422	344	89526	321: 327	99103	318	99436	337	GV-1221	166
87452	259	89194	299	89265	303	89423	344	89528	321: 327	99109	318	99438	337	GV-1240	166
87453	259	89195	300	89266	302	89424	344	89536	342	99110	319	99440	337	GV-1241	166
87454	259	89201	301	89267	303	89425	344	89537	342	99111	318	99442	337	GV-1242	166
87455	259	89202	301	89268	302	89426	344	89538	342	99112	319	99443	337	GV-1272	166
87456	259	89203	309	89270	309	89441	344	89539	342	99115	318	99444	337	GV-1382	167
87457	259	89204	309	89280	303	89442	344	89540	343	99116	318	99445	337	GV-1384	167
87461	259	89206	309	89281	306	89443	344	89541	343	99190	317	99446	337	GV-1385	167
87462	259	89207	309	89298	298	89444	344	89542	343	99191	318	99530	346	GV-1386	167
87463	259	89208	309	89299	298	89445	344	89543	343	99202	317	99568	347	GV-1387	167
87465	259	89209	300	89300	298	89452	344	89545	343	99203	317	99575	347	GV-1388	167
87467	259	89210	300	89302	298	89453	344	89546	343	99204	317	GV-0062	163	GV-1582	166
88670	294	89213	300	89303	298	89454	344	89547	343	99207	317	GV-0082	163	GV-1583	166
88671	294	89215	300	89305	298	89456	345	89552	304	99208	317	GV-0083	163	UBIHA	90
														UFLEX	90



Memo

Memo

PL

I. TOYA S.A. informuje, iż:

- 1) niniejszy katalog nie stanowi oferty w rozumieniu prawa cywilnego;
- 2) prezentowane w niniejszym katalogu artykuły mogą w rzeczywistości odbiegać od wskazanego na zdjęciach wzoru, w szczególności jeżeli chodzi o cechy zewnętrzne, tj. wielkość, kolor, sposób opakowania, ilość przedmiotów w opakowaniu;
- 3) nie ponosi odpowiedzialności za drobne różnice w sposobie pakowania czy właściwościach artykułów pozostających bez wpływu na jego przeznaczony cel lub sposób użytkowania;
- 4) nie ponosi odpowiedzialności wynikającej z jakichkolwiek niedokładności lub nieścisłości, co do informacji zawartych w przedmiotowym katalogu;
- 5) nie ponosi odpowiedzialności za ewentualną szkodę powstałą w wyniku otrzymania towaru o innych właściwościach niż prezentowany na zdjęciach.

II. Pomimo najlepszych starań poczynionych przez TOYA S.A. nie może ona zagwarantować, iż informacje zawarte w niniejszym katalogu w pełni odpowiadają rzeczywistości.

III. Wszelkie decyzje podjęte na podstawie informacji zawartych w przedmiotowym katalogu podejmowane są na własne ryzyko osoby, która korzysta z tych informacji.

GB

I. TOYA S.A. informs that:

- 1) the present catalogue does not constitute an offer as construed in the civil law;
- 2) the goods presented in the present catalogue may in fact differ from the models shown in the pictures, particularly as far as external properties are concerned, namely size, colour, packaging, number of items in the package;
- 3) the company will not be held responsible for small differences in packaging or properties of the goods, which do not affect the purpose or the exploitation of the tools;
- 4) the company will not be held responsible for any inaccuracies or imprecision regarding the information presented in the catalogue;
- 5) the company will not be held responsible for any damage caused by goods whose properties differ from those of the tools presented in the photographs.

II. In spite of all the efforts made by TOYA S.A., the company cannot guarantee the information contained in the present catalogue fully correspond to the reality.

III. Any decisions made on the basis of the information contained in the present catalogue will be made at the risk of the person who makes them using the aforementioned information.

D

I. TOYA S.A. informiert, dass:

- 1) der vorliegende Katalog kein Angebot im zivilrechtlichen Sinne darstellt;
- 2) die im vorliegenden Katalog präsentierten Artikel in der Realität von den auf den Musterfotos gezeigten abweichen können, und zwar besonders dann, wenn es um äußere Eigenschaften geht, wie z.B. Größe, Farbe, Art der Verpackung, Anzahl der Gegenstände in der Verpackung;
- 3) sie keine Verantwortung für geringfügige Unterschiede bei der Verpackungsart oder den Eigenschaften der Artikel übernimmt, die ohne Auswirkungen auf seinen Bestimmungszweck oder die Art der Nutzung bleiben;
- 4) sie keine Verantwortung für irgendwelche Oberflächlichkeiten und Ungenauigkeiten bzgl. der im Sachkatalog enthaltene Informationen übernimmt;
- 5) sie keine Verantwortung für eventuelle Schäden, die im Ergebnis des Erhalts der Ware mit anderen als auf den Fotos dargestellten Eigenschaften entstanden sind, übernimmt.

II. Trotz großer Bemühungen seitens TOYA S.A. kann die Firma nicht garantieren, dass die im vorliegenden Katalog enthaltenen Informationen voll der Realität entsprechen.

III. Sämtliche Entscheidungen, die auf der Grundlage der im Sachkatalog enthaltenen Informationen getroffen wurden, gehen auf das Risiko der Person, die diese Informationen benutzt.

RUS

I. TOYA S.A. заявляет:

- 1) настоящий каталог не является торговым предложением с точки зрения гражданского законодательства;
- 2) изделия, представленные в настоящем каталоге, могут отличаться от образцов на снимках, особенно внешним видом, то есть размером, цветом, способом упаковки, количеством предметов в упаковке;
- 3) производитель не отвечает за мелкие отличия в способе упаковки или свойствах изделий, которые не влияют на предназначение или способ пользования изделиями;
- 4) производитель не отвечает за мелкие неточности в сведениях из предметного каталога;
- 5) производитель не отвечает за ущерб, нанесенный вследствие поставки товара, отличающегося параметрами от указанного на снимках.

II. Несмотря на все усилия в данном направлении, компания TOYA S.A. не гарантирует, что информация, метаящаяся в настоящем каталоге, полностью отвечает действительности.

III. Риск, связанный с любыми решениями, принятыми на основании информации из предметного каталога, берут на себя лица, пользующиеся указанной информацией.

UA

I. Інформація від виробника, TOYA S.A.:

- 1) цей каталог не є комерційною пропозицією з точки зору цивільного законодавства;
- 2) вироби, представлені у цьому каталозі, можуть відрізнятися від зображених на фотографіях, особливо зовнішнім виглядом, тобто розміром, кольором, способом упаковки, кількістю предметів в упаковці;
- 3) виробник не несе відповідальність за дрібні відмінності у способі упаковки чи властивостях виробів, які не мають впливу на їх призначення чи спосіб користування ними;
- 4) виробник не несе відповідальність за дрібні неточності у інформації, включеної у цей каталог;
- 5) виробник не несе відповідальність за можливі збитки, нанесені внаслідок отримання виробів, що своїми параметрами відрізняються від зображених на фотографіях.

II. Незважаючи на зусилля у даному напрямку, фірма TOYA S.A. не гарантує, що інформація, включена у цей каталог, повністю відповідає дійсності.

III. Приймаючи будь-які рішення на підставі інформації, включеної у цей каталог, не забувайте, що пов'язаний з ними ризик беруть на себе особи, що використовують включену у каталог інформацію.

LT

I. TOYA S.A. informuoja, kad:

- 1) šis katalogas nėra civilinės teisės supratimu pasiūlymas;
- 2) rodomos šame kataloge prekės JŲ DOMINŲP RŪMŲ VILŲVŲ OKRSDURG VR OKRMDNRRHSDM | GÄLR \ SDĖ JŲ LÄRUCH LÄYDŲ CD IUSRÄ P IDLV W G CÄIX VSDOD įpakavimo būdu, elementų kiekiu pakuojuote;
- 3) gamintojas nėra atsakomybės VÄ CHHŲIPŲ IOJXV VŲVMP XV įpakavimo arba gaminio savybėse, kurios neturi įtakos jo paskirčiai arba jo vartojimo būdai.
- 4) nėra taip pat atsakomybės dėl bet kokių netikslumų arba nepakankamai preciziškų apibrėžimų pateiktoje kataloge informacijoje.
- 5) nėra atsakomybės VÄ JŲ DŲP DLSDMŲV OKRWRDXV J DYXV SUHŲ su savybėmis, kurios nėra tapačios su pateiktomis nuotraukose.

.. 1 HÄŲrint geriausių TOYA S.A. pastangų, bendrovė negali garantuoti, kad pateikta šiame kataloge informacija pilnai atitinka tikrovę.

III. Bet kokie sprendimai priimami šiame kataloge pateiktą informaciją pagrindu yra besinaudojant šia informacija asmens priimami savo paties rizika.

LV

I. A/S „TOYA“ informē, ka:

- 1) šis katalogs nav piedāvājums civillikuma izpratnē;
- 2) piedāvāti šī katalogā produkti realitātē var atšķirties no rādīta uz fotogrāfijas parauga, sevišķi arēju īpašību sēfā, t.i. ar lielumu, krāsu, pakāšanas veidu, priekšmetu skaitu iepakojumā;
- 3) nav atbildīga par smalkām atšķirībām iepakojšanas veidā vai produktu īpašībās, ja tie neietekmē ierīces paredzētu mērķu vai lietošanas veidu;
- 4) nav atbildīga par kaut kādām neprecizitātēm informācijās, kas ir norādītas šī katalogā;
- 5) nav atbildīga par iespējamiem zaudējumiem, saienotiem ar produkta saņemšanu ar citām īpašībām, nekā rādītas uz fotogrāfijas.

II. Neskatoties uz visaugstāko rūpību, ar kuru A/S „TOYA“ sagatavoja savu katalogu, tā nevar garantēt, ka informācijas šī katalogā pilnīgi atbild realitātei.

III. Visi lēmumi, pieņemti pamatojoties uz informācijas no kataloga - ir pieņemti uz personas, kura lieto šo informāciju, risku.

CZ

, 72 < \$ 6 \$ ICRIP XIM ÄH

1) tento katalog nepředstavuje nabídku ve smyslu občanského práva;

2) výrobky prezentované v tomto katalogu se mohou ve skutečnosti lišit od modelů uvedených na obrázcích, zejména co se týká vnějších znaků, tj. velikosti, barvy, způsobu balení, počtu předmětů v balení;

3) nenese odpovědnost za drobné rozdíly ve způsobu balení nebo ve vlastnostech výrobků, které nemají zásadní vliv na jejich určený účel nebo způsobu SRXÄY Q

4) nenese odpovědnost vyplývající z jakýchkoli nepřesností co do informací uvedených v předmětném katalogu;

5) nenese odpovědnost za případné škody vzniklé v důvodě REGÄÄHQ | ERÄT VNOCP LYOMQRWV L CHÄ IM XYHGHC OD REU | RRFK

II. Navzdory mimořádným úsilím společnosti TOYA S.A. tato nemůže JDUQRYDM | CD informace uvedené v tomto katalogu zcela odpovídat skutečnosti.

III. Veškerá rozhodnutí přijatá na základě informací uvedených v předmětném katalogu jsou přímým | CD OD YOMÄQ UJ INR RVRE | NÄU WÄR ICRIP DFH Y XÄYD

SK

, 72 < \$ 6 \$ ICRIP XIM ÄH

1) tento katalóg nepredstavuje ponuku v zmysle občianskeho práva;

2) výrobky prezentované v tomto katalógu sa v skutočCRMP { ÄX CÄIF od modelov zobrazených na obrázkoch, najmä pokiaľ sa jedná o vonkajšie znaky, t.j. veľkosť, farbu, spôsob balenia, počet predmetov v balení;

3) nenesie zodpovednosť za drobné rozdiely v spôsobe balenia či vlastnostiach výrobkov, ktoré nemajú zásadný vplyv na ich určený účelHDBER VS | VRE SRXÄYDQD

4) nenesie zodpovednosť vyplývajúcu z akejkoľvek nepresnosti týkajúcej sa informácií uvedených v predmetnom katalógu;

5) nenesie zodpovednosť | D SUSDCQP ÄNRG Y | QNÖXY Y G VÖKVG REGÄÄQD WRYDX V ICP L vlastnosťDP L CHÄ IM XYHGHC OD REU | NRFK

II. Aj napriek mimoriadnemu úsiliu zo strany fIP | 72 < \$ 6 \$ WÄR CHP { ÄH JDUQRYDM |, či informácie uvedené v tomto katalógu plne zodpovedajú skutočnosti.

III. Všetky rozhodnutia prijaté na základe informácií uvedených v predmetnom katalógu sú prijíma- CP OD YOMÄQ UJ INR RVRE | NÄU WÄR ICRIP | FHY Y XÄYD

H

I. A TOYA S.A. tájékoztatja, hogy:

1) a jelen katalógus a polgári jog szerint nem kereskedelmi ajánlat;

2) a jelen katalógusban bemutatott árucikkek a valóságban eltérhetnek a képeken látható mintáktól, különösen a külső tulajdonságok, mint a méret, szín, csomagolási mód, a csomagban lévő tárgyak száma tekintetében;

3) nem vállal felelősséget a csomagolás módjában vagy az árucikkek olyan tulajdonságaiban történő változtatásokért, amelyek nem befolyásolják lényeges módon annak rendeltetését vagy a felhasználás módját;

4) nem vállal felelősséget a jelen katalógusban lévő információk pontatlanságáért;

5) nem vállal felelősséget azokért az esetleges károkért, amik az áruknak a fényképeken látható tulajdonságoktól eltérő tulajdonságokkal történő leszállításából erednek.

II. A TOYA S.A. minden igyekezete ellenére nem tudja garantálni, hogy a jelen katalógusban

található információk teljes egészében megfelelnek a valóságnak.
III. A tárgyi katalógusban található információk alapján meghozott bármilyen döntés annak a személynek a rizikója, aki ezeket az információkat felhasználja.

RO

I. TOYA S.A. informează că:
1) prezentul cataog nu constituie ofertă în înțelesul dreptului civil;
2) articolele prezentate în prezentul catalog se pot diferi față de mostrele din fotografiile, în special aspectul exterior, adică mărimea, culoarea, modul de ambalare, cantitatea obiectelor în ambalaj;
3) nu-și asumă răspunderea referitor la mici diferențe la modul de ambalare sau la articole al căror proprietăți nu au influență referitor la destinația sau modul lor de utilizare;
4) nu-și asumă răspunderea referitor la orice inexactitate sau imprecizie, datorită informațiilor cuprinse în catalogul respectiv;
5) nu-și asumă răspunderea referitor la o eventuală pagubă ca urmare primirii marfei cu alte proprietăți decât cele prezentate pe fotografii;
II. Cu toate strădanile TOYA S.A., firma nu poate garanta că, informațiile din prezentul catalog corespund realității;
III. Orice decizie preluată în baza informațiilor cuprinse în catalogul respectiv, sunt preluate pe riscul și răspunderea persoanei care a făcut folos de aceste informații.

E

I. TOYA S.A. comunica lo siguiente:
1) el presente catálogo no constituye una oferta, en el sentido que la noción adquiere en la ley civil;
2) los artículos presentados en el presente catálogo pueden en realidad diferir de los modelos indicados en las fotografías, especialmente en cuanto a sus propiedades externas, es decir el tamaño, el color, el empaque o la cantidad de los objetos en el empaque;
3) la empresa no se hace responsable por pequeñas diferencias en cuanto al empaque o las propiedades de los artículos, siempre y cuando estas diferencias no afectan el propósito o el modo de operación de las herramientas;
4) la empresa no se hace responsable por ninguna imprecisión en cuanto a la información presentada en el presente catálogo;
5) la empresa no se hace responsable por ningún daño que surja del hecho de que los artículos recibidos difieran de los artículos presentados en las fotografías en cuanto a sus propiedades.
II. A pesar de los mejores intentos de parte TOYA S.A. la empresa no puede garantizar que la información presentada en el presente catálogo corresponda completamente a la realidad.
III. Todas las decisiones tomadas en base a la información presentada en el presente son responsabilidad de la persona que recurra a la dicha información.

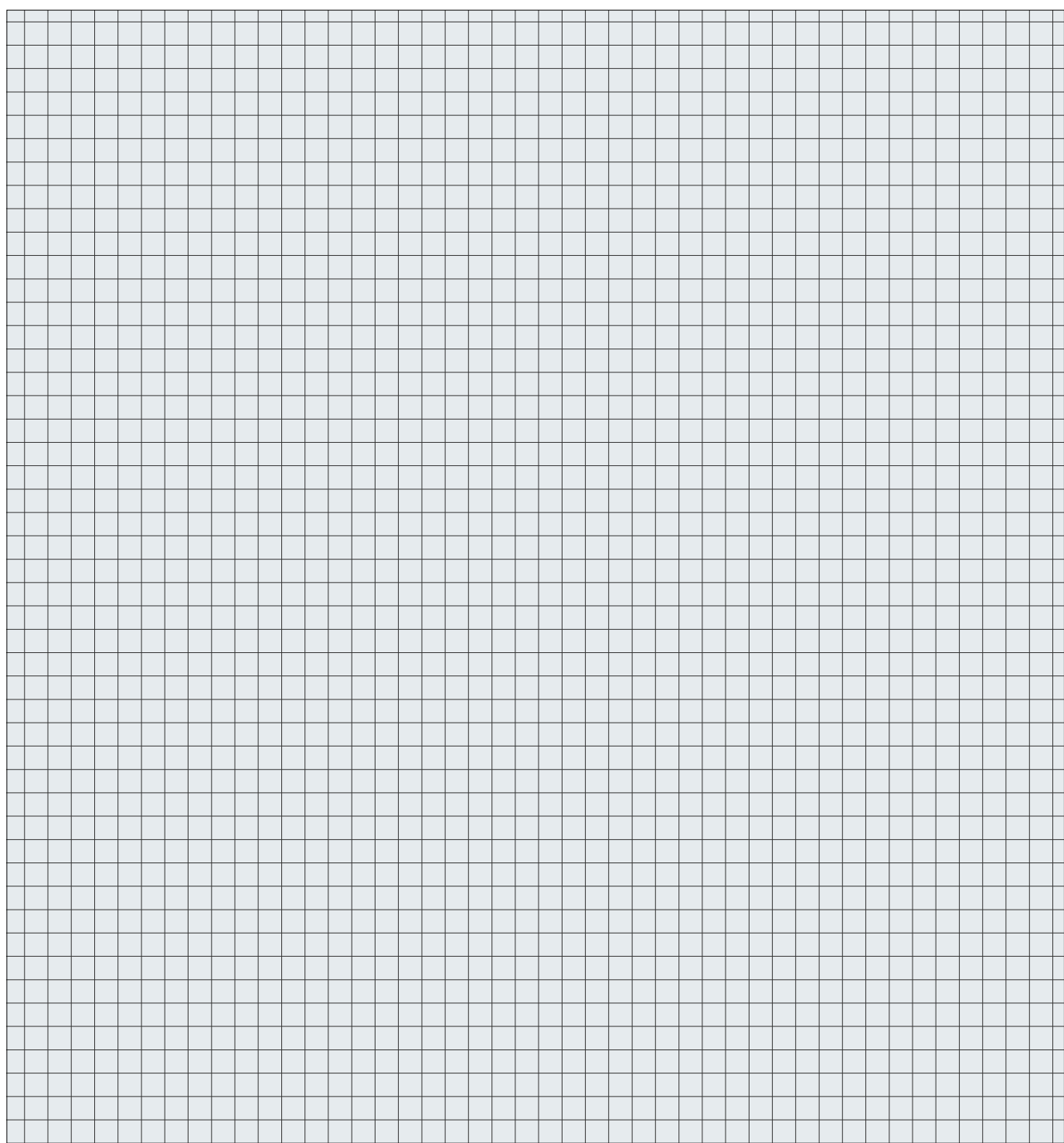

PACKING DESCRIPTION



Colour box



Box with colour label



PVC colour box



Box



Blister card



Double blister card



Double blister transparent



Half double blister card



Sliding card



Plastic hanger



Hanging card



Header card



Tied on card



Skin card



Polybag with header card



Polybag



Polybag with printed header



Polybag with hanger



Sleeve



Carton envelope



Bulk



Plastic holder



Flag tied on card



Metal box



Metal box with colour label



Metal box with sleeve



Plastic box



Plastic box with colour sleeve



Plastic case with colour label



Plastic case with label



Plastic case with colour sleeve



Plastic tube with colour label



Metal clip



Wooden box with sleeve



Pouch



Shrink card / Plastic tray