



SINCE 1990



H.C.B-D1159



HWANG CHERNG BIN

Specialty Tools Inc.

COMPANY PROFILE

Founded in 1990, HWANG CHERNG BIN (H.C.B) Specialty Tools Inc. plays an innovative role in special automotive, truck tools and equipments. We developed tools for many car and truck manufacturers such as Mercedes-Benz, BMW, Scania, Volvo, Hino, Fuso, Volkswagen, Audi, Honda....., etc. Our tool range is wide. It covers engine, transmission, panel, and wheel, especially chassis.

The factory of H.C.B occupies around 4 thousand square meters. This spacious factory has various facilities, including testing lab, R&D lab, sample room, training room, and employee break room which can help staff increase their working efficiency effectively.

In Taiwan, HCB, one of the world's leading manufacturers. We used to be a specialist in automotive tools. Now we're not only a specialist in automotive tools, but also in truck tools. We are the only truck tools R&D Company in Taiwan which accesses governmental allowance for designing new products.

When looking for optimal and professional vehicle repair tools, the first choice throughout the world is always H.C.B tools.

The primary goal of H.C.B is to make vehicle repair safer, easier, and faster. Furthermore, make it more economical.

In order to keep up with market trend, H.C.B has a professional R&D team which has developed over 7 hundred kinds of tools. Besides, for now H.C.B has more than 80 patents in Taiwan, Germany, U.S.A, and Japan. More importantly, our quality earns ISO 9001/CE/TUV approval to ensure our product's great quality.





Brand Story

台灣1990年代

在全球化的加速發展下，國際競爭力已成為工商企業存在與繁榮的關鍵因素。

In 1990's Taiwan.

Under the accelerated development of globalization, the international competitiveness of businesses has become a key in the existence and prosperity.

Taiwan in den 80ern

Unter der beschleunigten Entwicklung der Globalisierung hat sich die internationale Wettbewerbsfähigkeit der Unternehmen zu einem Schlüssel zu Existenz und Wohlstand entwickelt.

由於面臨國內產業外移腳步加快，大廠外移的處境，原本創立於1990/05/01以接單製造機械零件加工之業務為主的鉅祥公司面臨到了訂單縮減的重大問題，但危機未嘗不是轉機？

Faced with the acceleration of the domestic industry relocation, Gu Siang Tools Develop Co., Ltd., founded in 1990/05/01 and doing the manufacture of mechanical parts processing, faced with losing orders. But a crisis is also a turning point, isn't it?

Mit Blick auf die heimische Industrie um den Standort voran zu bringen, wurde Gu Siang Tools Co. Ltd. zur Herstellung und Verarbeitung mechanischer Teile am 05.01.1990 gegründet, trotz verringerter Bestellungen. Aber ist eine Krise nicht auch ein Wendepunkt?

契機來的突然，黃盛彬先生某日接獲友人來電說道：「友人因苦惱修車時遇到無法將零件拆卸更換的問題，所以希望黃盛彬先生可以幫忙解決。」黃盛彬先生熱心助人並馬上前往查看，苦思許久後製作出了修護工具並解決朋友的問題。

Opportunity came suddenly, Mr. Hwang Cherg Bin received a call for help one day. It was from a friend who was distressed about how to disassemble and replace parts of the car. Mr. Hwang went and checked. After thinking for a while, Mr. Hwang came up with an idea that he could produce repair tools to solve the problem. And finally Mr. Hwang solved the friend's problem.

Die Gelegenheit kam plötzlich als Mr. Hwang Cherg Bin eines Tages einen Hilferuf eines Freundes bekam, der verzweifelt war wie man Teile auseinander baut und sie ersetzt. Mr. Hwang ging, prüfte und kam nach langer Zeit wieder um ein Reparaturwerkzeug zur Problemlösung herzustellen.

友人感謝之餘，希望向黃盛彬先生購買此修護工具，黃盛彬先生才恍然大悟或許這是可以解決公司面臨訂單縮減的契機，非常感念友人給予的契機。

This friend thanked and would like to purchase this repair tool. Mr. Hwang suddenly realized this can save the company from facing reduction of orders. Until now, Mr. Hwang has an immense gratitude to this friend for the opportunity he gave.

Dieser Freund bedankte sich und wollte gerne das Reparaturwerkzeug kaufen. Mr. Hwang dämmerte, dass das der Firma helfen kann um den verringerten Bestellungen entgegenzuwirken. Bis heute ist Herr Hwang diesem Freund für diese Möglichkeit sehr dankbar.

鉅祥公司致力於汽車修護工具之製造加工，品質長期受業界肯定，於西元2000年自創H. C. B AUTO TOOLS品牌，並開發BENZ及BMW汽車特殊修護工具為主要目標，提高產品附加價值，另一方面持續開發卡車特殊修護工具、引擎、底盤、輪胎定位、鈹金修護工具，品質優良，造福保養汽車同業，頗受好評。

此外，鉅祥公司也是台灣唯一的卡車工具研發廠商並且榮獲了政府補助。

After that, Company has been concentrating on the production for a wide range of Auto Maintenance Tools and thus built up OBM-H.C.B SPECIALTY TOOLS. H.C.B regards the design and development of BENZ & BMW repair tools as primary object to increase the value of products. On the other hand, company continues to develop special truck repair tools for engines, chassis and tire position. As a result of our high quality products and outstanding customer service, H.C.B has gained a global sales network reaching all over the world. Not only well appreciated by purchasers, but also HCB accesses government subsidies because HCB is the only truck repairing tool manufacturer in Taiwan.

Seitdem ist die Firma mit der Produktion eines weiten Spektrums von Kfz-Wartungswerkzeugen beschäftigt und gründete OBM-H.C.B SPEZIALWERKZEUGE.

H.C.B. ist mit dem Design und der Entwicklung von Kfz-Reparaturwerkzeugen für BENZ & BMW beschäftigt. Auf der anderen Seite setzt das Unternehmen die Entwicklung spezieller Reparaturwerkzeuge für LKW, Motoren, Karosserie und Fahrwerk fort. Als Ergebnis unserer hohen Produktqualität und unseres Kundenservice, hat H.C.B. ein globales Vertriebsnetzwerk erreicht. Nicht nur von seinen Kunden geschätzt, sondern auch der einzige Hersteller von LKW Reparaturwerkzeugen mit Zugang zu staatlichen Subventionen.

1990~1999



- 創立鉅祥工業社(董事長 黃盛彬 先生)(1990.5.1)
Mr. Hwang Cherng Bin built up Gu Siang industrial Co. 台灣嘉義県にて鉅祥工業社として黄盛彬が会社創設・創業者 黄盛彬 会長に就任 (1990.5.1)
- 開始代工多國品牌汽修工具
Started out doing OEM works for many countries.
自動車用修復工具の改良ニーズへの対応OEM・海外代理店問合せを始める。
- 開発第一組 BENZ底盤修護工具(H.C.B-A1001) USA.PAT. (1998.7.20), 迄今約有80多項專利(含歐、美、日)
Develop first BENZ chassis repair tool(H.C.B-A1001) USA.PAT. (1998.7.20), and awarded 80 patents from Germany, America, Japan and Taiwan.
ベンツシャーシ修復ツールの開発に世界で初めて成功し、80項目の特許を取得しました。
米国(1998.7.20) 德国・日本の特許を取得する。そして多国の実用新型特許を取得した。
- 以H.C.B品牌在國內市場銷售
Sale H.C.B brand in domestic market.
自動車用修復工具にH.C.Bのマークを使用することを決定。そして市販を開始。
BENZ 工字標鐵套通過專利審查(1999.03.09)
BENZ Suspension bush extractor/installer was awarded patent.
ベンツ(W124/W201)サスペンションブッシュ抽出器の發明專利(台湾)を正式に取得しました。
- 商標HCB註冊和公司開始參與主要生產專業工具 (1999.09.01)
The trademark H.C.B was registered and the Company became involved mainly in manufacturing professional tools. (1999.09.01)
H.C.B 商標專売特許權を審査成功。



2012

- 以H.C.B品牌 正式進入歐洲市場
Sale H.C.B brand in Europe Markets.
自動車用修復工具にH.C.Bのマークを使用することを決定。そして歐洲市販事業との直接取引開始。
- 取得 CE認證 (H.C.B-A1383 電動鉚釘機)
電気ブレーキライニングシューローダーは CE証明書を得了。
- 取得 CE認證 (H.C.B-A8001多功能剪型氣/油壓引擎拆卸設備)
マルチファンクション油圧/空圧エンジンリフトは CE証明書を得了。
- 榮獲101年生產革新管理聯合型輔導計畫績優獎
台湾の工業生産管理推進機構育成計画の取り組みを表彰する。
- 榮獲台灣發明專利20年 (H.C.B-B1337 電動卡車引擎拆裝架)
齒車式ユニバーサルK/Dラックは台湾の研究開発特許權20年を取得。
- 榮獲” 新型專利號碼 PAT.M 438423(H.C.B-A1410 萬用球接頭拆卸器(39mm))
ユニバーサルトラックボールジョイントリムーバー(39ミリメートル)は商品新型特許權を取得。
- 榮獲” 新型專利號碼 (H.C.B-A1445 獲得新型專利)
ユニバーサルサスペンションアームレバーは商品新型特許權を取得。



2013~2014

- 榮獲 專利 (H.C.B-A1445 撬棒)
Awarded Patent (H.C.B-A1445 UNIVERSAL SUSPENSION ARM LEVER)
ユニバーサルサスペンションアームレバーは特許を取得。
- 榮獲台灣專利 (H.C.B-A1487 BMW (E81-E88,E90-E93,F2,M3)後游臂鐵套拆裝工具組)
Awarded Taiwan Patent (H.C.B-A1487 BMW (E81-E88,E90-E93,F2,M3) REAR TRAILING ARM BUSHING REMOVER & INSTALLER TOOLS)
BMW E87/E88/E90-E93/F2/M3 リアトレーリングアームブッシュリムーバーとインストーラツールは台湾の特許を取得。
- 榮獲德國專利 (H.C.B-B1339 大王銷拆卸機 75噸)
Awarded Germany Patent (H.C.B-B1339 TRUCK KING PIN PRESS 75 TONS)
KING PINとアンカーピンプッシャー(75トン)はドイツの特許を取得。
- 榮獲美國專利 (H.C.B- B1117 專利引擎拆裝架)
Awarded Germany Patent (H.C.B- B1117 UNIVERSAL ENGINE STAND)
ギアタイプユニバーサルK/Dラック は米国特許を取得。
- 新廠動工(龍德二廠 2014.3.3)
Start building new company (Longder Second 2014.3.3)
本社の新工場龍德二廠で工場擴増開始。



1990

2002

2002~2006

- 開始參加臺北AMPA SHOW展覽與國外展覽, 成功將H.C.B品牌推廣到國際市場
Start to participate in Domestic and international exhibitions and successfully promoting H.C.B brand to international markets.
台北と海外國際展覽會を参りました。國際市販でH.C.Bのブランドを成功発売。
- 成立鉅祥工具開發有限公司 (原鉅祥工業社改制) (2002.4.23)
Founded Gu Siang Tools Develop Co. Ltd (Gu Siang industrial Co. reformed)(2002.4.23)
鉅祥工業社を有限公司鉅祥工具開發と改称。
- 正式與國立中正大學育成中心簽約合作 (2002.8.9)
Formal cooperation with the N.C.C.U (2002.8.9)
台湾の國立中正大學附中小企業創新育成センターと連携に関する協定を締結しました。
- 榮獲中小企業創新研究獎(嘉義縣工業會)
Awarded Taiwan SMEs Innovation Award (Chiayi County Industrial Associations)
台湾の中小企業庁で革新研究開発一等賞受賞。
- 榮獲 美國專利 (H.C.B-A1081 專利可調式皮帶盤支檔扳手)
Awarded USA Patent. (H.C.B-A1081 ADJUSTABLE UNIVERSAL CAMSHAFT PULLEY HOLDING TOOL)
ADJUSTABLE UNIVERSALカムシャフトプーリー保持具について、米国特許權を取得する。
- 榮獲 德國專利 (H.C.B-A1108 VW T4前上三角架球接頭拆裝工具組)
Awarded Germany Patent.(H.C.B-A1108 VW T4 FRONT AXLE UPPER BALL-JOINT EXTRACTOR/INSTALLER)
フロントアクスルアッパーボールジョイント抽出器について、ドイツ特許權を取得する。
- 入圍國家創新發明獎 (H.C.B-A1052雙A臂羊角校正器(改良型)
Entering National Invention and Creation Award (H.C.B-A1052) DOUBLE WISHBONE ALIGNMENT TOOLS (IMPROVEMENT)
国内で革新研究開発一等賞をファイナリストに。







2012

Company History

25 years of quality insisting and R&D



2009

-  榮獲AMPA SHOW創新發明獎配件類第一名 (H.C.B-A1081專利可調式皮帶盤支撐板手)
Got first in Taipei AMPA Innovation Awards (H.C.B-A1081 ADJUSTABLE UNIVERSAL CAMSHAFT PULLEY HOLDING TOOL)
アジャスタブルユニバーサルカムシャフトプーリーホールディングツールとは AMPAの革新一等賞を受賞しました。
-  榮獲由臺北國際汽車零配件展主辦的AMPA SHOW綠色能量推薦產品(H.C.B-A1052)雙A臂羊角校正器(改良型)
Awarded Taipei AMPA SHOW Green Power recommended product (H.C.B-A1052) DOUBLE WISHBONE ALIGNMENT TOOLS (IMPROVEMENT)
HONDA ホンダ修復ツールについて、台北國際自動車産業総合展のAMPA SHOWグリーン化製品をお薦めて最良の選択です。
-  榮獲由臺北國際汽車零配件展主辦的AMPA SHOW綠色能量推薦產品(H.C.B-A1117 專利齒輪式多功能拆裝架)
Awarded Taipei AMPA SHOW Green Power recommended product (H.C.B-A1117 GEAR TYPE UNIVERSAL K/D RACK)
ギアタイプユニバーサルK型(Dラック特許)について、台北國際自動車産業総合展のAMPA SHOWグリーン化製品をお薦めて最良の選択です。
-  榮獲由臺北國際汽車零配件展主辦的AMPA SHOW綠色能量推薦產品(H.C.B-A1108 VW T4前上三角架球接頭拆裝工具組)
Awarded Taipei AMPA SHOW Green Power recommended product (H.C.B-A1108 VW T4 FRONT AXLE UPPER BALL-JOINT EXTRACTOR/INSTALLER)
フロントアクスルアッパーボールジョイント抽出器について、台北國際自動車産業総合展のAMPA SHOWグリーン化製品をお薦めて最良の選択です。
-  投保100萬美元的產品責任險
Insured \$ 1,000,000 product liability insurance
製品責任保険100万 (米ドル)
-  獲得ISO9001:2008版認證稽核
Obtain ISO 9001: 2008 version certification company
Since 2009 our production processes have complied with the ISO 9001: 2008 Quality System standards
品質マネジメントシステム ISO9001:2008 認証取得。
-  榮獲嘉義縣政府98地方產業創新研發推動計畫(地方型SBIR)補助 (H.C.B-B1337 手動卡車多功能拆裝)
Obtain Chiayi County government local industrial innovation and R & D Promotion Program grants (local type SBIR)
(H.C.B-B1337 TRUCK K/D RACK - ELECTRICAL)
齒車式ユニバーサルK/Dラック(B1337)は台湾の自治區嘉義縣政府地域産業研究開発推進計画 (SBIR) 公的扶助支援產品。

2009

2010~2011

-  新廠啟用(龍德一廠 2010.2.7)
Start using new factory (Longder First 2010.2.7)
本社の新工場龍德一廠で工場稼働開始。
-  榮獲中天電視台(今日台灣)節目專題報導(2010.2.13)
Obtain Taiwan Today report of Cti TV (2010.2.13)
台湾の中天新聞台報道特集 なかで紹介した掲載頂きました。
-  榮獲嘉義縣政府99年度地方產業創新研發推動計畫(地方型SBIR)補助(H.C.B A1383 電動鉚釘機)
Obtain Chiayi County government local industrial innovation and R & D Promotion Program grants (local type SBIR) (H.C.B A1383 ELECTRICAL BRAKE LINING SHOE LOADER)
電気ブレーキライニングシューローダーは台湾の自治區嘉義縣政府地域産業研究開発推進計画(SBIR) 公的扶助支援產品。
-  H.C.B 商標在中國註冊成功(2011.1.28)
Exclusive right to use H.C.B registered trademark in China (2011.1.28)
中国でH.C.Bの商標専売特許権を審査成功。
-  榮獲100年度經濟部科技研究發展專案協助傳統産業技術開發計畫(CITD)補助
Obtain CITD Program grants in 2011.
經濟部の科学産業技術の發展開發推進計画 (CITD) 公的扶助支援產品。
-  第五次獲得嘉義縣工業會優良會員廠商表揚
Award Excellent Member recognition from Chiayi County Industrial Associations for fifth times.
第五回台湾の嘉義縣工業機構のメンバーの中で最も優れた会社のを表彰する。

2010

2016

-  H.C.B 將與萬能工商建教合作培養優秀人才
H.C.B cooperates with Wan-Neng Vocational High School to cultivate talents.
H.C.Bは萬能工商と契約し、優秀な人材の育成をしています。
-  H.C.B-A1117工具獲得全國高中職汽車科學生競賽指定比賽工具
H.C.B-A1117 is a appointed competition tool in domestic Department of Automotive Technology of senior high school.
H.C.BのA1117工具は全国の高校の自動車修理コンテストの指定工具に選ばれました。
-  H.C.B與萬能工商合作承辦104年度高級中等學校職業類科專任教師赴公民營機構研習活動(2015/12/03)。
H.C.B with Wanneng Industrial and Commercial Vocational High School organized the 2015th Senior \ High School Vocational Department Full-time Teacher to private and governmental organization Seminar.
H.C.Bと萬能工商協力し、104年度の高校職業專門科專任教師を公民營機構へ派遣し、研修活動を行いました(2015/12/03)。
H.C.B und das Wanneng Industrie- und Wirtschaftsgymnasium organisierten das 2015 Seminar der Oberstufen-Berufsabteilung Vollzeit Lehrer für private und staatliche Organisationen.
-  H.C.B與國立中正大學育成中心產學合作
H.C.B with National Chung Cheng University Innovation Incubation center industry-university cooperative project.
H.C.Bは国立中正大学教育センター産学と提携しました。

2016





SINCE 1990

HWANG CHERNG BIN
Specialty Tools Inc.

Photos inside our production facilities

SINCE 1990

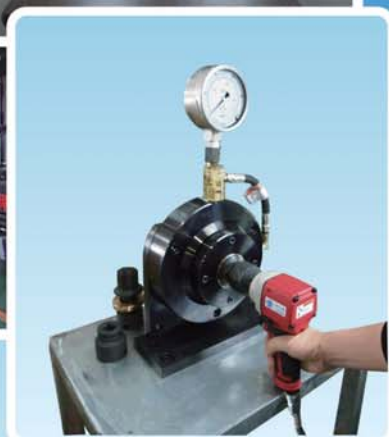



HWANG CHERNG BIN
Specialty Tools Inc.





HWANG CHERNG BIN
Specialty Tools Inc.

PATENT CERTIFICATE







010

HWANG CHERNG BIN
Specialty Tools Inc.

Index

BENZ CHASSIS REPAIR TOOL
賓士底盤修護工具 (P2~25)

PORSCHE TOOL
保時捷專區 (P216~221)

BENZ ENGINE REPAIR TOOL
賓士引擎修護工具 (P27~55)

HONDA REPAIR TOOL
HONDA 修護工具 (P223~232)

BENZ TRANSMISSION REPAIR TOOL
賓士引變速箱修護工具 (P57~62)

VOLVO REPAIR TOOL
VOLVO 修護工具 (P234~240)

BMW CHASSIS REPAIR TOOL
BMW 底盤修護工具 (P64~86)

GENERAL CHASSIS REPAIR TOOL
一般修護工具 底盤 (P242~269)

BMW ENGINE REPAIR TOOL
BMW 引擎修護工具 (P88~127)

GENERAL ENGINE REPAIR TOOL
一般修護工具 引擎 (P271~327)

BMW TRANSMISSION REPAIR TOOL
BMW 變速箱修護工具 (P129~133)

GENERAL TRANSMISSION REPAIR TOOL
一般修護工具 變速箱 (P329~333)

FORD REPAIR TOOL
福特修護工具 (P135~141)

GENERAL REPAIR EQUIPMENT
一般修護工具 修護設備 (P335~383)

VW REPAIR TOOL
福斯修護工具 (P143~195)

PANEL REPAIR TOOL
鈹金修護工具 (P385~404)

SUBARU REPAIR TOOL
SUBARU 修護工具 (P197~203)

AIR CONDITIONING REPAIR TOOL
冷氣修護工具 (P406~409)

SAAB REPAIR TOOL
SAAB 修護工具 (P205~206)

MACHINERY & HARDWARE
機械五金類 (P411~412)

LAND REPAIR TOOL
路虎 正時工具 (P208~214)

AIR POWER TOOL
氣動工具 (P414~417)



010
HWANG CHERNG BIN
 Specialty Tools Inc.

目錄索引
Index

Index

BENZ CHASSIS REPAIR TOOL
賓士底盤修護工具 (P2~25)

H.C.B-A1001 P002
 BENZ (W124) DIFFERENTIAL BUSH REMOVAL / INSTALLATION TOOL KIT
 PAT. 165163 USA PAT. 6389668
 BENZ (W124) 剋卸差速器·後三角架橡皮座鐵套拆裝工具組 (124 352 77 65)

H.C.B-A1002 P002
 BENZ REAR AXLES BUSH REMOVAL / INSTALLATION TOOL KIT
 PAT. 165163 USA PAT. 6389668
 BENZ 後羊角鐵套拆裝工具組 (全車系)

H.C.B-A1008-1 P002
 BENZ AXLES WHEEL BEARING REMOVAL / INSTALLATION TOOL KIT
 PAT. 201280 USA PAT.
 BENZ 免拆三角架前後輪軸承拆裝工具組

New H.C.B-B1008 P003
 UNIVERSAL AXLES WHEEL BEARING REMOVAL / INSTALLATION TOOL KIT
 PAT. 201280 USA PAT.
 通用免拆三角架前後輪軸承拆裝工具組

New H.C.B-A1641 P003
 UNIVERSAL LOCKING RING TOOL PAT.
 萬能扣環鉗

H.C.B-A1003 P004
 BENZ (W124/W201) SUSPENSION BUSH REMOVAL / INSTALLATION TOOL KIT PAT. 158341
 BENZ (W124/W201) 工字樑鐵套拆裝工具組

H.C.B-A1018 P004
 BENZ (W126) REAR AXLE FLANGE NUT SOCKET
 BENZ (W126) 傳動軸專用套筒

H.C.B-A1123 P005
 BENZ (W140) LOWER CONTROL ARM BUSH REMOVAL / INSTALLATION TOOL KIT (IMPROVEMENT)
 BENZ (W140) 三角架鐵套拆裝工具組 (改良型)

H.C.B-A1023 P005
 BENZ (W140) LOWER CONTROL ARM BUSH REMOVAL / INSTALLATION TOOL KIT (S-CLASS)
 BENZ (W140) 三角架鐵套拆裝工具組 (S系列)

H.C.B-A1024 P006
 BENZ (W210) LOWER CONTROL ARM BUSH REMOVAL / INSTALLATION TOOL KIT (NEW E-CLASS)
 BENZ (W210) 三角架鐵套拆裝工具組 (新E系列)

H.C.B-A1025 P006
 BENZ (W202/W170) LOWER CONTROL ARM BUSH REMOVAL / INSTALLATION TOOL KIT (C-CLASS)
 BENZ (W202/W170) 三角架鐵套拆裝工具組 (C系列)

H.C.B-A1480 P006
 COIL SPRING COMPRESSOR KIT (WISHBONE SUSPENSION)
 雙A臂避震器彈簧拆卸組

H.C.B-A1030 P007
 BENZ SPRING COMPRESSOR TOOL KIT
 BENZ 彈簧避震器拆裝工具組

H.C.B-B1040 P007
 BENZ (W203/W211) SPRING REMOVAL / INSTALLATION TOOL KIT PAT. 073953
 BENZ (W203/W211) 彈簧避震器拆裝工具組

H.C.B-C1047 P007
 BENZ (W204/X204/W212) COIL SPRING JAW KIT
 BENZ (W204/X204/W212) 更換避震器彈簧拆卸組

H.C.B-A1036 P007
 BENZ (W123/W126/W220) BALL JOINT REMOVAL / INSTALLATION TOOL KIT PAT. 179835
 BENZ (W123/W126/W220) 球接頭拆裝工具組

H.C.B-A1043 P008
 BENZ PARKING BRAKE INSTALLER
 BENZ 手煞車來令片固定彈簧扳手

H.C.B-A1044 P008
 BENZ WHEEL SUTD ALIGNMENT GUIDE TOOL (M12 x P1.5)
 BENZ 輪胎定位銷 (M12 x P1.5)

H.C.B-A1044-1 P008
 BENZ WHEEL STUD ALIGNMENT GUIDE TOOL (M14 x P1.5)
 BENZ 輪胎定位銷 (M14 x P1.5)

H.C.B-B1059 P008
 UNIVERSAL CALIPER PRESSURE TOOL (FOUR PISTONS)
 通用型分泵回復器 (4活塞)

H.C.B-A1059 P008
 BENZ CALIPER PRESSURE TOOL (FOUR PISTONS)
 BENZ 煞車分泵壓縮器 (4活塞)

H.C.B-A1068 P009
 BENZ (W140/W220) FRONT & REAR SUSPENSION BUSH REMOVAL / INSTALLATION TOOL KIT
 PAT. 158341
 BENZ (W140/W220) 工字樑前/後置鐵套拆裝工具組

H.C.B-A1082 P009
 UNIVERSAL BALL JOINT SEPARATOR KIT (24 mm)
 萬用球接頭拔卸組 (24 mm)

H.C.B-A1082-1 P009
 UNIVERSAL BALL JOINT SEPARATOR KIT (SCREW REPLACEABLE) (24 mm) PAT. 208928
 萬用球接頭拔卸組 (可替換螺絲) (24 mm)

H.C.B-A1083 P010
 UNIVERSAL BALL JOINT SEPARATOR KIT (21 mm)
 萬用球接頭拔卸組 (21 mm)

H.C.B-A1092 P010
 UNIVERSAL BALL JOINT SEPARATOR (W202/W210/W220) (24 mm)
 萬用球接頭拔卸組 (W202/W210/W220) (24 mm)

H.C.B-A1113 P010
 BENZ (W203/W209/R171) SUB-FRAME BUSH REMOVAL / INSTALLATION TOOL KIT
 BENZ (W203/W209/R171) 工字樑鐵套拆裝工具組

H.C.B-B1389 P011
 BENZ (W203/W204/W211/W212/W220/W221) FRONT SUB-FRAME BUSH REMOVAL/ INSTALLATION
 TOOL KIT (W/ HYDRAULIC CYLINDER) (Dr. 3/8") PAT.
 BENZ (W203/W204/W211/W212/W220/W221) 前三角架鐵套拆裝工具組 (油壓式) (3/8" 接頭)

H.C.B-A1389 P011
 BENZ (W203/W204/W209/W211/W212/W220/W221) FRONT SUB-FRAME BUSH REMOVAL /
 INSTALLATION TOOL KIT PAT. M412840
 BENZ (W203/W204/W209/W211/W212/W220/W221) 前三角架鐵套拆裝工具組

H.C.B-C1111 P012
 BENZ (W203/W204/W209/W211/W220) SUB-FRAME & BENZ (W211) FRONT SUSPENSION
 ARM BUSH REMOVAL / INSTALLATION TOOL KIT USA PAT. 6389668 PAT. 201280
 BENZ (W203/W204/W209/W211/W220) 三角架鐵套 & BENZ (W211) 前三角架懸掛控制臂
 鐵套拆裝工具組

H.C.B-A1111 P012
 BENZ (W203/W211/W220) SUB-FRAME BUSH REMOVAL / INSTALLATION TOOL KIT USA
 PAT. 6389668 PAT. 201280
 BENZ (W203/W211/W220) 三角架鐵套拆裝工具組

H.C.B-B1111 P012
 BENZ (W211) FRONT SUSPENSION ARM BUSH REMOVAL / INSTALLATION TOOL KIT
 BENZ (W211) 前三角架下控制臂鐵套拆裝工具組

H.C.B-A1341 P013
 BENZ (W210) REAR SUB-FRAME BUSH REMOVAL / INSTALLATION TOOL KIT
 BENZ (W210) 後工字樑鐵套拆裝工具組

H.C.B-B1461 P013
 BENZ (W221) WHEEL LUG SOCKET (17 mm) WITH PROTECTIVE SLEEVE
 BENZ (W221) 輪胎套筒 (17 mm) 含保護套



010
HWANG CHERNG BIN
 Speciality Tools Inc.

Index

H.C.B-A1461 P013	H.C.B-A2292 P019
BENZ (W221) WHEEL LUG SOCKET (17 mm) BENZ (W221) 輪胎套筒 (17 mm)	BRAKE CALIPER WIND BACK TOOL KIT (37 PCS) 剎車分泵調整組 (通用型)
New H.C.B-A1622 P014	H.C.B-A2017 P019
BENZ (W221) REAR SUBFRAME FRONT/REAR BUSH REMOVAL / INSTALLATION TOOL KIT BENZ (W221) 後工字樑前/後鐵套拆裝工具組	UNIVERSAL CALIPER WIND BACK KIT 碟式分泵調整組 (通用型)
New H.C.B-B1622 P014	H.C.B-A2117 P020
BENZ (W221) DIFFERENTIAL BUSH REMOVAL/INSTALLATION TOOL KIT BENZ (W221) 差速器鐵套拆裝工具組	18 PCS UNIVERSAL CALIPER WIND BACK KIT 18 PCS 煞車分泵調整組 (通用型)
New H.C.B-A1624 P015	H.C.B-A2135 P020
BENZ (W204) REAR SUBFRAME FRONT/REAR BUSH REMOVAL / INSTALLATION TOOL KIT BENZ (W204) 後工字樑前/後鐵套拆裝工具組	UNIVERSAL AIR POWERED DISC CALIPER WIND BACK KIT 氣壓碟刹分泵回復器
New H.C.B-B1624 P015	H.C.B-A2174 P021
BENZ (W204) DIFFERENTIAL BUSH REMOVAL/INSTALLATION TOOL KIT BENZ (W204) 差速器鐵套拆裝工具組	21 PCS UNIVERSAL BRAKE CALIPER WIND BACK KIT 21 PCS 煞車分泵調整組 (通用型)
H.C.B-A1119 P016	H.C.B-A1446 P021
BENZ (W220) SEAL TOP AIR SUSPENSION STRUT PAT. M253505 BENZ (W220) 氣壓避震器油封更換工具	BENZ (W211/W221/W215/W219/W220/W230) BALL JOINT SEPARATOR TOOL (HYDRAULIC) (10 TONS) BENZ (W211/W221/W215/W219/W220/W230) 球接頭工具 (油壓) (10 噸)
H.C.B-A1119-8 P016	H.C.B-A1535 P022
BENZ (W220) STRUT NUT SOCKET (OPTIONAL ACCESSORY) BENZ (W220) 氣壓避震器油封更換套筒 (選購配件)	BENZ (164.122/125/175/177/186/822/825/871) FREE WHEELING ADAPTER BENZ (164.122/125/175/177/186/822/825/871) 自由輪輔助器
H.C.B-A1140 P016	H.C.B-B1535 P022
BENZ ML RV SUSPENSION BUSH REMOVAL / INSTALLATION TOOL KIT PAT. 165163 USA PAT. BENZ ML 休旅車工字樑拆裝工具組	BENZ & BMW FREE WHEELING ADAPTER BENZ & BMW 自由輪輔助器
H.C.B-A1147 & A1148 P016	H.C.B-C2189 P023
BENZ SL DECAAGON STAR-SHAPE SPECIAL SOCKET BENZ SL 10角星型特殊套筒	BENZ M & R-CLASS BRAKE CALIPER WIND BACK SOCKET (1/2", 78 mm, H11) BENZ M & R-CLASS 煞車分泵拆卸套筒 (1/2", 78 mm, H11)
H.C.B-A1155 P017	H.C.B-A2189 P023
BENZ (W210/W202/W203/W140) REAR SUB-FRAME DIFFERENTIAL BUSH REMOVAL / INSTALLATION TOOL KIT USA PAT. BENZ (W210/W202/W203/W140) 差速器鐵套拆裝工具組	MERCEDES-BENZ M & R-CLASS BRAKE CALIPER WIND BACK SOCKET (H9) BENZ M & R-CLASS 煞車分泵拆卸套筒 (H9)
H.C.B-A1174 P017	H.C.B-A1369 P023
BENZ (W124/W129/W201) FRONT LOWER CONTROL ARM BALL JOINT REMOVAL / INSTALLATION TOOL KIT BENZ (W124/W129/W201) 前三角架下控制臂球接頭拆裝工具	BENZ SPRINTER REAR AXLES SOCKET BENZ SPRINTER 後羊角套筒
H.C.B-A1259 P017	H.C.B-A1377 P023
BENZ DRAG LINK PULLER BENZ 中段拉桿球接頭拆卸器	BENZ SPRINTER, VW LT BALL JOINT REMOVER (35 mm) PAT. M 362085 BENZ SPRINTER, VW LT 球接頭拔卸器 (35 mm)
H.C.B-A2136 P017	H.C.B-A2155 P024
BENZ (W163/W164) M-CLASS PIN WRENCH SOCKET (Dr. 3/4") BENZ (W163/W164) (ML) 休旅車羊角下球接頭拆裝套筒 (Dr. 3/4")	DRIVE SHAFT SPECIAL SOCKET KIT (Dr. 1/2") (5 PCS) 傳動軸專用套筒組 (Dr. 1/2") (5 PCS)
H.C.B-B2136 P018	H.C.B-B2155 P024
BENZ (W163/W164) M-CLASS PIN WRENCH SOCKET (Dr. 1/2") BENZ (W163/W164) (ML) 休旅車羊角下球接頭拆裝套筒 (Dr. 1/2")	DRIVE SHAFT SPECIAL SOCKET KIT (Dr. 1/2") (6 PCS) 傳動軸專用套筒組 (Dr. 1/2") (6 PCS)
H.C.B-E1168 P018	New H.C.B-D2155-27 P025
BENZ BALL JOINT REMOVAL / INSTALLATION TOOL KIT (COMPREHENSIVE) PAT. M333280 賓士綜合型球接頭拆裝工具組	DRIVE SHAFT SPECIAL SOCKET (12 POINT, SW 27 mm) 傳動軸專用套筒 (12角, SW 27mm)
H.C.B-A1168 P018	New H.C.B-D2155-31 P025
BENZ (W211/W215/W220/W230) BALL JOINT REMOVAL / INSTALLATION TOOL KIT PAT. M333280 BENZ (W211/W215/W220/W230) 前下球接頭拆裝器	DRIVE SHAFT SPECIAL SOCKET (12 POINT, SW 31 mm) 傳動軸專用套筒 (12角, SW 31mm)
H.C.B-B1168 P018	
BENZ (W220/W211) SUB-FRAME BALL JOINT REMOVAL / INSTALLATION TOOL KIT PAT. M333280 BENZ (W220/W211) 後三角架球接頭拆裝工具組	
H.C.B-D1168 P019	
BENZ (W163/W164) BALL JOINT REMOVER PAT. M333280 BENZ (W163/W164) 球接頭拆卸器	
H.C.B-A1318 P019	
BENZ (W211/W221/W164) AIR SUSPENSION PIPING SOCKET BENZ (W211/W221/W164) 避震器高壓風管拆卸套筒	



010
HWANG CHERNG BIN
 Specialty Tools Inc.

目錄索引
Index

Index

BENZ ENGINE REPAIR TOOL
賓士引擎修護工具 (P27~55)

H.C.B-A1468	P027	H.C.B-A1058	P031
BENZ & BMW GUIDE RAIL PIN SLIDE HAMMER PULLER KIT		BENZ (M111 / M112) CRANKSHAFT PULLEY HOLDER	
BENZ & BMW 內縫滑板插銷倒肩拉拔器組		BENZ (M111 / M112) 曲軸支撐扳手	
H.C.B-A1016	P027	H.C.B-A1099	P031
BENZ & BMW GUIDE RAIL PIN PULLER		BENZ (M112 / M113 / M137) CRANKSHAFT HARMONIC BALANCER PULLEY HOLDER	
BENZ & BMW 內縫滑板插銷拔卸器		BENZ (M112 / M113 / M137) 曲軸支撐扳手	
H.C.B-A1017	P027	H.C.B-B1099	P031
BENZ (W210) FUEL TANK LID REMOVER / INSTALLER		BENZ (M112 / M113 / M137) CRANKSHAFT HARMONIC BALANCER PULLEY HOLDER	
BENZ (W210) 塑膠汽油箱蓋拆裝工具		BENZ (M112 / M113 / M137) 曲軸支撐扳手	
H.C.B-A1039	P027	H.C.B-C1199	P031
BENZ (W202) FUEL TANK LID REMOVER / INSTALLER		BENZ (M271) CRANKSHAFT HARMONIC BALANCER PULLEY HOLDER	
BENZ (W202) 塑膠汽油箱蓋拆裝特種工具		BENZ (M271) 曲軸支撐扳手 (A 271 030 00 03)	
H.C.B-A1240	P028	H.C.B-A1199	P032
BENZ / BMW / VW FUEL TANK LID REMOVER / INSTALLER		BENZ (M271) CRANKSHAFT HARMONIC BALANCER PULLEY HOLDER	
BENZ / BMW / VW 塑膠汽油箱蓋拆裝器		BENZ (M271) 曲軸支撐扳手 (A 271 030 00 03)	
H.C.B-A1379	P028	H.C.B-B1199	P032
BENZ (W204 / W212), BMW (F10) FUEL TANK LID REMOVER / INSTALLER		BENZ (M271) CRANKSHAFT HARMONIC BALANCER PULLEY HOLDER	
BENZ (W204 / W212), BMW (F10) 汽油油箱蓋拆裝器		BENZ (M271) 曲軸支撐扳手 (A 271 030 00 03)	
H.C.B-A1399	P028	H.C.B-A1260	P032
BENZ (W164 / W251) FUEL TANK LID WRENCH (Dr. 1/2", 22 POINTS)		BENZ (642) CRANKSHAFT HUB LOCKING TOOL	
BENZ (W164 / W251) 汽油浮筒拆裝器 (Dr. 1/2", 22角)		BENZ (642) 曲軸支撐扳手	
H.C.B-A1022	P028	H.C.B-A1326	P032
BENZ & BMW FAN SERVICE WRENCH KIT (8 PCS)		BENZ (M272 / M273) CRANKSHAFT PULLEY HOLDING TOOL	
BENZ & BMW 專用風扇扳手組 (8 PCS)		BENZ (M272 / M273) 曲軸支撐扳手	
H.C.B-A1022(A)	P029	H.C.B-B1326	P033
BMW VISCOUS FAN NUT WRENCH (32 mm)		BENZ (M272 / M273) CRANKSHAFT PULLEY HOLDING TOOL	
BMW 風扇扳手 (32 mm)		BENZ (M272 / M273) 曲軸支撐扳手	
H.C.B-A1022(B)	P029	H.C.B-A1266	P033
BMW PULLEY HOLDER		ADJUSTABLE UNIVERSAL CRANKSHAFT PULLEY HOLDING TOOL	
BMW 風扇支撐扳手 (雙頭)		USA PAT.7069821 TW PAT.227176	
H.C.B-A1022(C)	P029	專利可調式皮帶盤支撐扳手	
MERCEDES-BENZ FAN CLUTCH WRENCH (65 mm)		H.C.B-A1268	P033
BENZ 風扇扳手 (65 mm)		BENZ (M112/M113/M272/M273) AIR CONDITIONING COMPRESSOR PULLEY HOLDING TOOL	
H.C.B-A1022(D)	P029	BENZ (M112/M113/M272/M273) 冷氣壓縮機皮帶盤支撐扳手	
BENZ REACTION WRENCH WITH 3 HOLES (Ø 10.3)		H.C.B-A1028	P033
BENZ 風扇支撐扳手 (3孔) (Ø 10.3)		BENZ (M102 / M103) VALVE SPRING COMPRESSOR	
H.C.B-A1022(E)	P030	BENZ (M102 / M103) 免折式汽門彈簧壓縮組	
BENZ VISCOUS FAN NUT WRENCH (36 mm)		H.C.B-A1267	P034
BENZ 風扇扳手 (36 mm)		BENZ VALVE SPRING COMPRESSOR	
H.C.B-A1022(F)	P030	BENZ 汽門彈簧壓縮桿	
BENZ HOLDING TOOL (L TYPE)		H.C.B-A1074	P034
BENZ 風扇支撐扳手 (L 型)		WEDGE KIT	
H.C.B-A1022(G)	P030	BENZ 門板拆卸器	
BENZ FAN BELT SERVICE WRENCH		H.C.B-A1074-1	P034
BENZ 風扇支撐扳手		HANDY REMOVER	
H.C.B-A1022(H)	P030	塑膠撬棒	
BENZ REACTION WRENCH WITH 3 HOLES (Ø 11.7)		H.C.B-A1074-2	P034
BENZ 風扇支撐扳手 (3孔) (Ø 11.7)		HANDY REMOVER	
H.C.B-A1022(I)	P031	塑膠撬棒	
VW / AUDI FAN CLUTCH WRENCH (46 mm)		H.C.B-A1074-3	P035
VW / AUDI 風扇扳手 (46 mm)		REMOVER WIDE TYPE	
		塑膠撬棒	
		H.C.B-A1074-4	P035
		REMOVER PULL TYPE	
		塑膠撬棒	
		H.C.B-B1074	P035
		5 PCS HANDY REMOVER KIT	
		5 PCS 塑膠撬棒組	

New



010
HWANG CHERNG BIN
 Speciality Tools Inc.

Index

H.C.B-G1074 P035	H.C.B-A1349 P041
5 PCS HANDY REMOVER KIT 5 PCS 塑鋼撬棒組	BENZ OIL PAN WRENCH (14 mm HEX x 17 mm BOX) BENZ 油底殼扳手 (14mm 六角凸 x 17 mm 六角孔)
H.C.B-P1074 P035	H.C.B-A1145 P041
5 PCS HANDY REMOVER KIT 5 PCS 塑鋼撬棒組	HEATED OXYGEN SENSOR SOCKET (Dr. 1/2", 22 mm) 含氧感應器套筒 (歐規) (Dr. 1/2", 22 mm)
H.C.B-C1074 P035	H.C.B-B1145 P042
MERCEDES-BENZ WEDGE REMOVER KIT (3 PCS) MERCEDES-BENZ 門板拆卸工具組 (3 PCS)	HEATED OXYGEN SENSOR SOCKET (Dr. 3/8", 22 mm) 含氧感應器套筒 (歐規) (Dr. 3/8", 22 mm)
H.C.B-T1074 P035	H.C.B-A1251 P042
MERCEDES-BENZ WEDGE REMOVER KIT (3 PCS) MERCEDES-BENZ 門板核桃木工具組 (3 PCS)	BENZ SPARK PLUG SOCKET (Dr. 3/8"x 5/8") (16 mm) BENZ 火星塞套筒工具 (Dr. 3/8"x 5/8") (16 mm)
H.C.B-A1103 P036	H.C.B-B1251 P042
BENZ (W140) DOOR PLANK EXTRACTOR BENZ (W140) 門板核桃木工具	SPARK PLUG SOCKET (Dr. 3/8", 12 POINTS, 14 mm) 萬用高效能火星塞套筒 (Dr. 3/8", 12 角, 14 mm)
H.C.B-A1067 P036	H.C.B-A1128 P042
BENZ ASSEMBLY SLEEVE FOR IGNITION BENZ 鎖頭外框套	MERCEDES-BENZ V6 ENGINE SPARK PLUG BOOT PULLER BENZ V6 火星塞高壓線扳手
H.C.B-A1241 P036	H.C.B-A1144 P043
BENZ IGNITION LOCK REMOVER BENZ 鎖頭拆卸器	BENZ (M111) OIL SEALING INSTALLER BENZ (M111) 油封安裝工具
H.C.B-A2233 P036	H.C.B-A1167 P043
RADIO DASHBOARD REMOVAL / INSTALLATION TOOL KIT (52 PCS) 儀錶板, 音響, 鎖頭, 拆裝工具組 (52 PCS)	SCANIA, BENZ (W203/ W209) WRENCH SOCKET (FLUID RESERVOIR ON CONDENSER) (Dr. 1/2", 27 mm) SCANIA, BENZ (W203/ W209) 冷凝器貯油槽套筒扳手 (Dr. 1/2", 27 mm)
H.C.B-C2003 P037	H.C.B-A1106 P043
RADIO REMOVAL TOOL KIT (20 PCS) 音響拆卸工具組 (20 PCS)	BENZ (M112 / M113) CAMSHAFT ALIGNMENT TOOL BENZ (M112 / M113) 凸輪軸正時工具組
H.C.B-A2003 P037	H.C.B-C1327 P044
BENZ DASHBOARD SERVICE TOOL KIT BENZ 儀錶板, 音響, 鎖頭拆裝工具組	BENZ AMG M156 TIMING TOOL KIT BENZ AMG M156 正時工具組
H.C.B-B2003 P037	H.C.B-D1159 P044
BENZ DASHBOARD SERVICE TOOL KIT (10 PCS) BENZ 儀錶板, 音響, 鎖頭拆裝工具組 (10 PCS)	BENZ (M271) ALIGNMENT TOOL KIT BENZ (M271) 正時工具組
H.C.B-A1072 P038	H.C.B-C1159 P045
BENZ (M271 / M272) OIL FILTER WRENCH (Dr. 1/2", 14 POINTS, 74 mm) BENZ (M271 / M272) 機油芯拆裝器 (Dr. 1/2", 14 角, 74 mm)	BENZ (M271) ALIGNMENT TOOL KIT BENZ (M271) 正時工具組
H.C.B-A1131 P038	H.C.B-A1420 P045
BENZ OIL FILTER WRENCH (Dr. 1/2", 14 POINTS, 74 mm) BENZ 機油芯扳手 (Dr. 1/2", 14 角, 74 mm)	BENZ (M137/M275/M285) TIMING TOOL KIT BENZ (M137/M275/M285) 正時工具組
H.C.B-A1243 P038	H.C.B-A1516 P045
BENZ ML, BMW OIL FILTER WRENCH (Dr. 1/2", 14 POINTS, 84 mm) BENZ ML, BMW 機油芯扳手 (Dr. 1/2", 14 角, 84 mm)	BENZ (M157/M276/M278) TIMING TOOL KIT BENZ (M157/M276/M278) 正時工具組
H.C.B-B1243 P039	H.C.B-A1524 P045
BENZ ML, BMW OIL FILTER WRENCH (Dr. 1/2", 14 POINTS, 84 mm) BENZ ML, BMW 機油芯扳手 (Dr. 1/2", 14 角, 84 mm)	BENZ (M133/M270/M274) ENGINE TIMING TOOL KIT BENZ (M133/M270/M274) 正時工具組
H.C.B-A1141 P039	H.C.B-A1546 P046
4 PCS OIL DIPSTICK KIT FOR BENZ 4 PCS BENZ 油尺組	BENZ DIESEL ENGINE TIMING TOOL KIT (M651) BENZ 柴油引擎正時工具組 (M651)
H.C.B-A1109 P040	H.C.B-B1546 P046
BENZ ENGINE OIL LEVEL GAUGE (STRAIGHT) BENZ 機油尺 (直型)	BENZ ENGINE TIMING TOOL KIT (M651) (2.0D / 2.2D / 2.5D) BENZ 柴油引擎正時工具組 (M651) (2.0D / 2.2D / 2.5D)
H.C.B-A1110 P040	H.C.B-C1546 P046
BENZ ENGINE OIL LEVEL GAUGE (VOLUTE) BENZ 機油尺 (渦型)	BENZ ENGINE TIMING TOOL KIT (M651) (1.8D / 2.0D / 2.2D / 2.5D) BENZ 引擎正時工具組 (M651) (1.8D / 2.0D / 2.2D / 2.5D)
H.C.B-A1249 P041	H.C.B-A1640 P046
BENZ OIL PAN WRENCH (14 mm HEX x 13 mm BOX) BENZ 油底殼扳手 (14 mm 六角凸 x 13 mm 六角孔)	BENZ (OM651) SWITCHING VALVE SOCKET (Dr. 1/2", 43.5 mm, 6 POINTS) BENZ (OM651) 機油洩壓閥套筒 (Dr. 1/2", 43.5 mm, 6角)

New

New

New



010

HWANG CHERNG BIN
Specialty Tools Inc.

目錄索引
Index

Index

H.C.B-A1436	P047	H.C.B-A2161	P051
BENZ (M271) CAMSHAFT FRONT GEAR WHEEL SOCKET (T100) BENZ (M271) 凸輪軸前皮帶齒輪套筒 (T100)		Dr. 1/2"x T50 STAR ALTERNATOR PULLEY REMOVER 發電機皮帶盤拆裝器	
H.C.B-A1330	P047	H.C.B-A1289	P051
BENZ TIMING LOCKING TOOL KIT BENZ 正時固定工具組 (固定飛輪用)		BENZ C32 (M111) W203 PULLEY RIVET INSTALLER BENZ C32 (M111) W203 機械增壓皮帶盤鎖釘座	
H.C.B-A1291	P047	H.C.B-C1293	P052
BENZ FLYWHEEL RETAINING LOCK TOOL BENZ 飛輪固定工具		BENZ TIMING CHAINS RIVETING TOOL KIT-SINGLE ROW AND DOUBLE ROW BENZ 鎖釘鏈條正時工具組-單排及雙排	
H.C.B-A1305	P047	H.C.B-B1299	P052
BENZ (M102/M103/M104/M111/M601/M602/M603/M605/M606/M611/M612/M613) FLYWHEEL LOCKING TOOL BENZ (M102/M103/M104/M111/M601/M602/M603/M605/M606/M611/M612/M613) 飛輪支撐器		BENZ CDI-ENGINES COMMON RAIL INJECTOR PULLER KIT (SLIDE HAMMER STYLE) BENZ 柴油引擎噴油嘴拉拔器 (滑槌式)	
H.C.B-A1334	P047	H.C.B-A1299	P052
BENZ CAMSHAFT LOCKING PIN BENZ 凸輪軸固定銷		BENZ INJECTOR NOZZLE PULLER (SLIDE HAMMER STYLE) BENZ 噴油嘴拔取器 (滑槌式)	
H.C.B-A2008	P048	H.C.B-A1589	P053
COOLING SYSTEM TESTER (14 PCS) 水箱壓力測漏組 (14 PCS)		BENZ (M271) INJECTOR NOZZLE REMOVER BENZ (M271) 噴油嘴拆卸器	
H.C.B-A2008-14	P048	H.C.B-B1589	P053
ACCESSORY FOR METROSTAR 福特天王星專用配件		BENZ (M271) INJECTOR NOZZLE REMOVER (W/SLIDE HAMMER) BENZ (M271) 噴油嘴拆卸器 (滑槌式)	
H.C.B-A2008-15	P048	H.C.B-A1598	P053
ACCESSORY FOR MAZDA MAZDA 專用配件		BENZ (M278) INJECTOR NOZZLE REMOVER BENZ (M278) 噴油嘴拆卸器	
H.C.B-A2008-16	P048	H.C.B-B1598	P053
ACCESSORY FOR BENZ (A-CLASS) BENZ (A-CLASS) 水箱蓋		BENZ (M278) INJECTOR NOZZLE INSTALLER BENZ (M278) 噴油嘴安裝器	
H.C.B-A2008-16T	P048	H.C.B-A2275	P053
ACCESSORY FOR TOYOTA (DIESEL) TOYOTA 專用配件 (柴油車)		4 PCS INJECTOR NOZZLE PULLER KIT 4 PCS 噴油嘴拉拔器	
H.C.B-A2008-17	P048	H.C.B-A1303	P054
ACCESSORY FOR BMW (E60/E63/E64/E65) (5 SERIES) BMW 5 系列水箱蓋 (E60/E63/E64/E65)		BENZ A/C LOW SIDE COUPLER REMOVER BENZ 冷氣低壓接頭拆卸器	
H.C.B-A2008-18	P048	H.C.B-A1613	P054
ACCESSORY FOR VW (SHARAN 1.8T 2.8) VW (SHARAN 1.8T 2.8) 水箱蓋		BENZ (M642) TIMING TOOL KIT BENZ (M642) 正時工具組	
H.C.B-A2008-19	P048	H.C.B-A1313	P054
ADAPTOR FOR BENZ SPRINTER BENZ SPRINTER 水箱蓋		BENZ (W124) STEERING OIL SEAL EXTRACTION / INSTALLATION TOOL KIT BENZ (W124) 方向機油封拆裝工具組	
H.C.B-A1255	P049	H.C.B-A1347	P054
13 PCS Dr. 1/2" ALTERNATOR INSERT BIT SOCKET KIT 發電機皮帶盤拆裝套筒組 (13 PCS)		BENZ (M271/M272) CRANKSHAFT REAR SEALING RING INSTALLER BENZ (M271/M272) 曲軸後油封安裝器	
H.C.B-B1255	P049	H.C.B-A1504	P054
22 PCS Dr. 1/2" ALTERNATOR INSERT BIT SOCKET KIT 發電機皮帶盤拆裝套筒組 (22 PCS)		BENZ POWER STEERING PUMP PULLEY BENZ 動力方向盤拆裝工具組	
H.C.B-D1255	P050	H.C.B-A1558	P055
30 PCS Dr. 1/2" ALTERNATOR INSERT BIT SOCKET KIT 發電機皮帶盤拆裝套筒組 (30 PCS)		BENZ CRANKSHAFT RADIAL SEAL INSTALLER BENZ 曲軸徑向密封環安裝工具	
H.C.B-A2251	P050	H.C.B-A1559	P055
40 PCS Dr. 1/2", SPECIAL INSERT BIT SOCKET KIT 發電機皮帶盤拆裝套筒組 (40 PCS)		BENZ (M651) CRANKSHAFT RADIAL SEAL INSTALLER BENZ (M651) 曲軸徑向密封環安裝工具	
H.C.B-A2186	P051	H.C.B-A1577	P055
BENZ ENGINE MOUNT WRENCH (16 mm) PAT.M365815 BENZ 引擎腳扳手 (16 mm)		BENZ VALVE ADJUST WRENCH (17 mm) BENZ 汽門調整扳手 (17 mm)	
H.C.B-A2187	P051	H.C.B-A1599	P055
BENZ ENGINE MOUNT WRENCH (17 mm) PAT.M365815 BENZ 引擎腳扳手 (17 mm)		BENZ REAR BUMPER SOCKET (10 mm, 120 mm, LONG SOCKET) BENZ 後保險桿套筒 (10 mm, 120 mm, 長套筒)	
		New H.C.B-A1644	P055
		FUEL LINE CONNECTOR PLIERS 汽油管接頭拆卸鉗	
		New H.C.B-A2314	P055
		CDI ENGINE GLOW PLUG TOOL CDI 引擎預熱塞工具	



010

HWANG CHERNG BIN

Specialty Tools Inc.

SINCE 1990

Index

BENZ TRANSMISSION REPAIR TOOL 賓士變速箱修護工具 (P57~62)

H.C.B-A1027-01-02-03-04-05	P057	H.C.B-A1208	P060
BENZ SLEEVE, ASSEMBLY DEVICE & ASSEMBLY FIXTURE BENZ 變速箱拆裝工具組		UNIVERSAL TRANSMISSION CLUTCH SPRING COMPRESSOR PAT. M317319 萬用變速箱離合器壓板拆裝器	
H.C.B-A1027-01	P057	H.C.B-A2036	P060
BENZ ASSEMBLY FIXTURE BENZ 變速箱離合器鼓活塞彈簧拆裝工具組		TRANSMISSION DEPTH GAUGE 變速箱深度量尺	
H.C.B-A1027-02	P057	H.C.B-B2054	P061
BENZ ASSEMBLY DEVICE BENZ 變速箱制動帶活塞彈簧工具		BENZ GEAR OIL PRESSURE GAUGE BENZ 變速箱壓力錶	
H.C.B-A1027-03	P057	H.C.B-A1290	P061
SLEEVE 變速箱橡膠圈拆卸工具組		UNIVERSAL TRANSMISSION & ENGINE PRESSURE TESTER 萬用型變速箱 & 引擎壓力錶	
H.C.B-A1027-04	P057	H.C.B-A1209	P061
SLEEVE 油封導管		BENZ 722.9 TRANSMISSION OVERFLOW PIPE REMOVER BENZ 722.9 變速箱油標拆卸器	
H.C.B-A1027-05	P057	H.C.B-B1209	P062
SLEEVE 油封導管		BENZ 722.9 TRANSMISSION OIL TOOL BENZ 722.9 變速箱油工具	
H.C.B-A1029	P058	H.C.B-A1333	P062
BENZ 722.6 & 722.9 SLEEVE, ASSEMBLY DEVICE & ASSEMBLY FIXTURE BENZ 722.6 & 722.9 變速箱拆裝工具組		BENZ TRANSMISSION GEAR LEVER RUBBER INSTALLER BENZ 變速箱排檔桿橡膠安裝器	
H.C.B-A1035	P058	H.C.B-A2230-T100	P062
GEARBOX K/D RACK (REAR) 多功能變速箱拆裝架		BENZ 722.9 TRANSMISSION SOCKET (Dr. 3/4", T 100) BENZ 722.9 變速箱套筒 (Dr. 3/4", T 100)	
H.C.B-A1035-1	P058	H.C.B-A2204	P062
ENGINE SUPPORTER 引擎支架		PNEUMATIC OIL & LIQUID DISPENSER (6000 c.c.) 吸排兩用液體分裝機 (6000 c.c.)	
H.C.B-A1035-2	P058		
SLOP OIL PAN 廢油盤			
H.C.B-A1035-3	P058		
REAR-WHEEL DRIVE TRANSMISSION HOLDER KIT TW PAT. USA PAT. 7093809 後透變速箱拆裝架			
H.C.B-A1037	P058		
BENZ ASSEMBLY SLEEVE BENZ 自動變速箱內部導向套管特殊工具組			
H.C.B-A1064	P059		
BENZ 722.3 & 722.5 SOCKET TOOL FOR PLUNGER BENZ 722.3 & 722.5 活塞外導向套筒			
H.C.B-A1042	P059		
BENZ (W124) RIVET INSTALLER K1, K2 BENZ (W124) 鐵圈內油封鉚釘安裝器			
H.C.B-A1042-1	P059		
BENZ (W126/W140) RIVET INSTALLER BENZ (W126/W140) 鉚釘安裝器			
H.C.B-A1042-3	P059		
RIVET 鉚釘			
H.C.B-A1094	P059		
BENZ 722.6 TRANSMISSION OIL LEVEL GAUGE BENZ 722.6 變速箱油尺			
H.C.B-A1146	P060		
BENZ 722.7 TRANSMISSION OIL LEVEL GAUGE BENZ 722.7 變速箱油尺			



010
HWANG CHERNG BIN
 Specialty Tools Inc.

目錄索引
Index

Index

BMW CHASSIS REPAIR TOOL
BMW 底盤修護工具 (P64~86)

H.C.B-A1004 P064
 BMW (E32/E34) UPPER SUB-FRAME BUSH EXTRACTOR / INSTALLER **PAT.165163. USA PAT.6389668**
 BMW (E32/E34) 上三角台鐵套拆裝工具組

H.C.B-A1034 P064
 BMW (E34) HUB REMOVER/ INSTALLER **PAT. 172921**
 BMW (E34) 輪軸拆裝工具組

H.C.B-A1038 P064
 BMW (E30/E36/E46) BUSH EXTRACTION / INSTALLATION TOOL KIT
 BMW (E30/E36/E46) 三角架鐵套拆裝工具組

H.C.B-C1168 P064
 BMW (E30/E36) LOWER CONTROL ARM BALL JOINT REMOVER/INSTALLER **PAT. M333280**
 BMW (E30/E36) 三角架球接頭拆裝工具組

H.C.B-A1460 P065
 BMW (E70) INSIDE SPRING VISE
 BMW (E70) 彈簧避震器拆裝工具組

H.C.B-A1047 P065
 MACPHERSON SPRING DAMPER EXTRACTION / INSTALLATION TOOL KIT (CHANGEABLE)
 麥花臣式彈簧避震器拆裝工具組 (可換式)

H.C.B-B1047 P065
 HEAVY DUTY MACPHERSON SPRING DAMPER EXTRACTOR (REPLACEABLE)
 重力氣動麥花臣彈簧壓縮器

H.C.B-A1047-F&G P066
 BMW (E39/E46) SPRING DAMPER EXTRACTION / INSTALLATION TOOL KIT (CHANGEABLE)
 BMW (E39/E46) 彈簧避震器拆裝工具組(可換式)

H.C.B-A1047-1 P066
 SPECIAL VISE FOR SHOCK ABSORBER
 麥花臣式彈簧拆裝工具固定座

H.C.B-A1047-2 P066
 SPECIAL VISE FOR SHOCK ABSORBER-RAPIDLY **PAT. M390257**
 快速型麥花臣式彈簧拆裝工具固定座

H.C.B-A1047-H P066
 EXTRA LARGE C JAW OF GM / CHRYSLER
 GM / CHRYSLER 大C型配件

H.C.B-C1087 P067
 BMW (E36/E46/E85) REAR AXLES BUSH REMOVAL/INSTALLATION TOOL KIT **USA PAT.**
 BMW (E36/E46/E85) 後羊角鐵套拆裝工具組

H.C.B-B1087 P067
 BMW (E46) REAR AXLE BUSH REMOVER /INSTALLER **USA PAT.**
 BMW (E46) 後羊角鐵套拆裝工具組

H.C.B-A1087 P067
 BMW (E36/E46/E85) REAR AXLES BUSH REMOVER/NSTALLER **USA PAT.**
 BMW (E36/E46/E85) 後羊角鐵套拆裝工具組

H.C.B-A1070 P068
 BMW (E38/E39/E52/E53/E60/E61/E63/E64/E65/E66/E67/E70) REAR AXLES BUSH REMOVER/
 INSTALLER **USA.PAT.6389668**
 BMW (E38/E39/E52/E53/E60/E61/E63/E64/E65/E66/E67/E70) 後羊角鐵套拆裝工具

H.C.B-A1089 P068
 UNIVERSAL AXLES OIL PRESSURE EXTRACTOR (REPLACEABLE)
 油壓輪軸拆卸組 (可換式)

H.C.B-B1095-4H P068
 SLIDE HAMMER PULLER FOR HUB EXTRACTION (4 HOLES FOR JAPANESE CARS)
 輪軸拔卸器 (4 孔, 日系車種)

H.C.B-B1095-5H P068
 BMW (E36/E46) SLIDE HAMMER PULLER FOR HUB EXTRACTION(5 HOLES FOR EUROPEAN CARS)
 BMW 全車系輪軸拔卸器 (5孔, 歐系車種)

H.C.B-C1095-5H P069
 BMW (E36/E46) SLIDE HAMMER PULLER FOR HUB EXTRACTION (5 HOLES FOR EUROPEAN CARS)
 BMW 全車系輪軸拔卸器 (5孔, 歐系車種)

H.C.B-D1095 P069
 UNIVERSAL HUB PULLER KIT (4 & 5 HOLES) (HYDRAULIC & SLIDE HAMMER)
 萬用型輪軸拔卸器 (4孔&5孔) (油壓式&滑錘式)

H.C.B-A1132 P069
 BMW (E46/E85) REAR SUB-FRAME DIFFERENTIAL BUSH EXTRACTOR / INSTALLER **USA PAT.**
 BMW (E46/E85) 差速器後三角架鐵套拆裝器

H.C.B-A1153 P069
 BMW (E46/E85) REAR SUSPENSION DIFFERENTIAL BUSH EXTRACTOR /INSTALLER **USA PAT.**
 BMW (E46/E85) 工字樑後橫樑差速器鐵套拆裝工具組

H.C.B-A1044-2 P070
 BMW WHEEL STUD ALIGNMENT TOOL (M14 x P1.25)
 BMW 輪胎定位銷 (M14 x P1.25)

H.C.B-B2174 P070
 BMW EMF BRAKE CALIPER WIND BACK KIT
 BMW EMF 煞車分泵調整組

H.C.B-A1647 P070
 BMW (E60) AFS GAUGE
 BMW (E60) AFS 校正器

H.C.B-C1264 P071
 MINI COOPER (R50/R52/R53/R55/R56/R57/R58/R59) FRONT AXLE CONTROL ARM RUBBER
 MOUNT KIT
 MINI COOPER (R50/R52/R53/R55/R56/R57/R58/R59) 前三角架橡皮座拆裝工具組

H.C.B-A1487 P071
 BMW (E81-E88,E90-E93,F2,M3) REAR TRAILING ARM BUSHING REMOVER/INSTALLER **PAT. M459082**
 BMW (E81-E88,E90-E93,F2,M3) 後仰角鐵套拆裝工具組

H.C.B-A1570 P071
 BMW (E90/M3) FRONT UPPER SUBFRAME BUSHING EXTRACTOR /INSTALLER KIT
 BMW (E90/M3) 上三角台鐵套拆裝工具組

H.C.B-A1216 P072
 BMW AXIAL CLEARANCE SEPARATOR (L TYPE)
 BMW 仰角間隙撐開器 (L 型)

H.C.B-A1206 P072
 BMW (E39) BALL JOINT SEPARATOR (24 mm)
 BMW (E39) 球接頭拆卸器 (24 mm)

H.C.B-A1154 P072
 BMW (E28/E34) REAR SUB-FRAME DIFFERENTIAL BUSH REMOVER / INSTALLER **USA PAT.**
 BMW (E28/E34) 後三角架鐵套拆裝工具組

H.C.B-A1158 P073
 BMW (E46/E85) REAR SUSPENSION BUSH EXTRACTOR / INSTALLER **PAT. M296813**
 BMW (E46/E85) 後工字樑鐵套拆裝工具組

H.C.B-B1201 P073
 BMW (X1/X3/X5/X6) TRANSMISSION RUBBER MOUNT BUSH EXTRACTOR / INSTALLER
 BMW (X1/X3/X5/X6) 變速箱橡膠支座拆裝工具組

H.C.B-A1201 P074
 BMW (X5) TRANSMISSION RUBBER MOUNT BUSH EXTRACTION / INSTALLATION TOOL KIT
 BMW (X5) 變速箱橡膠支座拆裝工具組



010

HWANG CHERNG BIN
Specialty Tools Inc.

SINCE 1990

Index

H.C.B-A1185	P074	H.C.B-B1294	P081
BMW (E39) REAR SUSPENSION DIFFERENTIAL BUSH EXTRACTION/ INSTALLATION TOOL KIT BMW (E39) 後工字樑差速器鐵套拆裝工具組		BMW BALL JOINT PULLER (24 mm & 27 mm & 31 mm & 36 mm) BMW 球接頭拔卸組 (24 mm & 27 mm & 31 mm & 36 mm)	
H.C.B-B1211	P075	H.C.B-B1264	P081
BMW (E39) SEDAN AND WAGON REAR SUSPENSION BUSH EXTRACTOR/INSTALLER KIT BMW (E39) 轎車·休旅車後工字樑鐵套拆裝工具組		MINI COOPER (R50/R52/R53) LOWER CONTROL ARM FIXED BASE EXTRACTOR / INSTALLER MINI COOPER (R50/R52/R53) 三角架固定座拆裝器	
H.C.B-A1211	P075	H.C.B-D1332	P082
BMW (E39) REAR SUSPENSION BUSH EXTRACTOR / INSTALLER KIT BMW (E39) 後工字樑鐵套拆裝工具組		BMW (E38/E39/E46/E53/E60/E61/E63/E64/E65/E66/E67/E81/E83/E85/E86/E87/E90/E91/E92/E93) FRONT CAMBER ADJUSTER KIT BMW (E38/E39/E46/E53/E60/E61/E63/E64/E65/E66/E67/E81/E83/E85/E86/E87/E90/E91/E92/E93) 外傾角調整器	
H.C.B-A1258	P076	H.C.B-A1332	P082
BMW (E53) REAR SUSPENSION BUSH EXTRACTOR / INSTALLER BMW (E53) 後工字樑鐵套拆裝工具組		BMW (E60/E61/E63/E64) FRONT CAMBER ADJUSTER BMW (E60/E61/E63/E64) 外傾角調整器	
H.C.B-B1258	P076	H.C.B-B1332	P082
BMW X5 (E53) REAR SUSPENSION DIFFERENTIAL BUSH EXTRACTOR / INSTALLER BMW X5 (E53) 後工字樑差速器鐵套拆卸工具組		BMW (E38/E39/E46/E53/E65/E66/E67/E81/E83/E85/E87/E90/E91/E92/E93) FRONT CAMBER ADJUSTER BMW (E38/E39/E46/E53/E65/E66/E67/E81/E83/E85/E87/E90/E91/E92/E93) 外傾角調整器	
H.C.B-C1258	P077	H.C.B-C1332	P082
BMW X5 (E53) FRONT SUSPENSION DIFFERENTIAL BUSH EXTRACTOR / INSTALLER BMW X5 (E53) 前工字樑差速器鐵套拆卸工具組		BMW (E38/E39/E46/E53/E65/E66/E67/E81/E83/E85/E86/E87/E90/E91/E92/E93) FRONT CAMBER ADJUSTER BMW (E38/E39/E46/E53/E65/E66/E67/E81/E83/E85/E86/E87/E90/E91/E92/E93) 外傾角調整器	
H.C.B-A1555	P077	H.C.B-A1304	P083
BMW REAR DIFFERENTIAL SOCKET (PT55) BMW 後差速器套筒 (PT55)		BMW BALL JOINT EXTRACTOR (24 mm) BMW 球接頭拔卸器 (24 mm)	
New H.C.B-B2293	P077	H.C.B-B2189	P083
BMW INNER BEARING RACE EXTRACTOR KIT BMW 軸承內圈環拔卸器		BMW BRAKE CALLIPERS WIND BACK SOCKET (H7) BMW 煞車卡鉗拆卸套筒 (H7)	
H.C.B-A1568	P078	H.C.B-A2278	P083
BMW (F01/F02/F04/F06/F07/F10-F13/F18) DIFFERENTIAL REAR BUSH REMOVAL / INSTALLATION TOOL KIT BMW (F01/F02/F04/F06/F07/F10-F13/F18) 差速器(後)鐵套拆裝工具		6-POINT TAMPERPROOF™ SOCKET 六角超短起子套筒	
H.C.B-B1568	P078	H.C.B-A1455	P083
BMW (F01/F02/F04/F06/F07/F10-F13/F18) DIFFERENTIAL FRONT BUSH REMOVAL / INSTALLATION TOOL KIT BMW (F01/F02/F04/F06/F07/F10-F13/F18) 差速器(前)鐵套拆裝工具		BMW RIM LOCKS SOCKET (Dr. 1/2") (10T/17T/21T) BMW 防盜螺絲套筒 (Dr. 1/2") (10T/17T/21T)	
H.C.B-A1588	P078	H.C.B-A2288	P084
BMW (F01/F02/F04/F06/F07/F10-F13/F18) REAR SUSPENSION BUSH REMOVAL / INSTALLATION TOOL KIT BMW (F01/F02/F04/F06/F07/F10-F13/F18) 後工字樑鐵套拆裝工具組		BMW WHEEL LOCK SCREW SOCKET KIT (10 PCS) BMW 防盜螺絲套筒 (10 PCS)	
H.C.B-A1458	P079	H.C.B-B2288	P084
BMW (E87/E90) REAR SUSPENSION BUSH EXTRACTION/ INSTALLATION TOOL KIT BMW (E87/E90) 後工字樑鐵套拆裝工具組		BMW WHEEL LOCK SCREW SOCKET SET (20 PCS) BMW 防盜螺絲套筒組 (20 PCS)	
H.C.B-A1253	P079	H.C.B-C2288	P084
BMW OUTPUT SHAFT KIT BMW 輪軸拆裝工具組		VW WHEEL LOCK SCREW SOCKET KIT (23 PCS) VW 防盜螺絲套筒組 (23 PCS)	
H.C.B-B1253	P080	New H.C.B-F1129	P085
BMW ALUMINUM ALLOY HUB WASHER BMW 鋁合金輪軸墊塊		BMW (F01/F02/F07/F10/F11/F12/F13/F18) FRONT LOWER CONTROL ARM BUSH EXTRACTOR / INSTALLER (W/HYDRAULIC CYLINDER) (3/8" ADAPTOR) PAT. BMW (F01/F02/F07/F10/F11/F12/F13/F18) 前下三角架鐵套拆裝工具組 (液壓式) (3/8" 接頭) PAT.	
H.C.B-C1253	P080	H.C.B-D1129	P085
FLANGE HOLDING LEVER 支撐把手		BMW (E31/E32/E34/E38/E39/E53/E60/E65/E66/E70/E90/E91/E92/E93/M3) UPPER SUB-FRAME BUSH EXTRACTOR / INSTALLER (HYDRAULIC) (3/8" ADAPTOR) PAT. BMW (E31/E32/E34/E38/E39/E53/E60/E65/E66/E70/E90/E91/E92/E93/M3) 上三角架鐵套拆裝工具組 (液壓式) (3/8" 接頭)	
H.C.B-D1253	P080		
BMW OUTPUT SHAFT EXTRACTOR/ INSTALLER KIT BMW 輪軸拆裝工具組			
H.C.B-A1048	P080		
BMW (E30/E36) LOWER CONTROL ARM BALL JOINT REMOVER/ INSTALLER BMW (E30/E36) 三角架球接頭拆裝工具組			



010
HWANG CHERNG BIN
 Specialty Tools Inc.

目錄索引
Index

Index

H.C.B-B1129 P086

HYDRAULIC HAND PUMP (3/8" ADAPTOR)
 手搖幫浦 (3/8" 接頭)

H.C.B-A1129 P086

BMW (E31/E32/E34/E38/E39/E53/E60/E65/E66) UPPER SUB-FRAME BUSH EXTRACTION /
 INSTALLATION TOOL KIT (HYDRAULIC) (3/8"ADAPTOR) PAT.M277669 USA PAT.
 BMW (E31/E32/E34/E38/E39/E53/E60/E65/E66) 上三角台鐵套拆裝工具組 (液壓式)
 (3/8" 接頭)

H.C.B-A1596 P086

BMW (E46/E85) REAR SUSPENSION BUSH EXTRACTOR/INSTALLER
 BMW (E46/E85) 後工字樑鐵套拆裝工具

New

H.C.B-B1596 P086

BMW EXTENSION BAR
 BMW 延長桿

H.C.B-A1121-2 P090

SECONDARY CHAIN TENSIONER LOCKING PIN
 鏈條鬆緊器固定銷

H.C.B-A1121-3 P090

SECONDARY SPROCKET TOOL
 扣鏈齒輪工具

H.C.B-A1121-4 P090

PRIMARY CHAIN TENSIONER TOOL
 鏈條鬆緊器

H.C.B-A1121-5 P090

PULLER FOR CRANKSHAFT HUB
 曲軸中心拉拔器

H.C.B-A1121-6 P090

VANOS COMPRESSED AIR FITTING (U.S. STANDARD) (OPTIONAL ACCESSORY)
 氣壓連接頭 (美規) (選購配件)

H.C.B-M62 P091

BMW (M62) VANOS CAMSHAFT TOOL KIT
 BMW (M62) 雙可變汽門正時工具組

H.C.B-A1245 P091

BMW (M47T2/M54/M57TU/M57T2/M62/M62VAN/M67) TIMING PIN
 BMW (M47T2/M54/M57TU/M57T2/M62/M62VAN/M67) 正時插銷

H.C.B-A1021 P091

BMW (M60 / M62) CAMSHAFT LOCKING FIXTURE
 BMW (M60 / M62) 偏心軸正時

H.C.B-B1021 P091

BMW (M62) VANOS CAMSHAFT LOCKING FIXTURE
 BMW (M62) VANOS 凸輪軸正時工具組

H.C.B-C1021 P092

BMW (M62) VANOS TIMING SOCKET
 BMW (M62) VANOS 凸輪軸套筒

H.C.B-D1021 P092

BMW (M62/M54) VANOS SOLENOID SOCKET
 BMW (M62/M54) VANOS 電磁閥套筒

H.C.B-E1021 P092

BMW (M62) VANOS TENSIONING BRACKET
 BMW (M62) VANOS 正時工具 - 托架

H.C.B-F1021 P092

BMW (M62) SECONDARY CHAIN TENSIONER LOCKING SPRINGS (2 PCS/KIT)
 BMW (M62) 鍊條鬆緊器固定彈簧

H.C.B-G1021 P092

BMW (M60) VANOS TENSIONING BRACKET
 BMW (M60) VANOS 正時工具 - 托架

H.C.B-A1452 P092

BMW (M60) CAMSHAFT INSERTION TOOL
 BMW (M60) 凸輪軸正時工具

H.C.B-A1088 P093

BMW CAMSHAFT ALIGNMENT TOOL KIT
 BMW 綜合正時工具組 (全車系)

H.C.B-A1118 P093

BMW (E36/E39/E46), BENZ (W211/W203), VW, EUROPEAN CARS FUEL TANK LID REMOVER/
 INSTALLER
 BMW (E36/E39/E46), BENZ (W211/W203), VW, 歐洲車種汽油油箱蓋拆裝器

H.C.B-A1476 P093

BMW MOTORCYCLE OIL FILTER WRENCH (75 mm)
 BMW 機車機油芯扳手 (75 mm)

BMW ENGINE REPAIR TOOL
BMW 引擎修護工具 (P88~127)

H.C.B-A1019 P088

BMW (M40/M43/M70/M73) CAMSHAFT ALIGNMENT TOOL
 BMW (M40/M43/M70/M73) 正時工具組

H.C.B-M52TU P088

BMW (M52TU/M54/M56) CAMSHAFT ALIGNMENT TIMING TOOL MASTER KIT
 BMW (M52TU/M54/M56) 凸輪軸正時工具組

H.C.B-A1020 P088

BMW CAMSHAFT ALIGNMENT TOOL
 BMW 正時插銷 (全車系通用)

H.C.B-A1137 P088

BMW (M50/M52/S50/S52) SPROCKET EXTRACTOR/INSTALLER
 BMW (M50/M52/S50/S52) 正時齒輪拆裝器

H.C.B-A1033 P089

BMW (M42/M50) CAMSHAFT ALIGNMENT TOOL
 BMW (M42/M50) 偏心軸正時工具

H.C.B-A1121 P089

BMW (M52TU/M54/M56) TIMING TOOL
 BMW (M52TU/M54/M56) 雙可變汽門正時工具組

H.C.B-B1121 P089

BMW (M52TU/M54/M56) TIMING TOOL
 BMW (M52TU/M54/M56) 雙可變汽門正時工具組

H.C.B-A1121-1 P090

BMW (M50TU/ M52TU/ M54/ M56) DOUBLE VANOS SETUP BRACKET
 BMW (M50TU/ M52TU/ M54/ M56) 雙可變汽門工具



010
HWANG CHERNG BIN
 Speciality Tools Inc.

Index

H.C.B-A1130 P094	H.C.B-A1138 P098
BMW (N20/N26/N40/N42/N45/N46/N52/N55/N63) OIL FILTER WRENCH (Dr. 1/2", 16 POINTS, 86 mm)	BMW WINDSHIELD WIPER ARM REMOVER
BMW (N20/N26/N40/N42/N45/N46/N52/N55/N63) 機油芯扳手 (Dr. 1/2", 16 角, 86 mm)	BMW 雨刷臂拆卸工具組
H.C.B-N62&N73 P094	H.C.B-A1133 P098
BMW (N62/N73) TIMING TOOLS	BMW (M52TU/M54/M56) CRANKSHAFT HUB LOCKING TOOL
BMW (N62/N73) 正時工具組	BMW (M52TU/M54/M56) 曲軸支撐扳手
H.C.B-B1136 P094	H.C.B-A1453 P099
BMW (N62/N62TU/N73) CAMCARRIER TOOL KIT	BMW (W11/W17) CRANKSHAFT HOLDING TOOL
BMW (N62/N62TU/N73) 凸輪軸托架工具組	BMW (W11/W17) 曲軸支撐扳手
H.C.B-A1136 P094	H.C.B-A2080 P099
BMW (N62/N73) CAMSHAFT ALIGNMENT TOOL	BMW (E31/E38/E39) WIPER LINKAGE ASSEMBLY SOCKET (T80)
BMW (N62/N73) 正時工具組	BMW (E31/E38/E39) 雨刷連桿組套筒 (T80)
H.C.B-A1136-5 P095	H.C.B-A1156 P099
BMW (N20/N26/N40/N42/N45/N46/N52/N55/N62) CHAIN TENSIONER (OPTIONAL ACCESSORY)	BMW (N42/N46/N46T) CAMSHAFT ALIGNMENT TOOL
BMW (N20/N26/N40/N42/N45/N46/N52/N55/N62) 鏈條鬆緊器 (選購配件)	BMW (N42/N46/N46T) 正時工具組
H.C.B-A1136-6 P095	H.C.B-A1156-5 P100
BMW (N73) LEFT CYLINDER HEAD SOCKET	BMW (N42/N46/N46T) INTAKE/EXHAUST CAMSHAFT GAUGE
BMW (N73) 左側氣缸蓋拆裝套筒	BMW (N42/N46/N46T) 進/排氣前凸輪固定座
H.C.B-A1136-7 P095	H.C.B-A1156-6 P100
BMW (N62/N62TU/N73) GASKET & BOLT	BMW (N42/N46/N46T) CAMSHAFT TURNING WRENCH
BMW (N62/N62TU/N73) 墊圈 & 螺絲	BMW (N42/N46/N46T) 旋轉凸輪軸扳手
H.C.B-A1136-8 P095	H.C.B-A1156-7 P100
BMW (N62/N62TU/N73) FIXING CRANKSHAFT WRENCH	BMW (N42/N46/N46T) INLET CAMSHAFT FIXTURE
BMW (N62/N62TU/N73) 固定曲軸扳手	BMW (N42/N46/N46T) 偏心軸/凸輪軸固定支架
H.C.B-A1136-9 P095	H.C.B-A1156-8 P100
BMW (N62/N62TU/N73) ANGLE INDICATOR	BMW (N42/N46/N46T) INTERMEDIATE LEVER CLAMP
BMW (N62/N62TU/N73) 角度指針	BMW (N42/N46/N46T) 中間橫桿固定夾
H.C.B-A1136-10 P095	H.C.B-A1156-9 P100
BMW (N62/N62TU/N73) SOCKET (27 mm)	BMW (N42/N46/N46T) CAMSHAFT BRACKET MOUNTING FIXTURE
BMW (N62/N62TU/N73) 套筒 (27 mm)	BMW (N42/N46/N46T) 凸輪軸拆裝托架
H.C.B-A1136-11 P096	H.C.B-A1156-10 P101
BMW (M60/M62/M73/N62/N62TU/N73) ANGLE POSITION GAUGE	BMW (N42/N46/N46T) INTAKE/EXHAUST CAMSHAFT GAUGE
BMW (M60/M62/M73/N62/N62TU/N73) 角度盤	BMW (N42/N46/N46T) 進/排氣前凸輪固定座
H.C.B-C1136 P096	H.C.B-A1156-11 P101
BMW (N62/N73) VALVETRONIC TORSION LEVER	BMW (N42/N46/N46T) TORSION SPRING REMOVER/INSTALLER
BMW (N62/N73) 汽門彈簧扭轉扳手	BMW (N42/N46/N46T) 扭力彈簧拆卸器
H.C.B-B1451 P096	H.C.B-A1156-12 P101
New BMW (N63/N74/S63) TIMING TOOLS	BMW (N42/N46/N46T) SPRING REMOVAL / INSTALLATION PLIERS
BMW (N63/N74/S63) 正時工具組	BMW (N42/N46/N46T) 扭轉彈簧鉗
H.C.B-A1451 P096	H.C.B-B1156 P101
BMW (N63/N74/S63) TIMING TOOLS	BMW (N42/N46/N46T) PETROL TIMING TOOL KIT
BMW (N63/N74/S63) 正時工具組	BMW (N42/N46/N46T) 正時工具組
H.C.B-A1593 P097	H.C.B-C1156 P102
BMW (N63/S63) CAMSHAFT ALIGNMENT TOOL KIT	BMW (N42/N46/N46T) CAMSHAFT CARRIER BRACKET REMOVAL / INSTALLTION TOOL KIT
BMW (N63/S63) 凸輪軸正時工具組	BMW (N42/N46/N46T) 正時工具組
H.C.B-A1656 P097	H.C.B-A1188&A1188-3 P102
New BMW (N63) INJECTOR REMOVAL TOOL	BMW (N51/N52) TIMING TOOLS & PLUG MANDREL
BMW (N63) 噴油嘴拆卸工具	BMW (N51/N52) 正時工具組附插銷
H.C.B-A1331 P097	H.C.B-A1188-1 P102
BMW (M60/M62) CRANKSHAFT PULLEY HOLDING TOOL	BMW (N51/N52) CAMSHAFT ALIGNMENT TOOL
BMW (M60/M62) 曲軸支撐扳手	BMW (N51/N52) 正時工具 (含量規, 適配器, 卡座)
H.C.B-A1204 P098	H.C.B-A1188-2 P102
BMW A/C COMPRESSOR CLUTCH REMOVER	BMW (N51/N52) CAMSHAFT FIXING BASE
BMW 冷氣壓縮機離合器拆卸器	BMW (N51/N52) 凸輪軸固定座



010
HWANG CHENGBIN
 Specialty Tools Inc.

目錄索引
Index

Index

H.C.B-A1188-3 P102

BMW (N51/N52/N52K/N53/N54) PLUG MANDREL
 BMW (N51/N52/N52K/N53/N54) 正時插銷

H.C.B-A1188-4 P103

BMW (N53/N54) CAMSHAFT FIXING BASE
 BMW (N53/N54) 凸輪軸固定座

H.C.B-B1188 P103

BMW (N51/N52/N52K/N53/N54) TIMING TOOLS
 BMW (N51/N52/N52K/N53/N54) 正時工具組

H.C.B-I1188 P103

BMW (N51/N52/N52K/N53/N54/N55) TIMING TOOL KIT
 BMW (N51/N52/N52K/N53/N54/N55) 正時工具組

H.C.B-H1188 P103

BMW (N20/N51/N52/N52K/N52T/N55) INTERMEDIATE VALVETRONIC LEVER
 BMW (N20/N51/N52/N52K/N52T/N55) 汽門彈簧拆裝器

H.C.B-A1605 P104

BMW (N20/N47/N54/N55/N57/N63) ENGINE FUEL INJECTOR REMOVAL / INSTALLATION TOOL KIT
 BMW (N20/N47/N54/N55/N57/N63) 引擎噴油嘴拆裝工具 (綜合組)

H.C.B-A1526 P104

BMW (N55) FUEL INJECTOR REMOVAL/ INSTALLATION TOOL
 BMW (N55) 噴油嘴拆裝工具

H.C.B-A1539 P104

BMW (N20/N55) FUEL INJECTOR REMOVAL/ INSTALLATION TOOL
 BMW (N20/N55) 柴油噴油嘴拆裝工具

H.C.B-A1587 P104

BMW (N63) FUEL INJECTOR REMOVAL/ INSTALLATION TOOL
 BMW (N63) 噴油嘴拆裝工具

H.C.B-A1590 P104

BMW (N54) FUEL INJECTOR REMOVAL TOOL
 BMW (N54) 噴油嘴拆卸工具

H.C.B-A1556 P105

BMW (N20/N26/N52/N55) AND MINI COOPER (N13/N16) VALVE PRESSURE SPRING REMOVER/ INSTALLER
 BMW (N20/N26/N52/N55) AND MINI COOPER (N13/N16) 汽門彈簧壓縮拆裝工具

H.C.B-G1188 P105

BMW (N55) TIMING TOOL KIT
 BMW (N55) 正時工具組

H.C.B-G1188-1 & 6 P105

BMW (N55) CAMSHAFT GAUGE
 BMW (N55) 凸輪軸固定座

H.C.B-G1188-2 & 5 P105

BMW (N55) CAMSHAFT FIXING BASE
 BMW (N55) 凸輪軸固定座

H.C.B-G1188-3 P105

BMW (N51/N52/N52K/N53/N54/N55) PLUG MANDREL
 BMW (N51/N52/N52K/N53/N54/N55) 正時插銷

H.C.B-A1517 P106

BMW (N20/N26) TIMING TOOL KIT
 BMW (N20/N26) 正時工具組

H.C.B-A1517-1&5&6 P106

BMW (N20/N26) CAMSHAFT LOCKING TOOL
 BMW (N20/N26) 凸輪軸正時工具

H.C.B-A1517-2&7 P106

BMW (N20/N26) CAMSHAFT FIXING BASE
 BMW (N20/N26) 凸輪軸固定座

H.C.B-A1517-3 P106

BMW(N20/N26) ALIGNMENT PIN
 BMW(N20/N26) 正時插銷

H.C.B-E1188 P107

BMW (N51/N52) EXHAUST CAMSHAFT UPPER AND LOWER BEARING STRIP FIXTURE REMOVAL/ INSTALLATION TOOL
 BMW (N51/N52) 排氣凸輪軸上下支撐條固定拆裝器

H.C.B-A1550 P107

BMW (N54/N54T) EXHAUST CAMSHAFT REMOVAL/ INSTALLATION TOOL
 BMW (N54/N54T) 排氣凸輪軸上下支撐條固定拆裝器

New **H.C.B-A1657** P107

BMW (N55) EXHAUST CAMSHAFT TENSION TOOL
 BMW (N55) 排氣凸輪軸固定工具

H.C.B-F1188 P108

BMW (N51/N52) VACUUM PUMP SEALING CAP REMOVAL/ INSTALLATION TOOL
 BMW (N51/N52) 真空泵密封蓋拆裝器

H.C.B-A1553 P108

BMW (N20/N26/N55) FIXING TOOL
 BMW (N20/N26/N55) 固定工具

H.C.B-A1438 P108

BMW (N40/N42/N45/N45T/N46/N46T/N52/N53/N54) CRANKSHAFT FRONT/REAR OIL SEAL REMOVAL / INSTALLATION TOOL KIT
 BMW (N40/N42/N45/N45T/N46/N46T/N52/N53/N54) 曲軸前後油封拆裝工具組

H.C.B-C1188 P108

BMW (N40/N42/N45/N45T/N46/N46T/N52/N53/N54) CRANKSHAFT REAR OIL SEAL REMOVAL / INSTALLATION TOOL KIT
 BMW (N40/N42/N45/N45T/N46/N46T/N52/N53/N54) 曲軸後油封拆裝工具組

H.C.B-A1394 P109

BMW (N40/N42/N45/N45T/N46/N46T/N52/N52K/N53/N54) CRANKSHAFT FRONT OIL SEAL REMOVAL / INSTALLATION TOOL KIT
 BMW (N40/N42/N45/N45T/N46/N46T/N52/N52K/N53/N54) 曲軸前油封拆裝工具組

H.C.B-C1394 P109

BMW (N40/N42/N45/N45T/N46/N46T/N52/N52K/N53/N54/N55) CRANKSHAFT FRONT OIL SEAL REMOVAL / INSTALLATION TOOL KIT
 BMW (N40/N42/N45/N45T/N46/N46T/N52/N52K/N53/N54/N55) 曲軸前油封拆裝工具組

H.C.B-B1394 P109

BMW (N55) CRANKSHAFT FRONT OIL SEAL REMOVAL / INSTALLATION TOOL KIT
 BMW (N55) 曲軸前油封拆裝工具組

H.C.B-A1437 P110

BMW (M47/M47TU/S65/S85) OIL SEAL PULLER
 BMW (M47/M47TU/S65/S85) 正時齒輪油封拆卸器

H.C.B-A1464 P110

BMW (M47T2/M47TU/M57/M57D25/M57D30/M57T2/M57TU/M70/M73/S85) OIL SEAL PULLER
 BMW (M47T2/M47TU/M57/M57D25/M57D30/M57T2/M57TU/M70/M73/S85) 正時齒輪油封拆卸器

H.C.B-A1534 P110

BMW (N54) FRONT ENGINE SEAL REMOVER
 BMW (N54) 前引擎油封拆卸器

H.C.B-A1392 P110

BMW (N40/N45/N45T) PETROL ENGINE TWIN CAMSHAFT SETTING / LOCKING TOOL KIT
 BMW (N40/N45/N45T) 正時工具組

H.C.B-S85 P111

BMW (S85) CAMSHAFT ALIGNMENT TOOL KIT (E60/M5, E63/M6)
 BMW (S85) 凸輪軸正時工具組 (E60/M5, E63/M6)

H.C.B-A1250 P111

BMW (S85) CAMSHAFT TIMING TOOL
 BMW (S85) 凸輪軸正時工具



010
HWANG CHERNG BIN
 Speciality Tools Inc.

Index

H.C.B-B1250	P111	H.C.B-C1300	P118
BMW (S85) TIMING PIN BMW (S85) 正時插銷		MINI COOPER (N12/N14/N16) TIMING TOOL KIT MINI COOPER (N12/N14/N16) 正時工具組	
H.C.B-C1250	P111	H.C.B-A1300	P118
BMW (S85) VANOS CAMSHAFT GAUGE BMW (S85) 量規		MINI COOPER (N14) TIMING TOOL KIT MINI COOPER (N14) 正時工具組	
H.C.B-D1250	P112	H.C.B-B1300	P118
BMW (S85) VANOS CAMSHAFT GAUGE BMW (S85) 量規		MINI COOPER (N12) TIMING TOOL KIT MINI COOPER (N12) 正時工具組	
H.C.B-E1250	P112	H.C.B-A1518	P119
BMW (S85) VANOS TIMING SOCKET BMW (S85) VANOS 凸輪軸套筒		BMW (N13/N18) TIMING TOOL KIT BMW (N13/N18) 正時工具組	
H.C.B-A1198	P112	H.C.B-B2105	P119
MINI COOPER (R53) VIBRATION DAMPER TOOL MINI COOPER (R53) 曲軸支撐拔卸器		BMW CYLINDER HEAD BOLT REMOVAL AND INSTALLATION TOOL (Dr. 1/2", LENGTH: 200 mm, T40/T45/T50/T55/T60/T70) BMW 汽缸頭螺絲拆裝工具組 (Dr. 1/2", 長度: 200 mm, T40/T45/T50/T55/T60/T70)	
H.C.B-B1198	P113	H.C.B-A1224	P119
MINI COOPER (W11) CRANKSHAFT PULLEY PULLER MINI COOPER (W11) 曲軸皮帶盤拔取工具組		MINI COOPER (R50/R53) CAMSHAFT PULLEY TOOL KIT MINI COOPER (R50/R53) 皮帶盤工具組	
H.C.B-C1198	P113	H.C.B-A1288	P119
MINI COOPER (W11) CENTRAL HOLDING BOLT MINI COOPER (W11) 中心支撐螺絲		MINI COOPER (S/W11) SERPENTINE BELT TOOL MINI COOPER (S/W11) 皮帶拆裝工具	
H.C.B-D1198	P113	H.C.B-A1523	P120
MINI COOPER (R53/W11) CRANKSHAFT PULLEY PULLER MINI COOPER (R53/W11) 曲軸皮帶盤拔取器		MINI COOPER (N12/N14/N16/N18) SERPENTINE BELT TOOL MINI COOPER (N12/N14/N16/N18) 皮帶拆裝工具	
H.C.B-E1198	P114	H.C.B-A1309	P120
MINI COOPER (R53/W11) CRANKSHAFT PULLEY INSTALLER MINI COOPER (R53/W11) 曲軸皮帶盤安裝器		MINI COOPER (W10/W11) TIMING TOOL KIT MINI COOPER (W10/W11) 正時工具組	
H.C.B-A1408	P114	H.C.B-A1317	P120
BMW (M47T2/M47TU/M57T2/M57TU) V-BELT INSTALLER BMW (M47T2/M47TU/M57T2/M57TU) V 型皮帶安裝工具		MINI COOPER (N14) DOWN-PRESSED CAMSHAFT FIXED BASE MINI COOPER (N14) 下壓式凸輪軸固定器	
H.C.B-A1540	P114	H.C.B-B1317	P120
BMW (N47/N57) VIBRATOR DAMPER LOCKING REMOVAL / INSTALLATION TOOL KIT BMW (N47/N57) 曲軸支撐拆裝工具組		BMW (N14/M50/M52/S50) CAMSHAFT REMOVING FIXTURE BMW (N14/M50/M52/S50) 凸輪軸固定座	
H.C.B-A1542	P115	H.C.B-A1292	P121
BMW (E39/E46/E60/E61/E81/E83/E90/E91) CRANKSHAFT HARMONIC BALANCER PULLEY HOLDER BMW (E39/E46/E60/E61/E81/E83/E90/E91) 曲軸支撐扳手		BMW (N40/N42/N45/N46) BALANCE SHAFT LOCK PLATE - OLD STYLE BMW (N40/N42/N45/N46) 平衡軸正時工具 (舊型)	
H.C.B-B1542	P115	H.C.B-B1292	P121
BMW (E39/E46/E60/E61/E81/E83/E90/E91) CRANKSHAFT HARMONIC BALANCER PULLEY HOLDER (1/2") BMW (E39/E46/E60/E61/E81/E83/E90/E91) 曲軸支撐扳手 (1/2")		BMW (N45/N46/N46T) BALANCE SHAFT LOCK PLATE - NEW STYLE BMW (N45/N46/N46T) 平衡軸正時工具 (新型)	
H.C.B-A1262	P115	H.C.B-A1302	P121
BMW (M47/M57) DIESEL ENGINE CAMSHAFT ALIGNMENT TOOL BMW (M47/M57) 柴油引擎正時工具組		BMW (N12/N14/N16/N18/N40/N42/N45/N46/N52) CRANKSHAFT HUB LOCKING TOOL BMW (N12/N14/N16/N18/N40/N42/N45/N46/N52) 曲軸支撐扳手	
H.C.B-B1262	P116	H.C.B-A1311	P121
BMW (M41/M51/M47TU/M47T2/M57TU/M57T2) DIESEL TIMING TOOL KIT BMW (M41/M51/M47TU/M47T2/M57TU/M57T2) 柴油引擎正時工具組		BMW (M20/M40/M41/M43/M44/M50/M51/M52) CRANKSHAFT HUB LOCKING TOOL BMW (M20/M40/M41/M43/M44/M50/M51/M52) 曲軸支撐扳手	
H.C.B-C1262	P116	H.C.B-B1311	P121
BMW DIESEL 2.5TDS TENSIONER LEVER BMW 柴油 2.5TDS 正時鐘條壓縮器		BMW (M41/M43/M43TU/M44/M50/M52/M52TU/S52US) SPACER RING BMW (M41/M43/M43TU/M44/M50/M52/M52TU/S52US) 間格墊圈	
H.C.B-C1421	P116	H.C.B-A1316	P122
BMW (2.0 N47/3.0 N57) DIESEL ENGINE TIMING TOOL BMW (2.0 N57/3.0 N57) 柴油引擎正時工具		BMW (N43) TIMING TOOL KIT BMW (N43) 正時工具組	
H.C.B-B1421	P117		
BMW (2.0 N47/3.0 N57) DIESEL ENGINE CRANKSHAFT LOCKING TOOL BMW (2.0 N47/3.0 N57) 柴油引擎曲軸固定工具			
H.C.B-A1421	P117		
BMW (N47/N47S) DIESEL ENGINE TIMING TOOL KIT BMW (N47/N47S) 柴油引擎正時工具組			



010
HWANG CHERNG BIN
Specialty Tools Inc.

目錄索引
Index

Index

H.C.B-A1477 P122

BMW (S54/M3) CAMSHAFT ALIGNMENT TOOL
BMW (S54/M3) 凸輪軸正時工具

H.C.B-A1340 P122

BMW (M47T2/M47TU/M57T2/M57TU/M67/N45/N45T/N46/N46T/N51/N52/N53/N54/N55/W17)
FLYWHEEL HOLDER
BMW (M47T2/M47TU/M57T2/M57TU/M67/N45/N45T/N46/N46T/N51/N52/N53/N54/N55/W17)
飛輪固定器

H.C.B-A1528 P123

BMW (S65) TIMING TOOL KIT
BMW (S65) 正時工具組

H.C.B-A1597 P123

BMW/ MINI AND PSA GROUP PETROL ENGINE TIMING CHAIN SERVICE TOOL KIT
BMW/ MINI AND PSA GROUP 汽油引擎鏈條正時工具組

H.C.B-A1301 P123

BMW (N62/W17) AIR CONDITIONING COMPRESSION BELT INSTALLER
BMW (N62/W17) 冷氣壓縮機皮帶安裝器

H.C.B-B1301 P124

BMW (N62/W17) AIR CONDITIONING COMPRESSION BELT INSTALLER
BMW (N62/W17) 冷氣壓縮機皮帶安裝器

H.C.B-A1567 P124

BMW (N52K) V-BELT INSTALLER
BMW (N52K) V 型皮帶安裝工具

H.C.B-A1385 P124

BMW (F01/F02/F25/X3) FUEL TANK LID WRENCH
BMW (F01/F02/F25/X3) 油箱蓋拆裝器

H.C.B-A1366 P125

BMW (N47) HIGH PRESSURE PUMP REMOVER
BMW (N47) 高壓泵拆卸組

H.C.B-A1401 P125

BMW FUEL LEVEL SENSOR LOCK RING REMOVER
BMW 汽油幫浦感應器拆卸工具

H.C.B-A1474 P125

MINI COOPER WINDOW WRENCH
MINI COOPER 升降機調整扳手

H.C.B-A2024-8 P126

OIL DRAIN PLUG REMOVER - 8 mm
放油螺塞拆卸器 - 8 mm

H.C.B-A1498 P126

BMW FUEL PUMP REMOVAL/ INSTALLATION TOOL
BMW 汽油幫浦外蓋拆裝工具

H.C.B-A1500 P126

BMW (N20/N26/N46/N55) OIL FILTER PRESSURE CAP
BMW (N20/N26/N46/N55) 機油壓力工具

H.C.B-A1511 P126

MINI W16D DIESEL ENGINE TIMING TOOL
MINI W16D 柴油引擎正時工具組

H.C.B-J2016 P127

BMW/BENZ (W140) ENGINE LIFTING BAR PAT. M481854
BMW/BENZ (W140) 引擎吊架

New H.C.B-A1659 P127

BMW (S85) CLUTCH ALIGNMENT TOOL
BMW (S85) 離合器校正工具

BMW TRANSMISSION REPAIR TOOL
BMW 變速箱修護工具 (P129~133)

H.C.B-A1010 P129

AUTOMATIC TRANSMISSION CLUTCH SPRING COMPRESSOR (IMPROVEMENT)
自動變速箱離合器壓板拆裝工具 (改良型)

H.C.B-A1100 P129

BMW (5HP18/ 5HP19) TRANSMISSION SOCKET (4 TEETH)
BMW (5HP18/ 5HP19) 變速箱專用套筒 (4齒)

H.C.B-A1101 P129

BMW (5HP24/ 5HP30) TRANSMISSION SOCKET (6 TEETH)
BMW (5HP24/ 5HP30) 變速箱專用套筒 (6齒)

H.C.B-A1352 P129

BMW LINE DISCONNECT TOOL
BMW 油管分離器

H.C.B-B1352 P129

BMW (E83/E90) LINE DISCONNECT TOOL
BMW (E83/E90) 油管分離器

H.C.B-A1085 P130

BMW THMR1 TRANSMISSION EXTRACTION / INSTALLATION TOOL KIT
BMW THMR1 變速箱拆裝工具組

H.C.B-A1085-7 P130

BMW THMR1 TRANSMISSION PUMP ALIGNMENT PIN
BMW THMR1 變速箱泵浦定位銷

H.C.B-A1356 P130

BMW OIL COOLER LINE PLIERS
BMW 變速箱油冷卻管拆卸鉗

H.C.B-A1456 P131

BMW 5L 40 TRANSMISSION REMOVAL / INSTALLATION TOOL KIT
BMW 5L 40 變速箱拆裝工具組

H.C.B-A1566 P132

BMW DCT DUAL CLUTCH REMOVER / INSTALLER
BMW DCT 離合器拆裝工具

H.C.B-B1566 P132

BMW DCT CLUTCH COVER ALIGNMENT TOOL
BMW DCT 離合器蓋校正工具

H.C.B-C1566 P132

BMW DCT OUTPUT SHAFT SEAL INSTALLER
BMW DCT 輪軸油封安裝工具

H.C.B-D1566 P132

BMW DCT FRONT TRANSMISSION COVER REMOVAL ALLEN HEAD SOCKETS
BMW DCT 前變速箱蓋拆六角頭套筒

New H.C.B-A1649 P133

BMW (E70/E90/E91/E92) FINAL DRIVE INPUT SHAFT SEAL INSTALLER
BMW (E70/E90/E91/E92) 終傳輸入軸油封安裝器

New H.C.B-A1650 P133

BMW (E70/E90/E91/E92) FINAL DRIVE INPUT SHAFT SEAL SOCKET
BMW (E70/E90/E91/E92) 終傳輸入軸油封螺帽套筒

New H.C.B-A1651 P133

BMW (E70/E90/E91/E92) DRIVESHAFT INNER NUT WRENCH
BMW (E70/E90/E91/E92) 傳動軸內螺帽扳手

New H.C.B-A1652 P133

BMW (E70/E90/E91/E92) DIFFERENTIAL FLANGE NUT WRENCH
BMW (E70/E90/E91/E92) 差速器凸緣盤螺帽扳手

New H.C.B-A1653 P133

BMW EXTENSION BAR
BMW 延長桿



010
HWANG CHERNG BIN
 Speciality Tools Inc.

SINCE 1990

Index

FORD REPAIR TOOL
福特修護工具 (P135~141)

H.C.B-A1031 P135
 FORD LASH ADJUSTER
 FORD 嘉年華全壘打斜式培林間隙搖桿

H.C.B-A1041 P135
 8 PCS BEARING RACE & SEAL DRIVER KIT
 8 PCS 斜式培林安裝器

H.C.B-A1046 P135
 FORD BRAKE PAD EXTRACTOR/INSTALLER
 FORD 煞車襯套拆裝器

H.C.B-A1196 P135
 FORD (ESCAPE, METROSTAR) CRANKSHAFT PULLEY HOLDING TOOL
 FORD (ESCAPE, METROSTAR) 曲軸支撐扳手

H.C.B-A2131 P135
 FORD METROSTAR CALIPER WIND BACK PENTAGON SOCKET
 FORD METROSTAR 煞車分泵五角套筒

H.C.B-A1150 P136
 3 PCS PETROL ENGINE SETTING/ LOCKING KIT (FOR FORD & MAZDA)
 3 PCS FORD, MAZDA 正時工具組

H.C.B-A1107 P136
 FORD METROSTAR TIMING PIN
 FORD METROSTAR 正時插銷

H.C.B-B1107 P136
 FORD/ MAZDA TDC TIMING PINS
 FORD/ MAZDA TDC 正時插銷

H.C.B-A2006-1 P136
 FORD MONDEO SETTING PIN
 FORD MONDEO 正時插銷

H.C.B-A2006 P136
 FORD MONDEO SETTING BAR
 FORD MONDEO 正時工具

H.C.B-A2007 P136
 FORD TELSTAR SETTING BAR (IMPROVEMENT)
 FORD 天王星正時工具 (改良型)

H.C.B-A2208 P137
 FORD FLYWHEEL LOCKING TOOL
 FORD 飛輪固定工具

H.C.B-A1375 P137
 FORD 1.6 16V Ti-VTC TIMING TOOL
 FORD 1.6 16V Ti-VTC 正時工具

H.C.B-B1375 P137
 FORD & MAZDA PETROL ENGINE TIMING TOOL
 FORD & MAZDA 汽油引擎正時工具

H.C.B-A2217 P138
 FORD 1.6 Ti-VCT TIMING TOOL KIT
 FORD 1.6 Ti-VCT 正時工具組

H.C.B-A1449 P138
 FORD V8 CAM TOOLS
 FORD V8 正時工具組

H.C.B-A1433 P138
 FORD DURATEC TIMING PIN
 FORD 正時插銷

H.C.B-A1620 P139
 FORD/MAZDA SERPENTINE BELT TOOL (TDCI)
 FORD/MAZDA 惰輪皮帶調整扳手 (TDCI)

H.C.B-A4013 P139
 FORD 2.0/2.2/2.4 TDDi/TDci DURATORQ ENGINE TIMING TOOLS
 FORD 2.0/2.2/2.4 TDDi/TDci DURATORQ 柴油引擎正時工具組

H.C.B-A1530 P139
 FORD MONDEO MK4 TRAILING ARM BUSH REMOVER/ INSTALLER
 FORD MONDEO MK4 後游臂鐵套拆裝工具組

H.C.B-A1510 P140
 FORD FOCUS & MAZDA 3 REAR TRAILING ARM BUSH REMOVER/ INSTALLER
 FORD FOCUS & MAZDA 3 後游臂鐵套拆裝工具組

H.C.B-A1532 P141
 FORD UPPER A ARM BALL JOINT REMOVAL/ INSTALLATION TOOL
 FORD 雙 A 臂上三角架球接頭拆裝工具

H.C.B-A1563 P141
 FORD DIFF SUPPORT BUSH REMOVAL/ REPLACEMENT TOOL
 FORD 差速器鐵套拆裝工具組

H.C.B-A1583 P141
 FORD FOCUS/ MAZDA 3 FRONT WHEEL HUB/ WHEEL BEARING REMOVAL / INSTALLATION TOOL KIT-82 mm
 FORD FOCUS /MAZDA 3 前輪軸培林拆裝工具組-82 mm

VW REPAIR TOOL
福斯修護工具 (P143~195)

H.C.B-A1045 P143
 VW/ AUDI STRUT SOCKET
 VW/ AUDI 避震器座拆卸套筒

H.C.B-A1053 P143
 VW T4 SUB-FRAME BUSH EXTRACTOR/ INSTALLER
 VW T4 三角架鐵套拆裝工具組

H.C.B-A1055 P143
 VW/ AUDI FRONT AXLE CAMBER ADJUSTER
 VW/ AUDI 前軸外傾角調整工具

H.C.B-A1078 P143
 SPARK PLUG ELECTRIC WIRE REMOVER (VW VR6, PASSAT, BENZ V-CLASS)
 火星塞高壓線拔取器 (VW VR-6, PASSAT, BENZ V-CLASS)

H.C.B-A1080 P144
 VW DIESEL 2400 c.c. CAMSHAFT ALIGNMENT TOOL
 VW 柴油 2400 c.c. 偏心軸正時工具組 (含插銷)

H.C.B-A1424 P144
 VW/ AUDI A6&A8 ADJUSTABLE TIMING TOOL
 VW/ AUDI A6&A8 可調式正時工具

H.C.B-A1105 P144
 VW/ AUDI V6 CAMSHAFT SETTING PLATE
 VW/ AUDI V6 引擎正時工具

New



010
HWANG CHERNG BIN
 Specialty Tools Inc.

目錄索引
Index

Index

H.C.B-A1161	P144	H.C.B-A1218	P149
VW/ AUDI V6 CAMSHAFT SETTING PLATE VW/ AUDI V6 引擎正時工具		VW/ AUDI CV JOINT BOOT CLAMP TOOL VW/ AUDI 防塵套束裝器	
H.C.B-A1205	P145	H.C.B-A1219	P149
VW/ AUDI V8 CAMSHAFT ALIGNMENT TOOL VW/ AUDI V8 正時工具		VW/ AUDI SPARK PLUG ELECTRIC WIRE PULLER VW/ AUDI 火星塞高壓線拔取器	
H.C.B-A1105-4	P145	H.C.B-A1231	P150
VW/ AUDI PETROL V6 CRANK LOCKING PIN VW/ AUDI V6 引擎正時插銷		VW OIL SEAL PULLER (27 mm) (Dr. 1/2") VW 油封拆卸器 (27 mm) (Dr. 1/2")	
H.C.B-A1105-5	P145	H.C.B-B1231	P150
VW/ AUDI V6 CRANK LOCKING PIN VW/ AUDI V6 正時插銷		VW OIL SEAL DRIVER VW 油封安裝器	
H.C.B-A1105-6	P145	H.C.B-A1232	P150
VW/ AUDI (2.0,2.4,2.8,3.0,3.2 FSI) CRANKSHAFT LOCKING PIN VW/ AUDI (2.0,2.4,2.8,3.0,3.2 FSI) 正時插銷		VW OIL SEAL PULLER (32 mm) VW 油封拆卸器 (32 mm)	
H.C.B-A1105-7	P145	H.C.B-B1232	P150
VW/ AUDI (1.4, 1.6 FSI, TSI) CRANKSHAFT LOCKING PIN VW/ AUDI (1.4, 1.6 FSI, TSI) 正時插銷		VW OIL SEAL DRIVER VW 油封安裝器	
H.C.B-A1160	P146	H.C.B-A1233	P150
VW VIBRATION DAMPER COUNTER HOLDER VW 曲軸油封更換器		VW OIL SEAL PULLER (35 mm) VW 油封拆卸器 (35 mm)	
H.C.B-A1108	P146	H.C.B-B1233	P151
VW T4 FRONT AXLE UPPER BALL-JOINT EXTRACTION/INSTALLATION TOOL KIT PAT. I 233868 DE PAT. VW T4 前上三角架球接頭拆裝工具組		VW OIL SEAL DRIVER VW 油封安裝器	
H.C.B-A1162	P146	H.C.B-A1234	P151
VW VR6 CAMSHAFT ALIGNMENT TOOL VW VR6 引擎正時工具組		VW OIL SEAL PULLER (32 mm) LONG BODY VW 油封拆卸器 (32 mm)	
H.C.B-A1164	P147	H.C.B-B1234	P151
VW/ AUDI PETROL 1.4 & 1.6 16V TWIN CAMSHAFT ALIGNMENT TOOL KIT VW/ AUDI 1.4 & 1.6 16V 引擎正時工具組		VW CAMSHAFT SEAL INSTALLER VW 凸輪軸油封安裝器	
H.C.B-A1195	P147	H.C.B-A1230	P151
VW, BMW SOCKET (Dr. 1/2", 12 POINTS, 21 mm) VW, BMW 避震器固定套筒 (Dr. 1/2", 12 角, 21 mm)		VW/ AUDI DRIVING TOOL FOR TENSIONING DEVICE VW/ AUDI 張力皮帶調整器	
H.C.B-B1195	P147	H.C.B-A2110	P151
VW, BMW SOCKET (Dr. 1/2", 12 POINTS, 22 mm) VW, BMW 避震器套筒 (Dr. 1/2", 12 角, 22 mm)		VW/ AUDI EXHAUST SPRING CLAMP REMOVER/INSTALLER VW/ AUDI 排氣管C型夾拆裝器	
H.C.B-A1200	P147	H.C.B-C1235	P152
IDLER PULLEY WRENCH 惰輪調整器		AUDI CAMSHAFT ADJUSTMENT GAUGE KIT (3.0L, V6, PETROL ENGINE) AUDI 正時工具組 (3.0L,V6,汽油引擎)	
H.C.B-A1212	P148	H.C.B-B1235	P152
VW RIBBED BELT TENSIONING WRENCH VW 正時張力皮帶調整扳手		AUDI CAMSHAFT ADJUSTMENT GAUGE KIT (3.0L, V6, PETROL ENGINE) AUDI 正時工具 (3.0L,V6,汽油引擎)	
H.C.B-A1213	P148	H.C.B-A1235	P152
VW/ AUDI CLUTCH RETAINING BAR VW/ AUDI 離合器安裝固定器		AUDI CAMSHAFT ADJUSTMENT GAUGE KIT (2000~2004) (3.0L V6) AUDI 正時工具組 (2000~2004) (3.0L V6)	
H.C.B-A1214	P148	H.C.B-A1054-3	P153
VW/ AUDI CAM CHAIN TENSIONER RETAINER VW/ AUDI 固定凸輪軸調整器		VW T4 CAM BELT PULLEY PULLER VW T4 正時皮帶盤拔取器	
H.C.B-A1215	P148	H.C.B-B1054-3	P153
AUDI V6 FAN CLUTCH FIXING WRENCH AUDI V6 風扇離合器固定扳手		VW T4 CAM BELT PULLEY PULLER ACCESSORIES VW T4 正時皮帶盤拔取器	
H.C.B-B1215	P149	H.C.B-A1512	P153
VW PASSAT / AUDI A4 FAN CLUTCH FIXING WRENCH VW PASSAT / AUDI A4 風扇離合器固定扳手		VW R2/T4/A3 CAM BELT PULLEY PULLER VW R2/T4/A3 凸輪軸拔取器 (改良型)	
H.C.B-A1217	P149	H.C.B-A1295	P154
VW/ AUDI FUEL SENDER WRENCH VW/ AUDI 油箱蓋拆裝器		VW/ AUDI DIESEL INJECTION PUMP WRENCH (13 mm) VW/ AUDI 柴油噴射泵扳手 (13 mm)	



H.C.B-A2069-T30 P154	H.C.B-A1342 P159
Dr. 3/8" x T30 UNIVERSAL JOINT BIT SOCKET Dr. 3/8" x T30 萬用套筒	VW/ AUDI BELT PULLEY HOLDER VW/ AUDI 皮帶盤支撐器
H.C.B-A2069-T40 P154	H.C.B-A1321 P159
Dr. 3/8" x T40 UNIVERSAL JOINT BIT SOCKET Dr. 3/8" x T40 萬用套筒	VW HARMONIC DAMPER REMOVER VW 正時皮帶盤拆卸器
H.C.B-A2069-T45 P154	H.C.B-A1322 P159
Dr. 3/8" x T45 UNIVERSAL JOINT BIT SOCKET Dr. 3/8" x T45 萬用套筒	VW/ AUDI CRANKSHAFT PULLEY REMOVER VW/ AUDI 正時皮帶盤拆卸器
H.C.B-A2069-T50 P154	H.C.B-A1323 P160
Dr. 3/8" x T50 UNIVERSAL JOINT BIT SOCKET Dr. 3/8" x T50 萬用套筒	VW/ AUDI VIBRATION DAMPER LOCKING TOOL VW/ AUDI 正時皮帶盤支撐器
New H.C.B-A1662 P154	H.C.B-A1324 P160
VAG (1.8/2.0 TSI) CAMSHAFT ROTATING ALIGNMENT TOOL VAG (1.8/2.0 TSI) 凸輪軸轉動正時工具	VW/ AUDI VIBRATION DAMPER LOCKING TOOL VW/ AUDI 正時皮帶盤支撐器
H.C.B-A2069 P155	H.C.B-A1325 P160
7 PCS Dr. 3/8" TX-STAR UNIVERSAL JOINT BIT SOCKET KIT (T20, T25, T27, T30, T40, T45, T50) 7 PCS Dr. 3/8" 萬用套筒組 (T20, T25, T27, T30, T40, T45, T50)	VW/ AUDI BELT TENSION ADJUSTER VW/ AUDI 惰輪調整器
H.C.B-B2069 P155	H.C.B-A1343 P160
8 PCS Dr. 1/2" TX-STAR UNIVERSAL JOINT BIT SOCKET KIT (T30, T40, T45, T50, T55, T60, T70, T80) 8 PCS Dr. 1/2" 萬用套筒組 (T30, T40, T45, T50, T55, T60, T70, T80)	VW/ AUDI DIFFERENTIAL FILTER SPANNER VW/ AUDI 差速器濾芯扳手
H.C.B-A2087 P155	H.C.B-A1348 P161
VW T4 PROPELLER SHAFT SPECIAL SOCKET (M8/M10/M12/M14) VW T4 傳動軸特殊長套筒 (M8/M10/M12/M14)	VW/ AUDI OIL FILTER WRENCH (Dr. 1/2", H= 22 mm, D= 42 mm) VW/ AUDI 機油芯扳手 (Dr. 1/2", H=22 mm, D=42 mm)
H.C.B-A1220 P156	H.C.B-A2137 P161
VW/ AUDI BELT TENSION PIN WRENCH VW/ AUDI 皮帶張力調整扳手	4 PCS VW/ AUDI IGNITION COIL PULLER VW/ AUDI 直接點火線圈拔取器組 (4 PCS)
H.C.B-B1220 P156	H.C.B-A2201 P161
VW/ AUDI TIMING BELT TENSION ADJUSTER (240 mm) VW/ AUDI 惰輪正時皮帶張力調整扳手 (240 mm)	VW/ AUDI (A4/A6/A8/A11) GAS / DIESEL ENGINE TIMING TOOL KIT VW/ AUDI (A4/A6/A8/A11) 汽/ 柴油引擎正時工具組
H.C.B-C1220 P156	H.C.B-A2211 P161
VW/ AUDI BELT TENSIONER ADJUSTMENT WRENCH VW/ AUDI 惰輪正時皮帶盤調整扳手	VW/ AUDI AIRBAG REMOVAL TOOL KIT (12 PCS) VW/ AUDI 安全氣囊拆除工具組 (12 PCS)
H.C.B-A1276 P157	H.C.B-A2207 P162
AUDI CAMSHAFT ADJUSTING SOCKET (Dr. 3/8") AUDI 凸輪軸調整套筒 (Dr. 3/8")	VW/ AUDI DIESEL TDI PD ENGINE TIMING TOOL KIT VW/ AUDI 柴油 TDI PD 引擎正時工具
H.C.B-A2108 P157	H.C.B-A1364 P162
VW/ AUDI WATER PUMP PULLEY LOCKING WRENCH VW/ AUDI 水幫浦皮帶盤支撐扳手	VW/ AUDI REAR AXLE BUSHING TOOL VW/ AUDI 鐵套拆卸器
H.C.B-A2109 P157	H.C.B-C1357 P163
VW/ AUDI WATER PUMP PULLEY LOCKING WRENCH VW/ AUDI 水幫浦皮帶盤支撐扳手	VW/ AUDI (TDI)/ BMW N47/ N57 DIESEL INJECTOR REMOVER VW, AUDI (TDI)/ BMW N47/ N57 柴油噴油嘴拆卸器
H.C.B-A2154 & A2090 P158	H.C.B-B1357 P164
BENZ (M271), VW/ AUDI V-BELT PULLEY REMOVER/INSTALLER (Dr. 1/2", M10) BENZ (M271), VW/ AUDI 發電機皮帶盤拆裝器 (Dr. 1/2", M10)	VW/ AUDI (TDI), BMW N47/ N57 DIESEL INJECTOR REMOVER VW/ AUDI (TDI), BMW N47/ N57 柴油噴油嘴拆卸器
H.C.B-A2181 P158	H.C.B-A1357 P164
VW/ AUDI IMPACT SOCKET (Dr. 3/4", M18, 105 mm) VW/ AUDI 後仰角傳動軸套筒 (Dr. 3/4", M18, 105 mm)	VW/ AUDI (TDI) DIESEL INJECTOR REMOVER VW/ AUDI (TDI) 柴油噴油嘴拆卸器
H.C.B-B2181 P158	H.C.B-A1368 P165
VW/ AUDI IMPACT SOCKET (Dr. 1/2", M18, 78 mm) VW/ AUDI 後仰角傳動軸套筒 (Dr. 1/2", M18, 78 mm)	VW POLO BUSH REMOVER/ INSTALLER VW POLO 鐵套拆裝工具組
H.C.B-A1307 P159	H.C.B-A1372 P165
VW/ AUDI SPECIAL WRENCH (V6, TDI, TURBO) VW/ AUDI 特殊扳手 (V6, TDI, TURBO)	VW DIESEL INJECTOR PUMP TEST GAUGE KITS VW 柴油噴油嘴幫浦測試錶組
	H.C.B-A1373 P165
	VW/ AUDI FSI 2.0 L / TURBO TIMING TOOL VW/ AUDI FSI 2.0 L / TURBO 正時工具



010

HWANG CHERNG BIN
Specialty Tools Inc.

目錄索引
Index

Index

H.C.B-A1386 P165 AUDI ENGINE OIL LEVEL GAUGE AUDI 機油尺	H.C.B-A1429 P173 VW FUEL TANK WRENCH VW 汽油浮筒拆裝器
H.C.B-B2224 P166 VW CAMSHAFT DRIVE BELT PULLER VW 凸輪軸皮帶盤拆卸器	H.C.B-A1642 P173 New VW/ AUDI CAMSHAFT TIMING CHAIN TOOL KIT (4.2L) VW/ AUDI 凸輪軸正時鍊條工具組 (4.2L)
H.C.B-A2070 P166 VW/ AUDI TRANSMISSION/ GEARBOX SOCKET (Dr. 1/2", M16) VW/ AUDI 變速箱/ 齒輪箱套筒 (Dr. 1/2", M16)	H.C.B-A1430 P174 AUDI FIXING GAUGE AUDI 固定座
H.C.B-B2070 P166 VW/ AUDI TRANSMISSION/ GEARBOX SOCKET (Dr. 1/2", M18) VW/ AUDI 變速箱/ 齒輪箱套筒 (Dr. 1/2", M18)	H.C.B-A1431 P174 VW/ AUDI CAMSHAFT BAR VW/ AUDI 固定條
H.C.B-C2070 P166 VW/ AUDI TRANSMISSION/GEARBOX SOCKET (Dr. 1/2", M16) VW/ AUDI 變速箱/ 齒輪箱套筒 (Dr. 1/2", M16)	H.C.B-A1471 P174 VW/ AUDI ENGINE TIMING TOOL KIT (TFSI) VW/ AUDI 正時工具組 (TFSI)
H.C.B-A2085 P167 VW T4 TRANSPORTERS MULTI-SPLINE SOCKET (Dr. 1/2", M14) VW T4 輸送機上球頭拆卸套筒 (Dr. 1/2", M14)	H.C.B-A2232 P174 SHOCK ABSORBER RAM DISMANTLE SOCKET KIT 避震器油壓缸拆裝套筒組
H.C.B-B1475 P167 VW SPECIAL SOCKET (Dr. 3/8" x 17 mm x 78 mm L) VW 柴油噴油嘴高壓管特殊套筒 (Dr. 3/8" x 17 mm x 78 mm 長)	H.C.B-A1470 P175 VW/ AUDI CAMSHAFT ALIGNMENT TOOL (4.2) VW/ AUDI 凸輪軸正時工具 (4.2)
H.C.B-B2155-24 P167 VW SPECIAL SOCKET (12 POINT, SW 24 mm) VW 特殊套筒 (12 角, SW 24 mm)	H.C.B-A1473 P175 VW/ AUDI CAMSHAFT CENTRAL VALVE SOCKET VW/ AUDI 凸輪軸調節閥套筒
H.C.B-E1413 P168 VW 1.2 TSI TIMING TOOL KIT VW 1.2 TSI 正時工具組	H.C.B-B1473 P175 VW/ AUDI CAMSHAFT CENTRAL VALVE SOCKET (Dr. 3/8") VW/ AUDI 凸輪軸調節閥套筒 (Dr. 3/8")
H.C.B-F1413 P168 VAG TFSI/FSI ENGINE TIMING TOOL KIT VAG TFSI/FSI 引擎正時工具組	H.C.B-C1473 P175 VW/ AUDI CAMSHAFT CENTRAL VALVE SOCKET (Dr. 3/8") VW/ AUDI 凸輪軸調節閥套筒 (Dr. 3/8")
H.C.B-G1413 P168 VAG 1.2 TFSI/TSI PETROL ENGINES CHAIN ENGINE LOCKING TIMING TOOL KIT VAG 1.2 TFSI/TSI 汽油引擎鏈條固定正時工具組	H.C.B-D1473 P175 New VW/ AUDI CAMSHAFT CONTROL VALVE 1.8/2.0 TFSI SOCKET VW/ AUDI 凸輪軸調節閥 1.8/2.0 TFSI 套筒
H.C.B-D1413 P169 VW/ AUDI GROUR FSI (VAG) VALVE TIMING TOOL KIT VW/ AUDI GROUR FSI (VAG) 閥門正時工具組	H.C.B-A1479 P176 VW DRIVE FLANGE OIL SEAL REMOVER/INSTALLER VW 傳動軸拆裝工具
H.C.B-C1413 P170 AUDI A4/A6/A8 (2.4/3.2 FSI) CHAIN ENGINES TIMING TOOL KIT AUDI A4/A6/A8 (2.4/3.2 FSI) 鏈條正時工具組	H.C.B-A1486 P176 VW OIL FILTER WRENCH (Dr. 1/2", 15 POINTS, 92 mm) VW 機油芯扳手 (Dr. 1/2", 15 角, 92 mm)
H.C.B-B1413 P170 VW/ AUDI PETROL ENGINE TIMING TOOL KIT (WITH GAUGE) (1.4, 1.6 FSI) VW/ AUDI 正時工具組 (附錶) (1.4, 1.6 FSI)	H.C.B-A1489 P176 VW (TIGUAN/GOLF) SUB-FRAME BUSH EXTRACTOR/INSTALLER VW (TIGUAN/GOLF) 三角架鐵套拆裝工具
H.C.B-A1413 P171 VW/ AUDI PETROL ENGINE TIMING TOOL KIT (1.4, 1.6 FSI) VW/ AUDI 正時工具組 (1.4, 1.6 FSI)	H.C.B-A2256 P177 VAG/ FORD (1.2D, 1.4D, 1.6D, 1.9D, 2.0D TDI PD/CR) DIESEL ENGINE TIMING TOOL KIT VAG/ FORD (1.2D, 1.4D, 1.6D, 1.9D, 2.0D TDI PD/CR) 柴油正時工具組
H.C.B-A1414 P171 VW/ AUDI VALVE SPRING COMPRESSOR VW/ AUDI 汽門彈簧拆卸工具	H.C.B-B2256 P177 VAG FRONT END SUPPORT GUIDE KIT VAG 前端面板支撐架零件組
H.C.B-A1565 P171 WATER PUMP REMOVAL TOOL KIT - VW T5 & TOUAREG 2.5D 水泵浦拆卸器組 - VW T5 & TOUAREG 2.5D	H.C.B-A1501 P178 VW/ AUDI FUEL PUMP WRENCH VW/ AUDI 汽油幫浦拆裝器
H.C.B-B1419 P172 VW TRANSPORTER T5 AND TOUAREG DIESEL TIMING TOOL KIT (2.5 /4.9D /TDI PD) VW TRANSPORTER T5 AND TOUAREG 柴油引擎正時工具組 (2.5 /4.9D /TDI PD)	H.C.B-A1505 P178 AUDI/ GOLF/ OCTAVIA/ LEON CAMSHAFT LOCK TOOL AUDI/ GOLF/ OCTAVIA/ LEON 凸輪軸固定工具
H.C.B-A1425 P173 VW/ AUDI CRANKSHAFT TURNING SOCKET VW/ AUDI 曲軸旋轉套筒	H.C.B-A1506 P178 VW COUNTER HOLDER VW 曲軸支撐扳手



010
HWANG CHERNG BIN
 Speciality Tools Inc.

Index

New H.C.B-D1506 P178 VAG 1.8/2.0 TSI/TFSI (EA888) ENGINE TIMING TOOL KIT VAG 1.8/2.0 TSI/TFSI (EA888) 引擎正時工具組	H.C.B-A2260 P184 SPLINE IMPACT BIT SOCKET KIT (Dr. 1/2") (4 PCS) 12 角星型氣動套筒組 (Dr. 1/2") (4 PCS)
H.C.B-B1506 P179 VW/ AUDI 2.0L TURBO ENGINE TIMING TOOL KIT VW/ AUDI 2.0L 渦輪引擎正時工具組	H.C.B-A2267 P185 VW/ AUDI FLEXIBLE MULTI-TOOTH SOCKET(Dr. 3/8" XNZ, M10 x 130 mm (L)) VW/ AUDI 套筒 (Dr. 3/8" XNZ, M10 x 130 mm(L))
H.C.B-A1551 P179 VW CAMSHAFT COUNTER HOLDER VW 凸輪軸支撐扳手	H.C.B-A2268 P185 VAG 1.2 L (3CYL.) - 6V/12V PETROL ENGINE TOOL KIT VAG 1.2 公升 (3 汽缸) - 6V/12V 汽油引擎工具組
H.C.B-B1551 P179 VW CAMSHAFT SPROCKET PULLER VW 凸輪軸齒輪拔取器	H.C.B-A1604 P185 VAG 21t 4CYL OIL SUMP PLUG REMOVAL TOOL (Dr. 1/4") VAG 21t 4 汽缸油底殼拆卸工具 (Dr. 1/4")
H.C.B-C1551 P180 VW/ AUDI VAG DIESEL ENGINE CAMSHAFT SPROCKET TOOL VW/ AUDI VAG 柴油引擎凸輪軸鏈條拆裝工具組	H.C.B-I2016 P186 VW T5 ENGINE SUPPORT BRIDGE VW T5 引擎平衡桿
H.C.B-A1507 P180 VW PULLEY PULLER VW 皮帶拉拔器	H.C.B-A1584 P186 VW/ AUDI CAMSHAFT DIESEL ALIGNMENT TOOL VW/ AUDI 凸輪軸柴油正時工具組
H.C.B-A1508 P180 VW CIGARETTE LIGHTER RELEASE TOOL VW 點菸工具	H.C.B-A1547 P186 VW/ AUDI DRIVE SPROCKET ADJUSTMENT TOOL VW/ AUDI 驅動齒輪調整工具
H.C.B-A1509 P181 VW TRANSMISSION SUPPORT DEVICE VW 變速箱拆裝支撐架	H.C.B-A1548 P187 VW/ AUDI DRIVE SPROCKET ADJUSTMENT FIXTURE TOOL VW/ AUDI 驅動齒輪調整固定工具
H.C.B-A1513 P181 VAG TDI DIESEL ENGINE CYLINDER COMPRESSION PRESSURE HOSE VAG TDI 柴油引擎汽缸壓縮壓力油管	H.C.B-A1549 P187 VW/ AUDI FLYWHEEL LOCKING TOOL VW/ AUDI 飛輪固定器
New H.C.B-C1514 P182 VW CRAFTER CRANKSHAFT SEAL INSTALLER (DIESEL) VW CRAFTER 曲軸油封安裝工具 (柴油)	H.C.B-B1447 P187 VW GTI FRONT SUSPENSION SHOCK ABSORBER SPRING COMPRESSOR VW GTI 彈簧避震器拆裝工具
H.C.B-A1514 P182 VW/ AUDI CRANKSHAFT REAR SEAL INSTALLER (DIESEL) VW/ AUDI 曲軸後油封安裝工具 (柴油)	H.C.B-A1552 P188 VW/ AUDI 7-SPEED DSG CLUTCH REMOVAL/INSTALLATION TOOL KIT VW/ AUDI 7速DSG 變速箱離合器拆裝器
H.C.B-B1514 P182 VW/ AUDI CRANKSHAFT REAR SEAL INSTALLER VW/ AUDI 曲軸後油封安裝工具	H.C.B-B1552 P188 VW/ AUDI 7-SPEED DSG TRANSMISSION SPACER VW/ AUDI 7速DSG 變速箱離合器墊塊
H.C.B-A1519 P183 VW T5 CRANKSHAFT TURNING TOOL (Dr. 1/2") VW T5 曲軸旋轉工具 (Dr. 1/2")	H.C.B-C1552 P188 VW/ AUDI 7-SPEED DSG GEARBOX MECHATRONIC ASSEMBLY LEVER VW/ AUDI 7速DSG 變速箱離合器閥體拆裝器
H.C.B-A1515 P183 VW T5 WHEEL HUB/WHEEL BEARING TOOL KIT VW T5 輪軸/ 培林拆裝工具組	H.C.B-A1544 P189 VW FRONT SUSPENSION SLIENT BLOCK EXTRACTION/ INSTALLATION TOOL KIT (W/ HYDRAULIC CYLINDER) VW 前工字標鐵套拆裝工具組 (油壓式)
H.C.B-A1522 P183 VW/ AUDI (2.4/3.0/3.2/4.2/5.0/5.2) CAMSHAFT TIMING TOOL KIT VW/ AUDI (2.4/3.0/3.2/4.2/5.0/5.2) 凸輪軸正時工具組	H.C.B-B1544 P189 VW FRONT SUSPENSION SILENT BLOCK EXTRACTION/ INSTALLATION TOOL KIT (MANUAL) VW 前工字標鐵套拆裝工具組 (手動)
H.C.B-A1525 P184 VAG (2.7D, 3.0D TDI V6, 4.0D, 4.2D TDI V8) DIESEL ENGINE SETTING/LOCKING & HP PUMP REMOVAL TOOL KIT VAG (2.7D, 3.0D TDI V6, 4.0D, 4.2D TDI V8) 柴油引擎正時工具 & 馬力泵浦拆卸工具組	H.C.B-A1536 P190 VW (TOUAREG) / AUDI (Q7) / PORSCHE (CAYENNE) LOWER TRAILING ARM BUSH REMOVER/INSTALLER VW (TOUAREG) / AUDI (Q7) / PORSCHE (CAYENNE) 前三角架鐵套拆裝工具組



010
HWANG CHERNG BIN
Specialty Tools Inc.

目錄索引
Index

Index

H.C.B-E1129 P190
VW GOLF/ AUDI A3 REAR TRAILING ARM BUSHING REMOVER/INSTALLER (W/ HYDRAULIC CYLINDER)
VW GOLF/ AUDI A3 後游臂鐵套拆裝工具 (油壓式)

H.C.B-A1575 P191
VW T5 FRONT SUB-FRAME BUSH REMOVAL / INSTALLATION TOOL KIT PAT.M504750
VW T5 前三角架鐵套拆裝工具組

H.C.B-A1578 P191
VW CRAFTER 2.5 TDI CRANKSHAFT PULLEY HOLDER
VW CRAFTER 2.5 TDI 曲軸皮帶盤支撐扳手

H.C.B-A1576 P192
VAG/PORSCHE CAMSHAFT CYLINDER HEAD TIMING TOOL KIT
VAG/PORSCHE 凸輪軸汽缸蓋正時工具組

H.C.B-A1580 P192
VAG DIESEL ENGINE TIMING TOOL KIT
VAG 柴油引擎正時工具組

H.C.B-A1591 P192
VW/ AUDI FUEL TANK SENDER WRENCH (A6/A8)
VW/ AUDI 油箱蓋拆裝器 (A6/A8)

New **H.C.B-B1594** P193
VAG 1.0, 3 CYLINDER ENGINE TIMING TOOL KIT
VAG 1.0, 3 汽缸引擎正時工具組

H.C.B-A1595 P193
AUDI A8 CAMSHAFT LOCATING TOOL KIT
AUDI A8 凸輪軸正時工具組

New **H.C.B-C2276** P193
VAG 1.6/2.0 TDI CRANKSHAFT TIMING TOOL KIT
VAG 1.6/2.0 TDI 曲軸正時工具組

New **H.C.B-B2276** P194
VAG 1.6/2.0 TDI CRANKSHAFT LOCK TOOL KIT
VAG 1.6/2.0 TDI 曲軸固定工具組

H.C.B-A2276 P194
VAG 1.2, 1.6 & 2.0 TDI ENGINE TIMING TOOL KIT
VAG 1.2, 1.6 & 2.0 TDI 引擎正時工具組

H.C.B-A1607 P194
VW/ AUDI 4 CYLINDER TDI TIMING TOOL KIT
VW/ AUDI 4 汽缸 TDI 正時工具組

New **H.C.B-A1631** P195
VW WEDGE KIT
VW 門板翹棒工具組

New **H.C.B-A1632** P195
VAG 1.4 TFSI CAMSHAFT TIMING TOOL KIT
VAG 1.4 TFSI 凸輪軸正時工具組

New **H.C.B-A1633** P195
VAG 1.8 & 2.0 TFSI CHAIN TENSIONER LEVER
VAG 1.8 & 2.0 TFSI 正時鏈條張緊器

SUBARU REPAIR TOOL
SUBARU 修護工具 (P197~203)

H.C.B-A1079-1 P197
SUBARU IMPREZA CRANKSHAFT PULLEY REMOVER/ INSTALLER (6 POINTS, 60 mm)
SUBARU IMPREZA 正時皮帶盤拆裝工具 (6 角, 60 mm)

H.C.B-A1079-2 P197
SUBARU IMPREZA CRANKSHAFT PULLEY REMOVER/ INSTALLER (12 POINTS)
SUBARU IMPREZA 正時皮帶盤拆裝工具 (星型)

H.C.B-A1079-3 P197
SUBARU IMPREZA CRANKSHAFT PULLEY REMOVER/ INSTALLER (12 POINTS)
SUBARU IMPREZA 正時皮帶盤拆裝工具 (星型)

H.C.B-A1093 P197
SUBARU IMPREZA CRANKSHAFT PULLEY REMOVER/ INSTALLER
SUBARU IMPREZA 正時皮帶盤拆裝工具

H.C.B-B1093 P198
SUBARU CRANK PULLEY WRENCH
SUBARU 曲軸皮帶支撐扳手

H.C.B-A1134 P198
SUBARU ESTRATTO, TUTTO, DOMINGO OIL FILTER WRENCH
SUBARU 金福相, 金美滿, 多猛哥機油芯扳手

H.C.B-A1149 P198
SUBARU LEGACY 2500 c.c. CRANKSHAFT PULLEY HOLDING TOOL
SUBARU 力獅 2500 c.c. 曲軸皮帶支撐扳手

H.C.B-A1151 P199
SUBARU IMPREZA 1800 c.c. CRANKSHAFT PULLEY HOLDING TOOL
SUBARU IMPREZA 1800 c.c. 曲軸皮帶盤支撐扳手

H.C.B-A1152 P199
SUBARU LAGACY 2200 c.c. CAMSHAFT PULLEY HOLDING TOOL
SUBARU 力獅 2200 c.c. 凸輪軸皮帶盤支撐扳手

H.C.B-A1197 P199
SUBARU AVCS INTAKE CAM SPROCKET TOOL
SUBARU 凸輪軸支撐扳手

H.C.B-B1197 P200
SUBARU FORESTER 2500 c.c. CAMSHAFT PULLEY HOLDER
SUBARU FORESTER 2500 c.c. 支撐扳手

H.C.B-A1202 P200
SUBARU IMPREZA CAMSHAFT PULLEY REMOVER / INSTALLER
SUBARU IMPREZA 凸輪軸皮帶盤拆裝工具

H.C.B-A1285 P200
SUBARU IMPREZA REAR AXLE BUSH EXTRACTOR/ INSTALLER
SUBARU IMPREZA 後羊角鐵套拆裝組

H.C.B-A1315 P201
SUBARU 2500 c.c. CAMSHAFT ALIGNMENT TOOL
SUBARU 2500 c.c. 凸輪軸正時工具

New **H.C.B-B1315** P201
SUBARU (2.0L/2.5L) CAMSHAFT ALIGNMENT TOOL
SUBARU (2.0L/2.5L) 凸輪軸正時工具

H.C.B-A1400 P201
SUBARU CAMSHAFT SPROCKET HOLDER
SUBARU 凸輪軸鏈輪扳手



010
HWANG CHERNG BIN
 Speciality Tools Inc.

SINCE 1990

Index

H.C.B-A1459 P201

SUBARU EJ25 CAMSHAFT PULLEY HOLDER
 SUBARU EJ25 凸輪軸支撐扳手

H.C.B-A1428 P202

SUBARU PUMP TANK LID WRENCH
 SUBARU 汽油幫浦油箱蓋拆裝器

H.C.B-A1450 P202

SUBARU CAMLOCK TOOL
 SUBARU 凸輪軸固定工具



H.C.B-B1450 P202

SUBARU CAMLOCK TOOL
 SUBARU 凸輪軸固定工具

H.C.B-A1463 P203

SUBARU CRANK SOCKET (Dr. 1/2")
 SUBARU 曲軸套筒 (Dr. 1/2")

H.C.B-A2284 P203

IMPACT BIT SOCKET TORX PLUS (Dr. 1/2", 78 mm (L), 50 IP)
 氣動套筒 TORX PLUS (Dr. 1/2", 78 mm (L), 50 IP)

H.C.B-B2284 P203

IMPACT BIT SOCKET TORX PLUS (Dr. 1/2", 78 mm (L), 55 IP)
 氣動套筒 TORX PLUS (Dr. 1/2", 78 mm (L), 55 IP)

SAAB REPAIR TOOL
SAAB 修護工具 (P205~206)

H.C.B-A1062 P205

SAAB FUEL TANK LID REMOVER / INSTALLER
 SAAB 油箱蓋拆裝工具 (更換汽油幫浦)

H.C.B-A1063 P205

SAAB SOCKET TOOL FOR PRESSURE SWITCH
 SAAB ABS 壓力開關專用套筒

H.C.B-A1312 P205

SAAB CRANKSHAFT REAR OIL SEAL INSTALLER
 SAAB 曲軸後油封安裝工具組

H.C.B-A1346 P206

SAAB SUSPENSION BUSH EXTRACTOR / INSTALLER (SAAB 95)
 SAAB 工字樑鐵套拆裝工具組 (SAAB 95)

H.C.B-A1367 P206

SAAB (900) CLUTCH PRESSURE PLATE REMOVAL / INSTALLATION TOOL KIT
 SAAB (900) 手排離合器壓板拆裝工具組

LAND ROVER TOOL
路虎 正時工具 (P208~214)

H.C.B-A1484 P208

JAGUAR / LAND ROVER (V8) 5.0L PETROL TIMING TOOLS
 JAGUAR / LAND ROVER (V8) 5.0L 正時工具

H.C.B-A1485 P208

JAGUAR / LAND ROVER (V8) 4.2/ 4.4L PETROL TIMING TOOLS
 JAGUAR / LAND ROVER (V8) 4.2/ 4.4L 正時工具組

H.C.B-A1405 P208

JAGUAR / LAND ROVER TIMING TOOL KIT
 JAGUAR / LAND ROVER 正時工具組

H.C.B-B1405 P209

JAGUAR / LAND ROVER TIMING TOOL KIT
 JAGUAR / LAND ROVER 正時工具組



H.C.B-C1405 P209

JAGUAR / LAND ROVER CRANKSHAFT PULLEY REMOVAL / INSTALLATION TOOL KIT
 JAGUAR / LAND ROVER 曲軸皮帶盤拆裝工具組

H.C.B-A2219 P209

JAGUAR / LAND ROVER ENGINE TIMING TOOL KIT
 JAGUAR / LAND ROVER 引擎正時工具組

H.C.B-L1001 P210

JAGUAR FLANGE HOLDING TOOL
 JAGUAR 支撐扳手

H.C.B-L1002 P210

LAND ROVER VISCOUS FAN NUT WRENCH
 LAND ROVER 螺帽風扇扳手

H.C.B-L1003 P210

LAND ROVER HIGH / LOW SELECTION LOCKING TOOL
 LAND ROVER 高低壓固定選擇器

H.C.B-L1004 P211

FORD DURATORQ LOCKING TOOL
 FORD DURATORQ 固定工具

H.C.B-L1005 P211

JAGUAR / LAND ROVER CRANKSHAFT REAR SEAL REMOVER / REPLACER
 JAGUAR / LAND ROVER 更換曲軸後油封工具

H.C.B-L1006 P211

JAGUAR / LAND ROVER ALIGNER
 JAGUAR / LAND ROVER 校準工具

H.C.B-L1007 P212

FORD INSTALLER
 FORD 安裝工具

H.C.B-L1008 P212

LAND ROVER FUEL TANK LOCK RING WRENCH
 LAND ROVER 汽油浮筒拆裝器

H.C.B-L1009 P212

LAND ROVER FORCING SCREW AND BOLTS
 LAND ROVER 加壓螺絲與螺母

H.C.B-L1010 P212

LAND ROVER CRANKSHAFT LOCKING TOOL
 LAND ROVER 曲軸固定工具

H.C.B-L1011 P213

JAGUAR / LAND ROVER CLUTCH ALIGNMENT TOOL
 JAGUAR / LAND ROVER 離合器校正工具



010

HWANG CHERNG BIN
Specialty Tools Inc.

目錄索引
Index

Index

H.C.B-L1012 P213
JAGUAR / LAND ROVER ALIGNER
JAGUAR / LAND ROVER 校正工具

H.C.B-L1013 P213
LAND ROVER DAMPER REMOVER
LAND ROVER 阻尼拆卸器

H.C.B-L1014 P214
FORD REMOVER / INSTALLER
FORD 拆裝工具

New **H.C.B-A1645** P214
LAND ROVER / JAGUAR OIL FILTER WRENCH (Dr. 1/2", 90 mm x 15 FLUTES)
LAND ROVER / JAGUAR 機油芯扳手 (Dr. 1/2", 90 mm x 15 角)

New **H.C.B-G1168** P214
LAND ROVER V8 (4000 c.c.) BALL JOINT REMOVAL / INSTALLATION TOOL KIT
LAND ROVER V8 (4000 c.c.) 球接頭拆裝工具組

PORSCHE TOOL
保時捷專區 (P216~221)

H.C.B-C1207 P216
PORSCHE CAMSHAFT ALIGNMENT TOOL KIT
保時捷正時工具組

H.C.B-B1207 P216
PORSCHE CAMSHAFT ALIGNMENT TOOL KIT
保時捷正時工具組

H.C.B-A1207 P216
PORSCHE CAMSHAFT ALIGNMENT TOOL KIT
保時捷正時工具組

H.C.B-D1207 P217
PORSCHE TIMING TOOL KIT (FOR 997)
保時捷正時工具組 (997 專用)

H.C.B-F1207 P217
PORSCHE CAYENNE CAMSHAFT ALIGNMENT TOOL KIT (TURBO / TURBOS)
保時捷凱宴凸輪軸正時工具組 (渦輪/ 雙渦輪)

H.C.B-G1207 P217
PORSCHE CAYENNE CAMSHAFT ALIGNMENT TOOL KIT
保時捷凱宴凸輪軸正時工具組

H.C.B-H1207 P218
PORSCHE PANAMERA AUXILIARY CHAIN TENSIONER
保時捷 PANAMERA 氣壓鏈條張緊器

H.C.B-I1207 P218
PORSCHE TIMING PIN
保時捷插銷

H.C.B-J1207 P218
PORSCHE AUXILIARY CHAIN TENSIONERS (911/993/964/911 GT3 (996))
保時捷鏈條張緊器 (911/993/964/911 GT3 (996))

H.C.B-K1207 P218
PORSCHE CAM TIMING TOOL (911/993)
保時捷正時工具組 (911/993)

H.C.B-L1207 P218
PORSCHE CAM SPROCKET HOLDING WRENCH (911)
保時捷凸輪軸支撐扳手 (911)

H.C.B-M1207 P219
PORSCHE DIAL IND. HOLDER KIT (911)
保時捷錶組 (911)

H.C.B-A2103-0516 P219
PORSCHE SOCKET (Spline (XZN) Dr. 1/2", M16 x 55 mm)
保時捷套筒 (Spline (XZN) Dr. 1/2", M16 x 55 mm)

New **H.C.B-A1629** P219
PORSCHE BRAKE CALIPER PAD SCREW SOCKET (Dr. 1/2", 10 POINTS)
保時捷利車卡鉗螺絲套筒 (Dr. 1/2", 10 角)

H.C.B-A1585 P220
PORSCHE CAYENNE/AUDI Q7/VW TOUAREG HUB PULLER (EXTRA LARGER)
保時捷凱宴/AUDI Q7/VW TOUAREG 輪軸拔卸器 (加大型)

New **H.C.B-B1585** P220
PORSCHE CAYENNE /AUDI Q7/VW TOUAREG HUB PULLER (EXTRA LARGER) (P.C.D: 109 ~160 mm) (W/HYDRAULIC CYLINDER)
保時捷凱宴 /AUDI Q7/VW TOUAREG 輪軸拔卸器 (加大型) (P.C.D: 109~160 mm) (油壓)

New **H.C.B-A1621** P221
PORSCHE TIMING TOOL (987/981/997/911)
保時捷 正時工具 (987/981/997/911)

New **H.C.B-D2288** P221
PORSCHE WHEEL LOCK SCREW SOCKET KIT (20 PCS)
保時捷防盜螺絲套筒組 (20 PCS)

HONDA REPAIR TOOL
HONDA 修護工具 (P223~232)

H.C.B-A1052 P223
DOUBLE WISHBONE ALIGNMENT TOOLS (IMPROVEMENT) PAT. 196708
雙A 臂羊角校正器 (改良型)

H.C.B-A1052-9 P223
ACCESSORY USE ON MITSUBISHI GALANT ONLY
三菱GALANT 專用配件

H.C.B-A2112 P223
12 PCS TX-PLUS BITS KIT
12 PCS 5 角星型中空套筒組

H.C.B-A2030 P224
HONDA, ACURA & CR-V HARMONIC DAMPER PULLEY HOLDER
HONDA, ACURA & CR-V 正時皮帶盤支撐扳手

H.C.B-B2030 P224
HONDA, ACURA & CR-V HARMONIC DAMPER PULLEY HOLDER
HONDA, ACURA & CR-V 正時皮帶盤支撐扳手

H.C.B-C2030 P225
HONDA CRANK PULLEY HOLD WRENCH (Dr. 1/2")
HONDA 曲軸支撐扳手 (Dr. 1/2")



010
HWANG CHERNG BIN
 Speciality Tools Inc.

SINCE 1990

Index

H.C.B-D2030 P225
 HONDA BELT PULLEY HOLDER
 HONDA 皮帶盤固定器

H.C.B-A2180 P225
 HONDA CR-V REAR TRAILING ARMS NUT SOCKET (Dr. 1/2", 10 POINTS, 20 mm)
 HONDA CR-V 後游臂螺帽套筒 (Dr. 1/2", 10 角, 20 mm)

H.C.B-A7002 P226
 HONDA LOWER CONTROL ARM BUSH REMOVER / INSTALLER (HYDRAULIC DRIVE) PAT. M 277669
 USA PAT. PEN
 HONDA 三角架鐵套拆裝工具組 (油壓)

H.C.B-A7001 P227
 HONDA CR-V, K6 & K8 REAR TRAILING ARM BUSH REMOVER / INSTALLER JP PAT. 3126495
 PAT. M296812
 HONDA CR-V, K6 & K8 後游臂鐵套拆裝工具組

H.C.B-A7003 P227
 HONDA ACCORD UPPER CONTROL ARM BUSH REMOVER / INSTALLER (AFTER YEAR 2004)
 USA PAT.
 HONDA 雅哥 (2004 年後) 上三角架鐵套拆裝工具組

H.C.B-A7004 P228
 ACCORD AIR-CONDITIONER PANEL EXTRACTOR
 雅哥冷氣面板拆卸器

H.C.B-A7005 P228
 HONDA BELT TENSIONER WRENCH
 喜美8代 (1800 c.c., 2000 c.c.) 皮帶張力器調整扳手

H.C.B-B7005 P228
 HONDA BELT TENSIONER WRENCH
 喜美8代 (1800 c.c., 2000 c.c.) 皮帶張力器調整扳手

H.C.B-A7006 P228
 UNIVERSAL FLYWHEEL HOLDING TOOL
 通用型飛輪阻擋器

H.C.B-A7007 P229
 HONDA (K10 / CR-V) LOWER CONTROL ARM BUSH REMOVER / INSTALLER
 HONDA (K10 / CR-V) 三角架鐵套拆裝工具組

H.C.B-A7008 P229
 HONDA ACCORD AXLE BALL JOINT REMOVAL / INSTALLATION TOOL KIT
 HONDA 雅哥仰角球頭拆裝工具組

H.C.B-A7009 P230
 HONDA (CIVIC 7) (FERIO 1700 c.c. K10) FRONT AXLE BALL JOINT REMOVAL / INSTALLATION
 TOOL KIT
 HONDA (CIVIC 7) (FERIO 1700 c.c. K10) 前仰角球接頭拆裝工具組

H.C.B-A7010 P230
 HONDA WIPER SPRINKLER HEAD ADJUSTER
 HONDA 雨刷調整器

H.C.B-A7011 P231
 HONDA ADJUSTABLE FUEL TANK LID REMOVER / INSTALLER
 HONDA 燃油濾清器鎖附螺帽拆裝工具

H.C.B-A7012 P231
 HONDA FRONT / REAR AXLES WHEEL BEARING REMOVAL / INSTALLATION TOOL KIT
 HONDA 前/後輪軸培林拆裝工具組

H.C.B-A7013 P232
 HONDA SUBFRAME BUSH REMOVAL AND INSTALLATION TOOL KIT (HYDRAULIC, 3/8" ADAPTOR)
 HONDA 三角架鐵套拆裝工具組 (油壓, 3/8" 接頭)

H.C.B-A7014 P232
 HONDA CIVIC R18A1 CRANKSHAFT REAR OIL SEAL INSTALLATION TOOL KIT
 HONDA CIVIC R18A1 曲軸後油封安裝工具 (8/9 代)

VOLVO REPAIR TOOL
VOLVO 修護工具 (P234~240)

H.C.B-A1355 P234
 VOLVO BALL JOINT REMOVER
 VOLVO 球接頭拆卸器

H.C.B-A1358 P234
 VOLVO DIFFERENTIAL SEALING NUT WRENCH
 VOLVO 差速器密封環螺帽扳手

H.C.B-A1359 P234
 VOLVO DIESEL FILTER WRENCH
 VOLVO 柴油濾心扳手

H.C.B-A1360 P235
 VOLVO FUEL TANK LOCKING RING TOOL
 VOLVO 油箱蓋拆裝器

H.C.B-A1361 P235
 VOLVO CYLINDER HEAD REMOVER
 VOLVO 汽缸蓋拆卸鉗

H.C.B-A1362 P235
 VOLVO TANK LID REMOVER / INSTALLER
 VOLVO 油箱蓋拆裝器

H.C.B-A1378 P236
 VOLVO FUEL PUMP TANK LID WRENCH
 VOLVO 油箱蓋拆卸器

H.C.B-A1381 P236
 VOLVO FRONT STRUT LOWER NUT WRENCH
 VOLVO 避震器拆裝套筒

H.C.B-A1382 P236
 VOLVO IDLER WRENCH
 VOLVO 惰輪扳手

H.C.B-A1306 P237
 VOLVO COMPUTER CONTROL BOX REMOVER / INSTALLER
 VOLVO 電腦控制模組拆裝器

H.C.B-A1308 P237
 VOLVO SERPENTINE BELT TOOL
 VOLVO 惰輪調整扳手

H.C.B-A1069 P237
 VOLVO CAMSHAFT / CRANKSHAFT ALIGNMENT TOOL
 VOLVO 正時工具組

H.C.B-A1395 P238
 VOLVO CRANKSHAFT PULLEY HOLDING TOOL
 VOLVO 曲軸皮帶盤支撐扳手

H.C.B-A1406 P238
 LAND ROVER / JAGUAR / VOLVO (T6) CAMSHAFT ALIGNMENT TOOL KIT
 LAND ROVER / JAGUAR / VOLVO (T6) 凸輪軸正時工具組

H.C.B-A1427 P238
 VOLVO DIESEL PUMP TANK LID WRENCH
 VOLVO 柴油幫浦油箱蓋拆裝器

H.C.B-A1447 P239
 VOLVO FRONT SUSPENSION SHOCK ABSORBER SPRING COMPRESSOR
 VOLVO 前懸吊系統避震器彈簧壓縮工具

H.C.B-A1545 P239
 VOLVO TIMING TOOL KIT (T4 / T5)
 VOLVO 正時工具組 (T4/ T5)



010
HWANG CHERNG BIN
 Specialty Tools Inc.

目錄索引
Index

Index

H.C.B-A1564 P239
 VOLVO CRANKSHAFT PULLEY HOLDER
 VOLVO 曲軸支撐扳手

New **H.C.B-A1619** P240
 VOLVO B4204 (8-SPEED TRANSMISSION) CAMSHAFT ALIGNMENT TOOL KIT
 VOLVO B4204 (8速變速箱) 正時工具組

New **H.C.B-A1638** P240
 VOLVO / FORD / CHRYSLER / DODGE DUAL-CLUTCH TRANSMISSION REMOVAL / INSTALLATION TOOL
 VOLVO / FORD / CHRYSLER / DODGE 雙離合器變速箱拆裝工具

New **H.C.B-A1660** P240
 VOLVO HEATER BLOWER REMOVAL / INSTALLATION TOOL
 VOLVO 冷氣鼓風機拆裝工具

H.C.B-A2202 P244
 FENDER ROLLER TOOL
 輪弧擴張器

H.C.B-A1026 P244
 AXLE BEARINGS EXTRACTION/ INSTALLATION TOOL KIT
 仰角培林拆裝組

H.C.B-A1056 P244
 SOCKET TOOL (FOR FWD ONLY)
 中華百利 800c.c. 四輪傳動專用套筒

H.C.B-A1057 P245
 NISSAN, SUZUKI SOCKET TOOL (FOR FWD ONLY)
 NISSAN, SUZUKI 四輪傳動專用套筒

H.C.B-A1084 P245
 MITSUBISHI WAGON (CANTER) WHEEL BALANCE ADJUSTER
 三菱卡車 (堅達) 校輪盤

H.C.B-A1374 P245
 UNIVERSAL WHEEL BALANCE ADJUSTER
 多功能校輪盤

H.C.B-B1374 P245
 UNIVERSAL WHEEL BALANCE ADJUSTER
 多功能校輪盤

H.C.B-C1374 P246
 UNIVERSAL WHEEL BALANCE ADJUSTER
 多功能校輪盤

H.C.B-A1086 P246
 DUST SHIELD INSTALLER
 防塵套張力擴張器

H.C.B-A1086-1 P246
 DUST SHIELD KIT
 可擴性張力防塵套

H.C.B-A1086-3 P247
 STEERING KNUCKLE DUST SHIELD KIT
 方向機防塵套

H.C.B-A1086-4 P247
 STEERING KNUCKLE DUST SHIELD INSTALLER
 方向機防塵套擴張器

H.C.B-A1095-4H P247
 EXPELLER BELL FOR HUB EXTRACTION (4 HOLES)
 輪軸拆卸器 (4 孔)

H.C.B-A1095-5H P247
 EXPELLER BELL FOR HUB EXTRACTION (5 HOLES)
 輪軸拆卸器 (5 孔)

H.C.B-A1503 P248
 TOYOTA HIACE AXLE EXTRACTOR PAT.M253503
 TOYOTA HIACE 輪軸拆卸器

H.C.B-B1503 P248
 UNIVERSAL AXLE EXTRACTOR (SLIDE HAMMER) PAT.M253503
 通用輪軸拆卸器 (滑錘式)

H.C.B-C1503 P249
 UNIVERSAL AXLE EXTRACTOR (HYDRAULIC) PAT.M253503
 通用輪軸拆卸器 (液壓式)

H.C.B-A1096 P249
 EXPELLER BELL FOR HUB EXTRACTION (HYDRAULIC) PAT. M 253503
 油壓輪軸拆卸組

GENERAL CHASSIS REPAIR TOOL
一般修護工具 底盤 (P242~269)

H.C.B-A1005 P242
 ROLLER STITCHER PAT.155302
 輪胎補胎修補器 (專利品)

H.C.B-A1006 P242
 ROLLER STITCHER PAT.155302
 輪胎補胎修補器 (專利品)

H.C.B-A1007 P242
 ANGLE ADJUSTER
 仰角校正器

H.C.B-A1007-8-6 P242
 6 HOLES CONVEX PLATE
 六孔凸型盤

New **H.C.B-A2311** P243
 WHEEL ALIGNMENT
 四輪定位儀

H.C.B-A2057 P243
 SIMPLE MERCURY GAUGE (6°)
 簡易式水銀錶 (6°)

H.C.B-A2175 P243
 GAUGE FOR CAMBER, CASTER & KING PIN
 大王銷檢查表

H.C.B-A1060 P243
 SSANGYONG BUSH EXTRACTION/ INSTALLATION TOOL KIT
 中華昇陽三角架鐵套拆裝工具組



010
HWANG CHERNG BIN
 Speciality Tools Inc.

SINCE 1990

Index

H.C.B-A2037 P249	H.C.B-B1192 P254
HUB SLIDE HAMMER PULLER (5 HOLES) 前後軸通用倒盾組 (5 孔)	JEEP WRANGLER FRONT SUB-FRAME BALL JOINT EXTRACTOR/ INSTALLER (ACCESSORY) 藍哥前三角架球接頭拆裝工具組 (配件)
H.C.B-B2037 P249	H.C.B-A1254 P254
HUB SLIDE HAMMER PULLER (5 HOLES) 前後軸通用倒盾組 (5 孔)	PEUGEOT BALL JOINT SOCKET (Dr. 1/2", 4 TEETH, 52 mm) 標緻球接頭拆裝套筒 (Dr. 1/2", 4 齒, 52 mm)
H.C.B-C2037 P250	New H.C.B-A2308 P255
PROPELLER SHAFT HAMMER PULLER (ROPE) 前後軸通用倒盾組 (鋼索式)	HYDRAULIC BALL JOINT SEPARATOR (8 TONS) 油壓球接頭拆卸器 (8 噸)
H.C.B-A2040 P250	H.C.B-B2122 P255
HUB SLIDE HAMMER PULLER (4 HOLES) 前後軸通用倒盾組 (4 孔)	BALL JOINT SEPARATOR (19 mm) 橫拉桿球接頭拆卸器 (19 mm)
H.C.B-B2040 P250	H.C.B-C2122 P255
HUB SLIDE HAMMER PULLER (4 HOLES) 前後軸通用倒盾組 (4 孔)	BALL JOINT SEPARATOR (NARROW TYPE) 橫拉桿球接頭拆卸器 (窄版)
H.C.B-A2041 P250	H.C.B-A2044 P255
FRONT WHEEL DRIVE AXLES PULLER 傳動軸倒盾組 (方形盤)	AIR PRESSURE DISK BRAKE CALIPER RETURN TOOL 氣壓式後輪碟式分泵回復器
H.C.B-B2041 P250	H.C.B-A2052 P255
FRONT WHEEL DRIVE AXLES PULLER 傳動軸倒盾組 (方形盤)	METAL T HANDLE RASP EYE TOOL 補胎鑽
H.C.B-A1116-36H P250	H.C.B-A2053 P256
ALUMINUM RETAINING RING ADJUSTMENT TOOL (CEMB) 鋁圈校正器-36H	METAL T HANDLE CLOSED EYE TOOL 補胎針
H.C.B-A1116-38H P251	H.C.B-A2055 P256
ALUMINUM RETAINING RING ADJUSTMENT TOOL (FAIP, CORGHI) 鋁圈校正器-38H	SPRING COMPRESSOR (STAND) 立式彈簧壓縮器
H.C.B-A1116-40H P251	H.C.B-A2071 P256
ALUMINUM RETAINING RING ADJUSTMENT TOOL (HOFFMAN, HUNTER) 鋁圈校正器-40H	PEUGEOT / CITROEN PENTAGON BRAKE SOCKET (19 mm) 標緻 / 雪鐵龍 5 角煞車套筒 (19 mm)
H.C.B-A1163 P251	H.C.B-A2072 P256
MITSUBISHI GALANT REAR AXLES BUSH REMOVER/INSTALLER PAT. PEN 三菱GALANT 後羊角鐵套拆裝工具組	PENTAGON SOCKET BIT FOR GIRLING BRAKES (Dr. 1/2", 10 mm) 5 角煞車套筒 (Dr. 1/2", 10 mm)
H.C.B-A1354 P252	H.C.B-A2079 P256
TOYOTA (4WD / PRERUNNER) FRONT LOWER SUSPENSION ARM BUSH EXTRACTOR / INSTALLER TOYOTA (4WD / PRERUNNER) 前三角架控制臂鐵套拆裝組	MULTI-PURPOSE INNER TIE ROD TOOL (33-42 mm) 方向機舵桿扳手 (通用型) (33-42 mm)
H.C.B-B1354 P252	H.C.B-B2079 P257
TOYOTA (4WD / PRERUNNER) FRONT LOWER SUSPENSION ARM BUSH EXTRACTOR / INSTALLER TOYOTA (4WD / PRERUNNER) 前三角架控制臂鐵套拆裝組	MULTI-PURPOSE INNER TIE ROD TOOL (36-42 mm) 方向機舵桿扳手 (36-42 mm)
H.C.B-A1173 P253	H.C.B-C2079 P257
PEUGEOT (406) BUSH EXTRACTION/ INSTALLATION TOOL KIT 標緻 (406) 三角架鐵套拆裝器	TRACK ROD END REMOVER/INSTALLER (35~45 mm) 方向機舵桿扳手 (35 mm~45 mm)
H.C.B-A1177 P253	H.C.B-D2079 P257
TOYOTA ZACE/DAF BALL JOINT EXTRACTOR (32 mm) TOYOTA 瑞獅/DAF 方向機主機球頭拆卸器 (32 mm)	TRACK ROD END REMOVER / INSTALLER (45 mm~50 mm) 方向機舵桿扳手 (45 mm~50 mm)
H.C.B-A1191 P253	H.C.B-A2088 P258
UNIVERSAL BALL JOINT SEPERATOR (22 mm) 萬用球接頭拆裝工具組 (22 mm)(橫拉桿)	SUZUKI AXLE NUT SOCKET (8 TEETH) 金吉星傳動軸專用套筒 (8 齒)
H.C.B-A1194 P253	H.C.B-A2099 P258
UNIVERSAL BALL JOINT SEPERATOR (20 mm) 立式橫拉桿球頭拆卸器 (20 mm)	FRONT WHEEL DRIVE AXLE PULLER 傳動軸滑鏈組 (鋼索式)
H.C.B-A1192 P254	New H.C.B-C2095 P258
JEEP WRANGLER FRONT SUB-FRAME BALL JOINT EXTRACTOR / INSTALLER 藍哥前三角架球接頭拆裝工具組	PNEUMATIC HYDRAULIC MACPHERSON SPRING DUMPER COMPRESSOR DE.PAT. TW PAT. M518188 CE 氣動多功能油壓彈簧避震器拆裝器



New H.C.B-B2095 P259	H.C.B-F1168 P264
HYDRAULIC MACPHERSON SPRING DUMPER COMPRESSOR DE.PAT. TW PAT.M518188 CE 多功能油壓彈簧避震器拆裝器	UNIVERSAL BALL JOINT SERVICE KIT PAT M.333280 專利型萬象十字接頭拆卸器
H.C.B-A2095 P259	H.C.B-A2262 P265
HYDRAULIC MACPHERSON SPRING DUMPER COMPRESSOR 多功能油壓彈簧避震器拆裝器	UNIVERSAL STEERING KNUCKLE SPREADER 綜合型仰角撐開工具組
H.C.B-C2184 P260	H.C.B-A2264 P265
6 PCS IMPACT SOCKET KIT (Dr. 1/2", MS17&15/17/19/21/22 mm) 6 PCS 輪胎套筒組 (Dr. 1/2", MS17&15/17/19/21/22 mm)	CLIC & CLIC-R HOSE CLAMP PLIERS 防塵套裝束鉗
H.C.B-A2184 P260	H.C.B-A1573 P265
3 PCS THIN WALL DEEP IMPACT SOCKET KIT (Dr. 1/2") (17 mm/19 mm/21 mm) 3 PCS 輪胎套筒組 (Dr. 1/2") (17 mm/19 mm/21 mm)	TOYOTA CAMRY REAR AXLES BUSH REMOVAL / INSTALLATION TOOL KIT TOYOTA CAMRY 後仰角鐵套拆裝工具組
H.C.B-B2184 P260	H.C.B-A2277 P266
ALLOY WHEEL DEEP IMPACT SOCKET KIT 150 mm (L) (Dr. 1/2", 5 PCS) 氣動輪胎套筒組150 mm 長 (Dr. 1/2", 5 PCS)	Twist Axle Spindle Rethreading Kit (9 PCS) 傳動軸 (輪軸) 螺牙修復器 (9 PCS)
H.C.B-A2183 P260	H.C.B-A2293 P266
HYDRAULIC STEERING SYSTEM PRESS TOOL KIT (47 PCS) 萬用型鐵套拆裝組 (油壓式) (47 PCS)	INNER BEARING RACE EXTRACTOR KIT 軸承內圈環拔卸器
H.C.B-B2183 P261	H.C.B-A1554 P267
HYDRAULIC BUSH EXTRACTOR (EXTRA LARGER PARTS) 油壓式鐵套拆裝器 (加大配件)	HYDRAULIC CYLINDER HOIST STAND (50 mm) 油壓缸支撐架 (50 mm)
H.C.B-C2183 P261	H.C.B-B1554 P267
STEERING SYSTEM PRESS TOOL (57 PCS) 手動式汽車拉桿避震鐵套更換工具 (57 PCS)	HYDRAULIC CYLINDER HOIST STAND (73 mm) 油壓缸支撐架 (73 mm)
H.C.B-D2183 P261	New H.C.B-A1612 P268
HYDRAULIC STEERING SYSTEM PULL TOOL KIT (49 PCS) 油壓式汽車拉桿避震鐵套更換工具 (49 PCS)	MITSUBISHI SAVRIN REAR TRAILING ARM BUSHING REMOVAL/ INSTALLATION TOOL KIT 三菱SAVRIN 後三角架鐵套拆裝工具組
H.C.B-E2183 P262	New H.C.B-A1665 P268
UNIVERSAL SLEEVE REMOVAL / INSTALLATION TOOL KIT (26 PCS) 中空油壓式汽車拉桿避震鐵套更換組(全車系)	UNIVERSAL HYDRAULIC PRESSURE KIT 通用油壓組
H.C.B-A1416 P262	New H.C.B-A1623 P269
SUZUKI JIMNY FRONT WHEEL AXLE NUT SOCKET (Dr. 1/2") SUZUKI JIMNY 仰角前輪軸承螺帽套筒 (Dr. 1/2")	TOYOTA REAR AXLE SUSPENSION BUSH REMOVAL/ INSTALLATION TOOL KIT TOYOTA 後橋懸掛鐵套拆裝工具組
H.C.B-A1445 P262	New H.C.B-A2315 P269
UNIVERSAL SUSPENSION ARM LEVER PAT.M450505 撬棒	10 PCS AIR HAMMER W/AIR CHISEL KIT 10 PCS 綜合型氣動鎚組
New H.C.B-C1445 P263	
UNIVERSAL SUSPENSION ARM LEVER (MULTIPLE) PAT.M450505 撬棒 (多角度)	
H.C.B-A1457 P263	
TOYOTA HIACE FRONT WHEEL BEARING NUT SOCKET TOYOTA HIACE 前輪軸承螺帽套筒	
H.C.B-A2231 P263	
WHEEL HUB NUT SOCKET KIT (Dr. 3/4") (8 PCS) 輪軸螺帽套筒組 (Dr. 3/4") (8 PCS)	
H.C.B-A2234 P264	
FORD MONDEO REAR SUB-FRAME BUSH REMOVAL/ INSTALLATION TOOL KIT FORD MONDEO 後三角架鐵套拆裝工具組	
H.C.B-A1467 P264	
MITSUBISHI (VIRAGE / LANCER) REAR TRAILING ARM BUSH REMOVER/ INSTALLER MITSUBISHI (VIRAGE / 菱帥) 後游臂鐵套拆裝工具組	



010
HWANG CHERNG BIN
 Speciality Tools Inc.

SINCE 1990

Index

GENERAL ENGINE REPAIR TOOL
一般修護工具引擎 (P271~327)

- H.C.B-A1081** P271
 ADJUSTABLE UNIVERSAL CAMSHAFT PULLEY HOLDING TOOL TW PAT. 227176 USA PAT.7069821
 專利可調式皮帶盤支撐扳手
- H.C.B-A1049** P272
 UNIVERSAL CAMSHAFT PULLEY HOLDING TOOL
 皮帶盤支撐扳手
- H.C.B-A2134** P272
 UNIVERSAL TWIN/4 CAM LOCK (GAS AND DIESEL ENGINE)
 萬用雙凸輪軸/4 凸輪軸正時工具 (適用汽油與柴油引擎)
- H.C.B-A1388** P272
 ROVER KV6 PETROL/ROEWE 750 ENGINE TIMING KIT (13 PCS)
 ROVER KV6 汽油/ROEWE 750 引擎正時工具組 (13 PCS)
- H.C.B-A2198** P272
 CAMSHAFT SEAL REPLACER
 凸輪軸油封拆裝器
- H.C.B-A2171** P273
 PETROL ENGINE CAM LOCKING/SETTING TOOL AND FLYWHEEL HOLDING TOOL KIT
 汽油引擎雙凸輪軸固定工具及飛輪固定工具組
- H.C.B-A4001** P273
 RENAULT TIMING TOOL KIT
 雷諾正時工具組
- H.C.B-A4002** P274
 SETTING/LOCKING TOOL KIT FOR VAG, V6, TDI, PETROL ENGINE
 VAG, V6, TDI 柴油引擎正時工具組
- H.C.B-A4004** P274
 CITROEN & PEUGEOT ENGINE TIMING TOOL KIT
 雪鐵龍/標緻引擎正時工具組
- H.C.B-A4005** P274
 VAUXHALL/OPEL ENGINE TIMING TOOL
 VAUXHALL/OPEL 引擎正時工具組
- H.C.B-A4006** P275
 TIMING LOCKING TOOL KIT (8 PCS)
 正時工具組 (8 PCS)
- H.C.B-A4007** P275
 FORD & MAZDA ENGINE TIMING TOOL KIT
 福特 & 馬自達引擎正時工具組
- H.C.B-A4008** P276
 FIAT 1.9D/TD ENGINE TIMING TOOL KIT
 FIAT 1.9D/TD 正時工具組
- H.C.B-A4009** P276
 RENAULT/VAUXHALL/OPEL/NISSAN DIESEL ENGINE TIMING TOOL KIT
 RENAULT/VAUXHALL/OPEL/NISSAN 柴油引擎正時工具組
- H.C.B-A4010** P276
 RENAULT/VOLVO 2.0 16V ENGINE TIMING TOOL KIT
 RENAULT/VOLVO 2.0 16V 引擎正時工具組
- H.C.B-A4011** P277
 CITROEN / PEUGEOT ENGINE TIMING TOOL KIT
 雪鐵龍/標緻引擎正時工具組

- H.C.B-A4012** P277
 CITROEN / PEUGEOT ENGINE TIMING TOOL KIT
 雪鐵龍/標緻正時工具組
- H.C.B-A4014** P277
 VAUXHALL DIESEL SETTING/LOCKING TOOL KIT
 VAUXHALL 柴油引擎正時工具組
- H.C.B-A1643** P278
 PSA/PEUGEOT/CITROEN 1.0/1.2 VVT PETROL ENGINE TIMING TOOL KIT
 PSA/PEUGEOT/CITROEN 1.0/1.2 VVT 汽油引擎正時工具組
- H.C.B-A1571** P278
 VAUXHALL/OPEL/CHEVROLET/SAAB/ALFA/FIAT PETROL ENGINE TIMING TOOL KIT
 科魯茲/飛雅特/歐寶汽油引擎工具組
- H.C.B-A1543** P279
 CUMINS TIMING TOOLS
 CUMINS 正時工具組
- H.C.B-A2214** P279
 OPEL 2.2 16V TWIN CAM TIMING TOOL KIT
 OPEL 2.2 16V TWIN CAM 引擎正時工具
- H.C.B-A2216** P280
 FIAT/ALFA ROMEO/LANCIA TIMING TOOL KIT
 飛雅特/愛快羅密歐/蘭吉雅正時工具組
- H.C.B-A2199** P280
 RENAULT ENGINE TIMING TOOL KIT
 雷諾引擎正時工具組
- H.C.B-B2199** P281
 RENAULT ENGINE TIMING TOOL KIT
 雷諾引擎正時工具組
- H.C.B-A2123** P281
 UNIVERSAL CAMSHAFT ALIGNMENT TOOL
 圓孔型雙凸輪軸固定器
- H.C.B-A2221** P281
 UNIVERSAL CRANKSHAFT/CAMSHAFT SEAL REMOVER/INSTALLER KIT
 萬用凸輪軸/曲軸油封拆裝工具組
- H.C.B-A1189** P281
 GEAR PULLER (THIN JAWS)
 曲軸正時皮帶盤拆裝工具組 (薄爪)
- H.C.B-A1143** P282
 CHRYSLER CRANKSHAFT PULLEY REMOVER/INSTALLER
 克萊斯勒皮帶盤拆卸器
- H.C.B-B1143** P282
 CHRYSLER CRANKSHAFT PULLEY REMOVER/INSTALLER
 克萊斯勒皮帶盤拆卸器
- H.C.B-A1115** P282
 UNIVERSAL CRANKSHAFT PULLEY & CAMSHAFT PULLEY PULLING AID PAT. M 253504
 可換式皮帶盤拆卸組
- H.C.B-A2179** P283
 UNIVERSAL CRANK PULLEY HOLDING PLATE
 固定式曲軸皮帶盤拆裝組
- H.C.B-A1440** P283
 MAZDA 3/MAZDA 5/FORD FOCUS AIR CONDITIONING COMPRESSION BELT INSTALLER
 MAZDA 3/MAZDA 5/FORD FOCUS 冷氣壓縮機皮帶安裝器
- H.C.B-A2243** P283
 BELT INSTALLING TOOL KIT
 皮帶安裝工具組
- H.C.B-A1054-2** P284
 UNIVERSAL SEPARATOR (R2) PAT. 172921
 萬用拆卸器 (R2)



010

HWANG CHERNG BIN
Specialty Tools Inc.

目錄索引
Index

Index

H.C.B-A1054-4 P284	H.C.B-B1223 P289
STEERING WHEEL PULLER BOLT (EXTENDED) 方向盤拆卸器螺絲 (加長型)	NISSAN SPECIAL 6-POINT-STAR IMPACT SOCKET (Dr. 1/2", M12S) NISSAN 特殊套筒 (Dr. 1/2", M12S)
H.C.B-A1157 P284	H.C.B-C1223 P289
GEAR TYPE ENGINE MOUNTING BRACKET 齒輪式引擎拆裝架	NISSAN SPECIAL 6-POINT-STAR IMPACT SOCKET (Dr. 1/2", 8 S) NISSAN 特殊套筒 (Dr. 1/2", 8 S)
H.C.B-A1157-1 P284	H.C.B-D1223 P290
MULTIPLE FUNCTION TABLE GEAR-TYPE ENGINE MOUNTING BRACKET 多用途桌上型引擎拆裝架	SPECIAL 6-POINT SOCKET (Dr. 1/2", 6 S) 特殊套筒 (Dr. 1/2", 6 S)
H.C.B-A1157-2 P284	H.C.B-E1223 P290
FIXING BASE 固定式底座	NISSAN SPECIAL 3-POINT-STAR IMPACT SOCKET (Dr. 1/2", 8 TS) NISSAN 特殊套筒 (Dr. 1/2", 8 TS)
H.C.B-A1157-3 P284	H.C.B-A1098 P290
SLOP OIL PAN 廢油盤	HAND HOLDING VALVE SPRING COMPRESSOR 握把式汽門彈簧壓縮組
H.C.B-A1097 P285	H.C.B-A2116 P290
UNIVERSAL GEAR TYPE ENGINE K/D RACK USA PAT. PEN PAT.089901 齒輪式引擎拆裝架	VALVE SPRING COMPRESSOR KIT 免拆式凡爾鈔
H.C.B-A2014 P285	H.C.B-B1376 P291
FOLDABLE ENGINE CRANE (1 TON) 1 噸引擎吊架	UNIVERSAL VALVE SPRING REMOVER/INSTALLER (22 PCS) PAT.M411316 & M409923 DE PAT. 多功能免拆式汽門彈簧拆裝工具組 (22 PCS)
H.C.B-A2014-1 P285	H.C.B-A1376 P291
8 TONS HYDRAULIC JACK, LONG RAM 8 噸千斤頂	UNIVERSAL VALVE SPRING REMOVER/INSTALLER PAT. M411316& M409923 DE PAT. 多功能免拆式汽門彈簧拆裝工具組
H.C.B-B2014 P286	H.C.B-A2156 P292
UNIVERSAL ENGINE LIFTING BRACKET 萬用發動機維修起吊支架	VALVE SPRING COMPRESSOR 萬能凡爾鈔
H.C.B-A2016 P286	H.C.B-A2223 P292
ENGINE STABILIZER BAR 引擎平衡桿 (固定架)	VALVE OIL SEAL REMOVER/ INSTALLER KIT 汽門油封拆裝組
H.C.B-B2016 P286	H.C.B-A1193 P292
ENGINE STABILIZER BAR (EXTENDED FIX BASE) 引擎平衡桿 (加高型固定架)	CADILLAC NORTHSTAR/OLDSMOBILE AURORA WATER PUMP R&R SOCKET (4600 c.c.) (Dr. 1/2", 6 TEETH) 凱迪拉克 NORTHSTAR/OLDSMOBILE AURORA 水幫浦拆裝套筒(4600 c.c.) (Dr. 1/2", 6 齒)
H.C.B-C2016 P287	H.C.B-A1142 P292
UNIVERSAL TRANSVERSE ENGINE STABILIZER BAR 萬用可調式引擎平衡桿	GAS REVOLUTION HOLDER BAT 油門轉速固定器
H.C.B-D2016 P287	H.C.B-B2026 P293
DOUBLE HOOKS ENGINE STABILIZER BAR 雙勾引擎平衡桿	HEAVY DUTY SPARK PLUG FIRING TESTER 調整式火花測試器
H.C.B-E2016 P287	H.C.B-A2033 P293
VW SEDAN ENGINE STABILIZER BAR VW 轎車引擎平衡桿	STRAIGHT EDGE 汽缸平面量規壓尺
H.C.B-F2016 P288	H.C B-A2027 P293
UNIVERSAL ENGINE STABILIZER BAR (TRI-BRANCHES) 萬用引擎平衡桿 (三叉式)	SEAL PULLER 油封拉拔器 (雙頭大型)
H.C.B-G2016 P288	H.C.B-A1166 P293
VW T4 ENGINE STABILIZER BAR VW T4 引擎平衡桿	HYUNDAI TRAJET (DIESEL ENGINE) OIL FILTER WRENCH (Dr. 1/2", 15 POINTS, 82 mm) HYUNDAI TRAJET (柴油休旅車) 機油芯拆裝器 (Dr. 1/2", 15 角, 82 mm)
H.C.B-H2016 P288	H.C.B-A2018-4 P294
ENGINE LIFTING BAR (IMPROVEMENT) 引擎平衡桿 (完美改良型)	MITSUBISHI OIL FILTER WRENCH (Dr. 1/2", 14 POINTS, 66 mm) 三菱機油芯扳手 (Dr. 1/2", 14 角, 66 mm)
H.C.B-B1167 P289	H.C.B-A2018-6 P294
TOYOTA DIESEL FUEL WRENCH SOCKET (FLUID RESERVOIR ON CONDENSER) (17 mm) TOYOTA 柴油冷凝器貯油槽高扳手 (17 mm)	VW OIL FILTER WRENCH (Dr. 1/2", 9 RIBS, 95 mm) VW 機油芯扳手 (Dr. 1/2", 9 齒, 95 mm)
H.C.B-A1223 P289	H.C.B-A2018-7 P294
TOYOTA ALTIS SPECIAL 6-POINT SOCKET (Dr. 1/2", 10 S) TOYOTA ALTIS 特殊套筒 (Dr. 1/2", 10 S)	RENAULT OIL FILTER WRENCH (Dr. 1/2", 6 RIBS, 66 mm) 雷諾機油芯扳手 (Dr. 1/2", 6 齒, 66 mm)



010
HWANG CHERNG BIN
 Speciality Tools Inc.

SINCE 1990

Index

H.C.B-A2018-8	P294	H.C.B-A2063	P299
NISSAN OIL FILTER WRENCH (15 POINTS, 80 mm) NISSAN 機油芯扳手 (15 角, 80 mm)		COMPRESSION TESTER KIT 改良型汽缸壓力錶	
H.C.B-A2018-9	P295	H.C.B-A2225	P299
NISSAN OIL FILTER WRENCH (15208 53J00) (14 POINTS, 64 mm) NISSAN 機油芯扳手 (15208 53J00) (14 角, 64 mm)		DIESEL ENGINE COMPRESSION TESTER KIT 柴油汽缸壓力錶	
H.C.B-A2018-10	P295	H.C.B-A2065	P300
NISSAN OIL FILTER WRENCH (15208-31U01 MD136466) (14 POINTS, 63 mm) NISSAN 機油芯扳手 (15208-31U01 MD136466) (14 角, 63 mm)		ENGINE OIL PRESSURE TESTER 機油壓力測試錶	
H.C.B-A2018-15	P295	H.C.B-A2143	P300
MITSUBISHI SAVRIN (2000 c.c.) OIL FILTER WRENCH (15 POINTS, 79 mm) 三菱SAVRIN (2000 c.c.) 機油芯扳手 (15 角, 79 mm)		COOLING SYSTEM TESTERS (7 PCS) 水箱壓力錶組 (快速型) (7 PCS)	
H.C.B-A2018-16	P295	H.C.B-A2096	P300
SUZUKI SWIFT OIL FILTER WRENCH (Dr. 1/2", 14 POINTS, 65 mm) SUZUKI SWIFT 機油芯扳手 (Dr. 1/2", 14 角, 65 mm)		UNIVERSAL RADIATOR PRESSURE TESTER KIT 簡易式水箱測試組	
H.C.B-A1272	P295	H.C.B-A2066	P301
TOYOTA LEXUS OIL FILTER WRENCH (Dr. 3/8", 14 POINTS, 64 mm) TOYOTA LEXUS 機油芯扳手 (Dr. 3/8", 14 角, 64 mm)		VACUUM & FUEL PUMP PRESSURE TESTER 引擎真空與燃油壓力測試錶	
H.C.B-B1272	P296	H.C.B-A2067	P301
TOYOTA LEXUS OIL FILTER WRENCH (Dr. 1/2", 14 POINTS, 64 mm) TOYOTA LEXUS 機油芯扳手 (Dr. 1/2", 14 角, 64 mm)		AUTOMATIC TRANSMISSION & ENGINE OIL PRESSURE TESTER 引擎機油測壓錶	
H.C.B-B1370	P296	H.C.B-A2149	P301
TOYOTA OIL FILTER WRENCH (Dr. 3/8", 14 POINTS, 64.5 mm) TOYOTA 機油芯扳手 (Dr. 3/8", 14 角, 64.5 mm)		EXHAUST BACK PRESSURE GAUGE 排氣背壓錶組	
H.C.B-A1639	P296	H.C.B-A2150	P302
New TOYOTA/LEXUS FUEL TANK LID WRENCH (Dr. 1/2", 24 POINTS) TOYOTA/LEXUS 汽油浮筒拆裝器 (Dr. 1/2", 24 POINTS)		UNIVERSAL RADIATOR PRESSURE TESTER KIT (NYLON 66) (18 PCS) 萬用水箱壓力測試組 (尼龍 66) (18 PCS)	
H.C.B-A2220	P297	H.C.B-C2210	P303
FILTER SOCKET MASTER KIT (7 PCS) 機油芯扳手組 (7 PCS)		RADIATOR PRESSURE TESTER & VACUUM-TYPE COOLING SYSTEM KIT (NYLON 66) (28 PCS) 萬用水箱壓力測試組 (尼龍 66) (28 PCS)	
H.C.B-A2218	P297	H.C.B-A2113	P304
TOYOTA/ NISSAN OIL TUBE REMOVER TOYOTA/ NISSAN 汽油管拆卸器		LEAK-CHECK FOR COMBUSTION 引擎燃燒室測漏組 (藥水型)	
H.C.B-A2172	P297	H.C.B-B2113	P304
MITSUBISHI BELT TENSION ADJUSTER 三菱惰輪皮帶張力調整器		LEAK-CHECK FOR COMBUSTION WITH 3PCS RADIATOR CAP 引擎燃燒室測漏組 (藥水型) 附3 PCS 水箱蓋	
H.C.B-A2058	P297	H.C.B-A2089	P304
UNIVERSAL HOSE CLAMP REMOVER 可彎式喉式管束夾鉗		1/2" M9 CYLINDER HEAD BOLT TOOL (100 mm) 1/2" 12 角軸套筒 (100 mm) (M9)	
H.C.B-B2058	P297	H.C.B-B2089	P305
UNIVERSAL HOSE CLAMP REMOVER 可彎式喉式管束夾鉗		6 PCS TRIPLE SQUARE DRIVE KIT (M6, M8, M10, M12, M14, M16) (Dr. 1/2" x 140 mm) 6 PCS 星形套筒組 (Dr. 1/2" x 140 mm)	
H.C.B-C2058	P298	H.C.B-A2097	P305
UNIVERSAL HOSE CLAMP REMOVER (EXTENDED) 可彎式喉式管束夾鉗 (加大型)		DEEP TWIST SOCKET KIT (Dr. 1/2") 螺旋拆裝器 (Dr. 1/2")	
H.C.B-D2058	P298	H.C.B-A2090	P305
ROPE HOSE CLIP PLIERS 鋼索式管鉗		1/2" x M10S CYLINDER HEAD BOLT TOOL (100 mm) 1/2" x M10S 12 角軸套筒 (100 mm)	
H.C.B-A1365	P298	H.C.B-B2090	P305
PEUGEOT (207, 308, 3008 1.6/HDI) BELT IDLER ADJUSTER PEUGEOT (207, 308, 3008 1.6/HDI) 皮帶惰輪調整扳手		1/2" x M10S CYLINDER HEAD BOLT TOOL (100 mm) 1/2" x M10S 12 角軸套筒 (100 mm)	
H.C.B-A2042	P298	H.C.B-C2090	P305
UNIQUE COMPRESSION TESTER KIT 汽缸壓力錶 (膜片式)		1/2" x M10S CYLINDER HEAD BOLT TOOL (140 mm) 1/2" x M10S 6 角齒輪軸套筒 (140 mm)	
H.C.B-A2054	P299	H.C.B-A1297	P306
GASOLINE ENGINE INJECTING PRESSURE TESTER KIT 汽油燃油壓力試驗器 (全車種)		FLEXIBLE FLARE NUT COMBINATION WRENCH (7 PCS) 彎頭油管扳手 (7 PCS)	



010
HWANG CHERNG BIN
Specialty Tools Inc.

目錄索引
Index

Index

New H.C.B-A2301 P306 75° BOX END & FLEXIBLE GEAR RATCHET WRENCH WITH GO-THROUGH SOCKET KIT (17 PCS) 穿透式套筒組 (17 PCS)	H.C.B-D2121 P313 PORTABLE POWER STATION (FOR VEHICLE) 電霸 (電力士)
New H.C.B-A2302 P306 DOUBLE FLEXIBLE RATCHET FLARE NUT WRENCH (10 x 12 /13 x 14/15 x 17 mm) (3 PCS) 雙搖頭開口油管扳手 (10 x 12 /13 x 14/15 x 17 mm) (3 PCS)	H.C.B-B2119 P313 INFRA-RED TEMPERATURE PICK-UP 紅外線溫度槍
New H.C.B-A2300 P307 FLEXIBLE CROW'S FOOT SOCKET WRENCH KIT (12 PCS) 搖頭鴨掌扳手組 (12 PCS)	H.C.B-A2100 P314 CURRENT LEAKAGE TESTER FOR IGNITION ACTION 漏電測試器
H.C.B-A2197 P307 HEAVY DUTY OIL FILTER CHAIN WRENCH (350 mm) 鏈條式機油濾芯扳手 (350 mm)	H.C.B-A2192 P314 OIL DRAIN REPAIR KIT 油底殼螺絲更換組
H.C.B-B2197 P307 HEAVY DUTY OIL FILTER CHAIN WRENCH (520 mm) 鏈條式機油濾芯扳手 (520 mm)	H.C.B-A1371 P314 ELECTRONIC TORQUE SCREWDRIVER 電子式扭力螺絲起子
H.C.B-A2213 P308 GLOW PLUG SOCKET KIT (5 PCS) (Dr. 1/4", 12 POINTS) 可彎式套筒組 (5 PCS) (Dr. 1/4", 12 角)	H.C.B-B2192 P315 OIL DRAIN REPAIR KIT 油底殼螺絲更換組
H.C.B-A2094 P308 TWO WAY OIL FILTER WRENCH (60~80 mm) 二爪正反轉機油濾芯扳手 (60~80 mm)	New H.C.B-B2160 P315 50L WASTE OIL DRAINER (MANUAL) 手動升降式牛油機 (50 升)
H.C.B-B2094 P308 TWO WAY OIL FILTER WRENCH (80~110 mm) 二爪正反轉機油濾芯扳手 (80~110 mm)	H.C.B-A2160 P315 WASTE OIL DRAINER (80 L) 廢油桶 (80 升)
H.C.B-D2094 P309 TWO WAY OIL FILTER WRENCH (104 mm~150 mm) 二爪正反轉機油濾芯扳手 (104~150 mm)	New H.C.B-A2310 P316 OIL DRAIN PAN 油盤
H.C.B-A1310-14 P309 FLARE NUT WRENCH (Dr. 3/8" x 14 mm) 單開口扳手 (Dr. 3/8" x 14 mm)	New H.C.B-A2312 P316 2L OIL DRAIN PAN 2L 油盤
H.C.B-A1310-17 P309 FLARE NUT WRENCH (Dr. 1/2" x 17 mm) 單開口扳手 (Dr. 1/2" x 17 mm)	H.C.B-A1396 P316 MITSUBISHI/ KIA ENGINE BALANCE SHAFT O-RING REMOVER SOCKET 三菱 / KIA 平衡軸套筒
H.C.B-A2098 P310 HOUSING DISASSEMBLE KIT 端子拆卸盒	H.C.B-A1417 P316 FUEL FILTER LID WRENCH (Dr. 3/8", 108 mm) 汽油箱蓋拆裝器 (Dr. 3/8", 108 mm)
H.C.B-A2114 P310 OIL PAN SEPARATOR TOOL 油底殼密封處分離器	H.C.B-A1418 P317 FUEL FILTER LID WRENCH (Dr. 3/8", 8 RIBS, 109 mm) 汽油箱蓋拆裝器 (Dr. 3/8", 8 齒, 109 mm)
H.C.B-A2125 P310 FAST CHECK WIRE-CLIP 快速查線夾	New H.C.B-C2250 P317 8 PCS SPECIALIST SOCKET KIT (Ribe sockets: 1/2" Dr. x M6S, M8S, M10S, M12S/ Pentagon sockets: 1/2" Dr. x 10, 12, 14, 19 mm) 8 PCS 特殊套筒組 (Ribe sockets: 1/2" Dr. x M6S, M8S, M10S, M12S/Pentagon sockets: 1/2" Dr. x 10, 12, 14, 19 mm)
H.C.B-B2031 P311 UNIVERSAL LINE KIT 萬用線組	H.C.B-A2250 P317 13 PCS SPECIALIST SOCKET KIT 13 PCS 特殊套筒組
H.C.B-C2031 P311 SIMPLY UNIVERSAL LINE KIT 簡易型萬用線組	H.C.B-A2241 P318 PENTAGON SOCKET (Dr. 1/2", 10 mm) 內五角套筒 (Dr. 1/2", 10 mm)
H.C.B-A2121 P312 PORTABLE POWER STATION (FOR SEDAN) 電霸 (一般轎車用)	H.C.B-A2242 P318 PENTAGON SOCKET (Dr. 1/2", 12 mm) 內五角套筒 (Dr. 1/2", 12 mm)
H.C.B-B2121 P312 PORTABLE POWER STATION (FOR VEHICLE) 電霸 (汽油車, 柴油車用)	
H.C.B-C2121 P313 PORTABLE POWER STATION (FOR 230 V/50 Hz) 電霸 (230 V/50 HZ)	



010
HWANG CHERNG BIN
 Speciality Tools Inc.

SINCE 1990

Index

H.C.B-A2249 P318	New	H.C.B-A2297 P324
13 PCS SPECIALIST SOCKET KIT (HEX) 13 PCS 特殊套筒組 (六角)		OIL/BRAKE FLUID INSPECTION SYRINGE (200 ml) 機油 / 剎車油注射器 (200ml)
H.C.B-A1469 P318	New	H.C.B-B2297 P324
7 PCS Dr. 1/4" TX-STAR BALL END INSERT BIT SOCKET KIT 7 PCS Dr. 1/4" 球型扳手		MULTI-PURPOSE SYRINGE (1.5 L) 多功能注射器 (1.5 升)
H.C.B-A2237 P319	New	H.C.B-C2297 P325
DISC BRAKE PISTON TOOL 碟煞活塞調整器		DIESEL / PETROL FUEL SYRINGE (1.5 L) 柴 / 機油真空抽取注射器 (1.5 升)
H.C.B-A2244 P319	New	H.C.B-A2303 P325
DIESEL COMPRESSION TESTER (37 PCS) 柴油測試組 (37 PCS)		ENGINE OIL FUNNEL KIT (7 PCS) 引擎油加油蓋組 (7 PCS)
H.C.B-A2248 P319	New	H.C.B-A2304 P325
GLOW PLUG DRILLING KIT (16 PCS) 預熱塞拔脫器 (16 PCS)		OIL FILLER FUNNEL TOOL KIT (7 PCS) 加油漏斗蓋組 (7 PCS)
H.C.B-A1497 P320	New	H.C.B-A2298 P326
ALUM-A-STACK HYDRAULIC RAM KIT 堆疊式油壓組		BRAKE BLEEDER WRENCH KIT W/ CHECK VALVE 簡易型剎車油更換扳手加附逆止閥配管
H.C.B-A1499 P320		H.C.B-A2290 P326
RENAULT (1.8/2.0 16 V) BELT DRIVE PETROL ENGINE CAMSHAFT SPROCKET LOCKING DEVICE 雷諾正時工具組 (1.8/2.0 16 V)		FLEXIBLE HOSE CLIP NUT DRIVER 軟性套筒起子
H.C.B-A2252 P320		H.C.B-A1611 P326
RETURN FUEL VOLUME TESTER FOR COMMON RAIL INJECTORS (6 V) 柴油燃油測試組 (6 V)		STEERING FIXED BASE 方向盤固定器
H.C.B-A2255 P321	New	H.C.B-B2124 P326
DR. 3/8" AND DR. 1/2" SCREW EXTRACTOR KIT (9 PCS) 螺絲破壞器 (9 PCS)		3/8" OIL DRAIN SOCKET KIT (15 PCS) 3/8" 油底殼螺絲套筒組 (15 PCS)
H.C.B-A2261 P321	New	H.C.B-A2295 P327
UNIVERSAL Dr. 1/2" STUD EXTRACTOR (FOR 6.0 X 12.0) 通用無頭螺絲拔卸器 (FOR 6.0 X 12.0)		AIR BAG TOOL (4 PCS) 安全氣囊工具 (4 PCS)
H.C.B-A2263 P321	New	H.C.B-A2296 P327
UNIVERSAL GM, CHRYSLER, MITSUBISHI HARMONIC DAMPER PULLEY PULLER 通用 GM/CHRYSLER, MITSUBISHI 皮帶輪拆卸工具		HOSE CLAMP PLIER (0-38 mm) 水管夾線鉗 (0-38 mm)
H.C.B-A2266 P322	New	H.C.B-B2296 P327
UNIVERSAL HYDRAULIC FLARING TOOL KIT 液壓夾管成型器		HOSE CLAMP PLIER (22-55 mm) 水管夾線鉗 (22-55 mm)
H.C.B-A1527 P322	New	H.C.B-A2307 P327
PEUGEOT ENGINE MOUNT BUSH REMOVER/ INSTALLER 標緻 (PEUGEOT) 引擎座鐵套拆裝工具組		RATCHET EXHAUST PIPE CUTTER 排氣管切管器
H.C.B-A1531 P323		
INJECTOR RAIL ASSEMBLY REMOVER 噴油嘴拆卸工具		
H.C.B-A1537 P323		
HYUNDAI INJECTOR REMOVER HYUNDAI 噴油嘴拆卸工具		
H.C.B-A2274 P323		
CAM AND CRANKSHAFT SEAL PULLER 曲軸 / 凸輪軸油封拉拔器		
H.C.B-A2279 P323		
UNIVERSAL OIL FUNNEL KIT 萬用型漏斗組		
H.C.B-B2279 P324		
OIL FUNNEL FOR SUBARU SUBARU 漏斗		
H.C.B-C2279 P324		
FLEXIBLE FUNNEL 可彎式漏斗		



010

HWANG CHERNG BIN
Specialty Tools Inc.

目錄索引
Index

Index

GENERAL TRANSMISSION REPAIR TOOL
一般修護工具 變速箱 (P329~333)

H.C.B-A1009	P329
AUTOMATIC TRANSMISSION CLUTCH SPRING COMPRESSOR 自動變速箱離合器壓板拆裝工具	
H.C.B-B1010	P329
TOYOTA/LEXUS AUTOMATIC TRANSMISSION CLUTCH SPRING COMPRESSOR TOYOTA/LEXUS 自動變速箱離合器壓板拆裝工具	
H.C.B-C1010	P329
TOYOTA/LEXUS AUTOMATIC TRANSMISSION CLUTCH SPRING COMPRESSOR (FOUR TEETH) TOYOTA/LEXUS 自動變速箱離合器壓板拆裝工具 (4 齒)	
H.C.B-A1097-5	P329
TOYOTA LEXUS TRANSMISSION HOLDING BASE TOYOTA LEXUS 變速箱拆裝架	
H.C.B-A2009	P329
CLUTCH ALIGNMENT TOOL (IRON) 離合器對孔校正器 (鐵)	
H.C.B-A1015	P330
BLIND HOLE BEARING PULLER 隱蔽型培林拆卸組	
H.C.B-A2115	P330
BLIND HOLE BEARING PULLER 隱蔽型培林拆卸組	
H.C.B-A2013	P331
TRANSMISSION FLOOR JACK (1 TON) 臥式變速箱千斤頂 (1 噸)	
H.C.B-A2035	P331
DOUBLE PISTON TRANSMISSION JACK 雙活塞變速箱千斤頂	
H.C.B-A2159	P331
AIR ASSISTED HIGH LIFT TRANSMISSION JACK 氣壓式變速箱千斤頂	
H.C.B-A2012	P332
VERTICAL TRANSMISSION JACK 立式變速箱千斤頂	
H.C.B-A2185	P332
DOUBLE PISTON TRANSMISSION JACK (5 FEET) PAT. D134321 雙活塞變速箱千斤頂 (5 腳)	
H.C.B-B2009	P333
UNIVERSAL CLUTCH ALIGNMENT TOOL KIT 通用離合器校正工具組	
H.C.B-A2272	P333
MASTER CLUTCH ALIGNMENT RECTIFIER KIT (15 PCS) 離合器中心校正器 (15 PCS)	
H.C.B-A2289	P333
ANGLE TIP LOCK RING PLIERS 平口鋼圈鉗	
New H.C.B-A1637	P333
TRACTOR TRANSMISSION SECOND GEAR SERVICE TOOL 收割機變速箱二檔維修工具	

GENERAL REPAIR EQUIPMENT
一般修護工具 修護設備 (P335~383)

H.C.B-B1022	P335
TURNBUCKLE FOR SHOCK ABSORBER'S TOP LID 避震器上蓋鬆緊器	
H.C.B-A1051-1	P335
PUNCHED BOARD (885 mm x 870 mm) 洞洞板 (3 尺 X 3 尺)	
H.C.B-A1051-2	P335
PUNCHED BOARD (L1800 mm x W865 mm x H20 mm) 洞洞板 (長1800 mm x 寬865 mm x 高20 mm)	
H.C.B-A1051-3	P336
3" FIXED HOOK 3" 洞洞勾	
H.C.B-A1051-4	P336
PUNCHED BOARD (561 mm x 866 mm x 20 mm) 洞洞板 (561mm x 866mm x 20mm)	
H.C.B-A1065	P336
WAGON SUPPORTER 貨車專用安全頂架 (配合平板頂車機使用)	
H.C.B-A1124	P336
FAN CLUTCH OIL 風扇離合器專用油	
H.C.B-A1135-R	P337
THE COMPACT TOOLBOX TROLLEY (RED) 美式工具車 (紅)	
H.C.B-A1073	P337
3-SHELF SERVICE CART (STAINLESS) 三層不銹鋼工具車	
H.C.B-C1076	P337
11-DRAWER ROLLER CABINET 11 抽工具車	
H.C.B-A2010	P338
4-SHELF CART 工具車 (4層開放式附間隔塊)	
H.C.B-A2011	P338
TOOL BOX, 6 DRAWERS (MODEL 300) 6 抽工具車 (300 型)	
H.C.B-A2049	P338
PROFESSIONAL TOOL BOX (7 DRAWERS) 7 層工具車	
H.C.B-A2049-1	P338
220 PCS COMBINATION TOOL KIT 220 件工具組	
H.C.B-A2049-2	P338
245 PCS COMBINATION TOOL KIT 245 件工具組	
H.C.B-A2060	P339
TOOL BOX, 7-DRAWER ROLLER CART (BALL BEARING SLIDE) 7 抽工具車	
H.C.B-B2060	P339
WALL CABINET (W: 660 mm x D: 305 mm x H: 600 mm) 工具壁櫃 (W: 660 mm x D: 305 mm x H: 600 mm)	



010
HWANG CHERNG BIN
 Speciality Tools Inc.

Index

H.C.B-C2060 P339
 TOP TRAY
 上方膠盤

H.C.B-D2060 P339
 (18") SIDE PANEL
 (18") 側板

H.C.B-E2060 P340
 14-DRAWER ROLLER TOOL CABINETS
 14 抽滾輪工具櫃

New H.C.B-F2060 P340
 3-DRAWER DOUBLE SIDED TROLLEY
 3 抽雙開工具車

H.C.B-A2001 P340
 3-SHELF SERVICE CART
 3 層工具車

H.C.B-A2004 P341
 8 PCS SPECIAL SOCKET KIT
 8 PCS 有齒特殊套筒組 (拆天線·後視鏡)

H.C.B-B1117 P341
 GEAR TYPE UNIVERSAL K/D RACK PAT. M 252610 USA PAT. 7093809
 專利齒輪式多功能拆裝器

H.C.B-B1117-1 P341
 DRAIN PAN
 廢油盤

H.C.B-A1117 P342
 GEAR TYPE UNIVERSAL K/D RACK PAT. M 252610 USA PAT. 7093809
 專利齒輪式多功能拆裝器

H.C.B-A1117-1 P342
 MAGNETIC TRAY
 長方形吸盤

H.C.B-A1117-2 P342
 DRAIN PAN
 廢油盤

H.C.B-A1117-3 P342
 MAGNETIC LADDER TYPE T WRENCH FIXING BASE
 T 梯階梯固定座

H.C.B-A1117-4 P343
 500 C-TYPE TRANSMISSION HOLDING BASE PAT. M 270936 USA PAT. 7093809
 500 C 型變速箱固定座

H.C.B-A1117-4-1 P343
 MITSUBISHI VIRAGE 1800 c.c. TRANSMISSION TOOL FITMENT
 MITSUBISHI VIRAGE 1.8 變速箱工具配件

H.C.B-A1117-4-2 P343
 MITSUBISHI FREECA TRANSMISSION TOOL FITMENT
 MITSUBISHI FREECA 變速箱工具配件

H.C.B-A1117-4-3 P343
 AUDI TRANSMISSION TOOL FITMENT
 AUDI 變速箱工具配件

H.C.B-A1117-5 P344
 600 TRANSMISSION HOLDING BASE TW PAT. USA PAT. PEN
 600 □ 型變速箱固定座

H.C.B-A1117-5-1 P344
 MITSUBISHI MG TRANSMISSION TOOL FITMENT
 MITSUBISHI MG 變速箱工具配件

H.C.B-A1117-5-2 P344
 MITSUBISHI 6-SPEED TRANSMISSION TOOL FITMENT
 MITSUBISHI 6 速變速箱工具配件

New H.C.B-A1117-6 P344
 VIRAGE TRANSMISSION TOOL
 VIRAGE 變速箱拆裝工具

H.C.B-B2015 P345
 CAR WASHER (3HP/ 220V)
 高級進口洗車機 (3HP/ 220V)

H.C.B-A2019 P345
 3 TONS FOUR WHEELS HYDRAULIC FLOOR JACK
 3 噸油壓 4 輪千斤頂

H.C.B-A2084 P345
 5 TONS FOUR WHEEL HYDRAULIC FLOOR JACK
 5 噸 4 輪千斤頂

H.C.B-B2043 P346
 ALUMINIUM ALLOY FOUR WHEEL HYDRAULIC FLOOR JACK (FANCY TOOL) (2 TONS)
 鋁合金 4 輪液壓千斤頂 (2 噸)

H.C.B-A2129 P346
 3 TONS JACK
 3 噸千斤頂

H.C.B-A2020 P347
 SCREW DRIVER TOOL KIT (78 PCS)
 星型、E 型起子綜合組 (78 PCS)

H.C.B-A2021 P347
 SOCKET TOOL KIT (34 PCS)
 星型中空、E 型綜合套筒組 (34 PCS)

H.C.B-A2022 P347
 18 PCS IMPACT HEXAGON & TX-STAR WRENCH KIT
 6 角、星型凸套筒組 (18 PCS)

H.C.B-A2023 P348
 UNIVERSAL SOCKET TOOL KIT (12 PCS)
 1/2" 中空全能套筒組 (12 PCS)

H.C.B-A2023-1 P348
 13 PCS 3/8" DRIVE GO-THRU SOCKET WRENCH KIT
 13 PCS 3/8" 中空全能套筒組

H.C.B-A2028 P348
 8 PCS MIRROR POLISHED COMBINATION WRENCH KIT (FINE-TOOTH, 72 TEETH)
 8 PCS 開口止滑迴旋扳手組

H.C.B-A2029 P348
 8 PCS PIN PUNCH KIT
 8 PCS 平沖組

H.C.B-A2038 P349
 AUTOMOTIVE VACUUM TEST KIT
 全配備真空吸力槍組

H.C.B-B2038 P349
 AUTOMOTIVE VACUUM & PRESSURE TEST KIT
 全配備正負壓槍

H.C.B-A2024 P349
 9 PCS BALL-END HEX. KEY KIT
 9 PCS 球型 6 角扳手組

H.C.B-A2039 P349
 FENDER COVERS (870 x 570 mm)
 葉子板護套 (870 x 570 mm)

H.C.B-A2068 P350
 FENDER COVER (1050 x 650 mm)
 葉子板護套 (1050 x 650 mm)

New H.C.B-B2068 P350
 UNIVERSAL FENDER COVERS (1500 mm x 860 mm)
 葉子板護套 (1500 mm x 860 mm)



010
HWANG CHERNG BIN
 Specialty Tools Inc.

目錄索引
Index

Index

H.C.B-A2051 P350 DIODE FLEXIBLE LIGHT 二極體可彎燈	H.C.B-A2078 P354 7 PCS Dr. 1/2" TAMPER, TX-STAR BIT SOCKET KIT 7 PCS Dr. 1/2" 星型套筒組
H.C.B-A2056 P350 FLEXIBLE LED LIGHT LED 照明燈	H.C.B-A2081 P354 MULTIPLE WINDOW SCALE DIGITAL ADJUSTABLE TORQUE WRENCHES WITH LIGHT (Dr. 3/8") 3/8" 扭力扳手
H.C.B-A2061 P351 HEIGHTENED MANUAL HYDRAULIC PRESS (15 TONS) 加高型手動油壓床 (15 噸)	H.C.B-B2081 P355 3/8" DIGITAL TORQUE WRENCH W/ ANGLE HEAD (LENGTH: 400 mm) 3/8" 仰角式數位扭力扳手 (長度: 400 mm)
H.C.B-A2073 P351 14 PCS HEXAGON & TX-STAR SOCKET BIT KIT 14 PCS 6 角 & 星型套筒組	H.C.B-A2083 P355 RIGHT HAND CLICK TYPE TORQUE WRENCH (Dr. 1/4") 1/4" 扭力扳手
H.C.B-A2075 P351 44 PCS PROFESSIONAL TX-STAR BIT & BITS KIT 44 PCS 專業星型起子組	H.C.B-A2082 P355 MULTIPLE WINDOW SCALE DIGITAL ADJUSTABLE TORQUE WRENCHES WITH LIGHT (Dr. 1/2") 1/2" 扭力扳手
H.C.B-A2074 P351 40 PCS PROFESSIONAL QUALITY MECHANICS BIT KIT 40 PCS 專業級機械套筒組	H.C.B-B2082 P355 MULTIPLE WINDOW SCALE DIGITAL ADJUSTABLE TORQUE WRENCHES WITH LIGHT (Dr. 1/2") 1/2" 扭力扳手
H.C.B-A2059 P352 SIDE SLIP TESTER 雙輪定位側滑試驗機	H.C.B-C2082 P356 1/2" DIGITAL TORQUE WRENCH W/ ANGLE HEAD (LENGTH: 570 mm) 1/2" 仰角式數位扭力扳手 (長度: 570 mm)
H.C.B-B2059 P352 COMPLETE IC DESIGNED TOEIN & TOEOUT TESTING 數控式偏滑測試錶	H.C.B-A2086 P356 160 PCS COMPREHENSIVE TOOL KIT 160 PCS 專業級套筒組
H.C.B-A2059-1 P352 SINGLE SIDE SLIP TESTER 單輪定位側滑試驗機	H.C.B-A2103 P356 Dr. 1/2" MULTI-SPLINE BIT SOCKET KIT (26 PCS) 1/2" 12 角星型綜合套筒組 (26PCS)
H.C.B-C2059 P352 SINGLE SIDE SLIP TESTER 單輪定位側滑試驗機	H.C.B-A2104 P357 Dr. 1/2" HEXAGON BIT SOCKET KIT (30 PCS) 1/2" 6 角綜合套筒組 (30 PCS)
H.C.B-A2050 P353 CAST STEEL SWIVEL-BASE VISE (6") 老虎鉗 (6")	H.C.B-A2105 P357 Dr. 1/2" TX-STAR BIT SOCKET KIT (32 PCS) 1/2" 6 角星型綜合套筒組 (32 PCS)
H.C.B-B2050 P353 CAST IRON VISE (6") 老虎鉗 (6")	H.C.B-A2106 P357 Dr. 1/2" RIBE BIT SOCKET KIT (32 PCS) 1/2" 6 角綜合套筒組 (32 PCS)
H.C.B-A2050-1 P353 CAST STEEL SWIVEL-BASE VISE (8") 老虎鉗 (8")	H.C.B-C2195 P358 ANGLE ADJUSTABLE 30PCS LED WORKING LIGHTW/AC/DC RECHARGEABLE BATTERY LED 工作燈 (附磁鐵)
H.C.B-A2050-2 P353 CAST STEEL SWIVEL-BASE VISE (10") 老虎鉗 (10")	H.C.B-B2091 P358 110V WORK LIGHT (POWER SWITCH) 110V 工作燈 (附開關)
H.C.B-A2062 P353 3/8" IMPACT SOCKET KIT (VOLUTE) 渦型衝擊套筒	H.C.B-A2092 P358 12V WORK LIGHT 12V 工作燈
H.C.B-B2062 P353 TWIST SOCKET KIT (12 PCS) 螺旋式防脫套筒 (12 PCS)	New H.C.B-C2294 P358 LED POWER PACK LIGHT LED 行動電源工作燈
H.C.B-C2062 P353 TWIST SOCKET 3/4" 27,30,32,33,34,36MM +BAR 3/4" 外六角螺旋套筒 (7 PCS)	H.C.B-B2294 P359 LED WORK LIGHT LED 工作燈
H.C.B-A2076 P354 12 PCS DEEP STAR-E SOCKET KIT 12 PCS 長 E 型套筒組	H.C.B-A2107 P359 EXTRA LONG OFFSET BOX WRENCH KIT (8 PCS) 加長型梅花扳手組 (8 PCS)
H.C.B-A2077 P354 47 PCS BITS & SOCKET MULTI-TOOL KIT 47 PCS 起子、套筒複合工具組	



010
HWANG CHERNG BIN
 Speciality Tools Inc.

Index

New H.C.B-B2107 P359	H.C.B-A2162 P365
EXTRA LONG OFFSET BOX WRENCH KIT (6 PCS) (10 x 12 ,12 x 14, 13 x 15, 16 x 18, 17 x 19, 22 x 24 mm)	38 PCS SOCKET KIT
加長平型梅花扳手組 (6PCS) (10 x 12 ,12 x 14, 13 x 15, 16 x 18, 17 x 19, 22 x 24 mm)	38 PCS 套筒組
H.C.B-A2111 P359	H.C.B-A2153 P365
UNIVERSAL ADJUSTABLE FUEL TANK LID REMOVER / INSTALLER	UNDER HOIST STAND
可調式汽油箱蓋拆裝器	圓柱型支撐架 (腳踏型)
H.C.B-B2111 P360	H.C.B-A2163 P365
UNIVERSAL ADJUSTABLE FUEL TANK LID REMOVER / INSTALLER (IMPROVEMENT)	UNIVERSAL ENGINE BELT TENSION TESTER
可調式汽油箱蓋拆裝器	萬用引擎皮帶張力測試器
H.C.B-D2111 P360	H.C.B-A2165 P366
UNIVERSAL ADJUSTABLE FUEL TANK LID REMOVER / INSTALLER	HYDRAULIC BEARING PULLER (8 TONS)
可調式汽油箱蓋拆裝器	油壓式培林拔輪器 (8 噸)
H.C.B-A2144 P360	H.C.B-B2165 P366
LIFT SUPPORT FIXING CLAMP	HYDRAULIC BEARING PULLER (8 TONS)
升降桿固定器	油壓式培林拔輪器 (8 噸)
H.C.B-A2128 P360	H.C.B-C2165 P366
AIR HOSE REEL (10 METERS)	HYDRAULIC BEARING PULLER (12 TONS)
捲式風管 (10 米)	油壓式培林拔輪器 (12 噸)
H.C.B-B2128 P361	H.C.B-D2165 P366
CORD REEL	HYDRAULIC BEARING PULLERS (4 TONS)
捲式三插座	油壓式培林拔卸器 (4 噸)
H.C.B-C2128 P361	H.C.B-A2167 P366
CORD REEL + 110V WORK LIGHT	STAR-E SOCKET KIT (5 PCS) (Dr. 1/2", E10/E12/E14/E16/E18)
捲式三插座 + 日光燈 (110V)	E 型套筒組 (5 PCS) (Dr. 1/2", E10/E12/E14/E16/E18)
H.C.B-D2128 P361	H.C.B-A1296 P367
WATER HOSE REEL (8 METERS)	3 PCS BENT WRENCH
水管捲揚器 (8 米)	3 PCS 單頭彎柄梅花扳手
H.C.B-B2138 P362	H.C.B-A1298 P367
WORKING TABLE (CABINET)	FLEX SWIVEL GEARTECH WRENCH
美式工作桌 (加壁櫃)	正反轉搖頭棘輪扳手
H.C.B-B2138-1 P362	H.C.B-A2141 P367
FIXED HOOK	ELECTRIC CIRCUIT TESTER
壁櫃掛勾	供電型驗電筆
H.C.B-A2152 P362	H.C.B-A2176 P368
15 PCS CRAW FOOT WRENCH KIT	4 PCS DOUBLE WRENCH (E TYPE)
15 PCS 開口扳手	4 PCS 扳手 (E 型)
H.C.B-A2140 P362	H.C.B-A2177 P368
OIL FILTER CRUSHER	5 PCS HALF-MOON RING WRENCH
機油芯壓平機	5 PCS 扳手 (半月型)
H.C.B-A2142 P363	H.C.B-A2182 P368
BATTERY ANALYZER	COOLING SYSTEM VACUUM PURGE & REFILL KIT
電瓶電量診斷儀	真空式水箱水更換器
H.C.B-A2164 P363	H.C.B-A2190 P369
UNIVERSAL BATTERY TESTER	FINGER RATCHET (Dr. 1/4" & 1/4" Hex.)
多功能電瓶測試器	掌心雷棘輪 (Dr. 1/4" 頭 & 1/4" 孔)
H.C.B-A2145 P364	H.C.B-A2191 P369
94 PCS (Dr. 1/4" & 1/2") TOOL KIT	NOISE STETHOSCOPE
94 PCS (Dr. 1/4" & 1/2") 套筒組	異音聽診器
H.C.B-A2146 P364	H.C.B-A2169 P370
PNEUMATIC GREASE PUMP (20 L)	13 PCS T-HANDLE SOCKET WRENCH KIT
氣動黃油機 (20 升)	13 PCS T 桿套筒組
H.C.B-A2151 P364	H.C.B-A2196 P370
3/8" SPARK PLUG SOCKET KIT	AUTO COMPUTER MEMORY UNIT
3/8" 火星塞套筒組	電瓶繼電器
	H.C.B-A2203 P371
	PNEUMATIC FLUID EXTRACTOR (8.5 L)
	氣動抽油機 (8.5 L)



010
HWANG CHERNG BIN
 Specialty Tools Inc.

目錄索引
Index

Index

H.C.B-A2205 P371
 BASIC BRAKE OIL EXTRACTOR (2000 c.c.)
 專業剎車油吸取機 (2000 c.c.)

H.C.B-A2206 P371
 BRAKE OIL FILLER (1000 c.c.)
 剎車油補充油瓶 (1000 c.c.)

H.C.B-A2227 P372
 Dr. 1/2" TX-STAR UNIVERSAL BIT SOCKET KIT (8 PCS) (T30/T40/T45/T50/T55/T60/T70)
 Dr. 1/2" 六角星型通用套筒組 (8 PCS) (T30/T40/T45/T50/T55/T60/T70)

H.C.B-B2227 P372
 Dr. 1/2" XZN (SPLINE) UNIVERSAL BIT SOCKET KIT (8 PCS) (M5/M6/M8/M10/M12/M14/M16/1/2"ADAPTER)
 Dr. 1/2" 十二角型通用套筒組 (8 PCS) (M5/M6/M8/M10/M12/M14/M16/1/2"ADAPTER)

H.C.B-C2227 P372
 Dr. 1/2" RIBE UNIVERSAL BIT SOCKET KIT (8 PCS) (M6/M7/M8/M9/M10/M12/M14 & 1/2" ADAPTER)
 Dr. 1/2" 六角齒輪型通用套筒組 (8 PCS) (M6/M7/M8/M9/M10/M12/M14 & 1/2" ADAPTER)

H.C.B-A2229 P372
 Dr. 1/2" DEEP STAR-E IMPACT SOCKET KIT (9 PCS) (78 mm) (E10/E11/E12/E14/E16/E18/E20/E22/E24)
 Dr. 1/2" 星形長套筒組 (9 PCS) (78 mm) (E10/E11/E12/E14/E16/E18/E20/E22/E24)

H.C.B-A1426 P373
 TOYOTA-SUBARU-DAIHATSU OIL FILTER WRENCH (Dr. 1/2", 14 POINTS, 65.5 mm)
 TOYOTA-SUBARU-DAIHATSU 機油芯扳手 (Dr. 1/2", 14 角, 65.5 mm)

H.C.B-B2167 P373
 STAR-E SOCKET KIT (6 PCS) (Dr. 1/2", E10/E12/E14/E16/E18/E20)
 E 型套筒組 (6 PCS) (Dr. 1/2", E10/E12/E14/E16/E18/E20)

H.C.B-A2230 P373
 Dr. 3/4" TX-STAR & SPLINE IMPACT BIT SOCKET KIT (6 PCS) (61 mm) (T70/T80/90/T100/M16/M18)
 Dr. 3/4" 氣動星形 12 角凸型套筒組 (6 PCS) (61 mm) (T70/T80/T90/T100/M16/M18)

H.C.B-B2230 P373
 3/4" SQ. DRIVE HEXAGON & SPLINE IMPACT BIT SOCKET KIT (9 PCS) (61 mm) (14/17/19/21/22/23/24 mm/M16/M18)
 Dr. 3/4" 氣動六角&12 角套筒組 (9 PCS) (61mm) (14/17/19/21/22/23/24 mm/M16/M18)

H.C.B-C2230 P374
 3/4" SQ. DRIVE HEXAGON & TX-STAR IMPACT BIT SOCKET KIT (9 PCS) (61 mm) (19/ 21/ 22/ 23/ 24 mm/ T70/ 80/ 90/ 100)
 Dr. 3/4" 氣動星形12 角凸型套筒組 (9 PCS) (61 mm) (19/21/22/23/24 mm/T70/80/90/100)

H.C.B-A2236 P374
 7 PCS GLOW PLUG SOCKET KIT (with 3" EXTENBAR)
 7 PCS 預熱塞火星塞套筒組 (含3" 接桿)

H.C.B-B2235 P374
 AUTOMATIC TRANSMISSION OIL FILLING KIT (12.5L)
 通用變速箱補充瓶 (12.5 公升)

H.C.B-C2235 P375
 AUTOMATIC TRANSMISSION OIL FILLING KIT (7.5 L) (14 PCS)
 通用變速箱補充瓶 (7.5 公升) (14 PCS)

H.C.B-A2235 P375
 AUTOMATIC TRANSMISSION OIL FILLING KIT (7.5 L)
 通用變速箱補充瓶 (7.5 公升)

H.C.B-A2253 P376
 BEARING SEPARATOR (20~150 mm)
 培林拆卸器 (20~150 mm)

New **H.C.B-A1655** P376
 UNIVERSAL BEARING EXTRACTOR
 萬用培林拆卸器

H.C.B-A2254 P376
 9.75" PROFESSIONAL CRIMPING TOOL
 9.75" 撥線鉗

H.C.B-A2257 P377
 FUEL GAUGE & PUMP SENDER COLLAR WRENCH
 燃油壓力錶 & 泵浦油箱蓋扳手

H.C.B-A1502 P377
 20 TON AIR / HYDRAULIC FLOOR JACK-LOW PROFILE
 20 TON 氣動 / 油壓千斤頂 (超低型)

H.C.B-B1502 P378
 20 TON AIR / HYDRAULIC TRUCK JACK-LOW TYPE
 20 TON 氣動 / 油壓千斤頂

H.C.B-C1502 P378
 50 TON AIR / HYDRAULIC JACK
 50 TON 氣動 / 油壓千斤頂

H.C.B-C1051 P379
 TOOL CABINET
 壁櫃

H.C.B-A6005-5 P380
 TOOL HOLDER (5 SLICES)
 工具櫃 (5 片)

H.C.B-A2265 P380
 PORTABLE MINI FLOOR JACK
 輕便型油壓剪式千斤頂

H.C.B-A2258 P381
 TOE JACK
 L 型油壓千斤頂

H.C.B-A1541 P382
 DIGITAL CALIPER
 極速卡尺

H.C.B-A2283 P382
 Dr. 1/2" DEEP IMPACT SOCKET KIT (13 PCS) (10/11/12/13/14/16/17/19/21/22/24/27/30 mm)
 Dr. 1/2" 長型氣動套筒組 (13 PCS) (10/11/12/13/14/16/17/19/21/22/24/27/30 mm)

New **H.C.B-B2299** P382
 3 FUNCTION TIRE PRESSURE GAUGE (FOR CAR)
 三用胎壓量錶 (小車)

New **H.C.B-A2306** P383
 Dr. 3/4" TORQUE WRENCH (200-1000 N.M)
 Dr. 3/4" 扭力扳手 (200-1000 牛頓米)

New **H.C.B-A2316** P383
 MECHANICS CREEPER
 臥板



010
HWANG CHERNG BIN
 Speciality Tools Inc.

SINCE 1990

PANEL REPAIR TOOL
鉸金修護工具 (P385~404)

H.C.B-A1011	P385	H.C.B-E3036	P389
SPOT WELDING SLIDE HAMMER KIT		AIR / HYDRAULIC FOOT PUMP (2000 c.c.) (WITHOUT HOSE)	
自動點焊滑鎚		氣動 / 油壓幫浦 (2000 c.c.) (不含管)	
H.C.B-A1012	P385	H.C.B-F3036	P389
WASHER SLIDE HAMMER KIT		AIR/HYDRAULIC PUMP (WITHOUT HOSE) 6.2-6.8 BAR AIR PRESSURE / PUMP 230 - 245 BAR	
點焊滑鎚		氣動 / 油壓幫浦 (不含管) 6.2-6.8 BAR AIR PRESSURE / PUMP 230-245 BAR	
H.C.B-A1032	P385	H.C.B-A3004	P389
PANEL SLIDE HAMMER		4 TONS PANEL REPAIR KIT	
車體鉸金滑鎚		4 噸鉸金組	
H.C.B-A3018	P385	H.C.B-A3005	P390
SPOT WELDING SLIDE HAMMER KIT MINI MODEL		10 TONS TWO SPEEDS DYNAMIC POWER KIT	
自動點焊滑鎚袖珍型		10 噸雙段油壓鉸金組	
H.C.B-A3019	P385	H.C.B-A3006	P390
SPOT WELDING SLIDE HAMMER KIT MINI MODEL		EXTRA LARGE BODY SHEET SLIDE HAMMER KIT	
自動點焊滑鎚袖珍型		鉸金滑鎚組 (5 件鋼製爪把)	
H.C.B-A1013	P386	H.C.B-A3014	P390
EXTENSION BAR		10 TONS HYDRAULIC CYLINDER (SPHERE)	
10 噸接杆組		10 噸球型壓桿組	
H.C.B-A1014	P386	H.C.B-A3015	P390
ADJUSTABLE EXTENSION BAR		10 TONS MINI HYDRAULIC CYLINDER	
調整型接杆		10 噸迷你油壓缸	
H.C.B-A3003	P386	H.C.B-A3020	P391
SPOT WELDER		4 TONS CYLINDER	
自動點焊機		4 噸迷你油壓缸	
H.C.B-A3016	P386	H.C.B-A3008	P391
AIR SPOT DRILL		PULL RAMS (5 TONS)	
點焊氣鑽 (直型)		5 噸油壓倒拉千斤頂	
H.C.B-A3017	P386	H.C.B-A3021	P391
AIR SPOT DRILL		10 TONS PULL RAMS	
點焊鑽除機		10 噸倒拉缸	
H.C.B-A3001	P387	H.C.B-A3007	P391
10 TONS POWER PULLER PACKAGE		PULL HOOK KIT	
10 噸鉸金拉柱組		深拉鉤組	
H.C.B-B3001	P387	H.C.B-A3009	P392
10 TONS POWER PULLER PACKAGE		DOWN PULLY ASSEMBLY	
10 噸鉸金拉柱組		底盤拉鉤	
H.C.B-A3002	P387	H.C.B-A3010	P392
SIMPLER AND EASIER PANEL FRAME		10 TONS CHAIN FIXING BASE	
簡易式鉸金拉柱		鏈條錨座 (八卦台用)	
H.C.B-A3036	P388	H.C.B-A3011	P392
AIR HYDRAULIC PUMP (1600 c.c.) (Dr. 3/8" ADAPTOR)		3 TONS SCISSOR CLAMP	
氣動幫浦 (1600 c.c.) (Dr. 3/8" 接頭)		剪型拉夾鉗	
H.C.B-B3036	P388	H.C.B-A3012	P392
AIR HYDRAULIC PUMP (1800 c.c.)		AIR SAW	
氣動幫浦 (1800 c.c.)		氣動鋸	
H.C.B-C3036	P388	H.C.B-B3012	P393
DOUBLE HOSE AIR HYDRAULIC PUMP (3800 c.c.)		AIR SAW	
雙管幫浦 (3800 c.c.)		氣動鋸	
H.C.B-D3036	P388	H.C.B-A3012-1	P393
AIR / HYDRAULIC PUMP (7600 c.c.)		AIR SAW BLADE	
氣動 / 油壓幫浦 (7600 c.c.)		氣動鋸片	
		H.C.B-A3022	P393
		THE SYSTEM OF BODY REPAIR EQUIPMENT (FOR ONE CAR)	
		鉸金八卦台 (一台份)	
		H.C.B-A3023	P393
		THE SYSTEM OF BODY REPAIR EQUIPMENT (FOR TWO CARS)	
		鉸金八卦台 (二台份)	



010

HWANG CHERNG BIN
Specialty Tools Inc.

目錄索引
Index

Index

H.C.B-A3031 P394
CLAMP ANCHOR BASE
油壓桿撐頭

H.C.B-A3032 P394
BALL PIVOT
油壓桿支轉頭

H.C.B-A3033 P394
BALL PIVOT BASE
支轉頭錨座

H.C.B-A3029 P394
ADJUSTABLE EXTENSION BAR
調整型接桿

H.C.B-A3030 P395
ADJUSTABLE EXTENSION BAR
調整型接桿

H.C.B-A3034 P395
STAND AUTO WELDER
自動送料電焊機

H.C.B-A3035 P395
PORTABLE AUTO WELDER
迷你型氩金機

H.C.B-A3037-A P396
ARCH ANCHOR BASE
弧度錨頭

H.C.B-A3037-B P396
ANGLE ANCHOR BASE
角度錨頭

H.C.B-A3038 P396
UNIVERSAL BASE FRAME CLAMP KIT
萬能車底固定夾具組

H.C.B-A3039 P396
HYDRAULIC PLIERS
油壓撐開鉗

H.C.B-A3024 P397
SMALL MOUTH PULL CLAMP (5 TONS)
窄型張引夾 (5 噸)

H.C.B-A3025 P397
SMALL MOUTH PULL CLAMP (TWO-WAY)
窄型張引夾 (雙向)

H.C.B-A3026 P397
BOX CLAMP (3 TONS)
寬型張引夾 (大小邊、3 噸)

H.C.B-A3027 P397
LONG NOSE CLAMP (2 TONS)
扁嘴型張引夾 (2 噸)

H.C.B-A3028 P398
MINI CLAMP (TWO-WAY)
迷你型張引夾 (雙向)

H.C.B-A3042 P398
FRAME RACK CLAMP (5 TONS)
寬齒型張引夾 (5 噸)

H.C.B-A3043 P398
BOX CLAMP (TWO-WAY)
寬型張引夾 (雙向)

H.C.B-A3040 P398
STRUT PULLER KIT
避震器座拉引器

H.C.B-A3041 P399
ANCHOR POT
地雷 (八卦台)

H.C.B-A3044 P399
FRAME RACK CLAMP (MULTI-WAY)
寬齒型張引夾 (多方向)

H.C.B-A3045 P399
FRAME RACK CLAMP (TWO-WAY)
寬齒型張引夾 (雙向)

H.C.B-A3046 P399
HEAVY DUTY CLAMP
重型張引夾

H.C.B-A3047 P400
CHAIN JOINT (DOUBLE GAP HOOKS)
雙勾型鍊條連接器 (間隙式)

H.C.B-A3048 P400
CHAIN JOINT
鍊條轉換器

H.C.B-A3049 P400
HANDY LINK
扁型鍊條連接器

H.C.B-A3050 P400
CHAIN HANDY HOOK
手掌型拉鉤

H.C.B-A3051 P401
3" C TYPE CLAMP
3" C 型張引夾

H.C.B-A3052 P401
6" C TYPE CLAMP
6" C 型張引夾

H.C.B-A3013 P401
3 TONS MULTI-HOLE PULL PLATES
拖拉板

H.C.B-A3053 P401
LATERAL PULL PLATE
橫向拖拉板

H.C.B-A3054 P402
UNIBODY CLAMP
車板夾

H.C.B-A3055 P402
CHAIN JOINT (DOUBLE GRAB HOOKS)
雙勾型鍊條連接器 (掛勾式)

H.C.B-A3056 P402
CHAIN JOINT (GAP & GRAB HOOKS ASSEMBLY)
雙勾型鍊條連接器 (掛勾 & 間隙勾)

H.C.B-A3057 P402
TIGHT OPENING CLAMP (3 TONS)
立式張引夾 (3 TONS)

H.C.B-A3058 P402
CORNER CLAMP
張引夾

H.C.B-A3059 P403
CORNER CLAMP
張引夾

New H.C.B-A3060 P403
CLEVIS SHORTENING CLUTCH (2 TONS)
U 型夾短掛勾 (2 噸)



010
HWANG CHERNG BIN
 Speciality Tools Inc.

SINCE 1990

Index

New H.C.B-B3060	P403	H.C.B-A5010	P408
CLEVIS SHORTENING CLUTCH (3.15 TONS)		A/C COMPRESSOR CLUTCH REMOVER (DOUBLE HEAD THREADS)	
U 型夾短掛勾 (3.15 噸)		壓縮機離合器拆卸器 (雙頭牙)	
New H.C.B-A3061	P404	H.C.B-A5011	P409
DOOR FRAME PULLER (810-1000 mm)		A/C SPRING DISCONNECT TOOLS FOR TOYOTA	
車身門框撐開器 (810-1000 mm)		TOYOTA 冷氣管路拆卸器	
New H.C.B-B3061	P404	H.C.B-B5011	P409
DOOR FRAME PULLER (1080-1600 mm)		A/C SPRING LOCK COUPLING TOOLS FOR TOYOTA	
車身門框撐開器 (1080-1600 mm)		TOYOTA 冷氣管固定夾	
		H.C.B-A5012	P409
		UNIVERSAL VALVE CORE REMOVAL/INSTALLATION TOOL KIT	
		冷煤氣嘴拆裝工具組	
		H.C.B-A5013	P409
		UNIVERSAL FLARING TOOL	
		銅管擴張器	

AIR CONDITIONING REPAIR TOOL

冷氣修護工具 (P406~409)

H.C.B-A5001	P406		
R-12 MANIFOLD GAUGE KIT			
R-12 冷媒高低壓量錶組 (台製) (5 尺)			
H.C.B-A5002	P406		
R134A MANIFOLD GAUGE KIT			
R-134A 冷媒高低壓量錶組			
H.C.B-A5003	P406		
AUTO A/C SWIVEL ADAPTERS KIT			
冷媒快速接頭			
H.C.B-A5004	P406		
R134A LOW & HIGH PRESSURE QUICK COUPLING			
冷媒高低壓快拆接頭 R134A 用 (附接頭)			
H.C.B-A5005-EA	P407		
A/C TESTING TOOL KIT (EUROPEAN & AMERICAN)			
冷氣測漏工具組 (歐美系)			
H.C.B-A5005-JP	P407		
A/C TESTING TOOL KIT (JAPANESE)			
冷氣測漏工具組 (日系綜合)			
H.C.B-A5005-GE	P407		
A/C TESTING TOOL KIT (GENERAL)			
冷氣測漏工具組 (一般)			
H.C.B-A5006	P407		
FLARING TOOL			
銅管擴張器			
H.C.B-A5008	P408		
COMPRESSOR BEARING EXTRACTION/ INSTALLATION TOOL KIT			
壓縮機培林拆裝組			
H.C.B-A5007	P408		
CHARGING CYLINDER			
冷煤定量筒			
H.C.B-A5009	P408		
VACUUM PUMP			
冷媒真空幫浦 (推車型)			

MACHINERY & HARDWARE

機械五金類 (P411~412)

H.C.B-A6001	P411
HYDRAULIC ELEVATOR CART (300 KGS)	
油壓升降推車 (300 KGS)	
H.C.B-A6002	P411
ELECTRIC CABLE RACK (HYDRAULIC)	
電纜放線架 (油壓式)	
H.C.B-A6004	P411
DISPLAY SHELF (L: 945 W: 490 H: 2100 mm)	
展示架 (L: 945 mm W: 490 mm H: 2100 mm)	
H.C.B-A6003	P411
MOTORCYCLE LIFT	
機車頂車機	
H.C.B-A8001	P412
MULTI-FUNCTION PNEUMATIC/HYDRAULIC ENGINE LIFT PAT.M 430377	
多功能剪型氣 / 油壓引擎拆卸設備	



010
HWANG CHERNG BIN
 Specialty Tools Inc.

目錄索引
Index

Index

AIR POWER TOOL
氣動工具 (P414~417)

H.C.B-A2005 P414
 1/2" AIR IMPACT WRENCH
 1/2" 氣動扳手 (下排式)

H.C.B-A2005-1 P414
 1/2" AIR IMPACT WRENCH (WITH 10PCS SOCKET)
 1/2" 氣動扳手 (下排式, 套筒)

H.C.B-B2025 P414
 3/8" AIR MINI RATCHET WRENCH
 3/8" 氣動棘輪扳手

H.C.B-A2034 P415
 1/4" 90° AIR STUBBY AIR RATCHET WRENCH
 1/4" 90° 氣動扳手

H.C.B-A2046 P415
 1/2" 90° STUBBY AIR RATCHET WRENCH
 1/2" 90° 氣動扳手

H.C.B-A2047 P415
 AIR DIE GRINDER
 氣動刻模機

H.C.B-A2048 P415
 16 PCS AIR DIE GRINDER KIT
 氣動刻模機組 (16 PCS)

H.C.B-A2139 P415
 1/2" MINI IMPACT WRENCH
 1/2" 輕型氣動扳手

H.C.B-A2173 P416
 1/2" 90° AIR RATCHET WRENCH
 1/2" 90° 氣動棘輪扳手

H.C.B-A2200 P416
 3/4" IMPACT WRENCH
 3/4" 氣動扳手

H.C.B-A2285 P416
 1/2" MINI COMPOSITE IMPACT WRENCH (JAMBO HAMMER)
 4 分塑膠手柄迷你單環捶打式衝擊扳手

H.C.B-A2286 P416
 1/2" COMPOSITE IMPACT WRENCH (TWIN HAMMER)
 4 分塑膠手柄雙環捶打式衝擊扳手

H.C.B-B2286 P417
 3/8" COMPOSITE IMPACT WRENCH (TWIN HAMMER) 475 NM
 3 分塑膠手柄雙環捶打式衝擊扳手 (扭力 475 牛頓米)



H.C.B-A2287 P417
 3/4" COMPOSITE IMPACT WRENCH (TWIN HAMMER)
 6 分塑膠手柄雙環捶打式衝擊扳手

New H.C.B-B2200 P417
 3/4" ALUMINUM HOUSING IMPACT WRENCH
 3/4" 鋁合金氣動扳手



010
HWANG CHERNG BIN
 Specialty Tools Inc.

Index

H.C.B-A1001 P002	H.C.B-A1021 P091	H.C.B-A1027-02 P057
H.C.B-A1002 P002	H.C.B-B1021 P091	H.C.B-A1027-03 P057
H.C.B-A1003 P004	H.C.B-C1021 P092	H.C.B-A1027-04 P057
H.C.B-A1004 P064	H.C.B-D1021 P092	H.C.B-A1027-05 P057
H.C.B-A1005 P242	H.C.B-E1021 P092	H.C.B-A1028 P033
H.C.B-A1006 P242	H.C.B-F1021 P092	H.C.B-A1029 P058
H.C.B-A1007 P242	H.C.B-G1021 P092	H.C.B-A1030 P007
H.C.B-A1007-8-6 P242	H.C.B-A1022 P028	H.C.B-A1031 P135
H.C.B-A1008-1 P002	H.C.B-A1022(A) P029	H.C.B-A1032 P385
 H.C.B-B1008 P003	H.C.B-A1022(B) P029	H.C.B-A1033 P089
H.C.B-A1009 P329	H.C.B-A1022(C) P029	H.C.B-A1034 P064
H.C.B-A1010 P129	H.C.B-A1022(D) P029	H.C.B-A1035 P058
H.C.B-B1010 P329	H.C.B-A1022(E) P030	H.C.B-A1035-1 P058
H.C.B-C1010 P329	H.C.B-A1022(F) P030	H.C.B-A1035-2 P058
H.C.B-A1011 P385	H.C.B-A1022(G) P030	H.C.B-A1035-3 P058
H.C.B-A1012 P385	H.C.B-A1022(H) P030	H.C.B-A1036 P007
H.C.B-A1013 P386	 H.C.B-A1022(I) P031	H.C.B-A1037 P058
H.C.B-A1014 P386	H.C.B-B1022 P335	H.C.B-A1038 P064
H.C.B-A1015 P330	H.C.B-A1023 P005	H.C.B-A1039 P027
H.C.B-A1016 P027	H.C.B-A1024 P006	H.C.B-B1040 P007
H.C.B-A1017 P027	H.C.B-A1025 P006	H.C.B-A1041 P135
H.C.B-A1018 P004	H.C.B-A1026 P244	H.C.B-A1042 P059
H.C.B-A1019 P088	H.C.B-A1027-01 P057	H.C.B-A1042-1 P059
H.C.B-A1020 P088	02-03-04-05 P057	H.C.B-A1042-3 P059
H.C.B-M62 P091	H.C.B-A1027-01 P057	



010

HWANG CHERNG BIN
Specialty Tools Inc.

目錄索引
Index

Index

H.C.B-A1043	P008	H.C.B-A1054-4	P284	H.C.B-G1074	P035
H.C.B-A1044	P008	H.C.B-A1055	P143	H.C.B-P1074	P035
H.C.B-A1044-1	P008	H.C.B-A1056	P244	H.C.B-T1074	P035
H.C.B-A1044-2	P070	H.C.B-A1057	P245	H.C.B-C1076	P337
H.C.B-A1045	P143	H.C.B-A1058	P031	H.C.B-A1078	P143
H.C.B-A1046	P135	H.C.B-A1059	P008	H.C.B-A1079-1	P197
H.C.B-A1047	P065	H.C.B-B1059	P008	H.C.B-A1079-2	P197
H.C.B-A1047-1	P066	H.C.B-A1060	P243	H.C.B-A1079-3	P197
H.C.B-A1047-2	P066	H.C.B-A1062	P205	H.C.B-A1080	P144
H.C.B-A1047-F&G	P066	H.C.B-A1063	P205	H.C.B-A1081	P271
H.C.B-A1047-H	P066	H.C.B-A1064	P059	H.C.B-A1082	P009
H.C.B-B1047	P065	H.C.B-A1065	P336	H.C.B-A1082-1	P009
H.C.B-C1047	P007	H.C.B-A1067	P036	H.C.B-A1083	P010
H.C.B-A1048	P080	H.C.B-A1068	P009	H.C.B-A1084	P245
H.C.B-A1049	P272	H.C.B-A1069	P237	H.C.B-A1085	P130
H.C.B-A1051-1	P335	H.C.B-A1070	P068	H.C.B-A1085-7	P130
H.C.B-A1051-2	P335	H.C.B-A1072	P038	H.C.B-A1086	P246
H.C.B-A1051-3	P336	H.C.B-A1073	P337	H.C.B-A1086-1	P246
H.C.B-A1051-4	P336	H.C.B-A1074	P034	H.C.B-A1086-3	P247
H.C.B-C1051	P379	H.C.B-A1074-1	P034	H.C.B-A1086-4	P247
H.C.B-A1052	P223	H.C.B-A1074-2	P034	H.C.B-A1087	P067
H.C.B-A1052-9	P223	H.C.B-A1074-3	P035	H.C.B-B1087	P067
H.C.B-A1053	P143	H.C.B-A1074-4	P035	H.C.B-C1087	P067
H.C.B-A1054-2	P284	H.C.B-B1074	P035	H.C.B-A1088	P093
H.C.B-A1054-3	P153	H.C.B-C1074	P035	H.C.B-A1089	P068



010

HWANG CHERNG BIN
Specialty Tools Inc.

Index

H.C.B-A1092	P010	H.C.B-A1107	P136	H.C.B-B1117	P341
H.C.B-A1093	P197	H.C.B-B1107	P136	H.C.B-B1117-1	P341
H.C.B-B1093	P198	H.C.B-A1108	P146	H.C.B-A1118	P093
H.C.B-A1094	P059	H.C.B-A1109	P040	H.C.B-A1119	P016
H.C.B-A1095-4H	P247	H.C.B-A1110	P040	H.C.B-A1119-8	P016
H.C.B-A1095-5H	P247	H.C.B-A1111	P012	H.C.B-M52TU	P088
H.C.B-B1095-4H	P068	H.C.B-B1111	P012	H.C.B-A1121	P089
H.C.B-B1095-5H	P068	H.C.B-C1111	P012	H.C.B-A1121-1	P090
H.C.B-C1095-5H	P069	H.C.B-A1113	P010	H.C.B-A1121-2	P090
H.C.B-D1095	P069	H.C.B-A1115	P282	H.C.B-A1121-3	P090
H.C.B-A1096	P249	H.C.B-A1116-36H	P250	H.C.B-A1121-4	P090
H.C.B-A1097	P285	H.C.B-A1116-38H	P251	H.C.B-A1121-5	P090
H.C.B-A1097-5	P329	H.C.B-A1116-40H	P251	H.C.B-A1121-6	P090
H.C.B-A1098	P290	H.C.B-A1117	P342	H.C.B-B1121	P089
H.C.B-A1099	P031	H.C.B-A1117-1	P342	H.C.B-A1123	P005
H.C.B-B1099	P031	H.C.B-A1117-2	P342	H.C.B-A1124	P336
H.C.B-A1100	P129	H.C.B-A1117-3	P342	H.C.B-A1128	P042
H.C.B-A1101	P129	H.C.B-A1117-4	P343	H.C.B-A1129	P086
H.C.B-A1103	P036	H.C.B-A1117-4-1	P343	H.C.B-B1129	P086
H.C.B-A1105	P144	H.C.B-A1117-4-2	P343	H.C.B-D1129	P085
H.C.B-A1105-4	P145	H.C.B-A1117-4-3	P343	H.C.B-E1129	P190
H.C.B-A1105-5	P145	H.C.B-A1117-5	P344	 H.C.B-F1129	P085
H.C.B-A1105-6	P145	H.C.B-A1117-5-1	P344	H.C.B-A1130	P094
H.C.B-A1105-7	P145	H.C.B-A1117-5-2	P344	H.C.B-A1131	P038
H.C.B-A1106	P043	 H.C.B-A1117-6	P344	H.C.B-A1132	P069



010
HWANG CHERNG BIN
Specialty Tools Inc.

目錄索引
Index

Index

H.C.B-A1133	P098	H.C.B-A1147 & A1148	P016	H.C.B-C1159	P045
H.C.B-A1134	P198	H.C.B-A1149	P198	New H.C.B-D1159	P044
H.C.B-A1135-R	P337	H.C.B-A1150	P136	H.C.B-A1160	P146
H.C.B-N62&N73	P094	H.C.B-A1151	P199	H.C.B-A1161	P144
H.C.B-A1136	P094	H.C.B-A1152	P199	H.C.B-A1162	P146
H.C.B-A1136-5	P095	H.C.B-A1153	P069	H.C.B-A1163	P251
H.C.B-A1136-6	P095	H.C.B-A1154	P072	H.C.B-A1164	P147
H.C.B-A1136-7	P095	H.C.B-A1155	P017	H.C.B-A1166	P293
H.C.B-A1136-8	P095	H.C.B-A1156	P099	H.C.B-A1167	P043
H.C.B-A1136-9	P095	H.C.B-A1156-5	P100	H.C.B-B1167	P289
H.C.B-A1136-10	P095	H.C.B-A1156-6	P100	H.C.B-A1168	P018
H.C.B-A1136-11	P096	H.C.B-A1156-7	P100	H.C.B-B1168	P018
H.C.B-B1136	P094	H.C.B-A1156-8	P100	H.C.B-C1168	P064
H.C.B-C1136	P096	H.C.B-A1156-9	P100	H.C.B-D1168	P019
H.C.B-A1137	P088	H.C.B-A1156-10	P101	H.C.B-E1168	P018
H.C.B-A1138	P098	H.C.B-A1156-11	P101	H.C.B-F1168	P264
H.C.B-A1140	P016	H.C.B-A1156-12	P101	New H.C.B-G1168	P214
H.C.B-A1141	P039	H.C.B-B1156	P101	H.C.B-A1173	P253
H.C.B-A1142	P292	H.C.B-C1156	P102	H.C.B-A1174	P017
H.C.B-A1143	P282	H.C.B-A1157	P284	H.C.B-A1177	P253
H.C.B-B1143	P282	H.C.B-A1157-1	P284	H.C.B-A1185	P074
H.C.B-A1144	P043	H.C.B-A1157-2	P284	H.C.B-A1188-1	P102
H.C.B-A1145	P041	H.C.B-A1157-3	P284	H.C.B-A1188-2	P102
H.C.B-B1145	P042	H.C.B-A1158	P073	H.C.B-A1188-3	P102
H.C.B-A1146	P060			H.C.B-A1188-4	P103



010

HWANG CHERNG BIN
Specialty Tools Inc.

Index

H.C.B-A1188& A1188-3	P102	H.C.B-B1198	P113	H.C.B-M1207	P219
H.C.B-B1188	P103	H.C.B-C1198	P113	H.C.B-A1208	P060
H.C.B-C1188	P108	H.C.B-D1198	P113	H.C.B-A1209	P061
H.C.B-E1188	P107	H.C.B-E1198	P114	H.C.B-B1209	P062
H.C.B-F1188	P108	H.C.B-A1199	P032	H.C.B-A1211	P075
H.C.B-G1188	P105	H.C.B-B1199	P032	H.C.B-B1211	P075
H.C.B-G1188-1 & 6	P105	H.C.B-C1199	P031	H.C.B-A1212	P148
H.C.B-G1188-2 & 5	P105	H.C.B-A1200..... P147		H.C.B-A1213	P148
H.C.B-G1188-3	P105	H.C.B-A1201	P074	H.C.B-A1214	P148
H.C.B-H1188	P103	H.C.B-B1201	P073	H.C.B-A1215	P148
H.C.B-I1188	P103	H.C.B-A1202	P200	H.C.B-B1215	P149
H.C.B-A1189	P281	H.C.B-A1204	P098	H.C.B-A1216	P072
H.C.B-A1191	P253	H.C.B-A1205	P145	H.C.B-A1217	P149
H.C.B-A1192	P254	H.C.B-A1206	P072	H.C.B-A1218	P149
H.C.B-B1192	P254	H.C.B-A1207	P216	H.C.B-A1219	P149
H.C.B-A1193	P292	H.C.B-B1207	P216	H.C.B-A1220	P156
H.C.B-A1194	P253	H.C.B-C1207	P216	H.C.B-B1220	P156
H.C.B-A1195	P147	H.C.B-D1207	P217	H.C.B-C1220	P156
H.C.B-B1195	P147	H.C.B-F1207	P217	H.C.B-A1223	P289
H.C.B-A1196	P135	H.C.B-G1207	P217	H.C.B-B1223	P289
H.C.B-A1197	P199	H.C.B-H1207	P218	H.C.B-C1223	P289
H.C.B-B1197	P200	H.C.B-I1207	P218	H.C.B-D1223	P290
H.C.B-A1198	P112	H.C.B-J1207	P218	H.C.B-E1223	P290
		H.C.B-K1207	P218	H.C.B-A1224	P119
		H.C.B-L1207	P218	H.C.B-A1230	P151



010
HWANG CHERNG BIN
Specialty Tools Inc.

目錄索引
Index

Index

H.C.B-A1231	P150	H.C.B-A1253	P079	H.C.B-A1285	P200
H.C.B-B1231	P150	H.C.B-B1253	P080	H.C.B-A1288	P119
H.C.B-A1232	P150	H.C.B-C1253	P080	H.C.B-A1289	P051
H.C.B-B1232	P150	H.C.B-D1253	P080	H.C.B-A1290	P061
H.C.B-A1233	P150	H.C.B-A1254	P254	H.C.B-A1291	P047
H.C.B-B1233	P151	H.C.B-A1255	P049	H.C.B-A1292	P121
H.C.B-A1234	P151	H.C.B-B1255	P049	H.C.B-B1292	P121
H.C.B-B1234	P151	H.C.B-D1255	P050	H.C.B-C1293	P052
H.C.B-A1235	P152	H.C.B-A1258	P076	H.C.B-B1294	P081
H.C.B-B1235	P152	H.C.B-B1258	P076	H.C.B-A1295	P154
H.C.B-C1235	P152	H.C.B-C1258	P077	H.C.B-A1296	P367
H.C.B-A1240	P028	H.C.B-A1259	P017	H.C.B-A1297	P306
H.C.B-A1241	P036	H.C.B-A1260	P032	H.C.B-A1298	P367
H.C.B-A1243	P038	H.C.B-A1262	P115	H.C.B-A1299	P052
H.C.B-B1243	P039	H.C.B-B1262	P116	H.C.B-B1299	P052
H.C.B-A1245	P091	H.C.B-C1262	P116	H.C.B-A1300..... P118	
H.C.B-A1249	P041	H.C.B-B1264	P081	H.C.B-B1300	P118
H.C.B-S85	P111	H.C.B-C1264	P071	H.C.B-C1300	P118
H.C.B-A1250	P111	H.C.B-A1266	P033	H.C.B-A1301	P123
H.C.B-B1250	P111	H.C.B-A1267	P034	H.C.B-B1301	P124
H.C.B-C1250	P111	H.C.B-A1268	P033	H.C.B-A1302	P121
H.C.B-D1250	P112	H.C.B-A1272	P295	H.C.B-A1303	P054
H.C.B-E1250	P112	H.C.B-A1272	P295	H.C.B-A1304	P083
H.C.B-A1251	P042	H.C.B-B1272	P296	H.C.B-A1305	P047
H.C.B-B1251	P042	H.C.B-A1276	P157	H.C.B-A1306	P237



010

HWANG CHERNG BIN
Specialty Tools Inc.

Index

H.C.B-A1307 P159
 H.C.B-A1308 P237
 H.C.B-A1309 P120
 H.C.B-A1310-14 P309
 H.C.B-A1310-17 P309
 H.C.B-A1311 P121
 H.C.B-B1311 P121
 H.C.B-A1312 P205
 H.C.B-A1313 P054
 H.C.B-A1315 P201
 H.C.B-B1315 P201
 H.C.B-A1316 P122
 H.C.B-A1317 P120
 H.C.B-B1317 P120
 H.C.B-A1318 P019
 H.C.B-A1321 P159
 H.C.B-A1322 P159
 H.C.B-A1323 P160
 H.C.B-A1324 P160
 H.C.B-A1325 P160
 H.C.B-A1326 P032
 H.C.B-B1326 P033
 H.C.B-C1327 P044
 H.C.B-A1330 P047
 H.C.B-A1331 P097
 H.C.B-A1332 P082

H.C.B-B1332 P082
 H.C.B-C1332 P082
 H.C.B-D1332 P082
 H.C.B-A1333 P062
 H.C.B-A1334 P047
 H.C.B-A1340 P122
 H.C.B-A1341 P013
 H.C.B-A1342 P159
 H.C.B-A1343 P160
 H.C.B-A1346 P206
 H.C.B-A1347 P054
 H.C.B-A1348 P161
 H.C.B-A1349 P041
 H.C.B-A1352 P129
 H.C.B-B1352 P129
 H.C.B-A1354 P252
 H.C.B-B1354 P252
 H.C.B-A1355 P234
 H.C.B-A1356 P130
 H.C.B-A1357 P164
 H.C.B-B1357 P164
 H.C.B-C1357 P163
 H.C.B-A1358 P234
 H.C.B-A1359 P234
 H.C.B-A1360 P235

H.C.B-A1361 P235
 H.C.B-A1362 P235
 H.C.B-A1364 P162
 H.C.B-A1365 P298
 H.C.B-A1366 P125
 H.C.B-A1367 P206
 H.C.B-A1368 P165
 H.C.B-A1369 P023
 H.C.B-B1370 P296
 H.C.B-A1371 P314
 H.C.B-A1372 P165
 H.C.B-A1373 P165
 H.C.B-A1374 P245
 H.C.B-B1374 P245
 H.C.B-C1374 P246
 H.C.B-A1375 P137
 H.C.B-B1375 P137
 H.C.B-A1376 P291
 H.C.B-B1376 P291
 H.C.B-A1377 P023
 H.C.B-A1378 P236
 H.C.B-A1379 P028
 H.C.B-A1381 P236
 H.C.B-A1382 P236
 H.C.B-A1385 P124







010

HWANG CHERNG BIN
Specialty Tools Inc.

目錄索引
Index

Index

H.C.B-A1386	P165	H.C.B-A1414	P171	H.C.B-A1447	P239
H.C.B-A1388	P272	H.C.B-A1416	P262	H.C.B-B1447	P187
H.C.B-A1389	P011	H.C.B-A1417	P316	H.C.B-A1449	P138
H.C.B-B1389	P011	H.C.B-A1418	P317	H.C.B-A1450	P202
H.C.B-A1392	P110	H.C.B-B1419	P172	 H.C.B-B1450	P202
H.C.B-A1394	P109	H.C.B-A1420	P045	H.C.B-A1451	P096
H.C.B-B1394	P109	H.C.B-A1421	P117	 H.C.B-B1451	P096
H.C.B-C1394	P109	H.C.B-B1421	P117	H.C.B-A1452	P092
H.C.B-A1395	P238	H.C.B-C1421	P116	H.C.B-A1453	P099
H.C.B-A1396	P316	H.C.B-A1424	P144	H.C.B-A1455	P083
H.C.B-A1399	P028	H.C.B-A1425	P173	H.C.B-A1456	P131
H.C.B-A1400	P201	H.C.B-A1426	P373	H.C.B-A1457	P263
H.C.B-A1401	P125	H.C.B-A1427	P238	H.C.B-A1458	P079
H.C.B-A1405	P208	H.C.B-A1428	P202	H.C.B-A1459	P201
H.C.B-B1405	P209	H.C.B-A1429	P173	H.C.B-A1460	P065
 H.C.B-C1405	P209	H.C.B-A1430	P174	H.C.B-A1461	P013
H.C.B-A1406	P238	H.C.B-A1431	P174	H.C.B-B1461	P013
H.C.B-A1408	P114	H.C.B-A1433	P138	H.C.B-A1463	P203
H.C.B-A1413	P171	H.C.B-A1436	P047	H.C.B-A1464	P110
H.C.B-B1413	P170	H.C.B-A1437	P110	H.C.B-A1467	P264
H.C.B-C1413	P170	H.C.B-A1438	P108	H.C.B-A1468	P027
H.C.B-D1413	P169	H.C.B-A1440	P283	H.C.B-A1469	P318
H.C.B-E1413	P168	H.C.B-A1445	P262	H.C.B-A1470	P175
H.C.B-F1413	P168	 H.C.B-C1445	P263	H.C.B-A1471	P174
H.C.B-G1413	P168	H.C.B-A1446	P021	H.C.B-A1473	P175
				H.C.B-B1473	P175



010

HWANG CHERNG BIN
Specialty Tools Inc.

Index

H.C.B-C1473 P175

 H.C.B-D1473 P175

H.C.B-A1474 P125

H.C.B-B1475 P167

H.C.B-A1476 P093

H.C.B-A1477 P122

H.C.B-A1479 P176

H.C.B-A1480 P006

H.C.B-A1484 P208

H.C.B-A1485 P208

H.C.B-A1486 P176

H.C.B-A1487 P071

H.C.B-A1489 P176

H.C.B-A1497 P320

H.C.B-A1498 P126

H.C.B-A1499 P320

H.C.B-A1500..... P126

H.C.B-A1501 P178

H.C.B-A1502 P377

H.C.B-B1502 P378

H.C.B-C1502 P378

H.C.B-A1503 P248

H.C.B-B1503 P248

H.C.B-C1503 P249

H.C.B-A1504 P054

H.C.B-A1505 P178

H.C.B-A1506 P178

H.C.B-B1506 P179

 H.C.B-D1506 P178

H.C.B-A1507 P180

H.C.B-A1508 P180

H.C.B-A1509 P181

H.C.B-A1510 P140

H.C.B-A1511 P126

H.C.B-A1512 P153

H.C.B-A1513 P181

H.C.B-A1514 P182

H.C.B-B1514 P182

 H.C.B-C1514 P182

H.C.B-A1515 P183

H.C.B-A1516 P045

H.C.B-A1517 P106

H.C.B-A1517-1 P106

&5&6

H.C.B-A1517-2&7 P106

H.C.B-A1517-3 P106

H.C.B-A1518 P119

H.C.B-A1519 P183

H.C.B-A1522 P183

H.C.B-A1523 P120

H.C.B-A1524 P045

H.C.B-A1525 P184

H.C.B-A1526 P104

H.C.B-A1527 P322

H.C.B-A1528 P123

H.C.B-A1530 P139

H.C.B-A1531 P323

H.C.B-A1532 P141

H.C.B-A1534 P110

H.C.B-A1535 P022

H.C.B-B1535 P022

H.C.B-A1536 P190

H.C.B-A1537 P323

H.C.B-A1539 P104

H.C.B-A1540 P114

H.C.B-A1541 P382

H.C.B-A1542 P115

H.C.B-B1542 P115

H.C.B-A1543 P279

H.C.B-A1544 P189

H.C.B-B1544 P189

H.C.B-A1545 P239

H.C.B-A1546 P046

H.C.B-B1546 P046



010

HWANG CHERNG BIN
Specialty Tools Inc.

目錄索引
Index

Index

H.C.B-C1546 P046	H.C.B-A1568 P078	H.C.B-A1597 P123
H.C.B-A1547 P186	H.C.B-B1568 P078	H.C.B-A1598 P053
H.C.B-A1548 P187	H.C.B-A1570 P071	H.C.B-B1598 P053
H.C.B-A1549 P187	H.C.B-A1571 P278	H.C.B-A1599 P055
H.C.B-A1550 P107	H.C.B-A1573 P265	H.C.B-A1604..... P185
H.C.B-A1551 P179	H.C.B-A1575 P191	H.C.B-A1605 P104
H.C.B-B1551 P179	H.C.B-A1576 P192	H.C.B-A1607 P194
H.C.B-C1551 P180	H.C.B-A1577 P055	H.C.B-A1611 P326
H.C.B-A1552 P188	H.C.B-A1578 P191	H.C.B-A1612 P268
H.C.B-B1552 P188	H.C.B-A1580 P192	H.C.B-A1613 P054
H.C.B-C1552 P188	H.C.B-A1583 P141	H.C.B-A1619 P240
H.C.B-A1553 P108	H.C.B-A1584 P186	H.C.B-A1620 P139
H.C.B-A1554 P267	H.C.B-A1585 P220	H.C.B-A1621 P221
H.C.B-B1554 P267	H.C.B-B1585 P220	H.C.B-A1622 P014
H.C.B-A1555 P077	H.C.B-A1587 P104	H.C.B-B1622 P014
H.C.B-A1556 P105	H.C.B-A1588 P078	H.C.B-A1623 P269
H.C.B-A1558 P055	H.C.B-A1589 P053	H.C.B-A1624 P015
H.C.B-A1559 P055	H.C.B-B1589 P053	H.C.B-B1624 P015
H.C.B-A1563 P141	H.C.B-A1590 P104	H.C.B-A1629 P219
H.C.B-A1564 P239	H.C.B-A1591 P192	H.C.B-A1631 P195
H.C.B-A1565 P171	H.C.B-A1593 P097	H.C.B-A1632 P195
H.C.B-A1566 P132	H.C.B-B1594 P193	H.C.B-A1633 P195
H.C.B-B1566 P132	H.C.B-A1595 P193	H.C.B-A1637 P333
H.C.B-C1566 P132	H.C.B-A1596 P086	H.C.B-A1638 P240
H.C.B-D1566 P132	H.C.B-B1596 P086	H.C.B-A1639 P296
H.C.B-A1567 P124		



010
HWANG CHERNG BIN
 Specialty Tools Inc.

Index

H.C.B-A1640 P046	H.C.B-A2004 P341	H.C.B-B2015 P345
H.C.B-A1641 P003	H.C.B-A2005 P414	H.C.B-A2016 P286
H.C.B-A1642 P173	H.C.B-A2005-1 P414	H.C.B-B2016 P286
H.C.B-A1643 P278	H.C.B-A2006 P136	H.C.B-C2016 P287
H.C.B-A1644 P055	H.C.B-A2006-1 P136	H.C.B-D2016 P287
H.C.B-A1645 P214	H.C.B-A2007 P136	H.C.B-E2016 P287
H.C.B-A1647 P070	H.C.B-A2008 P048	H.C.B-F2016 P288
H.C.B-A1649 P133	H.C.B-A2008-14 P048	H.C.B-G2016 P288
H.C.B-A1650 P133	H.C.B-A2008-15 P048	H.C.B-H2016 P288
H.C.B-A1651 P133	H.C.B-A2008-16 P048	H.C.B-I2016 P186
H.C.B-A1652 P133	H.C.B-A2008-16T P048	H.C.B-J2016 P127
H.C.B-A1653 P133	H.C.B-A2008-17 P048	H.C.B-A2017 P019
H.C.B-A1655 P376	H.C.B-A2008-18 P048	H.C.B-A2018-4 P294
H.C.B-A1656 P097	H.C.B-A2008-19 P048	H.C.B-A2018-6 P294
H.C.B-A1657 P107	H.C.B-A2009 P329	H.C.B-A2018-7 P294
H.C.B-A1659 P127	H.C.B-B2009 P333	H.C.B-A2018-8 P294
H.C.B-A1660 P240	H.C.B-A2010 P338	H.C.B-A2018-9 P295
H.C.B-A1662 P154	H.C.B-A2011 P338	H.C.B-A2018-10 P295
H.C.B-A1665 P268	H.C.B-A2012 P332	H.C.B-A2018-15 P295
H.C.B-A2001 P340	H.C.B-A2013 P331	H.C.B-A2018-16 P295
H.C.B-A2003 P037	H.C.B-A2014 P285	H.C.B-A2019 P345
H.C.B-B2003 P037	H.C.B-A2014-1 P285	H.C.B-A2020 P347
H.C.B-C2003 P037	H.C.B-B2014 P286	H.C.B-A2021 P347



010
HWANG CHERNG BIN
Specialty Tools Inc.

目錄索引
Index

Index

H.C.B-A2022	P347	H.C.B-A2038	P349	H.C.B-A2054	P299
H.C.B-A2023	P348	H.C.B-B2038	P349	H.C.B-B2054	P061
H.C.B-A2023-1	P348	H.C.B-A2039	P349	H.C.B-A2055	P256
H.C.B-A2024	P349	H.C.B-A2040	P250	H.C.B-A2056	P350
H.C.B-A2024-8	P126	H.C.B-B2040	P250	H.C.B-A2057	P243
H.C.B-B2025	P414	H.C.B-A2041	P250	H.C.B-A2058	P297
H.C.B-B2026	P293	H.C.B-B2041	P250	H.C.B-B2058	P297
H.C.B-A2027	P293	H.C.B-A2042	P298	H.C.B-C2058	P298
H.C.B-A2028	P348	H.C.B-B2043	P346	H.C.B-D2058	P298
H.C.B-A2029	P348	H.C.B-A2044	P255	H.C.B-A2059	P352
H.C.B-A2030	P224	H.C.B-A2046	P415	H.C.B-A2059-1	P352
H.C.B-B2030	P224	H.C.B-A2047	P415	H.C.B-B2059	P352
H.C.B-C2030	P225	H.C.B-A2048	P415	H.C.B-C2059	P352
H.C.B-D2030	P225	H.C.B-A2049	P338	H.C.B-A2060	P339
H.C.B-B2031	P311	H.C.B-A2049-1	P338	H.C.B-B2060	P339
H.C.B-C2031	P311	H.C.B-A2049-2	P338	H.C.B-C2060	P339
H.C.B-A2033	P293	H.C.B-A2050	P353	H.C.B-D2060	P339
H.C.B-A2034	P415	H.C.B-A2050-1	P353	H.C.B-E2060	P340
H.C.B-A2035	P331	H.C.B-A2050-2	P353	 H.C.B-F2060	P340
H.C.B-A2036	P060	H.C.B-B2050	P353	H.C.B-A2061	P351
H.C.B-A2037	P249	H.C.B-A2051	P350	H.C.B-A2062	P353
H.C.B-B2037	P249	H.C.B-A2052	P255	H.C.B-B2062	P353
H.C.B-C2037	P250	H.C.B-A2053	P256	H.C.B-C2062	P353





010

HWANG CHERNG BIN
Specialty Tools Inc.

Index

H.C.B-A2063 P299
 H.C.B-A2065 P300
 H.C.B-A2066 P301
 H.C.B-A2067 P301
 H.C.B-A2068 P350
 H.C.B-B2068 P350
 H.C.B-A2069 P155
 H.C.B-A2069-T30 P154
 H.C.B-A2069-T40 P154
 H.C.B-A2069-T45 P154
 H.C.B-A2069-T50 P154
 H.C.B-B2069 P155
 H.C.B-A2070 P166
 H.C.B-B2070 P166
 H.C.B-C2070 P166
 H.C.B-A2071 P256
 H.C.B-A2072 P256
 H.C.B-A2073 P351
 H.C.B-A2074 P351
 H.C.B-A2075 P351
 H.C.B-A2076 P354
 H.C.B-A2077 P354
 H.C.B-A2078 P354

H.C.B-A2079 P256
 H.C.B-B2079 P257
 H.C.B-C2079 P257
 H.C.B-D2079 P257
 H.C.B-A2080 P099
 H.C.B-A2081 P354
 H.C.B-B2081 P355
 H.C.B-A2082 P355
 H.C.B-B2082 P355
 H.C.B-C2082 P356
 H.C.B-A2083 P355
 H.C.B-A2084 P345
 H.C.B-A2085 P167
 H.C.B-A2086 P356
 H.C.B-A2087 P155
 H.C.B-A2088 P258
 H.C.B-A2089 P304
 H.C.B-B2089 P305
 H.C.B-A2090 P305
 H.C.B-B2090 P305
 H.C.B-C2090 P305
 H.C.B-B2091 P358
 H.C.B-A2092 P358





H.C.B-A2094 P308
 H.C.B-B2094 P308
 H.C.B-D2094 P309
 H.C.B-A2095 P259
 H.C.B-B2095 P259
 H.C.B-C2095 P258
 H.C.B-A2096 P300
 H.C.B-A2097 P305
 H.C.B-A2098 P310
 H.C.B-A2099 P258
H.C.B-A2100 P314
 H.C.B-A2103 P356
 H.C.B-A2103-0516 P219
 H.C.B-A2104 P357
 H.C.B-A2105 P357
 H.C.B-B2105 P119
 H.C.B-A2106 P357
 H.C.B-A2107 P359
 H.C.B-B2107 P359
 H.C.B-A2108 P157
 H.C.B-A2109 P157
 H.C.B-A2110 P151
 H.C.B-A2111 P359



010
HWANG CHERNG BIN
Specialty Tools Inc.

目錄索引
Index

Index

H.C.B-B2111 P360	H.C.B-A2129 P346	H.C.B-A2155 P024
H.C.B-D2111 P360	H.C.B-A2131 P135	H.C.B-B2155 P024
H.C.B-A2112 P223	H.C.B-A2134 P272	H.C.B-B2155-24 P167
H.C.B-A2113 P304	H.C.B-A2135 P020	 H.C.B-D2155-27 P025
H.C.B-B2113 P304	H.C.B-A2136 P017	 H.C.B-D2155-31 P025
H.C.B-A2114 P310	H.C.B-B2136 P018	H.C.B-A2156 P292
H.C.B-A2115 P330	H.C.B-A2137 P161	H.C.B-A2159 P331
H.C.B-A2116 P290	H.C.B-B2138 P362	H.C.B-A2160 P315
H.C.B-A2117 P020	H.C.B-B2138-1 P362	 H.C.B-B2160 P315
H.C.B-B2119 P313	H.C.B-A2139 P415	H.C.B-A2161 P051
H.C.B-A2121 P312	H.C.B-A2140 P362	H.C.B-A2162 P365
H.C.B-B2121 P312	H.C.B-A2141 P367	H.C.B-A2163 P365
H.C.B-C2121 P313	H.C.B-A2142 P363	H.C.B-A2164 P363
H.C.B-D2121 P313	H.C.B-A2143 P300	H.C.B-A2165 P366
H.C.B-B2122 P255	H.C.B-A2144 P360	H.C.B-B2165 P366
H.C.B-C2122 P255	H.C.B-A2145 P364	H.C.B-C2165 P366
H.C.B-A2123 P281	H.C.B-A2146 P364	H.C.B-D2165 P366
 H.C.B-B2124 P326	H.C.B-A2149 P301	H.C.B-A2167 P366
H.C.B-A2125 P310	H.C.B-A2150 P302	H.C.B-B2167 P373
H.C.B-A2128 P360	H.C.B-A2151 P364	H.C.B-A2169 P370
H.C.B-B2128 P361	H.C.B-A2152 P362	H.C.B-A2171 P273
H.C.B-C2128 P361	H.C.B-A2153 P365	H.C.B-A2172 P297
H.C.B-D2128 P361	H.C.B-A2154 & A2090 P158	H.C.B-A2173 P416



010
HWANG CHERNG BIN
 Specialty Tools Inc.

Index

H.C.B-A2174	P021	H.C.B-C2189	P023	H.C.B-A2211	P161
H.C.B-B2174	P070	H.C.B-A2190	P369	H.C.B-A2213	P308
H.C.B-A2175	P243	H.C.B-A2191	P369	H.C.B-A2214	P279
H.C.B-A2176	P368	H.C.B-A2192	P314	H.C.B-A2216	P280
H.C.B-A2177	P368	H.C.B-B2192	P315	H.C.B-A2217	P138
H.C.B-A2179	P283	H.C.B-C2195	P358	H.C.B-A2218	P297
H.C.B-A2180	P225	H.C.B-A2196	P370	H.C.B-A2219	P209
H.C.B-A2181	P158	H.C.B-A2197	P307	H.C.B-A2220	P297
H.C.B-B2181	P158	H.C.B-B2197	P307	H.C.B-A2221	P281
H.C.B-A2182	P368	H.C.B-A2198	P272	H.C.B-A2223	P292
H.C.B-A2183	P260	H.C.B-A2199	P280	H.C.B-B2224	P166
H.C.B-B2183	P261	H.C.B-B2199	P281	H.C.B-A2225	P299
H.C.B-C2183	P261	H.C.B-A2200..... P416		H.C.B-A2227	P372
H.C.B-D2183	P261	 H.C.B-B2200	P417	H.C.B-B2227	P372
H.C.B-E2183	P262	H.C.B-A2201	P161	H.C.B-C2227	P372
H.C.B-A2184	P260	H.C.B-A2202	P244	H.C.B-A2229	P372
H.C.B-B2184	P260	H.C.B-A2203	P371	H.C.B-A2230	P373
H.C.B-C2184	P260	H.C.B-A2204	P062	H.C.B-A2230-T100	P062
H.C.B-A2185	P332	H.C.B-A2205	P371	H.C.B-B2230	P373
H.C.B-A2186	P051	H.C.B-A2206	P371	H.C.B-C2230	P374
H.C.B-A2187	P051	H.C.B-A2207	P162	H.C.B-A2231	P263
H.C.B-A2189	P023	H.C.B-A2208	P137	H.C.B-A2232	P174
H.C.B-B2189	P083	H.C.B-C2210	P303		

















010

HWANG CHERNG BIN
Specialty Tools Inc.

目錄索引
Index

Index

H.C.B-A2233	P036	H.C.B-A2260	P184	H.C.B-A2285	P416
H.C.B-A2234	P264	H.C.B-A2261	P321	H.C.B-A2286	P416
H.C.B-A2235	P375	H.C.B-A2262	P265	H.C.B-B2286	P417
H.C.B-B2235	P374	H.C.B-A2263	P321	H.C.B-A2287	P417
H.C.B-C2235	P375	H.C.B-A2264	P265	H.C.B-A2288	P084
H.C.B-A2236	P374	H.C.B-A2265	P380	H.C.B-B2288	P084
H.C.B-A2237	P319	H.C.B-A2266	P322	H.C.B-C2288	P084
H.C.B-A2241	P318	H.C.B-A2267	P185	 H.C.B-D2288	P221
H.C.B-A2242	P318	H.C.B-A2268	P185	H.C.B-A2289	P333
H.C.B-A2243	P283	H.C.B-A2272	P333	H.C.B-A2290	P326
H.C.B-A2244	P319	H.C.B-A2274	P323	H.C.B-A2292	P019
H.C.B-A2248	P319	H.C.B-A2275	P053	H.C.B-A2293	P266
H.C.B-A2249	P318	H.C.B-A2276	P194	 H.C.B-B2293	P077
H.C.B-A2250	P317	 H.C.B-B2276	P194	H.C.B-B2294	P359
 H.C.B-C2250	P317	 H.C.B-C2276	P193	 H.C.B-C2294	P358
H.C.B-A2251	P050	H.C.B-A2277	P266	 H.C.B-A2295	P327
H.C.B-A2252	P320	H.C.B-A2278	P083	 H.C.B-A2296	P327
H.C.B-A2253	P376	H.C.B-A2279	P323	 H.C.B-B2296	P327
H.C.B-A2254	P376	H.C.B-B2279	P324	 H.C.B-A2297	P324
H.C.B-A2255	P321	H.C.B-C2279	P324	 H.C.B-B2297	P324
H.C.B-A2256	P177	H.C.B-A2283	P382	 H.C.B-C2297	P325
H.C.B-B2256	P177	H.C.B-A2284	P203	 H.C.B-A2298	P326
H.C.B-A2257	P377	H.C.B-B2284	P203	 H.C.B-B2299	P382
H.C.B-A2258	P381				



New H.C.B-A2300 P307	H.C.B-A3009 P392	H.C.B-A3030 P395
New H.C.B-A2301 P306	H.C.B-A3010 P392	H.C.B-A3031 P394
New H.C.B-A2302 P306	H.C.B-A3011 P392	H.C.B-A3032 P394
New H.C.B-A2303 P325	H.C.B-A3012 P392	H.C.B-A3033 P394
New H.C.B-A2304 P325	H.C.B-A3012-1 P393	H.C.B-A3034 P395
New H.C.B-A2306 P383	H.C.B-B3012 P393	H.C.B-A3035 P395
New H.C.B-A2307 P327	H.C.B-A3013 P401	H.C.B-A3036 P388
New H.C.B-A2308 P255	H.C.B-A3014 P390	H.C.B-B3036 P388
New H.C.B-A2310 P316	H.C.B-A3015 P390	H.C.B-C3036 P388
New H.C.B-A2311 P243	H.C.B-A3016 P386	H.C.B-D3036 P388
New H.C.B-A2312 P316	H.C.B-A3017 P386	H.C.B-E3036 P389
New H.C.B-A2314 P055	H.C.B-A3018 P385	New H.C.B-F3036 P389
New H.C.B-A2315 P269	H.C.B-A3019 P385	H.C.B-A3037-A P396
New H.C.B-A2316 P383	H.C.B-A3020 P391	H.C.B-A3037-B P396
H.C.B-A3001 P387	H.C.B-A3021 P391	H.C.B-A3038 P396
H.C.B-B3001 P387	H.C.B-A3022 P393	H.C.B-A3039 P396
H.C.B-A3002 P387	H.C.B-A3023 P393	H.C.B-A3040 P398
H.C.B-A3003 P386	H.C.B-A3024 P397	H.C.B-A3041 P399
H.C.B-A3004 P389	H.C.B-A3025 P397	H.C.B-A3042 P398
H.C.B-A3005 P390	H.C.B-A3026 P397	H.C.B-A3043 P398
H.C.B-A3006 P390	H.C.B-A3027 P397	H.C.B-A3044 P399
H.C.B-A3007 P391	H.C.B-A3028 P398	H.C.B-A3045 P399
H.C.B-A3008 P391	H.C.B-A3029 P394	H.C.B-A3046 P399



010
HWANG CHERNG BIN
Specialty Tools Inc.

目錄索引
Index

Index

H.C.B-A3047 P400	H.C.B-A4008 P276	H.C.B-A6001 P411
H.C.B-A3048 P400	H.C.B-A4009 P276	H.C.B-A6002 P411
H.C.B-A3049 P400	H.C.B-A4010 P276	H.C.B-A6003 P411
H.C.B-A3050 P400	H.C.B-A4011 P277	H.C.B-A6004 P411
H.C.B-A3051 P401	H.C.B-A4012 P277	H.C.B-A6005-5 P380
H.C.B-A3052 P401	H.C.B-A4013 P139	H.C.B-A7001 P227
H.C.B-A3053 P401	H.C.B-A4014 P277	H.C.B-A7002 P226
H.C.B-A3054 P402	H.C.B-A5001 P406	H.C.B-A7003 P227
H.C.B-A3055 P402	H.C.B-A5002 P406	H.C.B-A7004 P228
H.C.B-A3056 P402	H.C.B-A5003 P406	H.C.B-A7005 P228
H.C.B-A3057 P402	H.C.B-A5004 P406	H.C.B-B7005 P228
H.C.B-A3058 P402	H.C.B-A5005-EA P407	H.C.B-A7006 P228
H.C.B-A3059 P403	H.C.B-A5005-GE P407	H.C.B-A7007 P229
New H.C.B-A3060 P403	H.C.B-A5005-JP P407	H.C.B-A7008 P229
New H.C.B-B3060 P403	H.C.B-A5006 P407	H.C.B-A7009 P230
New H.C.B-A3061 P404	H.C.B-A5007 P408	H.C.B-A7010 P230
New H.C.B-B3061 P404	H.C.B-A5008 P408	H.C.B-A7011 P231
H.C.B-A4001 P273	H.C.B-A5009 P408	H.C.B-A7012 P231
H.C.B-A4002 P274	H.C.B-A5010 P408	H.C.B-A7013 P232
H.C.B-A4004 P274	H.C.B-A5011 P409	H.C.B-A7014 P232
H.C.B-A4005 P274	H.C.B-B5011 P409	H.C.B-A8001 P412
H.C.B-A4006 P275	H.C.B-A5012 P409	H.C.B-L1001 P210
H.C.B-A4007 P275	H.C.B-A5013 P408	H.C.B-L1002 P210



010
HWANG CHERNG BIN
Specialty Tools Inc.

Index

H.C.B-L1003	P210
H.C.B-L1004	P211
H.C.B-L1005	P211
H.C.B-L1006	P211
H.C.B-L1007	P212
H.C.B-L1008	P212
H.C.B-L1009	P212
H.C.B-L1010	P212
H.C.B-L1011	P213
H.C.B-L1012	P213
H.C.B-L1013	P213
H.C.B-L1014	P214



010

HWANG CHERNG BIN
Specialty Tools Inc.

賓士底盤修護工具

BENZ CHASSIS REPAIR TOOL

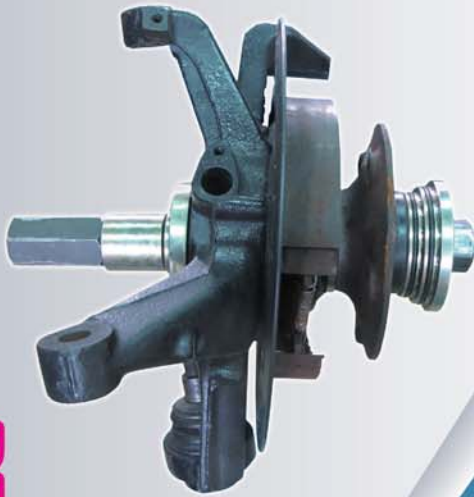



010
HWANG CHERNG BIN
Specialty Tools Inc.

SINCE 1990

Benz Chassis



H.C.B-A1001

ON CAR

BENZ (W124) DIFFERENTIAL BUSH REMOVAL/ INSTALLATION TOOL KIT PAT. 165163 USA PAT. 6389668

BENZ (W124) 免卸差速器·後三角架橡皮座鐵套拆裝工具組 (124 352 77 65)

10 / 19.3 / 20.3 / 1.55'

- Extractor for replacing the differential mounting metallic bushes in the rear sub-frame for MERCEDES type W124.
- Replace mounting bushes without removing of the differential.



H.C.B-A1002

ON CAR

BENZ REAR AXLES BUSH REMOVAL/ INSTALLATION TOOL KIT PAT. 165163 USA PAT. 6389668

BENZ 後羊角鐵套拆裝工具組 (全車系)

10 / 16.5 / 17 / 1.55'

- Removal and replacement tool for metallic bushes on rear axles MERCEDES type W201/W124/W202/W140/W129/W210/W220
- The tool incorporates with an axial bearing or a pressure piece which guarantees labor saving.
- The correct position of the new metallic bushes when replaced.



H.C.B-A1008-1

ON CAR

BENZ AXLES WHEEL BEARING REMOVAL/ INSTALLATION TOOL KIT PAT. 201280 USA PAT.

BENZ 免拆三角架前後輪軸承拆裝工具組

2 / 21.5 / 22.6 / 0.86'

- A great tool can be used in replacing wheel bearings without removing the steering knuckle and strut assembly.
- As the spindle assembly isn't removed, there is no need to align front end after the job is done. It is time saver.
- Application: MERCEDES-BENZ, BMW, TOYOTA, VW, MARCH, FORD, VOLVO ... etc.



STEP 1. EXTRACT AXLE HUB



HUB INSTALLATION STEP 1



STEP 2



HUB INSTALLATION STEP 2



STEP 3. EXTRACT BEARING



HUB INSTALLATION FINISHED



STEP 4. INSTALL BEARING



010
HWANG CHERNG BIN
Specialty Tools Inc.

賓士底盤修護工具
BENZ Chassis Repair Tool

H.C.B-B1008

NEW

UNIVERSAL AXLES WHEEL BEARING REMOVAL/INSTALLATION TOOL KIT PAT. 201280 USA PAT.

通用免拆三角架前後輪軸承拆裝工具組



Function

- A great tool for replacing the wheel bearings without removing the steering knuckle & strut assembly.
- Because the spindle assembly isn't removed, there is no need to align front end after the job is done. It is time saver.
- Application: MERCEDES-BENZ ML (W163), MERCEDES-BENZ (W140), BMW (E39) , BMW (E36/E46) ,VW TOUARG, VW GOLF, VW A4, TOYOTA, MARCH, FORD, VOLVO.....etc.

VW TOUARG Bearing Remvoal



VW TOUARG Bearing Installation



VW TOUARG Axle Installation



H.C.B-A1641

NEW

UNIVERSAL LOCKING RING TOOL PAT.

萬能扣環鉗

- A new type of lock ring tool which makes dismounting and mounting of wheel bearing lock rings very easy.
- The tool is designed to fit the larger lock rings for example the lock ring on the axle shaft or other lock rings on passenger cars, light commercial vehicles and trucks.
- The adjusting screw has a ¼ " ratchet grip which provides enough power to easily remove stuck and rusted lock rings. The grip angle between the tips will also always be correct no matter the size or position of the lock ring. This makes the tool safer, more effective and easier to use than ordinary pliers.
- It contains a total of 3 kinds of specially designed tips that can easily be switched if needed.
- Content:
A1641-025 Circlip pin 2.5 mm, 2 pcs
A1641-030 Circlip pin 3 mm, 2 pcs
A1641-035 Circlip pin 3.5 mm, 2 pcs



Benz Chassis

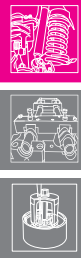



010
HWANG CHERNG BIN
 Specialty Tools Inc.

Benz Chassis



H.C.B-A1003

ON CAR

BENZ (W124/W201) SUSPENSION BUSH REMOVAL/ INSTALLATION TOOL KIT PAT. 158341

BENZ (W124/W201) 工字樑鐵套拆裝工具組

2 / 18.5 / 19.1 / 0.84'

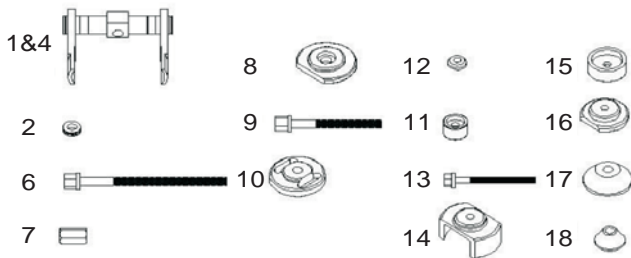

- Extractor for replacing the front and rear metallic rear sub-frame mounting bushes. For MERCEDES type W201/W124.
- Replace mounting bushes without lowering the complete rear axle assembly.

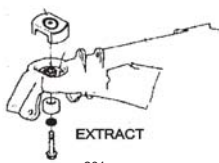

W²⁰¹₁₂₄ 351 19 42 FRONT BUSH

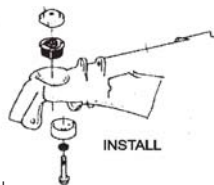

INSTALL

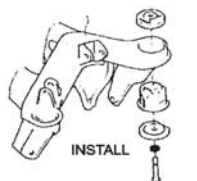

W²⁰¹₁₂₄ 351 02 42 FRONT BUSH

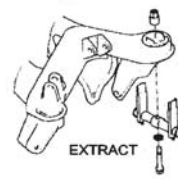

EXTRACT

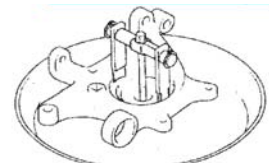

AXLE BEARING EXTRACT

H.C.B-A1018

ON CAR

BENZ (W126) REAR AXLE FLANGE NUT SOCKET

BENZ (W126) 傳動軸專用套筒

30 / 21 / 23.5 / 0.67'

- The special socket removes rear axle flange grooved nuts on MERCEDES-BENZ W107/114/115/116/126 axle with CV joints when replacing axle seals bearings.



H.C.B-A1123 **ON CAR** BENZ (W140) LOWER CONTROL ARM BUSH REMOVAL/ INSTALLATION TOOL KIT (IMPROVEMENT)

BENZ (W140) 三角架鐵套拆裝工具組 (改良型)

2 / 18.8 / 20.4 / 0.76'

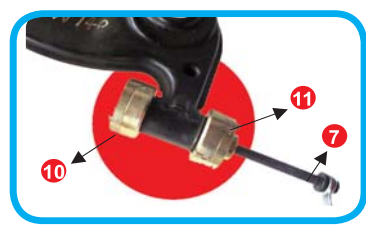

BUSH1 EXTRACT STEP 1



BUSH1 EXTRACT STEP 2

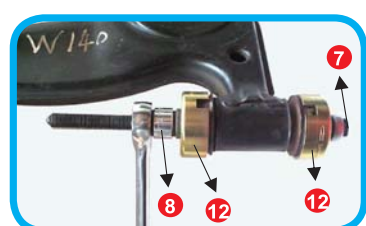

BUSH1 INSTALL

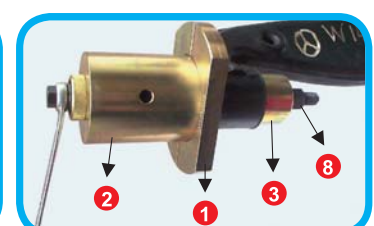

BUSH2 EXTRACT

- For removing or installing the rear rubber hydraulic mount in the lower control arm.
- Application: MERCEDES W140

Contents

Part No.	Description	Qty
A1123-1	Pair of jaws	1
A1123-2	Extraction support sleeve	1
A1123-3	Extraction pressure piece	1
A1123-4	Installation pressure piece	1
A1123-5	Bearing insert with bearing	1
A1123-6	Insertion support sleeve	1
A1123-7	Spindle M16 x 300	1
A1123-8	Shoulder nut M16	1
A1123-9	Extraction drift	1
A1123-10	Pressure piece without thread	1
A1123-11	Pressure piece with thread	1
A1123-12	Installation pressure piece	2

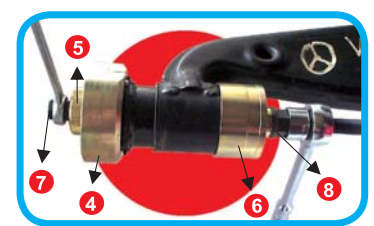

BUSH2 INSTALL

H.C.B-A1023 **ON CAR** BENZ (W140) LOWER CONTROL ARM BUSH REMOVAL/ INSTALLATION TOOL KIT (S-CLASS)

BENZ (W140) 三角架鐵套拆裝工具組 (S 系列)

4 / 22.8 / 23.8 / 1.28'



EXTRACTION



INSTALLATION



- For removing or installing the rear rubber hydraulic mount in the lower control arm.
- Application: MERCEDES model W140 (1993-1999)



H.C.B-A1024

ON CAR

BENZ (W210) LOWER CONTROL ARM BUSH REMOVAL/ INSTALLATION TOOL KIT (NEW E-CLASS)

BENZ (W210) 三角架鐵套拆裝工具組 (新 E 系列)

4 / 22.5 / 23.7 / 1.28'

- Puller and installation tool for front & rear lower wishbone rubber mount.
- Application: MERCEDES model W210 (1996-2001)

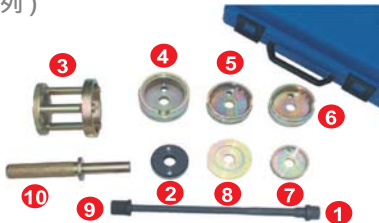

H.C.B-A1025

ON CAR

BENZ (W202/W170) LOWER CONTROL ARM BUSH REMOVAL/ INSTALLATION TOOL KIT (C-CLASS)

BENZ(W202/W170) 三角架鐵套拆裝工具組 (C 系列)

5 / 27 / 28 / 1.59'

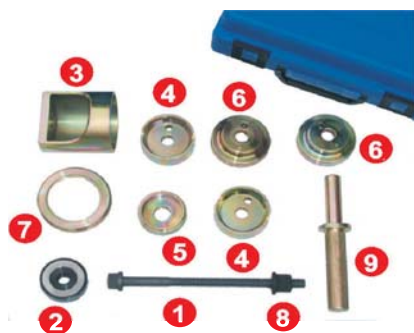

- Removal and installation tool for rear rubber mount on the lower wishbone for W170 and W202 chassis. Also can install front mount on W208 chassis.
- Application: MERCEDES model W202.W170 (1994-2002)

H.C.B-A1480

ON CAR

COIL SPRING COMPRESSOR KIT (WISHBONE SUSPENSION)

雙 A 臂避震器彈簧拆卸組

4 / 20.4 / 21.4 / 1.6'

- Designed to fit applications where the access hole in the lower wishbone is as small as 30mm diameter.
- Torque stick supplied: Max- 100 Nm
- Allows for use of an impact wrench
- Application: Chrysler, Chevrolet, Citroen, Ford, Honda, Hyundai, Kia, Mazda, Mitsubishi, Peugeot, Renault, Skoda, Suzuki, Toyota, Volvo, VW, BMW 3 series (1996~2013) Mercedes Benz: W202 / W204 (1997~ 2013)
- The three point lock key can help to install the spindle and jaw with high safety.





010
HWANG CHERNG BIN
Specialty Tools Inc.

賓士底盤修護工具
BENZ Chassis Repair Tool

H.C.B-A1030

BENZ SPRING COMPRESSOR TOOL KIT

BENZ 彈簧避震器拆裝工具組

5 / 28.5 / 29.5 / 2.46'

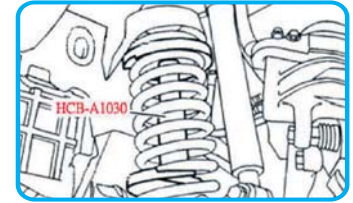

- ∅ 70 / 130: Mercedes-Benz (123,124,202,210,230(B)) / Saab / Ford / Skoda
- ∅ 90 / 150: Mercedes-Benz (126,140,100,200,230(F)) / OPEL / GM / LADA / Peugeot(406,605) / Rover / Hyundai / Saab / Volvo / VW / FIAT / Mazda / TOYOTA / Nissan / Mitsubishi / Ford
- Types: W116/124/126/129/201/202/140/170/210/ 220/230/211 and 4-matic includes.
- Advantage: Newly developed automatic 3-point safety
- Interlock and automatic freewheel at end of stroke.

H.C.B-B1040

BENZ (W203/W211) SPRING REMOVAL/ INSTALLATION TOOL KIT PAT. 073953

BENZ (W203/W211) 彈簧避震器拆裝工具組

- To change the old spring for new one.
- Movement range: 35 mm to 350 mm.
- Conjunction with B1022-05 and A1047-1.
- Application: BENZ (W203, W211), BMW, FORD.
- N.W.: 10.07 KGS

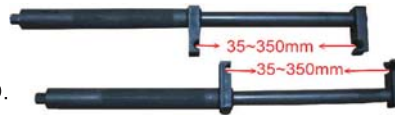

H.C.B-C1047

BENZ (W204/X204/W212) COIL SPRING JAW KIT

BENZ (W204/X204/W212) 更換避震器彈簧拆卸組

- Jaw set for coil springs on Mercedes Benz
- Designed for easier compression on the coil springs
- Stable and safe compressing of the shock absorber top lid.
- Application: Mercedes Benz W204 (C-class) X204 (CLK-class) W212 (E-class)
- For use with H.C.B-A1047



H.C.B-A1036

BENZ (W123/W126/W220) BALL JOINT REMOVAL/ INSTALLATION TOOL KIT PAT. 179835

BENZ (W123/W126/W220) 球接頭拆裝工具組

6 / 25.2 / 27.4 / 1'

- For pressing ball joint into steering knuckle.
- Application: W123, W126, W220



Benz Chassis





H.C.B-A1043

BENZ PARKING BRAKE INSTALLER

BENZ 手煞車來令片固定彈簧扳手

- Pressing spring of parking brake.
- Application :
MERCEDES M107,
M114, M115, M116,
M123, M124, M129,
M140, M201, M202
models.
- N.W.: 0.1 KGS



H.C.B-A1044

BENZ WHEEL STUD ALIGNMENT GUIDE TOOL (M12 x P1.5)

BENZ 輪胎定位銷 (M12 x P1.5)

- To assist mounting wheels, especially late models with Iron lug bolts.
- Application: All MERCEDES models with lug bolts
- N.W.: 0.1 KGS



H.C.B-A1044-1

BENZ WHEEL STUD ALIGNMENT GUIDE TOOL (M14 x P1.5)

BENZ 輪胎定位銷 (M14 x P1.5)

- To assist mounting wheels, especially late models with Iron lug bolts.
- Application: All MERCEDES models with lug bolts
- N.W.: 0.05 KGS



H.C.B-B1059

UNIVERSAL CALIPER PRESSURE TOOL (FOUR PISTONS)

通用型分泵回復器 (4 活塞)

- Movement Range: 16 ~ 90 mm
- Plate Size: 118 x 70 mm
- Material: S45C
- Hardness: HRC 35° ~ 40°
- N.W.: 2.8 KGS
- Application: BENZ (four pistons), BMW, VW, TOYOTA, FORD, and most of cars and light trucks.

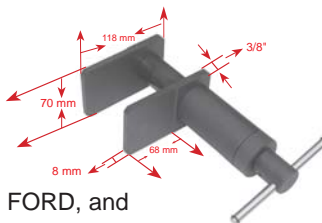

- An universal tool for pressing caliper pistons back into caliper housings with special broadened steel board.
- Due to the construction of this tool which incorporates high-precision hardened cylinder and piston, together with a built-in axial bearing, the highest precision allows easily function to press-back the pistons into the caliper.

H.C.B-A1059

BENZ CALIPER PRESSURE TOOL (FOUR PISTONS)

BENZ 煞車分泵壓縮器 (4 活塞)

10 / 19.4 / 22.2 / 1.05'



- An universal tool for pressing caliper pistons back into caliper housings.
- Due to the construction of this tool which incorporates high-precision hardened cylinder and piston, together with a built-in axial bearing.
- The highest precision allows easy function to press-back the pistons into the caliper.

H.C.B-A1068

ON CAR

BENZ (W140/W220) FRONT & REAR SUSPENSION BUSH REMOVAL/INSTALLATION TOOL KIT PAT.158341

BENZ (W140/W220) 工字樑前 / 後置鐵套拆裝工具組

- To remove and install the front and rear rubber subframe mounts of axle suspension.
- N.W.: 9.8 KGS G.W.: 10 KGS
- Application:
MERCEDES-BENZ S-class (W140) 1992~2000
MERCEDES-BENZ S-class (W220) 2000

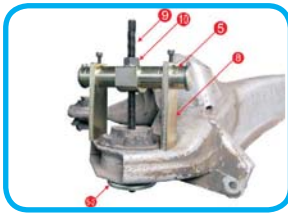
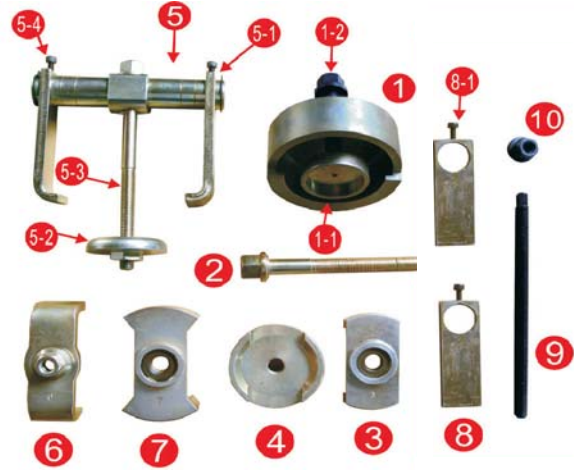

Used for remove W220 Front suspension bush

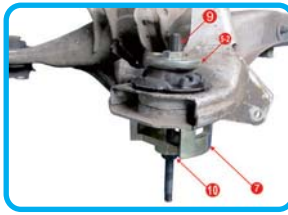

Use for Installer W220 Front suspension bush

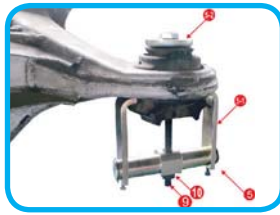

Used for remove W220 rear suspension bush

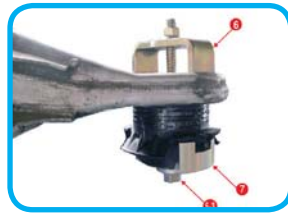

Used for installer W220 rear suspension bush



Front bush
NO. 220 35 1114 2



Rear bush
NO.220 350 03 75

H.C.B-A1082

UNIVERSAL BALL JOINT SEPARATOR KIT (24 mm)

萬用球接頭拆卸組 (24 mm)

30 / 25 / 26 / 0.67'

- Splitting track-rod ends, ball joints on anti-roll bar...etc., especially in confined space conditions like on AUDI, VW, BMW, FORD, MERCEDES (W170, W202, W210, W220 ... etc.), OPEL, VAUXHALL, MITSUBISHI etc.

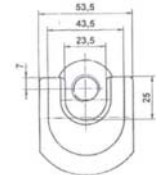
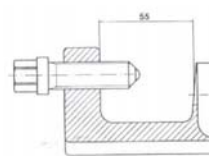

H.C.B-A1082-1

UNIVERSAL BALL JOINT SEPARATOR KIT (SCREW REPLACEABLE) (24 mm) PAT. 208928

萬用球接頭拆卸組 (可替換螺絲) (24 mm)

30 / 24.2 / 25.7 / 1.18'

- Splitting track-rod ends, ball joints on anti-roll bar...etc., especially in confined space conditions like on AUDI, VW, BMW, FORD, MERCEDES (W170, W202, W210, W220 ... etc.), OPEL / VAUXHALL, MITSUBISHI etc.



Benz Chassis

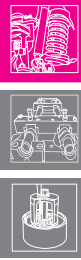



010
HWANG CHERNG BIN
Specialty Tools Inc.

SINCE 1990

Benz Chassis



H.C.B-A1083

UNIVERSAL BALL JOINT SEPARATOR KIT (21 mm)

萬用球接頭拆卸組 (21 mm)

30 / 19 / 20 / 0.67'

- Extractor for MERCEDES type 201/123/124/126/129...etc.
- Removal of the track-rod end from the drag link and also applicable to other vehicles.
- Application: VW, AUDI, BMW, OPEL, FORD, FIAT, RENAULT, PEUGEOT, CITROEN, VOLVO, SAAB, MISUBISHI, Japanese cars...etc.



H.C.B-A1092

UNIVERSAL BALL JOINT SEPARATOR (W202/W210/ W220) (24 mm)

萬用球接頭拆卸器 (W202/W210/W220) (24 mm)

30 / 14 / 15 / 0.67'

- Splitting track-rod ends, ball joints on anti-roll bar.. etc., especially in confined space conditions.



H.C.B-A1113

BENZ (W203/W209/R171) SUB-FRAME BUSH REMOVAL/ INSTALLATION TOOL KIT

BENZ(W203/W209/R171) 工字樑鐵套拆裝工具組

2 / 15.3 / 16.6 / 0.76'



- Extractor for replacing the front and rear metallic rear sub-frame mounting bushes.
- Replaces the mounting bushes without completely lowering rear axle assembly.
- Application: BENZ (W203/W209/R171)

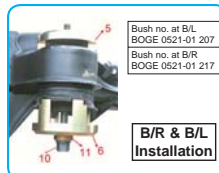
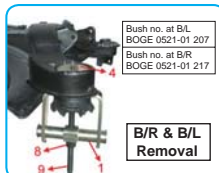
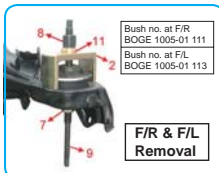

GENUINE STOCK NO. : 203 351 05 42



010
HWANG CHERNG BIN
Specialty Tools Inc.

賓士底盤修護工具
BENZ Chassis Repair Tool

H.C.B-B1389

BENZ (W203/W204/W211/W212/W220/W221) FRONT SUB-FRAME BUSH REMOVAL/ INSTALLATION TOOL KIT (W/ HYDRAULIC CYLINDER) (Dr. 3/8") PAT.

BENZ (W203/W204/W211/W212/W220/W221)
前三角架鐵套拆裝工具組 (油壓式) (3/8" 接頭)



Removal



Installation

- Providing safe removing/installing and labor saving by using hydraulic.
- Special design to remove and install the bush without take off any parts.
- On car maintenance.
- Various parts for widely use.
- Application: BENZ (W203/ W204/ W209/ W211/ W212/ W220/ W221)

+ You will also need to add:

H.C.B - A1554



H.C.B-A1389

ON CAR

BENZ (W203/W204/W209/W211/W212/W220/W221) FRONT SUB-FRAME BUSH REMOVAL/ INSTALLATION TOOL KIT PAT. M412840

BENZ (W203/W204/W209/W211/W212/W220/W221) 前三角架鐵套拆裝工具組

- No.1-10 are H.C.B-A1111
- Application: BENZ (W203/ W204/ W209/ W211/ W212/ W220/ W221)

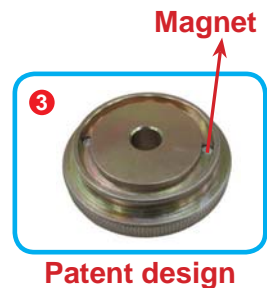

Benz Chassis





010
HWANG CHERNG BIN
Specialty Tools Inc.

Benz Chassis

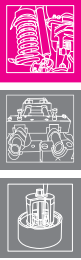

H.C.B-C1111

ON CAR

BENZ (W203/W204/W209/W211/W220) SUB-FRAME & BENZ (W211) FRONT SUSPENSION ARM BUSH REMOVAL/ INSTALLATION TOOL KIT USA PAT.6389668 PAT.201280

BENZ (W203/W204/W209/W211/W220) 三角台鐵套 & BENZ (W211) 前三角架懸掛控制臂鐵套拆裝工具組

3 / 25.5 / 26.5 / 2.6'

- For quick, safe removal and installation of the bushes in the sub-frame (W203/W204/W209/W211/W220) and suspension arm (W211)
- Using part No. 1 to 10 for the bush of BENZ W203/W211/W220 sub-frame
- Using part No. 1, 2, 3, 8, 11 to 14 for bush of BENZ W211 front suspension arm.
- On car maintenance
- Special design to remove & install the Bush without remove any parts.



(W211 operation)

H.C.B-A1111

ON CAR

BENZ (W203/W211/W220) SUB-FRAME BUSH REMOVAL/ INSTALLATION TOOL KIT USA PAT. 6389668 PAT.201280

BENZ (W203/W211/W220) 三角台鐵套拆裝工具組

5 / 29 / 29.5 / 1.59'



MODEL: BENZ W203



W220 EXTRACT



W220 INSTALL



W211 EXTRACT



W211 INSTALL

H.C.B-B1111

ON CAR

BENZ (W211) FRONT SUSPENSION ARM BUSH REMOVAL/ INSTALLATION TOOL KIT

BENZ (W211) 前三角架下控制臂鐵套拆裝工具組

- Special design to remove & install the Bush without remove any parts.
- On car maintenance.
- Special design to remove & install the bush without removing any part.
- Application: W211.
- The kit must combine with H.C.B-A1111-1, -2, -3, -8.



BENZ W211 Sub-Frame



Extraction



Installation



※ To install the bush from the angled side.

※ Using accessories No. 13 to press the bush before installation.

H.C.B-A1341 BENZ (W210) REAR SUB-FRAME BUSH REMOVAL/ INSTALLATION TOOL KIT

BENZ (W210) 後工字樑鐵套拆裝工具組



■ Extractor / Installer for W210 Rear Sub-Frame Bush
(Genuine Stock No.: 210 35105 42)

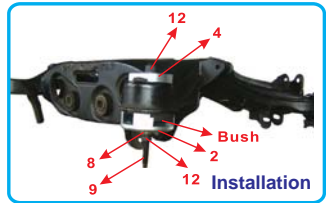
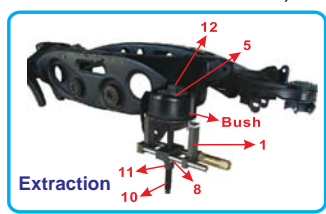

- For installing and removing the bushes on rear sub-frame.
- Genuine Stock No.:
210 35105 42
210 35108 42
- On car maintenance.
- Application: BENZ W210

H.C.B-B1461 BENZ (W221) WHEEL LUG SOCKET (17 mm) WITH PROTECTIVE SLEEVE

BENZ (W221) 輪胎套筒 (17 mm) 含保護套



- Material: CR-V
- Size: Dr. 1/2" x 86 mm (L)
- Application: Maybach and Mercedes C-Class (W204), E-Class (W211/W212/W207), SLK (W172), M-Class (W164/W166), CL-Class (W216), S-Class (W221/W222) which came installed with unique convex lug bolts (Mercedes # 000 990 5407).

H.C.B-A1461 BENZ (W221) WHEEL LUG SOCKET (17 mm)

BENZ (W221) 輪胎套筒 (17 mm)



- Material: CR-V
- Size: Dr. 1/2" x 45 mm (L)
- Application: Maybach, W221 (S-class) and late CL-class Mercedes which came installed with unique convex lug bolts (Mercedes # 000 990 5407).

Mercedes # 000 990 5407



H.C.B-A1622

NEW

BENZ (W221) REAR SUBFRAME FRONT/REAR BUSH REMOVAL/ INSTALLATION TOOL KIT

BENZ (W221) 後工字樑前 / 後鐵套拆裝工具組



- This tool kit is used on removal/installation of Mercedes- Benz subframe front/rear bush.
- Application: Mercedes-Benz W221, W216
- This tool kit allows bushes changing on car.

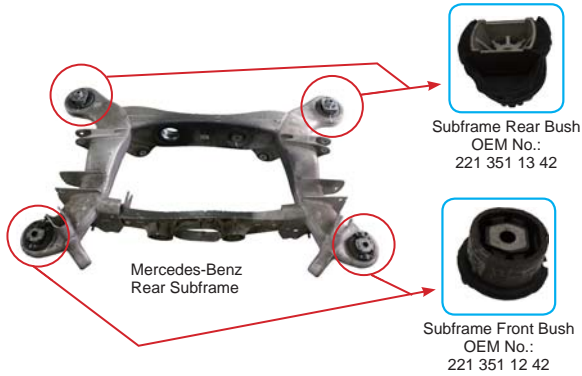

A.Subframe Front Bush Removal/Installation

a.Front Bush Removal:



b.Front Bush Installation:



B.Subframe Rear Bush Removal/Installation

a.Rear Bush Removal:



b.Rear Bush Installation:



H.C.B-B1622

NEW

ON CAR

BENZ (W221) DIFFERENTIAL BUSH REMOVAL / INSTALLATION TOOL KIT

BENZ (W221) 差速器鐵套拆裝工具組



- The differential bush will be broken under continual wearing. It would increase the instability when driving and make driver feel uncomfortable. To maintain stability of the vehicle and cut down the risk. So replacement of the differential bush and rear sub-frame bush is needed.
- This tool is for replacement of differential bush and rear sub-frame bush
- On car maintenance.
- Application: BENZ (W221)

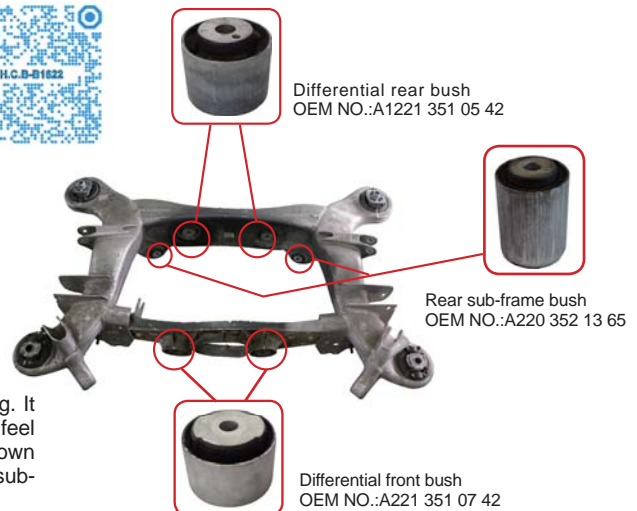



010
HWANG CHERNG BIN
Specialty Tools Inc.

賓士底盤修護工具
BENZ Chassis Repair Tool

H.C.B-A1624 **NEW** BENZ (W204) REAR SUBFRAME FRONT/REAR BUSH REMOVAL/INSTALLATION TOOL KIT

BENZ (W204) 後工字樑前 / 後鐵套拆裝工具



Subframe Front Bush

A204 351 08 42



Subframe Rear Bush

A204 350 01 75



- This tool kit is used on removal/ installation of the subframe front/ rear bush on car.
- Application: BENZ (W204)

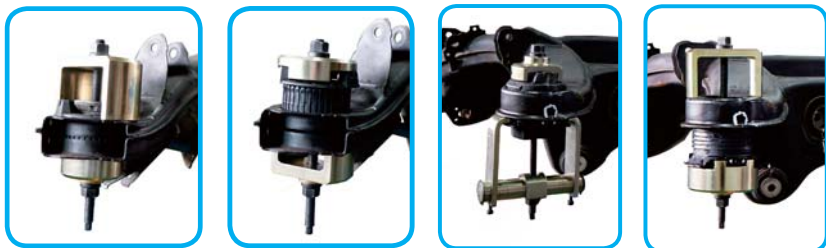

Benz Chassis

H.C.B-B1624 **NEW** BENZ (W204) DIFFERENTIAL BUSH REMOVAL / INSTALLATION TOOL KIT

BENZ (W204) 差速器鐵套拆裝工具組



Rear trailing arm bush no.:
A204 352 10 65



Differential bush no.:
A204 351 04 42

- The differential bushes will be broken due to the rain and long-term wearing, and finally make car unstable when driving. So, this kit can help you change differential bushes.
- This kit is designed to remove/install the differential bushes and rear trailing arm bushes.
- This kit can be operated on car
- Application: BENZ (W204)



010
HWANG CHERNG BIN
Specialty Tools Inc.

Benz Chassis



H.C.B-A1119

BENZ (W220) SEAL TOP AIR SUSPENSION STRUT PAT. M253505

BENZ (W220) 氣壓避震器油封更換工具

5 / 19.3 / 20.3 / 1.32'

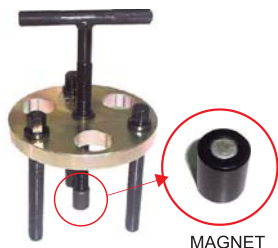

STEP 1



STEP 2



STEP 3



STEP 4

H.C.B-A1119-8

BENZ (W220) STRUT NUT SOCKET (OPTIONAL ACCESSORY)

BENZ (W220) 氣壓避震器油封更換套筒 (選購配件)

- To remove and install air suspension top strut nut.
- Application: BENZ W220.
- N.W.: 0.02 KG.



H.C.B-A1140

BENZ ML RV SUSPENSION BUSH REMOVAL/ INSTALLATION TOOL KIT PAT. 165163 USA PAT.

BENZ ML 休旅車工字樑拆裝工具組

5 / 13.1 / 14.5 / 1.59'



1



3



5



2



4



6

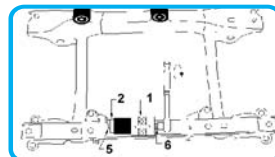

EXTRACTOR

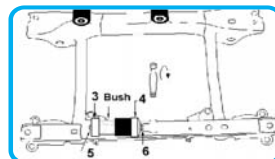

INSTALLER

H.C.B-A1147

BENZ SL DECAGON STAR-SHAPE SPECIAL SOCKET

H.C.B-A1148

BENZ SL 10 角星型特殊套筒

- BENZ SL triplet aluminum alloy steel ring extractor.
- A1147 combined with A1148 to be one set.



H.C.B-A1147 (8 mm)

H.C.B-A1148 (10 mm)



H.C.B-A1155 **ON CAR** **BENZ (W210/W202/W203/W140) REAR SUB-FRAME DIFFERENTIAL BUSH REMOVAL/INSTALLATION TOOL KIT USA PAT.**

BENZ (W210/W202/W203/W140) 差速器鐵套拆裝工具組

5 / 16.3 / 17.5 / 1.59'

- To remove and install the rear sub-frame differential metallic bush.
- Application: BENZ W210, W202, W203, W140
- Save the time and money for maintenance.



Genuine Stock No.:
A 129 351 2142

H.C.B-A1174 **ON CAR** **BENZ (W124/W129/W201) FRONT LOWER CONTROL ARM BALL JOINT REMOVAL/INSTALLATION TOOL KIT**

BENZ (W124/W129/W201) 前三角架
下控制臂球接頭拆裝工具

5 / 16.3 / 17.5 / 1.59'

- To remove and install lower ball joint on the wishbone.
- Application: BENZ W124/W129/W201.

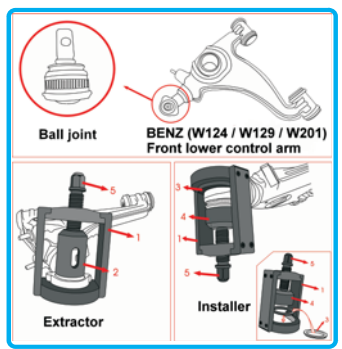

H.C.B-A1259 **BENZ DRAG LINK PULLER**

BENZ 中段拉桿球接頭拆卸器

20 / 20.8 / 24 / 2.6'

- Puller for ball joint of drag link.
- Application: W123, W124 (except 124.2/3) up to 1.6.89, W126, W201, W202, W140.



H.C.B-A2136 **BENZ (W163/W164) M-CLASS PIN WRENCH SOCKET (Dr. 3/4")**

BENZ (W163/W164) (ML) 休旅車羊角下球接頭拆裝套筒 (Dr. 3/4")

20 / 10.6 / 12 / 0.07'

- This secure the retaining ring during R&R of ball joints.
- Application: MERCEDS-BENZ W163/W164 M-Class lower ball joint of front & rear axles.





010
HWANG CHERNG BIN
Specialty Tools Inc.

SINCE 1990

Benz Chassis



H.C.B-B2136

BENZ (W163/W164) M-CLASS PIN WRENCH SOCKET (Dr. 1/2")

BENZ (W163/W164) (ML) 休旅車羊角下球接頭拆裝套筒 (Dr. 1/2")

- To secure the retaining ring during R&R of ball joints.
- Application: MERCEDES-BENZ W163/ W164 M-Class lower ball joint of front & rear axles.

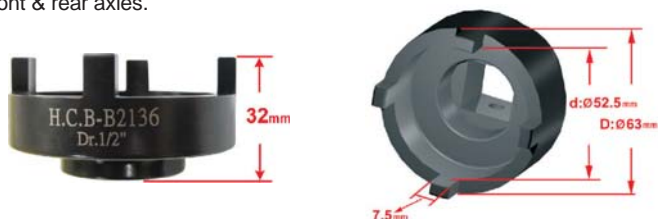

H.C.B-E1168

BENZ BALL JOINT REMOVAL/ INSTALLATION TOOL KIT (COMPREHENSIVE) PAT. M333280

賓士綜合型球接頭拆裝工具組 PAT. M333280

3 / 25 / 26 / 1.68'



- This kit is for BENZ (W220/W211/W230/W163/W164/W215) BALL-JOINT.
- A series for BENZ (W220/W211/W215/W230) BALL-JOINT.
- B series for BENZ (W220/W211) BALL-JOINT.
- D2 for removing BENZ (W163/W164) FRONT & REAR BALL-JOINT.
- W for installing BENZ (W163/W164/W215) FRONT & REAR BALL-JOINT.
- W need to be locked over 300°Nm.
- The C-clamp was forged, its material is SCM440 and hardness is HRC 38° - 42°
- On car maintenance
- This kit includes: A1168, B1168, D1168.

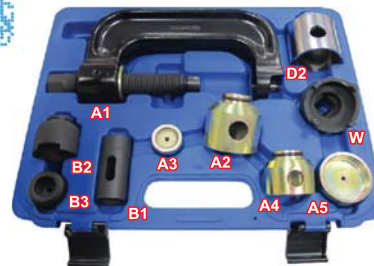

H.C.B-A1168

ON CAR

BENZ (W211/W215/W220/W230) BALL JOINT REMOVAL/ INSTALLATION TOOL KIT PAT. M333280

BENZ (W211/W215/W220/W230) 前下球接頭拆裝器 PAT. M333280

4 / 26 / 26.5 / 1.73'



- The C-clamp was forged, its material is SCM440 and hardness is HRC 38°~42°
- On car maintenance.
- Special design to remove & install the ball joint without removing any parts.
- Application: BENZ W211/W215/W220/W230

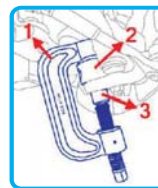

Extraction

Installation

H.C.B-B1168

ON CAR

BENZ (W220/W211) SUB-FRAME BALL JOINT REMOVAL/ INSTALLATION TOOL KIT PAT M.333280

BENZ (W220/W211) 後三角架球接頭拆裝工具組

- The C-clamp was forged, its material is SCM440 and hardness is HRC 38°~42°
- On car maintenance.
- Special design to remove & install the ball joint without remove any parts.
- Presses the ball joint into the steering knuckle on BENZ W220 & W211.
- N.W.: 4.72 KGS



Installation

Extraction

H.C.B-D1168 **ON CAR** **BENZ (W163/W164) BALL JOINT REMOVER PAT. M333280**

BENZ (W163/W164) 球接頭拆卸器

4 / 27.2 / 28.4 / 1.28'

- The C-clamp was forged, its material is SCM440 and hardness is HRC 38° - 42°
- On car maintenance.
- Remove the drive shaft before use this tool.
- Combine with H.C.B-A2136 while installing ball joint.
- Application: BENZ W163/W164.
- N.W.: 5.61 KGS



BUSH NUMBER : 032 060 035 012
032 060 042 012



H.C.B-A1318 **BENZ (W211/W221/W164) AIR SUSPENSION PIPING SOCKET**

BENZ (W211/W221/W164)
避震器高壓風管拆卸套筒

- Application: BENZ W211/W221/W164
- Special open design helps to remove the nut without taking away air suspension pipe.



H.C.B-A2292 **BRAKE CALIPER WIND BACK TOOL KIT (37 PCS)**

剎車分泵調整組 (通用型)

- Application: Renault, Citroen, Audi, BMW, Ford, Lancia, Proton, Rover, Volkswagen, Mini Cooper, Nissan, Saab, Honda, Alfa Romeo, Opel/Vauxhall auxhall, Subaru, Mazda, Mitsubishi, Volvo, iat, Mercedes-Benz.
- Left and right hand threaded wind back tools.
- Includes 30 adaptors and 5 reaction plates.



H.C.B-A2017 **UNIVERSAL CALIPER WIND BACK KIT**

碟式分泵調整組 (通用型)

10 / 14.5 / 15.5 / 1.55'

- Winds back brake piston for replacing brake pads.
- Application: BENZ, BMW, OPEL, FORD, NISSON, (CEFIRO), TOYOTA, GM, most of cars.

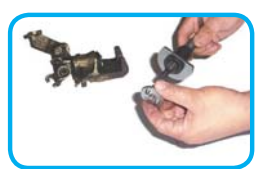

STEP1



STEP2



STEP3

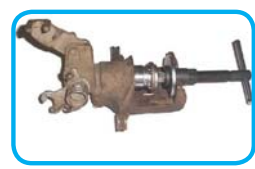

STEP4



010
HWANG CHERNG BIN
Specialty Tools Inc.

SINCE 1990

Benz Chassis



H.C.B-A2117

18 PCS UNIVERSAL CALIPER WIND BACK KIT

18 PCS 煞車分泵調整組 (通用型)

12-L

12-R

8 / 18.72 / 20.6 / 1.31'

- Application :
- Material: S45C
- Hardness: 38° ~ 43°



- (1) Plate
- (2) CITROEN/XM, XANTIA.(F/R)
- (3) AUDI(F). FIAT/ALFA ROMEO(F). FORD/FIESTA(F),ISUZU(F). HONDA/CONCERTO(F). JAGUAR/XJ6, XJ40 (F/R) BMW/318IS, 320I, 325TD, 518i, 525i & LX, 740i, 850Ci, M5(F). MERCEDES BENZ/190, 200, 300, 420,560 SERIES(F). MITSUBISHI/COLT(F). NISSAN/MLERA STANZA, SUNNY(F). ROVER/AUSTIN, METRO, 200 & 400 SERIES, MAESTRO, MONTEGO(F). TOYOTA/CAMRY(F). VOLVO(F). VW/PASSAT, GOLF GTI(F)
- (4) Ford Australia/NZ Telstra, Laser(R). MAZDA(R). SAAB 9000(R). IAT/ALFA ROMEO 164 2.0(R). HONDA/PRELUDE, CRX 16i, GM/SATURN(R).
- (5) Dr. 3/8" adapter is used with extension bar and ratchet when need to apply more strength to the piston.
- (6) NISSAN, PRIMERA, VW/GOLF IV.
- (7) AUDI/80, 90, V8+100, COUPE E(R). ROVER/800 ABS. SUBARU L+Z(R). FORD/SIERRA ABS, GRANADA, S CORPIO ABS 85(R). NISSAN/BLUEBIRD 1.8 TURBO, SILVIA TURBO PRIMERA 2.0i LS/GS/GSX(R). PEUGEOT/405 1.9GI, GRI, SRI, GTXI, MI 16, 605 2.0 SRI(R). TOYOTA/CELICA, COROLLA GT, MR2(R). VW/GOLF GTI, JETA SYNCHRO, JETTA GTI 16V, PASSAT CL, GL, GT AND GT 16V, CORRADO 16VSCIRROCA GTX 16V(R).
- (8) GM most 1-7/8" diameter pistons.
- (9) GM most 2-1/8" diameter pistons.
- (0) GM most 2-1/2" diameter pistons.
- (A) RENAULT/R21, LAGUNA (REAR DISK). (M)FORD MONDEO. MINI COOPER/MAZDA 3 (N)SAAB. FORD METROSTAR HONDA. (F)OPEL (REAR DISK) (K)CITROEN (E)NISSAN MAXIMA

H.C.B-A2135

UNIVERSAL AIR POWERED DISC CALIPER WIND BACK KIT

氣壓碟刹分泵回復器

5 / 15.3 / 16.2 / 2.02'



1. Air Adjusting Lever
2. Citroen/XM, Xantia. (F/R)
3. Audi(F). FIAT/Alfa Romeo(F). Ford/Fiesta(F). Isuzu(F). Honda/Concesto(F). Jaguar/XJ6, AJ40(F/R). BMW/318is, 320i, 325TD, 518i, 525i & 1x, 740i, 850ci, M5.(F). Mercedes Benz/190, 200, 300, 420, 560 series(F). Mitsubishi/Colt(F). NISSAN/Mlera, Stanza, Sunny(F). Rover/Austin, Metro, 200 & 400 series, Maestra, Montego(F). TOYOTA/Camry(F). Volvo(F). VW/Passat, Golf GTI(F).
4. FORD Australia/NZ Telstar, Laser(R). MAZDA(R). SAAB 9000(R). FIAT/Alfa Romeo1642.0(R).HONDA/Preluda, CRS 16i, GM/Saturn(R). GM/Grand Prix, Lumina.
5. Dr. 3/8" Adapter used with extention bar and ratchet when need to apply more strength to the piston.
6. NISSAN, PRIMERA, VW/Golf 1V.
7. Audi/80, 90, V8+100, CoupeE(R). Rover/800ABS. SUBARUL + Z(R). FORD/Sierra ABS, Granada, Scorpio ABS 85 (R). NISSAN/Bluebird 1.8 Turbo, Silvia Turbo, Primera2.0i LS/ GS/GSX(R). PEUGEOT/405 1.9Gi, Gri, Sri, Gtxi, MI 16, 605 2.0 Sri(R). TOYOTA/Celica, Corolla GT, MR2(R). VW/Golf Gti, Jeta Synchro, Jetta Gti 16v, Passat CL, GL. GT and GT 16v, Corrado 16v scirroca GTX 16V(R).
- 8 GM most 1-7/8" diameter pistons.
9. GM most 2-1/8" diameter pistons. (CADI Seville/Eldorad 80-85)
- 10.GM most 2-1/2" diameter pistons.(Seville/Eldored 79).
 - A. Renault/R21, Laguna (Rear Disk).
 - M. Ford Motors, MINI/ R68,MAZDA 3
 - N. SAAB. Honda. Alfa Romeo AUDI, VW,Lancia
 - E. NISSAN Maximias.
 - F. Opel (Rear disk)
 - K. Citroen





010
HWANG CHERNG BIN
 Specialty Tools Inc.

賓士底盤修護工具
BENZ Chassis Repair Tool

H.C.B-A2174 **21 PCS UNIVERSAL BRAKE CALIPER WIND BACK KIT**

21 PCS 煞車分泵調整組 (通用型)

10 / 25.5 / 26.5 / 1.87"

- 1-1: RIGHT HAND HELIX BOLT, application: General Car
- 1-2: LEFT HAND HELIX BOLT, application: VW, NISSAN (CEFIRO)
- 2: Citroen/XM, Xantia. (F/R)
- 3: Audi (F). FIAT/Alfa Romeo (F). Ford/Fiesta (F). ISUZU(F). HONDA/Concesto(F). Jaguar/XJ6,XJ40(F/R).BMW/318is,320i,325TD,518i,525i & 1x,740i,850ci,M5.(F). Mercedes Benz/190, 200, 300, 420, 560 series (F). Mitsubishi/Colt (F). NISSAN/Mlerra, Stanza, Sunny(F).Rover/Austin, Metro,200 & 400 series, Maestra, Montego(F).TOYOTA/Camry(F). Volvo (F). VW/ Passat, Golf GTI (F).
- 4: FORD Australia/NZ Telstar, Laser(R). MAZDA(R). SAAB 9000 R). FIAT/Alfa Romeo 1642.0(R).HONDA/Prelude, CRS 16i, GM/Saturn(R).GM/Grand Prix,Lumina.
- 5: 3/8" dr. Adapter used with extention bar and ratchet when need to apply more strength to the piston.
- 6: NISSAN, PRIMERA, VW/Golf IV.
- 7: Audi/80,90,V8+100, Coupe E(R). Rover/800 ABS. SUBARU L+Z(R). FORD/Sierra ABS, Granada, Scorpio ABS 85(R). NISSAN/Bluebird 1.8 Turbo, Silvia Turbo, Primera 2.0i LS/GS/GSX(R). PEUGEOT/405 1.9Gi,Gri, Sri, Gtxi, MI 16,605 2.0 Sri(R). TOYOTA/Celica, Corolla GT,MR2(R).VW/Golf Gti, Jeta Synchro, Jetta Gti 16v, Passat CL, GL ,GT and GT 16v, Corrado 16V scirroca GTX 16V(R).
- 8: GM most 1-7/8" diameter pistons.
- 9: GM most 2-1/8" diameter pistons. (CADI Seville/Eldorad 80-85).
- 0: GM most 2-1/2" diameter pistons. (Seville/Eldored 79).
 - A: Renault/R21, Laguna (Rear Disk).
 - M: Ford Motors Mini Cooper.
 - N: SAAB. Honda.
 - F: Opel (Rear disk)
 - E: NISSAN Maximas.
 - K: Citroen
 - K1: Citroen
 - K2: Citroen



H.C.B-A1446 **BENZ (W211/W221/W215/W219/W220/W230) BALL JOINT SEPARATOR TOOL (HYDRAULIC) (10 TONS)**

BENZ (W211/W221/W215/W219/W220/W230) 球接頭工具 (油壓)(10 噸)



- Puller for track control arm and radius rod at stub axle assembly joints (used with hydraulic press)
- Application: BENZ (W211/W221/W215/W219/W220/W230)
- **BENZ OEM no. ref.:** 220-589-00-33-00



010
HWANG CHERNG BIN
 Specialty Tools Inc.

SINCE 1990

Benz Chassis



H.C.B-A1535

BENZ (164.122/125/175/177/186/822/825/871) FREE WHEELING ADAPTER

BENZ (164.122/125/175/177/186/822/825/871) 自由輪輔助器

H.C.B-B1535

BENZ&BMW FREE WHEELING ADAPTER

BENZ&BMW 自由輪輔助器

FREE WHEELING ADAPTER

- The free wheeling mechanism is used for transporting vehicles with failed ISM.
- Raise vehicle (on lift or using vehicle jack) and remove either the left or right rear wheel.
- Install the free wheeling adapter to the rear axle of the vehicle with the five supplied Allen screws and tighten to a torque of 80Nm
- Mount the original vehicle wheel to the free wheeling adapter using the original wheel bolts and torque to 80 Nm
- With the free wheeling adapter installed, the vehicle can now be rolled to a desired location or onto a flatbed vehicle transporter without any difficulty

H.C.B-A1535

BENZ FREE WHEELING ADAPTER



H.C.B-B1535

BENZ&BMW FREE WHEELING ADAPTER



H.C.B-A1535

- Application: BENZ Model 164.122/125/175/177/186/822/825/871
Model 251.122/125/165/175/177/W221
- BENZ OEM no. ref.: 164 589 03 63 00

H.C.B-B1535

- Application:
BENZ Model : 164.122/125/175/177/186/822/825/871/251.122/125/165/175/177/W221
BMW Model : F01.F02.F07.F10.F11.F12.F13.F25.F30.F31.F32.F33.F34

H.C.B-C2189

BENZ M & R-CLASS BRAKE CALIPER WIND BACK SOCKET (1/2", 78 mm, H11)

BENZ M & R-CLASS 煞車分泵拆卸套筒 (1/2", 78 mm, H11)

- Size: Dr. 1/2" x H11
- Length: 78 mm
- Application: MERCEDES-BENZ M & R-CLASS
- Special designed to replace the brake lining.



H.C.B-A2189

MERCEDES-BENZ M & R-CLASS BRAKE CALIPER WIND BACK SOCKET (H9)

BENZ M & R-CLASS 煞車分泵拆卸套筒 (H9)

- Dimensions: D: 25 mm, Length: 78 mm, Dr. 1/2", Hex. 9
- Application: MERCEDES-BENZ M & R Class, BENZ W163, W164, W251.



Dr. 1/2" ←

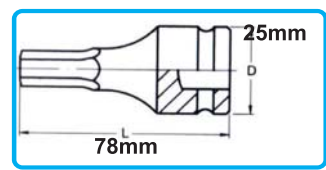

H.C.B-A1369

BENZ SPRINTER REAR AXLES SOCKET

BENZ SPRINTER 後羊角套筒

- Application: BENZ Sprinter



H.C.B-A1377

BENZ SPRINTER, VW LT BALL JOINT REMOVER (35 mm) PAT. M 362085

BENZ SPRINTER, VW LT 球接頭拆卸器 (35 mm)

- The ball joint remover has a ball bearing pressure peak which can be used with an impact wrench. With the pressure and impact moment great, loosening torque is achieved.
- Application: Mercedes Benz Sprinter, BMW (E70) and VW LT for loosening the very tight suspension ball joint at the front suspension.

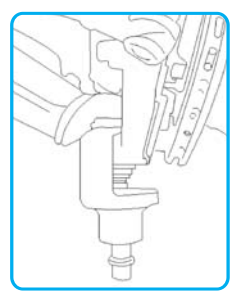



H.C.B-A2155

DRIVE SHAFT SPECIAL SOCKET KIT (Dr. 1/2") (5 PCS)

傳動軸專用套筒組 (Dr. 1/2") (5 PCS)

9 / 22.5 / 24 / 1.64'

Double-Hexagon (12 points) sockets are for gearboxes, differentials, and front & back axles.



A2155-032 32mm 12-Points Socket

Applicable: Fiat Punto, Ford Escort, Mondeo, Mercedes W140, Nissan Almera, Opel Astra H, Vivaro, Subaru Outback etc.

Drive	Size	Length(mm)	Weight(g)
1/2"	32	75	404



A2155-030 30mm 12-Points Socket

Applicable: BMW E36, E46, Citroen Saxo, Ford Galaxy, Mercedes W123, W124, W126, W129, W201, W203, W211, Opel Astra F, Astra G, Renault Scenic, Clio, Kangoo, Toyota Avensis, Picnic und VW Golf III, Golf IV, Lupo, Touareg, T5 etc.

Drive	Size	Length(mm)	Weight(g)
1/2"	30	75	328



A2155-034 34mm 12-Points Socket

Applicable: Fiat Marea, Lancia Lybra, Renault etc.

Drive	Size	Length(mm)	Weight(g)
1/2"	34	75	436



A2155-035 35mm Hexagon Socket

Applicable: Peugeot 307, 407, 806 etc.

Drive	Size	Length(mm)	Weight(g)
1/2"	35	75	474



A2155-036 36mm 12-Points Socket

Applicable: Audi, BMW E36, E39, X5, Ford Transit, Seat Ibiza, Cordoba, Nissan Primera, VW Polo, Golf V, Touareg etc.

Drive	Size	Length(mm)	Weight(g)
1/2"	36	75	536

H.C.B-B2155

DRIVE SHAFT SPECIAL SOCKET KIT (Dr. 1/2") (6 PCS)

傳動軸專用套筒組 (Dr. 1/2") (6 PCS)



B2155-024 24mm 12-Points Socket

Applicable: VW GOLF (VI,VII), Scirocco, Tiguan, Touran, Passat(3C),Passat CC,Audi A3,TT : Seat Leon, Altea · Skoda Octavia(1Z), Super B(3T) etc

Drive	Size	Length(mm)	Weight(g)
1/2"	24	75	480



A2155-030 30mm 12-Points Socket

Applicable: BMW E36, E46, Citroen Saxo, Ford Galaxy, Mercedes W123, W124, W126, W129, W201, W203, W211, Opel Astra F, Astra G, Renault Scenic, Clio, Kangoo, Toyota Avensis, Picnic und VW Golf III, Golf IV, Lupo, Touareg, T5 etc.

Drive	Size	Length(mm)	Weight(g)
1/2"	30	75	328



A2155-036 36mm 12-Points Socket

Applicable: Audi, BMW E36, E39, X5, Ford Transit, Seat Ibiza, Cordoba, Nissan Primera, VW Polo, Golf V, Touareg etc.

Drive	Size	Length(mm)	Weight(g)
1/2"	36	75	536



A2155-034 34mm 12-Points Socket

Applicable: Fiat Marea, Lancia Lybra, Renault etc.

Drive	Size	Length(mm)	Weight(g)
1/2"	34	75	436



A2155-032 32mm 12-Points Socket

Applicable: Fiat Punto, Ford Escort, Mondeo, Mercedes W140, Nissan Almera, Opel Astra H, Vivaro, Subaru Outback etc.

Drive	Size	Length(mm)	Weight(g)
1/2"	32	75	404



A2155-035 35mm Hexagon Socket

Applicable: Peugeot 307, 407, 806 etc.

Drive	Size	Length(mm)	Weight(g)
1/2"	35	75	474



010
HWANG CHERNG BIN
Specialty Tools Inc.

賓士底盤修護工具
BENZ Chassis Repair Tool

H.C.B-D2155-27 **NEW** DRIVE SHAFT SPECIAL SOCKET (12 POINT , SW 27 mm)

傳動軸專用套筒 (12 角 , SW 27 mm)

- Size: Dr. 1/2" , 27 mm



H.C.B-D2155-31 **NEW** DRIVE SHAFT SPECIAL SOCKET (12 POINT , SW 31 mm)

傳動軸專用套筒 (12 角 , SW 31 mm)

- Size: Dr. 1/2" , 31 mm



Benz Chassis

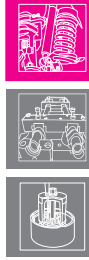



010

HWANG CHERNG BIN
Specialty Tools Inc.

賓士引擎修護工具

BENZ ENGINE REPAIR TOOL





010
HWANG CHERNG BIN
 Specialty Tools Inc.

賓士引擎修護工具
 BENZ Engine Repair Tool

H.C.B-A1468 **BENZ & BMW GUIDE RAIL PIN SLIDE HAMMER PULLER KIT**

BENZ & BMW 內鍊滑板插銷倒盾拉拔器組

■ This set comes with the following:

Parts No.	Description	OEM NO.
A1468-1	Rail Pin Puller Slide Hammer	116 589 20 33 00
A1468-2	Threaded Bolt (M8x150L)	616 589 00 34 00
A1468-3	Threaded Bolt (M6x150L)	116 589 02 34 00
A1468-4	Threaded Bolt (M10x100L)	116 589 03 34 00
A1468-5	Threaded Bolt (M6x100L)	102 589 00 34 00
A1468-6	Threaded Bolt (M8x50L)	616 589 00 34 00
A1468-7	Threaded Bolt (M6x50L)	116 589 01 34 00
A1468-8	Camshaft Sprocket et Pin (M24xP1.5)	156 589 00 34 00



Needed for the proper extraction of rail pins from cylinder head while out of the car.

- Impact extractor for guide rail bolts (basic equipment).
- Application: M102.92 /93 /96 /98, 103, 104, 110/92 /98 /99, 111, 116, 117, 119, 120, 155, 272, 275, 285, 601, 602.91 /93 /94 /96, 603.91 /93 /96 /97, 602.983, 615, 616, 617.91 /95, 606, 602.981, 612.965, 628, 640, 642

H.C.B-A1016 **BENZ & BMW GUIDE RAIL PIN PULLER**

BENZ & BMW 內鍊滑板插銷拔卸器

- It can remove the most stubborn pins from the cylinder head. This puller incorporates a thrust bearing to ease the pulling action.
- The overall length is 85 mm, which long enough to reach the problem areas.
- This alloy steel heat treated tool has already been tested in shops and has proven to be the best solution.
- Application: BENZ model M102, M110, M115, M116, M117, M130, OM601, OM602, OM 603, OM 615, OM616 & OM617.
- Screw specification: M8 x P1.25 x M6 x P1.0 x 1 PCS
M8 x P1.25 x 30 mm x 1 PCS
- N.W.: 0.26 KG

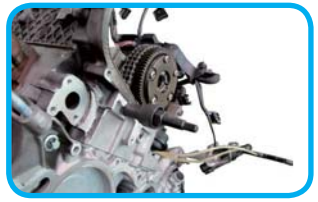

H.C.B-A1017 **BENZ (W210) FUEL TANK LID REMOVER / INSTALLER**

BENZ (W210) 塑膠汽油箱蓋拆裝工具

- This tool is used for removing and installing the plastic fuel tank lid.
- Application: BENZ W210
- N.W.: 0.1 KG



H.C.B-A1039 **BENZ (W202) FUEL TANK LID REMOVER /INSTALLER**

BENZ (W202) 塑膠汽油箱蓋拆裝特種工具

30 / 25.2 / 27.4 / 1.41'

- The special tool is used for removing and installing the plastic fuel tank cup.
- Application: BENZ W202



Benz Engine





010
HWANG CHERNG BIN
Specialty Tools Inc.

Benz Engine



H.C.B-A1240 BENZ / BMW / VW FUEL TANK LID REMOVER / INSTALLER

BENZ / BMW / VW 塑膠汽油箱蓋拆裝器

- For removing and installing the plastic fuel tank lid.
- Application: BENZ W163/ W203/ W211, BMW E36/ E46, VW, AUDI
- BENZ OEM no. ref.: 203-589-01-07-00



H.C.B-A1379 BENZ (W204 / W212), BMW (F10) FUEL TANK LID REMOVER / INSTALLER

BENZ (W204 / W212), BMW (F10) 汽油油箱蓋拆裝器

- The tool is used for removing and installing the metal fuel tank lid.
- Application: BENZ W204/ W212, BMW F10, SAAB(93)



H.C.B-A1399 BENZ (W164 / W251) FUEL TANK LID WRENCH (Dr. 1/2" , 22 POINTS)

BENZ (W164 / W251) 汽油浮筒拆裝器 (Dr. 1/2", 22 角)

- Fuel delivery slotted wrench for lock ring on fuel pump/sending unit.
- Application: Benz M-Class W164 from 2005-2011 and R-Class W251 Chassis.

Dr.1/2"

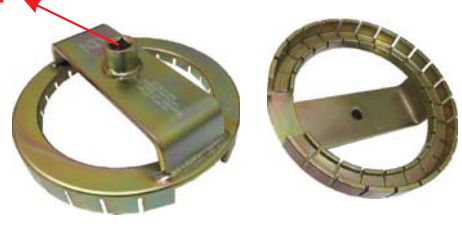

H.C.B-A1022 BENZ & BMW FAN SERVICE WRENCH KIT (8 PCS)

BENZ & BMW 專用風扇扳手組 (8 PCS)

5 / 24.8 / 25.8 / 1.9'

- The hardest material, S45C & heat treated.
- Shiny surface treatment, just like mirror.
- The best quality in the field.



- (A) BMW VISCOUS FAN NUT WRENCH (32mm) BMW風扇扳手 (32mm)
- (B) BMW PULLEY HOLDER BMW風扇支撐扳手(雙頭)
- (C) MERCEDES-BENZ FAN CLUTCH WRENCH (65mm) BENZ風扇支撐扳手 (65mm)
- (D) BENZ REACTION WRENCH WITH 3HOLES (Ø10.3) BENZ風扇支撐扳手 (三孔) (Ø10.3)
- (E) BENZ VISCOUS FAN NUT WRENCH (36mm) BENZ風扇扳手 (36mm)
- (F) BENZ HOLDING TOOL (L TYPE) BENZ風扇支撐扳手 (L型)
- (G) BENZ FAN BELT SERVICE WRENCH BENZ風扇支撐扳手
- (H) BENZ REACTION WRENCH WITH 3 HOLES (Ø11.7) BENZ風扇支撐扳手 (三孔) (Ø11.7)

H.C.B-A1022(A) BMW VISCOUS FAN NUT WRENCH (32 mm)

BMW 風扇扳手 (32 mm)

- Remove lock nuts on thermo-viscous fans found on FORD, BMW ...etc.
- N.W.: 0.42 KG
- Length: 383 mm
- Hardness: HRC 40°~45°



H.C.B-A1022(B) BMW PULLEY HOLDER

BMW 風扇支撐扳手 (雙頭)

- Allow the technician to hold the water pump pulley in place while loosening the radiator fan.
- N.W.: 0.38 KG
- Length: 400 mm
- Hardness: HRC 40°~45°



H.C.B-A1022(C) MERCEDES-BENZ FAN CLUTCH WRENCH (65 mm)

BENZ 風扇扳手 (65 mm)

- Special open-ended spanner allows removal and replacement the radiator fan hub.
- Application: MERCEDES engines M103 (6-cylinder), M104 (6-cylinder 4-valve), M119 (8-cylinder 4-valve), M120 (12-cylinder 4-valve).
- N.W.: 0.5 KG
- Length: 395 mm
- Hardness: HRC 40°~45°



H.C.B-A1022(D) BENZ REACTION WRENCH WITH 3 HOLES (Ø 10.3)

BENZ 風扇支撐扳手 (3 孔) (Ø10.3)

- Required to remove the radiator fan hub.
- The reaction spanner is bolted to the front face of the hub. The Poly-V belt is not in place and can not be used to lock the hub.
- Use for viscous fan.
- Application: MERCEDES C- and E-class engines M111 (4-cylinder 4-valve), OM604 OM605 and OM606. Slim handle for tight space operation.
- N.W.: 0.45 KG
- Length: 410 mm
- Hardness: HRC 40° ~ 45°



H.C.B-A1022(E) BENZ VISCOUS FAN NUT WRENCH (36 mm)

BENZ 風扇扳手 (36 mm)

- For undoing the retaining bolt on MERCEDES radiator fans.
- Application: MERCEDES engines M111, OM604, OM605 and OM606 (C- and E-class).
- N.W.: 0.68 KG
- Length: 343 mm
- Hardness: HRC 40°~45°



H.C.B-A1022(F) BENZ HOLDING TOOL (L TYPE)

BENZ 風扇支撐扳手 (L 型)

- To remove of the VISCO-coupling on the cooling fan.
- Application: MERCEDES engines M103 M104
- N.W.: 0.08 KG
- Length: 282 mm
- Hardness: HRC 40°~45°



H.C.B-A1022(G) BENZ FAN BELT SERVICE WRENCH

BENZ 風扇支撐扳手

- This universal tool is designed for servicing MERCEDES-BENZ, NISSAN quest mercury villager radiator fans and pulley belts. The three-in-one design allows servicing three separate areas of repair all of which require a specialty tool due to their confined locations.
- This special wrench can be used for loosening the A/C idler pulley tensioner lock-nut for A/C belt adjustment or replacement 8 mm & 10 mm bit included.
- N.W.: 0.7 KG
- Length: 489.5 mm



H.C.B-A1022(H) BENZ REACTION WRENCH WITH 3 HOLES (Ø 11.7)

BENZ 風扇支撐扳手 (3 孔) (Ø11.7)

- For electric-suction fan.
- For holding fan pulley while loosening or tightening screws on viscosity fan coupling.
- Application: M112, 113, 119, 985 (1996-2003)

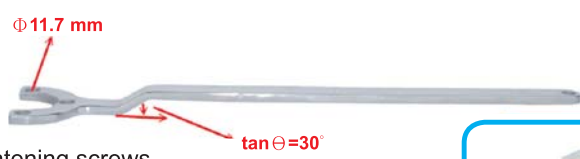



010
HWANG CHERNG BIN
 Specialty Tools Inc.

賓士引擎修護工具
 BENZ Engine Repair Tool

H.C.B-A1022(I) **NEW** **VW/AUDI FAN CLUTCH WRENCH (46 mm)**

VW/AUDI 風扇扳手 (46 mm)

- The hardest material, S45C, and heat treated.
- Shiny surface treatment, just like mirror.
- The best quality in the field.
- For holding fan pulley while loosening or tightening screws on viscosity fan coupling.
- Application: VW / AUDI



H.C.B-A1058 **BENZ (M111 / M112) CRANKSHAFT PULLEY HOLDER**

BENZ (M111 / M112) 曲軸支撐扳手

10 / 18 / 21 / 2.38'

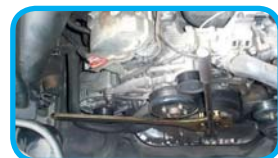

- Suitable for BENZ M111, M112 break loose the crankshaft pulley and harmonic balancer bolt.
- Designed to properly secure the pulley from rotating during R&R of crank bolt. The 50 mm hexagon head armature slips past the lightest of spaces and slides right into the center slot on the pulley. Then slide the long bar onto the receiving end of the armature and lock into position with the securing bolt.

H.C.B-A1099 **BENZ (M112 / M113 / M137) CRANKSHAFT HARMONIC BALANCER PULLEY HOLDER**

BENZ (M112 / M113 / M137) 曲軸支撐扳手

6 / 18.7 / 20.6 / 1.06'



- For removing and replacing the crankshaft bolt of M112 and M113 and M137, as found on E320, E430 ... etc.

H.C.B-B1099 **BENZ (M112 / M113 / M137) CRANKSHAFT HARMONIC BALANCER PULLEY HOLDER**

BENZ (M112 / M113 / M137) 曲軸支撐扳手

- For removing and replacing the crankshaft bolt of M112, M113 & M137, as found on E320, E430... etc.

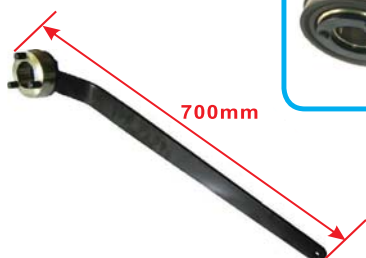

Genuine stock No.:
A 137 035 02 00



New Type of
H.C.B-B1099

H.C.B-C1199 **BENZ (M271) CRANKSHAFT HARMONIC BALANCER PULLEY HOLDER**

BENZ (M271) 曲軸支撐扳手 (A 271 030 00 03)

- For removing and replacing the crankshaft bolt.
- Application: BENZ (M271)



Benz Engine



H.C.B-A1199 BENZ (M271) CRANKSHAFT HARMONIC BALANCER PULLEY HOLDER

BENZ (M271) 曲軸支撐扳手 (A 271 030 00 03)

- To remove and replace the crankshaft bolt.
- Application: BENZ (M271)

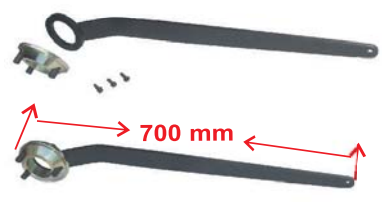

H.C.B-B1199 BENZ (M271) CRANKSHAFT HARMONIC BALANCER PULLEY HOLDER

BENZ (M271) 曲軸支撐扳手 (A 271 030 00 03)

- For removal and replacement of the crankshaft bolt.
- Application: BENZ (M271)
- BENZ OEM no. ref.: A 271 030 00 03

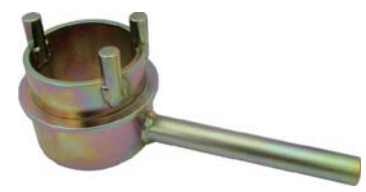

H.C.B-A1260 BENZ (642) CRANKSHAFT HUB LOCKING TOOL

BENZ (642) 曲軸支撐扳手

NO	Chassis No	Model	Engine Type
1	W203.020	C320 CDI	642.910
2	W203.220	C320 CDI	642.910
3	W209.320	CLK320 CDI	642.910
4	W209.420	CLK321 CDI Cabrio	642.910
5	W219.322	CLS320 CDI	642.920
6	W211.220	E280 CDI	642.920
7	W211.020	E280 CDI	642.920
8	W211.620	E280 CDI	642.920
9	W211.022	E320 CDI	642.920
10	W211.222	E320 CDI	642.920
11	W211.024	E320 CDI BLUETEC	642.920
12	W211.084	E280 CDI 4 MATIC	642.921
13	W211.284	E280 CDI 4 MATIC	642.921
14	W211.089	E320 CDI 4 MATIC	642.921
15	W211.289	E320 CDI 4 MATIC	642.921
16	W204.022	C320 CDI	642.960
17	W204.089	C320 CDI 4MATIC	642.961
18	W204.289	C320 CDI 4MATIC	642.961



H.C.B-A1326 BENZ (M272 / M273) CRANKSHAFT PULLEY HOLDING TOOL

BENZ (M272 / M273) 曲軸支撐扳手

6 / 24 / 25 / 2.65'

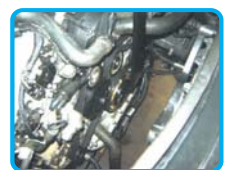

- Removal and replacement of the crankshaft bolt.
- Application: BENZ (M272/M273)





010
HWANG CHERNG BIN
 Specialty Tools Inc.

賓士引擎修護工具
 BENZ Engine Repair Tool

H.C.B-B1326 BENZ (M272 / M273) CRANKSHAFT PULLEY HOLDING TOOL

BENZ (M272 / M273) 曲軸支撐扳手

- For the removal and replacement of the crankshaft bolt.
- Application: BENZ (M272/M273)



H.C.B-A1266 ADJUSTABLE UNIVERSAL CRANKSHAFT PULLEY HOLDING TOOL USA PAT.7069821 TW PAT.227176

專利可調式皮帶盤支撐扳手

4 / 22.6 / 23.7 / 2.37'

- Adjustable distance: P.C.D 30 mm ~ 150 mm
- Material: SCM440 (Forging)
- This tool is designed for holding the crankshaft only.
- Application: BENZ S600, M137, M112, M113, M271, M642, CEFIRO A32, A33 and most kinds of engine

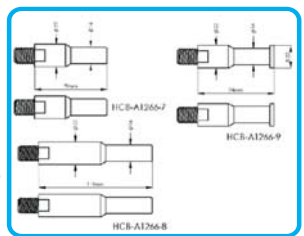

H.C.B-A1268 BENZ (M112/M113/M272/M273) AIR CONDITIONING COMPRESSOR PULLEY HOLDING TOOL

BENZ (M112/M113/M272/M273) 冷氣壓縮機皮帶盤支撐扳手

- Use H7 socket when repairing M272.
- Application: Benz Engine M112.113.272.273
- Counter holder for fixing in place and unfastening the belt pulley on the air condition compressor.
- N.W.: 0.51 KG



H.C.B-A1028 BENZ (M102 / M103) VALVE SPRING COMPRESSOR

BENZ (M102 / M103) 免拆式汽門彈簧壓縮組

4 / 12.2 / 14 / 1.2'

- For R&R of valve spring.
- No need to remove cylinder head.
- Application: BENZ (M102 / M103)

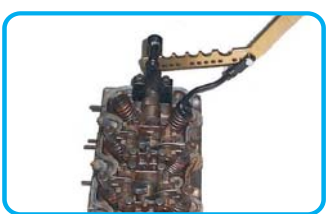

Benz Engine

H.C.B-A1267 BENZ VALVE SPRING COMPRESSOR

BENZ 汽門彈簧壓縮棒

- To compress valve springs for replacement of seals, stems, or valves on pre 1991 six cylinder (except 110) and eight cylinder engines through 1991.
- Valve Spring Compressor Tool used for the proper R & R of valve spring or rocker arm. Job can be done with the cylinder head on or off the car.
- Application: M114, 115, 116, 117, 130, 180.
- N.W.: 0.95 KG

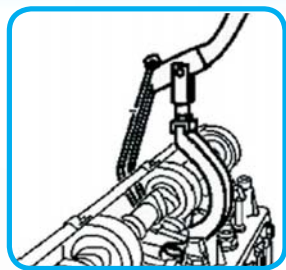

H.C.B-A1074 WEDGE KIT

BENZ 門板拆卸器

- Material : Polyamide (聚醯胺纖維)

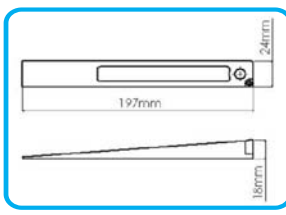

H.C.B-A1074-1 HANDY REMOVER

塑鋼撬棒

- Material : Polyamide (聚醯胺纖維)
- To remove the wood & plastic pieces on the door panels safely as well as on the dashboard, without damaging it.
- Application: all MERCEDES-BENZ.

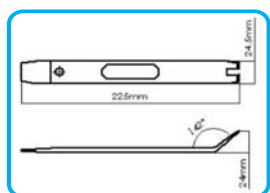

H.C.B-A1074-2 HANDY REMOVER

塑鋼撬棒

- Material : High density polyethylene (聚乙烯)

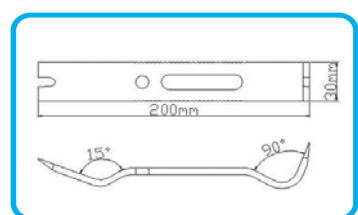



010
HWANG CHERNG BIN
 Specialty Tools Inc.

賓士引擎修護工具
 BENZ Engine Repair Tool

Benz Engine

H.C.B-A1074-3 REMOVER WIDE TYPE

塑鋼撬棒

- Material : High density polyethylene (聚乙烯)

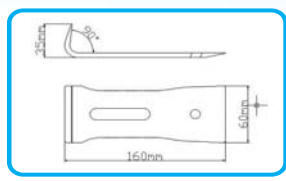

H.C.B-A1074-4 REMOVER PULL TYPE

塑鋼撬棒

- Material : High density polyethylene (聚乙烯)
- For plastic upholstery fasteners.
- Place tool under the edge of door panel and insert fastener as fast as possible, and then simply pry up.
- Large support area to protect clips and pad.

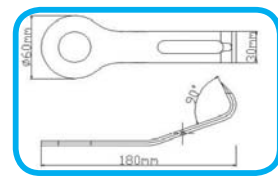

H.C.B-B1074

5 PCS HANDY REMOVER KIT
 5 PCS 塑鋼撬棒組



H.C.B-G1074

5 PCS HANDY REMOVER KIT
 5 PCS 塑鋼撬棒組



H.C.B-P1074

5 PCS HANDY REMOVER KIT
 5 PCS 塑鋼撬棒組



H.C.B-C1074 MERCEDES-BENZ WEDGE REMOVER KIT (3 PCS)

MERCEDES-BENZ 門板拆卸工具組 (3 PCS)



H.C.B-T1074 MERCEDES-BENZ WEDGE REMOVER KIT (3 PCS)

MERCEDES-BENZ 門板核桃木工具組 (3PCS)





010
HWANG CHERNG BIN
Specialty Tools Inc.

SINCE 1990

Benz Engine



H.C.B-A1103 BENZ (W140) DOOR PLANK EXTRACTOR

BENZ (W140) 門板核桃木工具

- Genuine stock No.: 140 589 16 6300R.



H.C.B-A1067 BENZ ASSEMBLY SLEEVE FOR IGNITION

BENZ 鎖頭外框套

12 / 14.7 / 15.7 / 1.53'

- For removing and replacing the ignition switch retaining ring.
- Application: BENZ 129,140,164,169,171,199, 202, (After Jane,1997), 203, 204, 208, 209, 210, 211, 215, 219, 220, 221, 230, 240, 245, 251, 414, 463 (After Dec ,2000), 906.



H.C.B-A1241 BENZ IGNITION LOCK REMOVER

BENZ 鎖頭拆卸器

- For turning the covering cap when removing / installing the locking cylinder on the ignition, and the glow plug starting switches.
- Application: W116, W123, W124, W126, W163, 129/140 (After June, 1995), 414, W170, W202, W210 etc.



H.C.B-A2233 RADIO DASHBOARD REMOVAL / INSTALLATION TOOL KIT (52 PCS)

儀錶板, 音響, 鎖頭, 拆裝工具組 (52 PCS)

- This set includes tools needed to install and remove after-market radios from a large variety of vehicle.
- This set is necessary when doing any radio repair or replacement.
- To avoid any radio or dashboard damaged, use the appropriate tool for the specific vehicle/radio.



H.C.B-C2003

RADIO REMOVAL TOOL KIT (20 PCS)

音響拆卸工具組 (20 PCS)



- Easily remove Car radio/CD players when dashboard removal is needed.
- For the removal of popular car stereos from Becker, Blaupunkt, Grundig, JVC and Pioneer systems.
- Ideal for Audi, BMW, Ford, Mercedes-Benz, Porsche, Skoda, Volkswagen.
- Application:
 - 4pc Radio Removal Keys(VW)
 - 2pc Radio Removal Keys(MERCEDES BENZ/PORSCHE)
 - 2pc Radio Removal Keys(VW/RENAULT/MERCEDES BENZ/ALPINE)
 - 2pc Radio Removal Keys(New SKODA)
 - 2pc Radio Removal Keys(New BECKER)
 - 2pc Radio Removal Keys(PIONEER)
 - 2pc Din Radio Removal U-Hooks(BLAUPUNKT/PEUGEOT/CLARION)
 - 1pc Allen Hex Wrench (BMW)
 - 2pc Din Radio Removal U-Hooks(ALFA/FIAT/FORD/VW/AUDI/BLAUPUNKT/RENAULT)
 - 1pc Special Pentagon Wrench(JVC/PIONEER)

H.C.B-A2003

BENZ DASHBOARD SERVICE TOOL KIT

BENZ 儀錶板, 音響, 鎖頭拆裝工具組

60 / 13.1 / 17.3 / 2.09'

- Includes ignition lock remover, radio set remover, and instrument cluster removing hooks.



H.C.B-B2003

BENZ DASHBOARD SERVICE TOOL KIT (10 PCS)

BENZ 儀錶板, 音響, 鎖頭拆裝工具組 (10 PCS)

48 / 17.9 / 18.9 / 3.5'

- 2 pcs removal hooks for instrument cluster on models W107, W116, W123, W124, W126, W140, and W201
- 2 pcs removal tools for ignition lock on model W126
- 2 pcs removal tools for ignition lock on models W124 & W201
- 4 pcs radio removal tools on models W129, W140, W202, and W210



H.C.B-A1072 BENZ (M271 / M272) OIL FILTER WRENCH (Dr. 1/2", 14 POINTS, 74 mm)

BENZ (M271 / M272) 機油芯拆裝器 (Dr. 1/2", 14 角, 74 mm)

40 / 13 / 14 / 1.59'

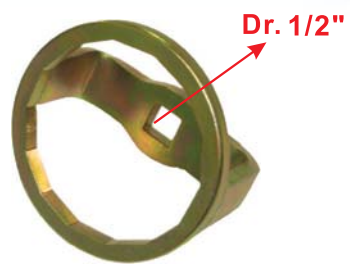
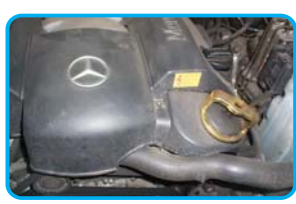

The tool is used for removing and installing the oil filter .



1993 BENZ S320 aluminum oil filter wrench.

H.C.B-A1131 BENZ OIL FILTER WRENCH (Dr. 1/2", 14 POINTS, 74 mm)

BENZ 機油芯扳手 (Dr. 1/2", 14 角 , 74 mm)

50 / 8.7 / 11 / 2.7'

- Dimensions : Dr. 1/2", 14 POINTS, 74 mm.
- Application : All Mercedes-Benz models (Especially M271/M272). Audi (A3), BMW (E36), Citroen, Fiat, Ford, Lancia, Mazda, Nissan, Opel, Peugeot, Porsche (Cayenne Diesel 3.0 L), Renault, Toyota, VW (Golf IV), Ford Metrostar....., etc.
- Caution : Please use 27 mm socket with a wrench to manipulate the tool when the torque is over 25 Nm, otherwise the tool will risk being broken. The torque value limit is 25 Nm if the tool is operated with a wrench.

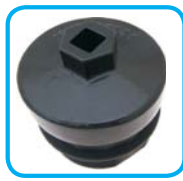
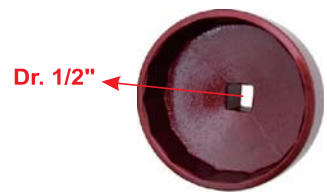

H.C.B-A1243 BENZ ML, BMW OIL FILTER WRENCH (Dr. 1/2", 14 POINTS, 84 mm)

BENZ ML, BMW 機油芯扳手 (Dr. 1/2", 14 角 , 84 mm)

- Dimensions: Dr. 1/2", 14 points, 84 mm.
- Application: 2007 Dodge Sprinter, Mercedes-Benz E320 (2007), C320, CLS320, E280, S320, ML280, ML320 and the 2007 Jeep Cherokee with the 3.0L V6 CRD (Common Rail Diesel) engines, BMW....., etc.

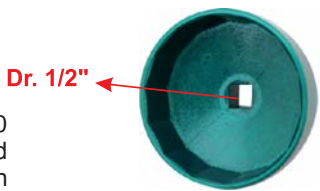

BENZ ML
67 402 17 429
MANN+HUMMEL 1
>PA 66-GF 35<

BMW 658 103 008
0 >PA66-GF35<
7 521 353

H.C.B-B1243 **BENZ ML, BMW OIL FILTER WRENCH (Dr. 1/2", 14 POINTS, 84 mm)**

BENZ ML, BMW 機油芯扳手 (Dr. 1/2", 14 角, 84 mm)

- Dimensions: Dr. 1/2", 14 points, 84 mm.
- Application: 2007 Dodge Sprinter, 2007 Mercedes-Benz E 320 and 2007 Jeep Cherokee with the 3.0L V6 CRD (Common Rail Diesel) engines, BMW, Benz OM 642 Engine CDI
- Engines: C320, CLS320, E280, S320, ML280, ML320, etc.



H.C.B-A1141 **4 PCS OIL DIPSTICK KIT FOR BENZ**

4 PCS BENZ 油尺組



A BENZ ENGINE OIL LEVEL GAUGE (VOLUTE)

- Material No. 120589072100
- Engine Type : 112.113.271.272. 273 647.648
- Remark: VOLUTE
- Measuring rod for measuring oil level and for checking length of oil pipe.
- Full length: 930mm
- Reference: H.C.B-A1110
- Blue Color

B BENZ ENGINE OIL LEVEL GAUGE (STRAIGHT)

- Material No. 120589062100
- Engine Type: 103.943.984/985.104. 111.119.120.137.603.913/963.97.604. 605.606.611.613.628.612.626.965
- Remark: Straight
- Dipstick for determining oil level and inspecting length of dipstick guide tube.
- Full length: 930mm
- Reference: H.C.B-A1109
- Yellow Color

C BENZ 722.7 TRANSMISSION OIL LEVEL GAUGE

- The tool is designed for measuring the oil level of transmission.
- Full length: 920 mm
- Application: Transmission type 722.7, 722.8, 716.5.
- Reference: H.C.B-A1146
- Green Color

D BENZ 722.6 TRANSMISSION OIL LEVEL GAUGE

- Genuine stock No.: 140 589 15 21 00
- The tool is designed for checking ATF level.
- Application: MERCEDES models 1997 and newer with 722.6 transmission.
- Full length: 1220mm
- Reference: H.C.B-A1094
- Red Color

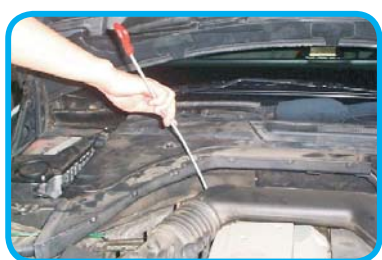



H.C.B-A1109 BENZ ENGINE OIL LEVEL GAUGE (STRAIGHT)

BENZ 機油尺 (直型)

100 / 4 / 5 / 0.77'

- Material No. 120589062100
Engine Type: 103.943/984/985,104,111,119,120,137,603.913/963/97,604,605,606,611,612,613,628,612.965,647,648,629
- Remark: Straight
- Dipstick for determining oil level and inspecting length of dipstick guide tube.
- Full length: 930 mm
- Reference: H.C.B-A1109
- Yellow Color

Specification of H.C.B.-A1109 ,H.C.B.-A1110 Engine Oil Level Gauge: for Car after September 2000

MODEL	CHASSIS NO.	ENGINE TYPE	HIGHEST LEVEL (cm)	LOWEST LEVEL (cm)
C240	203.061	112.912	16.8	14.8
C240	203.261			
CLK240	209.361			
CLK240 Cabriolet	209.461			
E240	211.061	112.913		
E240	211.261			
C320	203.064	112.946		
C320	203.264			
C320	203.274			
E320	211.065	112.949		
E320	211.265			
CLK320	209.365	112.955		
CLK320 Cabriolet	209.465			
C32 AMG K	203.065			
C32 AMG K	203.265			
SL350	230.467	112.973		
SL500	230.475	113.963	15.0	13.0
E500	211.070	113.967		
E500	211.270	113.968		
CLK500	209.375			
CLK500 Cabriolet	209.475			
E500 4 MATIC	211.083	113.969		
E500 4 MATIC	211.283			
S430	220.070	113.941	11.4	9.2
S430 L	220.170			
CL500	215.375			
S500	220.075	113.960		
S500 L	220.175			
S500 PULLMAN	220.875			
CL55 AMG	215.373	113.986		
S500	220.075			
S500 L	220.175			
S55 AMG	220.073			
S55 AMG L	220.173			



H.C.B-A1110 BENZ ENGINE OIL LEVEL GAUGE (VOLUTE)

BENZ 機油尺 (渦型)

100 / 4 / 5 / 0.77'

- Material No. 120589072100
- Engine Type: 112.113.271.272.273
- Remark: VOLUTE
- Measuring rod for measuring oil level and for checking length of oil pipe.
- Full length: 930 mm
- Reference: H.C.B-A1110
- Blue Color

MODEL	CHASSIS NO.	ENGINE TYPE	HIGHEST LEVEL (cm)	LOWEST LEVEL (cm)
CL500 AMG K	215.374	113.991	11.4	9.2
S55 AMG K	220.074			
S55 AMG K L	220.174			
S55 AMG PULLMAN	220.874			
MODEL	CHASSIS NO.	ENGINE TYPE	HIGHEST LEVEL (cm)	LOWEST LEVEL (cm)
E55 AMG K	211.076	113.990	17.2	15.6
E55 AMG K	211.270			
SL55 AMG K	230.474			
MODEL	CHASSIS NO.	ENGINE TYPE	HIGHEST LEVEL (cm)	LOWEST LEVEL (cm)
CL600	215.378	137.970	11.6	10.5
S600L	220.178			
S600 PULLMAN	220.878			
MODEL	CHASSIS NO.	ENGINE TYPE	HIGHEST LEVEL (cm)	LOWEST LEVEL (cm)
C200 K	203.042	271.940	12.7	10.4
C200 K	203.242			
C200 K	203.742			
CLK200 K	209.342			
CLK200 K Cabriolet	209.442			
E200 K	211.042	271.941		
E200 K	211.242			
C200 CGI K	203.043	271.942		
C200 CGI K	203.243			
C200 K	203.743			
CLK200 CGI K	209.443	271.943		
CLK200 K	209.343			
E200 K	211.043	271.943		
E200 K	211.343			
C180 K	203.046	271.946		
C180 K	203.246			
C180 K	203.746			
C230 K	203.040	271.948		
C230 K	203.740			

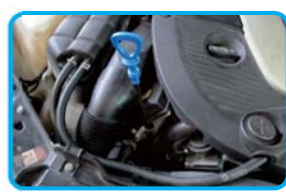

H.C.B-A1249 BENZ OIL PAN WRENCH (14 mm HEX x 13 mm BOX)

BENZ 油底殼扳手 (14 mm 六角凸 x 13 mm 六角孔)

- For oil filter plug on M8 gearbox
- Used for the R and R of the differential oil filler plug on many BMW and MERCEDES-BENZ.
- Application: Engine model M102.92/93/96/98/99, 103, 104, 110.92/98/99, 112, 113, 116, 117, 119, 120, 266, 275, 285, 601, 602.91/93/94/96, 603.91/93/96/97, 604, 605, 606, 615, 616, 617.91 /95
- Application: BENZ transmission model 716, 717, 722, 637

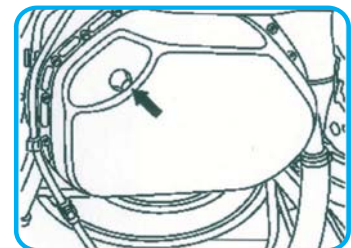
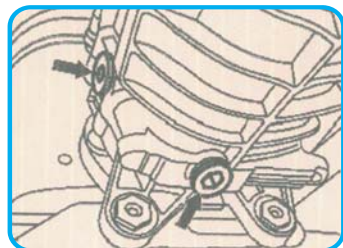

H.C.B-A1349 BENZ OIL PAN WRENCH (14 mm HEX x 17 mm BOX)

BENZ 油底殼扳手 (14 mm 六角凸 x 17 mm 六角孔)

- To service differential and transmission drain plugs.
- Application: M110.107.116.117.123.124.126.129.140.170.201. 202.208.210.220.615.616.617.716.717



H.C.B-A1145 HEATED OXYGEN SENSOR SOCKET (Dr. 1/2", 22 mm)

含氧感應器套筒 (歐規) (Dr. 1/2", 22 mm)



- Put a slot in the side of this wrench to accommodate connectors on heated oxygen sensors, which usually do not fit in the standard sensors wrenches. The extended and reinforced body removes the most stubborn sensors without rounding them off.
- Features : Dr. 1/2" of double square. SW 7/8" (22 mm) of hexagon.
- Flare nut for vacuum switch & oxygen sensor service on the computer-controlled engines.
- Application: FORD, TOYOTA, NISSAN, BENZ, BMW and most of the European Cars.



010
HWANG CHERNG BIN
 Specialty Tools Inc.

SINCE 1990

Benz Engine



H.C.B-B1145

HEATED OXYGEN SENSOR SOCKET (Dr. 3/8", 22 mm)

含氧感應器套筒 (歐規) (Dr. 3/8", 22 mm)

60 / 9 / 10.4 / 1'



- Put a slot in the side of this wrench to accommodate connectors on heated oxygen sensors, which usually do not fit in the standard sensors wrenches. The forged body, more reinforced to remove the most stubborn sensors without rounding them off.
- Features : Dr. 3/8" of double square. SW 7/8" (22 mm) of double hexagon.
- Flare nut for vacuum switch & oxygen sensor service on the computer-controlled engines.
- Application: FORD, TOYOTA, NISSAN, BENZ, BMW and most of European cars.

H.C.B-A1251

BENZ SPARK PLUG SOCKET (Dr. 3/8" x 5/8") (16 mm)

BENZ 火星塞套筒工具 (Dr. 3/8" x 5/8") (16 mm)

- Spark plug socket 5/8" (16 mm) with retaining spring and joint, Dr. 3/8" outer diameter 22 mm, length 93 mm.
- Application: M112, 113, 137, 155, 166, 271, 272, 273, 275, 902, 906 and X6



And motorcycles BMW C1, KAWASAKI, YAMAHA, HONDA, SUZUKI, DUCATI, as well as MERCEDES-BENZ passenger cars e.g. A-Class (type 168, 169), B-Class (type 245) With ball joint With fixing clamp for a firm hold of the spark plug short style inside square drive 10 = 3/8"

H.C.B-B1251

SPARK PLUG SOCKET (Dr. 3/8", 12 POINTS, 14 mm)

萬用高效能火星塞套筒 (Dr. 3/8", 12 角, 14 mm)

- Size: Dr. 3/8", 14 mm, 12 Points, 90 mm/L.
- With fixing clamp for a firm hold of the spark plug
- 12-Point profile enables application of 14 mm spark plugs with 6-Point and 12-Point
- Application on BMW E 90 N 54 engine, 335 limousine since 2006, RENAULT Modus, Twingo, Clio, Kangoo with 1.2 16 V engine, PEUGEOT 207, 307, CITROËN C4 with 1.4 and 1.6 l 16 V engine, C5 with 2.0 HPI engine as well as on MERCEDES-BENZ engine M 156, engine M 276, NISSAN Micra, Note, MINI 1.2 - 1.4 l 4-cyl. since 2007, INFINITY



H.C.B-A1128

MERCEDES-BENZ V6 ENGINE SPARK PLUG BOOT PULLER

BENZ V6 火星塞高壓線扳手

100 / 19.4 / 22.5 / 1.73'



- Special angle design with 17 mm wrench and a lever for removing and installing the wire easily.
- Application: BENZ V6 engine.

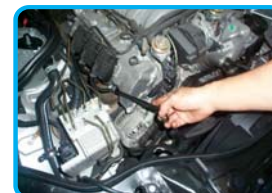



010
HWANG CHERNG BIN
 Specialty Tools Inc.

賓士引擎修護工具
 BENZ Engine Repair Tool

H.C.B-A1144 BENZ (M111) OIL SEALING INSTALLER

BENZ (M111) 油封安裝工具

20 / 19.2 / 21.6 / 1.94'

- 210 589 00 15 00 drift punch for BENZ (M111) engine.
- Genuine stock No.: A111 016 0721 sealing; No.: 210 5859 00 15 00 drift punch.
- The seals get crack because they expand when heat and contracts with cold.
- Easy and quick to install.



H.C.B-A1167 SCANIA, BENZ (W203 / W209) WRENCH SOCKET (FLUID RESERVOIR ON CONDENSER) (Dr. 1/2", 27 mm)

SCANIA, BENZ (W203 / W209) 冷凝器貯油槽套筒扳手 (Dr. 1/2", 27 mm)

- For screw plug removal and installation on fluid reservoir on condenser.
- Also used for SCANIA front wheel plastic cover.
- Application: BENZ (W203/W209) & SCANIA truck.
- Genuine Stock No.: 203 589 00 10 00.



SCANIA(P340)



BENZ(W203)

H.C.B-A1106 BENZ (M112 / M113) CAMSHAFT ALIGNMENT TOOL

BENZ (M112 / M113) 凸輪軸正時工具組

20 / 20 / 21.7 / 1.94'

- Holds camshaft in 40° TDC position (left / right side)
- Application: BENZ M112/M113
- **BENZ OEM no. ref.:** LH 112589013200
RH 112589003200

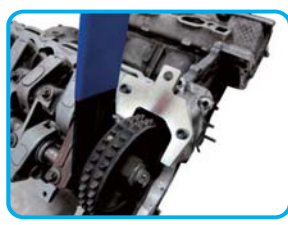

Benz Engine

H.C.B-C1327 BENZ AMG M156 TIMING TOOL KIT

BENZ AMG M156 正時工具組

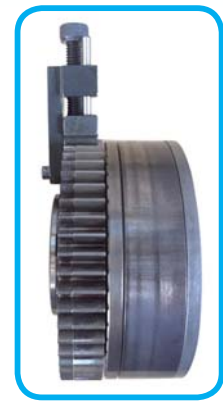

- Basic position of camshafts for a 40° crank angle after top dead center.
- Application: BENZ AMG 156.ML 63 AMG.S 63L AMG.S 63 AMG.
R 63 AMG L 4MATIC. R63 AMG 4MATIC
E 63 AMG. CLS 63 AMG. CLK 63 AMG.
CLK 63 AMG Black series.
CLK 63 AMG Cabrio.
CL 63 AMG

Parts No.	OEM No	Description
H.C.B-C1327-1	156 589 00 61 00	Camshaft fixing base
H.C.B-C1327-2	156 589 00 61 00	Camshaft alignment tool
H.C.B-C1327-3	156 589 00 32 00	Locating plate
H.C.B-C1327-4	156 589 01 63 00	Compressing tool

H.C.B-D1159 **NEW** BENZ (M271) ALIGNMENT TOOL KIT

BENZ (M271) 正時工具組



- Application:
Mercedes - BENZ: CLK 200K (W209), C180K, C200K, C230K (W203),
C-Coupe C160K, C180K, C200K, C230K, E200K (W211),
SLK 200K (R171), C180K (W204), CLC180K, CLC200K,
C180CGI, C200CGI, C250CGI (W204), E200CGI,
E250CGI (W212, C207)
Engine: 1.6/1.8
Engine code: All BENZ (M271)



Ref	Parts No.	OEM no.	Description
1	A1159-1	271 589 00 61 00	For drawing in the timing chain, and retaining timing chain with camshaft sprockets in proper timing position.
2	A1159-2	271 589 00 61 00	To position the camshafts in the installed position.
3	B1159-1	271 589 00 15 00	To install the plug into the timing case cover (Access to chain tensioner).
4	B1159-2	271 589 00 31 00	For unloading the timing chain tensioning device.
5	A1436	271 589 00 10 00	For removing crankshaft front gear wheel and releasing the timing chain
6	D1159-6		To position the camshafts in the installed position (FACELIFT)
7	A1022-A		To fix the camshaft
8			Blow Mould Case



010
HWANG CHERNG BIN
 Specialty Tools Inc.

賓士引擎修護工具
 BENZ Engine Repair Tool

H.C.B-C1159 **BENZ (M271) ALIGNMENT TOOL KIT**

BENZ (M271) 正時工具組

4 / 15.5 / 16.5 / 3.6'

- This kit includes H.C.B-A1159-1, H.C.B-A1159-2, H.C.B-B1159-1, H.C.B-B1159-2, H.C.B-A1436.
- Genuine Stock Numbers:
 H.C.B-A1159-1 Genuine stock No. 271 589 01 40 00
 H.C.B-A1159-2 Genuine stock No. 271 589 00 61 00
 H.C.B-B1159-1 Genuine stock No. 271 589 00 15 00
 H.C.B-B1159-2 Genuine stock No. 271 589 00 31 00
 H.C.B-A1436 Genuine stock No. 271 589 00 10 00 09
- Use to set up and cam timing during chain replacement.
- Application: BENZ (M271)
- **BENZ OEM no. ref.:** 271 589 01 40 00, 271 589 00 61 00



H.C.B-A1420 **BENZ (M137/M275/M285) TIMING TOOL KIT**

BENZ (M137/M275/M285) 正時工具組

- This master tool kit is designed for positioning the camshaft in 30 degree TDC position.
- Application:
 M275, M285: The set C only used for left bank of cylinder and A&B used for right bank.
 M137: Use the set A&B to loosen and tighten mounting screws for the camshaft sprocket and adjusting the timing.

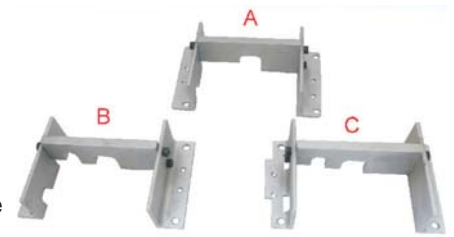

H.C.B-A1516 **BENZ (M157/M276/M278) TIMING TOOL KIT**

BENZ (M157/M276/M278) 正時工具組

- Special design to align the camshaft timing angle for correct position.
- Application: BENZ M157, M276, M278 engine
- **BENZ OEM no. ref.:** 276 589 01 40 00

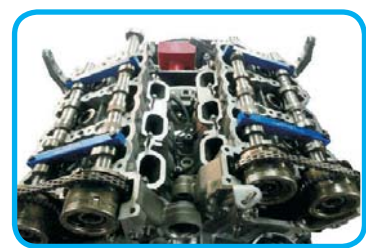

H.C.B-A1524 **BENZ (M133/M270/M274) ENGINE TIMING TOOL KIT**

BENZ (M133/M270/M274) 正時工具組

- This holding device can hold and fix the camshaft.
- This can slacken and tighten the bolts attaching to the camshaft gears.
- **BENZ OEM no. ref.:** 270 589 00 61 00

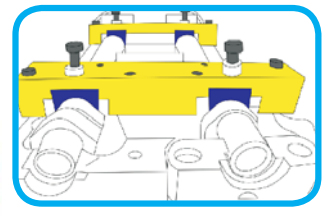
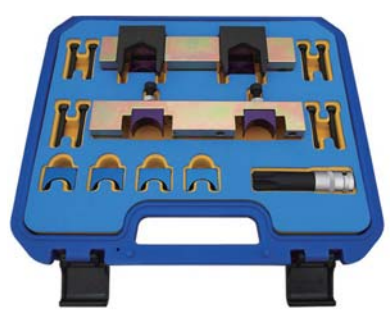

Benz Engine

H.C.B-A1546 BENZ DIESEL ENGINE TIMING TOOL KIT (M651)

BENZ 柴油引擎正時工具組 (M651)

- The retaining device can to position the camshafts in the installed position, also for turning, installing, and removing the crankshaft pulley.
- Application: BENZ M651 engine (after 2007)
- **BENZ OEM no. ref.:** 651589014000, 651589004000



H.C.B-B1546 BENZ ENGINE TIMING TOOL KIT (M651) (2.0D / 2.2D / 2.5D)

BENZ 柴油引擎正時工具組 (M651) (2.0D / 2.2D / 2.5D)

- Application: BENZ OM 651 VOLUME 2.0D/ 2.0D /2.2D /2.5D
Some models of cars: Mercedes Benz GLK (W204), Mercedes Benz CLA 200 CDI, Mercedes Benz CLA 220 CDI, Mercedes Benz A Class W176, Mercedes-Benz Sprinter 316CDI OM651 etc.
- **BENZ OEM no. ref.:** 651589014000,651589004000, 651589024000



H.C.B-C1546 **NEW** BENZ ENGINE TIMING TOOL KIT (M651) (1.8/2.0D / 2.2D / 2.5D)

BENZ引擎正時工具組 (M651) (1.8 /2.0D / 2.2D / 2.5D)

- The retaining device can position the camshafts in the installed position, also for turning, installing, and removing the crankshaft pulley.
- Application: BENZ OM 651 VOLUME 2.0D / 2.2D / 2.5D
- Some models of cars: Mercedes Benz GLK (W204), Mercedes Benz CLA 200 CDI, Mercedes Benz CLA 220 CDI, Mercedes Benz A Class W176, Mercedes-Benz Sprinter 316CDI OM651 etc.
- **BENZ OEM no. ref.:** 651589014000, 651589004000, 651589024000, 651589026300



H.C.B-A1640 **NEW** BENZ (OM651) SWITCHING VALVE SOCKET (Dr. 1/2", 43.5 mm, 6 POINTS)

BENZ(OM651) 機油洩壓閥套筒 (Dr. 1/2", 43.5 mm, 6 角)



SWITCHING VALVE
#MA651 180 01 15



- This tool is designed for the removal/installation of switching valve
- Switching valve's parts no. : 651 180 01 15



010
HWANG CHERNG BIN
 Specialty Tools Inc.

賓士引擎修護工具
 BENZ Engine Repair Tool

Benz Engine

H.C.B-A1436 **BENZ (M271) CAMSHAFT FRONT GEAR WHEEL SOCKET (T100)**

BENZ (M271) 凸輪軸前皮帶齒輪套筒 (T100)

- This socket is used for removing camshaft front gear wheel.
- Application: BENZ M271
- Genuine No.: 271 589 0010 0009/11CW



H.C.B-A1330 **BENZ TIMING LOCKING TOOL KIT**

BENZ 正時固定工具組 (固定飛輪用)

- Used to lock cams and flywheel on a range of Mercedes BENZ models.
- Suitable for a wide range of Benz, including both Petrol and Diesel engines.



H.C.B-A1291 **BENZ FLYWHEEL RETAINING LOCK TOOL**

BENZ 飛輪固定工具

- To lock crankshaft on starter ring gear (mount in starter hole) for vehicles with left and right-hand steering.
- Application: BENZ Engine M112, 113, 137, 155, 156, 272/979, 273, 629, 642/992
- N.W. :0.43 KG
- Genuine no.: 112 589 03 40 00



H.C.B-A1305 **BENZ (M102/M103/M104/M111/M601/M602/M603/M605/M606/M611/M612/M613) FLYWHEEL LOCKING TOOL**

BENZ (M102/M103/M104/M111/M601/M602/M603/M605/M606/M611/M612/M613) 飛輪支撐器

- Application: BENZ (M102/M103/M104/M111/M601/M602/M603/M605/M606/M611/M612/M613)
- Size of bolts: M6 x P1.0 x 90 mm
- Locks flywheel at starter ring gear under the transmission.
- N.W.: 0.2003 KG
- Genuine no.: 601589 02 40 00



H.C.B-A1334 **BENZ CAMSHAFT LOCKING PIN**

BENZ 凸輪軸固定銷

- Every pairs of pin connected with a chain. The main function is to fix the camshaft in the installed site.
- Application: BENZ engine model M111.119,604, 605, 606, 611/980, 612, 613, 628, 629, 640, 642/922, 612.965/966, 646, 647, 648 / B180
- Genuine no.: 111 589 03 15 00

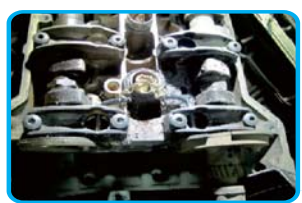



H.C.B-A2008

COOLING SYSTEM TESTER (14 PCS)

水箱壓力測漏組 (14 PCS)

5 / 19.2 / 20.5 / 3.83'



H.C.B-A2008-14

ACCESSORY FOR METROSTAR

福特天王星專用配件



H.C.B-A2008-15

ACCESSORY FOR MAZDA

MAZDA 專用配件



H.C.B-A2008-16

ACCESSORY FOR BENZ (A-CLASS)

BENZ (A-CLASS) 水箱蓋



H.C.B-A2008-16T

ACCESSORY FOR TOYOTA (DIESEL)

TOYOTA 專用配件 (柴油車)



H.C.B-A2008-17

ACCESSORY FOR BMW (E60/E63/E64/E65) (5 SERIES)

BMW 5 系列水箱蓋 (E60/E63/E64/E65)



H.C.B-A2008-18

ACCESSORY FOR VW (SHARAN 1.8T 2.8)

VW (SHARAN 1.8T 2.8) 水箱蓋



H.C.B-A2008-19

ADAPTOR FOR BENZ SPRINTER

BENZ SPRINTER 水箱蓋



- Application: NISSAN, MITSUBISHI, MAZDA, SUBARU, TOYOTA, HONDA, FORD, GM, CHRYSLER, VW, AUDI, VOLVO, SAAB, MERCEDES-BENZ, BMW, RENAULT, FIAT, ALFA ROMEO, INFINITI, GEO, SUZUKI, ISUZU, LEXUS, OPEL, PEUGEOT, JEEP, ROVER, CITROEN and trucks

Description / Specification

0: Thermometer

1: Pressure Testing Pump With Gauge NO.2~3 are Test Adapters

2: Large Truck, GM (CADILLAC)

3: BENZ, FORD, Large Truck, Vehicle 123 series, GM BUICK, JEEP

4: PEUGEOT · Vehicle 124 series (MITSUBISHI, NISSAN, MAZDA, TOYOTA, SUBARU, INFINITI, GEO, SUZUKI, ISUZU, MITSUBISHI)

5: Vehicle 125 series (HONDA, TOYOTA, SUZUKI, MITSUBISHI)

6: OPEL, VW, FORD, BMW245, SAAB, JAGUAR

7: VOLVO, SAAB, AUDI, CITROEN, RENAULT, FLAT, PEUGEOT, ALFA, JEEP

8: New VW

9: VW T4, new AUDI A4, A5, A6, BMW345

10: BMW

11: AUDI, VW

12: FORD, INTERNATIONAL, GM, ROVER

13: BENZ

14: METROSTAR (optional)

15: MAZDA (optional)

16T: TOYOTA (diesel)(optional)

16: BENZ (A-class) (optional)

17: BMW (E60/E63/E64/E65) (optional)

18: VW (SHARAN 1.8T 2.8T) (optional)

19: BENZ(Sprinter)(optional)

H.C.B-A1255 13 PCS Dr. 1/2" ALTERNATOR INSERT BIT SOCKET KIT

發電機皮帶盤拆裝套筒組 (13 PCS)

12 / 15.6 / 16.5 / 0.82'

Applications :

- M10 x 110 mm BMW, Ford, GM, Mercedes, Porsche, Renault, VAG.
- T50 x 110 mm Mercedes A Class, Renault DCi.
- M10 x 64 mm BMW, Ford, GM, Mercedes, Porsche, Renault, VAG Without the need to remove the radiator.
- T50 x 64 mm Mercedes A Class, Renault DCi Without the need to remove the radiator.
- M10 x 110 mm with 28 mm Hex Cap for Renault.
- M10 x 64 mm with 28 mm Hex Cap for Renault Without the need to remove the radiator.



Item no	Specifications
1	SPLINE BIT:M8X75MM(L)
2	SPLINE BIT:M10X75MM(L)
3	TX-STAR BIT:T40X75MM(L)
4	TX-STAR BIT:T50X75MM(L)
5	HEXAGON BIT:8MMX75MM(L)
6	HEXAGON BIT:10MMX75MM(L)
7	TX-STAR BIT SOCKET WITH 33T NUT:T50X110MM(L)
8	SPLINE BIT SOCKET WITH 33T NUT:M10X110MM(L)
9	33TEETHX17MM HEX.ALTERNAOR NUT
10	33TEETHX22MM HEX.ALTERNAOR NUT
11	22MM HEX.AITERNATOR NUT
12	4POINTS AITERNATOR NUTX17MM HEX
13	1/2" SPUARE DRIVEX10MM HEX. BIT HOLDER



M10 for VW T5



H.C.B-B1255 22 PCS Dr. 1/2" ALTERNATOR INSERT BIT SOCKET KIT

發電機皮帶盤拆裝套筒組 (22 PCS)

10 / 22 / 23 / 1.2'

- Easy removal of freewheel pulley from altemator either on or off the vehicle.
- Allows alternator shaft to be held whlie the pulley retainer is removed.



Item no	SPECIFICATIONS
1	1-M10 Spline Bit Socket with 33T Nut: 110 mm (L)
2	1-M10 Spline Bit Socket with 31T Nut: 98 mm (L)
3	1-M10 Spline Bit by 12mm Hex. Drive Tip: 57mm (L)
4	1-M10 Spline Bit socket: 110mm (L)
5	1-T50 Tx-Star Bit Socket WITH 33t Nut: 110mm (L)
6	1-75mm (L.) , Spline : M8
7	1-75mm (L.) , Spline : M10
8	1-75mm (L.) , Tx-Star : T40,
9	1-75mm (L.) , Tx-Star : T50
10	1-75mm (L.) , Hexagon : 8mm
11	1-75mm (L.) , Hexagon : 10mm
12	1-33 Teeth Alternator Nut with 15mm Hex. Tip
13	1-33 Teeth Alternator Nut with 17mm Hex. Tip
14	1-33 Teeth Alternator Nut with 22mm Hex. Tip
15	1-17mm Hexagon Alternator Nut
16	1-22mm Hexagon Alternator Nut
17	1-28mmx 22 mm Hexagon Alternator Nut
18	1-28mmx 21 mm Hexagon Alternator Nut
19	1-28mmx19 mm Hexagon Alternator Nut
20	1-4 Points Alternator Nut with 17mm Hex. Tip
21	1-3 Points Alternator Nut with 38mm Hex. Tip
22	1-1/2" Square Drive X 10mm Hex. Bit Adapter



H.C.B-D1255

30 PCS Dr. 1/2" ALTERNATOR INSERT BIT SOCKET KIT

發電機皮帶盤拆裝套筒組 (30 PCS)

8 / 21.7 / 22.7 / 1.5'

- Easy removal of freewheel pulley from alternator either on or off the vehicle.
- Allows alternator shaft to be held while the pulley retainer is removed.



Item no	SPECIFICATIONS
1	1-M10 Spline Bit Socket : 120mm(L.)
2	1-M10 Spline Bit Socket : 140mm(L.)
3	1-M10 Spline Bit, 14mm Hex. Drive : 57mm(L.)
4	1-3/8" Dr. M10 Spline Bit Socket with 31T Nut : 90mm(L.)
5	1-8mm Hexagon Bit Socket : 120mm(L.)
6	1-T50 TX-Star Bit Socket : 120mm(L.)
7	1-75mm(L.) Spline Bit : M8
8	1-75mm(L.) Spline Bit : M10
9	1-75mm(L.) TX-Star Bit : T40
10	1-75mm(L.) TX-Star Bit : T50
11	1-75mm(L.) Hexagon Bit : 8mm
12	1-75mm(L.) Hexagon Bit : 10mm
13	1-10mm Hex. Drive x H10 Bit : 50mm(L.)
14	1-10mm Hex. Drive x H10 Bit : 70mm(L.)
15	1-33Teeth Alternator Nut - 15mm Hex. Tip (L.)
16	1-33Teeth Alternator Nut - 15mm Hex. Tip (S.)
17	1-33Teeth Alternator Nut - 17mm Hex. Tip
18	1-33Teeth Alternator Nut - 22mm Hex. Tip
19	1-17mm Hexagon Alternator Nut - inner size : 14mm
20	1-1/4" Dr. 10mm Hex. Socket
21	1-17mm Hexagon Alternator Nut
22	1-22mm Hexagon Alternator Nut
23	1-28mm x 22mm Hexagon Alternator Nut
24	1-28mm x 21mm Hexagon Alternator Nut
25	1-28mm x 19mm Hexagon Alternator Nut
26	1-17mm x 19mm Hexagon Alternator Nut
27	1-17mm x 21mm Hexagon Alternator Nut
28	1-4 Poins Alternator Nut with 17mm Hex. Tip
29	1-3 Poins Alternator Nut with 38mm Hex. Tip
30	1-1/2" Dr. x 10mm Hex. Bit Holder

H.C.B-A2251

40 PCS Dr. 1/2",SPECIAL INSERT BIT SOCKET KIT

發電機皮帶盤拆裝套筒組 (40 PCS)

4 / 24 / 25 / 1.25'

- 1-M10 Spline Alternator Combination Bit Socket
- ★ 1-T50 Tx-Star Alternator Combination Bit Socket
- ★ 4-Ribe : 100 mm(L)-M9 140 mm(L)-M10 240 mm(L)-M7,M8
- 7-Tamper Spline : 55 mm(L)-M16
78 mm(L)-M18 Impact Socket
100 mm(L)-M9,M16
140 mm(L)-M10,M12,M14
- ★ 8-Tx-Star : 100 mm(L)-Tamper.T80 ★
140 mm(L)-T40,T45,T50,T55,T60,T70
300 mm(L)-T30
- 9-Hexagon : 55 mm(L)-14,17,19 mm
65 mm(L)-22,24 mm
140 mm(L)-10,11,13 mm
240 mm(L)-7 mm,
1-240 mm(L),Ballpoint-5 mm
- ★ 9-1/4"Drive Tx-Plus Bit Socket :
T10,T15,T20,T25,T27,T30,T40,T45,T50





010
HWANG CHERNG BIN
Specialty Tools Inc.

賓士引擎修護工具
BENZ Engine Repair Tool

Benz Engine

H.C.B-A2186 BENZ ENGINE MOUNT WRENCH (16 mm) PAT.M365815

BENZ 引擎腳扳手 (16 mm)

- Special angle designed for removing the nuts from BENZ engine mount.
- Easy to use with multiple angles.
- Operators can use it in many angles instead of four directions.
- Size: 16mm/12 PT
- Application: BENZ W220, 210, 203, 221, 211, 204 (New Car)



H.C.B-A2187 BENZ ENGINE MOUNT WRENCH (17 mm) PAT.M365815

BENZ 引擎腳扳手 (17 mm)

- Special angel designed to remove the nuts from BENZ engine mount
- Operators can use them in many angles instead of four directions
- Size: 17mm /12PT
- Application: BENZ W124,140, 170,126,201,202,210



H.C.B-A2161 Dr. 1/2" x T50 STAR ALTERNATOR PULLEY REMOVER

發電機皮帶盤拆裝器

- Ideal tool for assembling and dismantling the freewheel pulley whilst changing the alternator or pulley on bosch alternators.
- Application: AUDI, BMW FORD, MERCEDES-BENZ, SKODA, VW
- N.W. : 0.18KG



H.C.B-A1289 BENZ C32 (M111) W203 PULLEY RIVET INSTALLER

BENZ C32 (M111) W203 機械增壓皮帶盤鉚釘座

- The main body of pulley and rivets would have clearances because rotational speeds after a period of time. It causes the pulley noisy. If changing rivets, they will have clearances with pulley no more.
- Application: BENZ W203
- N.W.: 1.81 KGS





H.C.B-C1293

BENZ TIMING CHAINS RIVETING TOOL KIT-SINGLE ROW AND DOUBLE ROW

BENZ 鉚釘鏈條正時工具組 - 單排及雙排

- For timing chains on Mercedes petrol and diesel engines.
- The separating tool and the riveting tool allow quick, easy and safe splitting and re-connection of the timing-chains - Simplex and Duplex - as well as the double-roller to be found on new Mercedes diesels from 9/95 onwards. On such chains, the timing chain pin is peened.
- Advantages:
Clean splitting of the old timing chain.
Correct and safe assembly of the replacement timing-chain.
Exact riveting of the new timing chain.
- Application: BENZ Model OM 601, 602, 603, 615, 616, 617, M102, 103, 116, 272 and SAAB, BMW

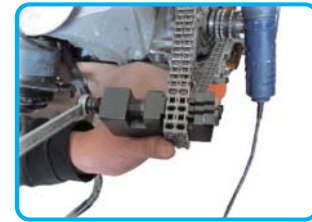

H.C.B-B1299

BENZ CDI-ENGINES COMMON RAIL INJECTOR PULLER KIT (SLIDE HAMMER STYLE)

BENZ 柴油引擎噴油嘴拉拔器 (滑鎚式)

- For removing stubborn injectors on Mercedes BENZ CDI engines and adapted tight common rail injectors without having to disassemble cylinder head.
The puller is additionally supported by the steel ball on the valve cover, which prevents the puller from tipping during the removal process.
- Application: Mercedes CDI engines 611,612,613,646,647,648 etc diesel engines
- Specification :

ITEM NO.	DESCRIPTION	Specification
1	Puller	M16 x P1.5
2	Hammer	φ 79 x 50L
3	Slide hammer bolt	M16 x P1.5 x 198L
4	Nut	M16 x P1.5 x 12.5L
5	Extraction nut	M27 x P1.0(BOSCH)
6	Blow mold case	
7	Connector	M16 x P1.5, M14 XP1.5
8	Extraction adaptor	H19 M12 x P1.75
9	Extraction adaptor	H19 M17 x P1.0
10	Extraction adaptor	M22 x P1.5, M22 x P1.0
11	Universal adaptor	M14 x P1.5, M10 x P1.5

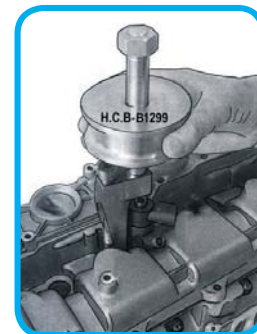

H.C.B-A1299

BENZ INJECTOR NOZZLE PULLER (SLIDE HAMMER STYLE)

BENZ 噴油嘴拔取器 (滑鎚式)

10 / 26.7 / 28 / 1.67'

- For removing stubborn injectors on Mercedes BENZ CDI engines and adapted tight common rail injectors without the necessity of disassembling cylinder head.
- The puller is additionally supported by the steel ball on the valve cover, which prevents the puller from tipping during the removal process.
- Application: Mercedes CDI engines OM 611.612.613





010
HWANG CHERNG BIN
 Specialty Tools Inc.

賓士引擎修護工具
 BENZ Engine Repair Tool



H.C.B-A1589 **BENZ (M271) INJECTOR NOZZLE REMOVER**

BENZ(M271) 噴油嘴拆卸器

- This tool is designed for removing the injector by slide hammer or the T bar.
- Application: BENZ M271 engine after 2007
- **BENZ OEM no. ref.:** 271 589 00 33 00



H.C.B-B1589 **BENZ (M271) INJECTOR NOZZLE REMOVER (W/SLIDE HAMMER)**

BENZ(M271) 噴油嘴拆卸器 (滑鎚式)

- This tool is designed for removing the injector.
- Application: BENZ M271 engine after 2007
- **BENZ OEM no. ref.:** 271 589 02 33 00



H.C.B-A1598 **BENZ (M278) INJECTOR NOZZLE REMOVER**

BENZ (M278) 噴油嘴拔卸器

- This tool is designed for removing the injector by slide hammer or the T bar.
- Application: BENZ M278 engine.
- Engines: 133,152,157,270,274,276,278
- **BENZ OEM no. ref.:** 278 589 00 33 00



H.C.B-B1598 **BENZ (M278) INJECTOR NOZZLE INSTALLER**

BENZ (M278) 噴油嘴安裝器

- Fuel injectors must be installed immediately after calibration of the sealing rings.
- Clean base surface for sealing ring on fuel injector
- Application: BENZ M278 engine.
- Engines: 133,152,157,270,274,276,278
- **BENZ OEM no. ref.:** 272 589 00 43 00
- Material: Stainless-steel



H.C.B-A2275 **4 PCS INJECTOR NOZZLE PULLER KIT**

4 PCS 噴油嘴拉拔器

- Injection nozzle puller tool for removing damaged Diesel injector
Screw off the nozzle head, Screw in the puller spindle, Insert the support ring, Push the support sleeve over the spindle and screw on the collar nut then pull out the nozzle by turning the collar nut.
- Support sleeve, Pull spindle, Shoulder nut M16×1.5, Support ring, Special bit insert 10 mm hex, Axial bearing, Circlip, Special socket insert 29mm hex
- With 29 mm diesel injector window socket screw off the nozzle head of the injector
- Using special 10mm Hex extractor key remove the insert from the injector.
- Place the support shaft bearing assembly over the injector ensuring the wide shoulders of the shaft support the tool.
- With a 10mm spanner or socket screw the shaft down into the injector.
- With a 24mm spanner or socket and an anti-clockwise motion draw the injector out of the cylinder head.
- Application:
Mercedes Benz sprinter 2.7 / ML270/ E-CLASS/108 CDi/Vito 110 CDi 16v Vito 112 16Vvc200 CDi 16v/ C220 CDi 16v/ E200 CDi 16v





H.C.B-A1303 BENZ A/C LOW SIDE COUPLER REMOVER

BENZ 冷氣低壓接頭拆卸器

- Application: BENZ W221 / W211 / W204 / W219
- Special designed for removing the A/C low side coupler.
- BENZ OEM no. ref.: 211 589 00 63 00



H.C.B-A1613 BENZ (M642) TIMING TOOL KIT

BENZ (M642) 正時工具組

- Special designed to align the camshaft timing angle for correct position.
- Application : BENZ M642 engine.
- BENZ OEM no. ref.: 642 589 00 31 00



H.C.B-A1313 BENZ (W124) STEERING OIL SEAL EXTRACTION / INSTALLATION TOOL KIT

BENZ (W124) 方向機油封拆裝工具組



Genuine Stock No.: 124 461 04 05 Fig. A



Fig. B

- Put A1313-2 into central nut (M 48 x P 1.5). (Fig. A)
- Installed A1313-1 outside of A1313-2, put ratchet wrench to A1313-2 and fixed central nut. Turning A1313-1 and loosen outer bolt nut (M 48 x P 1.5). (Fig. B)
- Take A1313-1 and A1313-2 off, removes outer and central nut. Then replace oil seal.

H.C.B-A1347 BENZ (M271/M272) CRANKSHAFT REAR SEALING RING INSTALLER

BENZ (M271 / M272) 曲軸後油封安裝器

- The crankshaft radial sealing ring has both a lip and a protective lip.
- This tool is design to prevent damage when assembling the cover to the crankshaft flange.
- Application: BENZ M271, M272
- Oil seal genuine stock : 271 011 05 32
272 010 06 14



H.C.B-A1504 BENZ POWER STEERING PUMP PULLEY

BENZ 動力方向盤拆裝工具組

- A disconnect tool to release the power steering line from pump.
- Application: BENZ (M271/M272)



H.C.B-A1558

BENZ CRANKSHAFT RADIAL SEAL INSTALLER

BENZ 曲軸徑向密封環安裝工具

- For replacing front and rear crankshaft radial sealing ring.
- Application: BENZ M102 /111/ 112/ 113/ 137/ 156/ 159/ 272/ 275/ 285/ 601/ 602/ 603/ 604/ 605/ 606/ 628/ 629
- **BENZ OEM no. ref.:** (Front) 119589011400 / (Rear) 651589016100



H.C.B-A1559

BENZ (M651) CRANKSHAFT RADIAL SEAL INSTALLER

BENZ (M651) 曲軸徑向密封環安裝工具

- For inserting front and rear radial shaft sealing ring of crankshaft.
- Application: BENZ M651 engine
- **BENZ OEM no. ref.:** (Front) 651589006100/ (Rear) 651589016100



H.C.B-A1577

BENZ VALVE ADJUST WRENCH (17 mm)

BENZ 汽門調整扳手 (17 mm)

- Offset Wrench.
- Double open end wrench, offset 17mm.
- Used for adjusting valves without the necessity of remove the spring clips.
- Can also be used to pry off spark plug connectors on 112 and 113 engines.
- Applicable engines: 110.92/98/99, 112, 113
- **BENZ OEM no. ref.:** 110 589 01 01 00

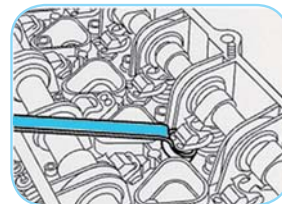

H.C.B-A1599

BENZ REAR BUMPER SOCKET (10 mm, 120 mm LONG SOCKET)

BENZ 後保險桿套筒 (10 mm, 120 mm, 長套筒)

- Special tool for the operation of the rear bumper screws, MERCEDES-BENZ type 204 (C-Class) station wagon and limousine, AUDI A3 since 2004, A4 since 2001, A6 since 2005, TT since 2007, BMW N55 cylinder head bolt.
- Note: Screw operation with threaded rod
- Tighten the screw with the torque value provided by the manufacturer
- Length: 120 mm



H.C.B-A1644

NEW

FUEL LINE CONNECTOR PLIERS

汽油管接頭拆卸鉗

- For removal and replacement of the connections on the in-line fuel filter.
- For the removal and replacement of connections when replacing the fuel filter on a wide variety of engines.
- Application: Mercedes Benz/ BMW/ Vauxhall/ Opel/ Volkswagen/ Audi/ Fiat
- **BENZ OEM no. ref.:** 163 589 00 37 00



H.C.B-A2314

NEW

CDI ENGINE GLOW PLUG TOOL

CDI 引擎預熱塞工具

- For unscrewing and disassembly of glow plugs in the cylinder head, especially for glow plugs that are stuck because of carbonization remains.
- Cylinder does not need to be removed any more.
- Fits all Mercedes Benz 10 mm glow plugs, engine codes 611-612-613... etc.





010

HWANG CHERNG BIN
Specialty Tools Inc.

賓士變速箱修護工具

BENZ TRANSMISSION REPAIR TOOL





010
HWANG CHERNG BIN
 Specialty Tools Inc.

賓士變速箱修護工具
BENZ Transmission Repair Tool

H.C.B-A1027-01-02-03-04-05

BENZ SLEEVE, ASSEMBLY DEVICE & ASSEMBLY FIXTURE

BENZ 變速箱拆裝工具組

- Sleeve for installing reverse gear piston in front cover. Assembly device for brake band piston B1.
- Assembly fixture for circlip on spring retainer of clutch K1 and K2. For installing reverse gear piston
- Application: Transmission 722.3, 722.4 & 722.5



H.C.B-A1027-01

BENZ ASSEMBLY FIXTURE

BENZ 變速箱離合器鼓活塞彈簧拆裝工具組

- For circlip on spring retainer of clutch K1 and K2, B3.
- Application: Transmission 722.3, 722.4 & 722.5.
- N.W.: 1.35KGS.
- Genuine stock NO. 201-1243

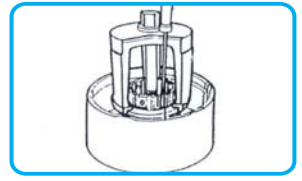
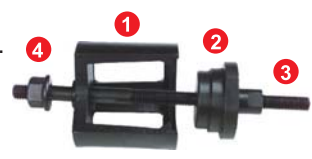

H.C.B-A1027-02

BENZ ASSEMBLY DEVICE

BENZ 變速箱制動帶活塞彈簧工具

- For brake band piston B1.
- Application: MERCEDES models 720.1, 722.0, 722.1, 722.3, 722.4 & 722.5.
- H.C.B-A1027-02-2 is used for Benz 722.4, H.C.B-A1027-02-1 is used for Benz 722.3.
- N.W.: 1.3 KGS.

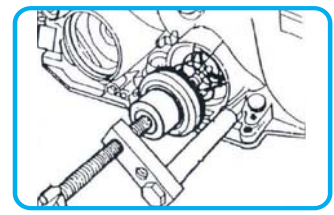

H.C.B-A1027-03

SLEEVE

變速箱橡膠圈拆卸工具組

- For installing reverse gear piston K1 and K2 into external disc carrier.
- Application: Transmission 722.3 & 722.5.
- N.W.: 0.5 KGS.
- Genuine stock No. 201-2014.

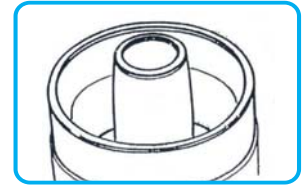

H.C.B-A1027-04

SLEEVE

油封導管

- For installing reverse gear piston.
- Application: Transmission 722.3 & 722.5.
- N.W.: 0.52KGS.
- Genuine stock NO. 126-0414



H.C.B-A1027-05

SLEEVE

油封導管

- Installing reverse gear piston in front cover.
- Application: Transmission 722.4.
- N.W.: 0.57KGS.
- Genuine stock No. 126-0414.



Benz Transmission





010
HWANG CHERNG BIN
Specialty Tools Inc.

SINCE 1990

Benz Transmission



H.C.B-A1029

BENZ 722.6 & 722.9 SLEEVE, ASSEMBLY DEVICE & ASSEMBLY FIXTURE

BENZ 722.6 & 722.9 變速箱拆裝工具組

5 / 20.6 / 21.5 / 1.59'

- Genuine stock No.: 140 589 13 43 00.
- Sleeve for installing reverse gear piston in front cover.
- Assembly fixture for circlip on spring retainer of clutch K1 and K2.
- Application: transmission 722.6, 722.9
- Assembly tool: B1/2, K1/2 to compress clutch packs and allow installation of retaining ring (722.6).

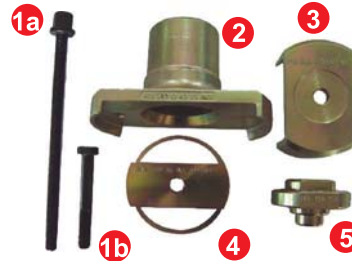

H.C.B-A1035

GEARBOX K/D RACK (REAR)

多功能變速箱拆裝架

H.C.B-A1035-1

ENGINE SUPPORTER

引擎支架

- For hanging up engine and making it steady.

H.C.B-A1035-2

SLOP OIL PAN

廢油盤

- For collecting the slop engine oil.

H.C.B-A1035-3

REAR-WHEEL DRIVE TRANSMISSION HOLDER KIT TW PAT. USA PAT. 7093809

後送變速箱拆裝架

- Rotating head enables engine to be placed in desired working positions.

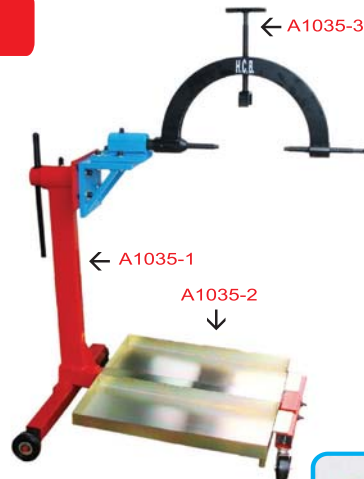

H.C.B-A1037

BENZ ASSEMBLY SLEEVE

BENZ 自動變速箱內部導向套管特殊工具組

NO.	MATERIAL NUMBER	SPECIFICATION
①	126 589 043100	TRANSMISSION MEASURE TOOL (RULER TYPE)
②	129 589 062300	TRANSMISSION MEASURE TOOL (PLATE)
③	126 589 101400	PISTON OIL SEAL INSTALLER
④	201 589 011400	K1 CLUTCH
⑤	126 589 031400	TRANSMISSION O RING SLEEVE

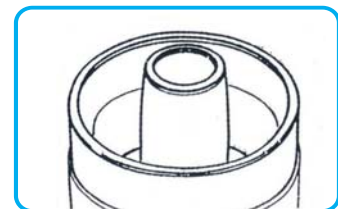

- Transmission seal assembly sleeve.
- N.W.: 5.5 KGS G.W.: 5.8 KGS



010
HWANG CHERNG BIN
Specialty Tools Inc.

賓士變速箱修護工具
BENZ Transmission Repair Tool

Benz Transmission



H.C.B-A1064 BENZ 722.3 & 722.5 SOCKET TOOL FOR PLUNGER

BENZ 722.3 & 722.5 活塞外導向套筒

- For extracting the plungers.
- N.W.: 1.03 KGS

No.	Material Number
①	129589011400
②	129589011401
③	129589011402



H.C.B-A1042 BENZ (W124) RIVET INSTALLER K1, K2

BENZ (W124) 鐵圈內油封鉚釘安裝器

- Iron ring inner oil seal rivet K/D tool
- N.W.: 15.5 KGS G.W.: 15.7 KGS



H.C.B-A1042-1 BENZ (W126/W140) RIVET INSTALLER

BENZ (W126/W140) 鉚釘安裝器

- The tool is used for installing the rivet.
- N.W.: 10.8 KGS G.W.: 11 KGS



H.C.B-A1042-3 RIVET

鉚釘



H.C.B-A1094 BENZ 722.6 TRANSMISSION OIL LEVEL GAUGE

BENZ 722.6 變速箱油尺

100 / 14 / 15 / 1.2'

- Genuine stock No.:140 589 15 21 00
- The tool is designed for checking ATF level.
- Application: MERCEDES models 1997 and newer with 722.6 transmission.
- Full length: 1220 mm





H.C.B-A1146

BENZ 722.7 TRANSMISSION OIL LEVEL GAUGE

BENZ 722.7 變速箱油尺

100 / 11 / 12 / 0.77'

- The tool is designed for measuring the oil level of transmission.
- Full length: 920 mm
- Application: Transmission type 722.7, 716.5.



H.C.B-A1208

UNIVERSAL TRANSMISSION CLUTCH SPRING COMPRESSOR PAT. M317319

萬用變速箱離合器壓板拆裝器

1 / 15.5 / 16.5 / 0.17'

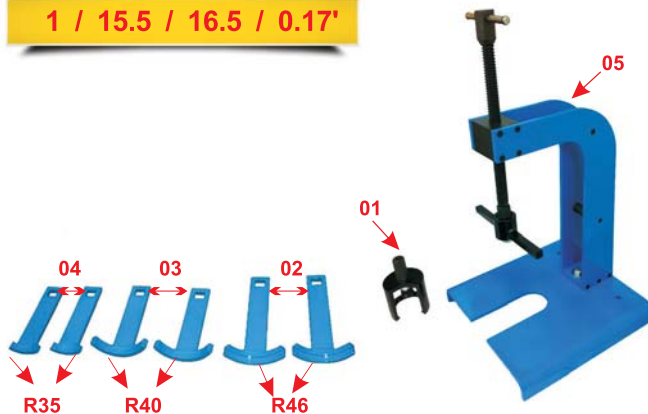

On BMW



On BENZ



On FORD



On VW

- To remove and install the transmission clutch piston snap ring.
- Adjustable for most models of European, Japanese and American cars and light trucks.
- Accessory 01, can be used on BENZ transmission rear clutch piston snap ring.
- Accessory 02, the wide arc plate, for using on all types and most of American and Japanese car automatic transmission clutch drums. For example: FORD, TOYOTA, MITSUBISHI... etc.
- Accessory 03, the middle arc plate, for using on most models of American cars and light trucks.
- Accessory 04, small arc plate, for using on BMW (4HP22, 5HP18...), VW, FORD Mondeo (CD4E)...etc.
- Accessory 05, main body of this tool: L300 mm x W300 mm x H330 mm.
- N.W: 15.5 KG G.W : 16.5 KG

H.C.B-A2036

TRANSMISSION DEPTH GAUGE

變速箱深度量尺

40 / 17.6 / 21 / 2.26'

- Place the parallel rest on transmission housing.
- Use the depth gauge and measure from the parallel rest to the parking gear and the contact surface of the deep-groove ball bearing in the transmission housing.

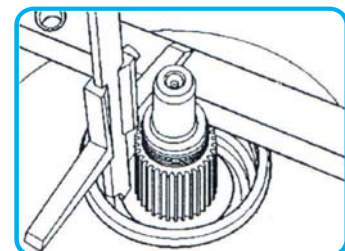



010
HWANG CHERNG BIN
 Specialty Tools Inc.

賓士變速箱修護工具
 BENZ Transmission Repair Tool

H.C.B-B2054 BENZ GEAR OIL PRESSURE GAUGE

BENZ 變速箱壓力錶

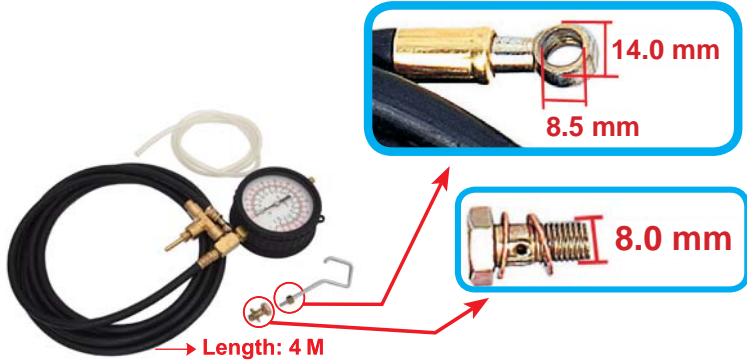

Benz Transmission



H.C.B-A1290 UNIVERSAL TRANSMISSION & ENGINE PRESSURE TESTER

萬用型變速箱 & 引擎壓力錶

- Dual gauges allow testing of automatic transmission shift and engine pressures.
- Kit includes: Two gauges 100 psi and 400 psi, hook and sufficient hose to bring gauges into car for road tests. For Benz 720.1, 722.0,722.1, 722.2,722.3, 722.4,722.5, 722.6
- Dial diameter: 2-1/2"
 Pressure range: A: 0~100 psi / 0~7 bar
 B: 0~400 psi / 0~28 bar
- Hosing length : 4 Meter
- Rubber protector 4 Meter of oil proof hose with super speed adaptor
- Application: All vehicles with ZF or GM automatic transmissions.
- N.W.: 3.6 KG



■ Specification:

No.	Size	Q'ty	No.	Size	Q'ty
1.	1/8" NPT to 1/8" NPT f/m elbow	1	9.	1/8" NPT to 1/8" NPT m/m extension	1
2.	1/8" PT to 1/8" NPT f/m adaptor	1	10.	M8xP1.0 to M8xP1.0 adaptor	1
3.	1/8" PT to M10x1.0 adaptor	1	11.	M6xP1.0 to M6xP1.0 adaptor	1
4.	1/8" PT to M8x1.0 adaptor	1	12.	M8xP1.0 screw	1
5.	1/8" PT to 1/4" PT f/m reducer	1	13.	M6xP1.0 screw	1
6.	1/8" PT to 3/8" PT f/m reducer	1	14.	M8 washer	4
7.	1/4" PT to 1/8" PT m/m reducer	1	15.	1/8" PT(m) to $\Phi 8$ adapted tube	2
8.	1/8" PT to 1/8" PT f/f coupler	1	16.	1/4" PT(m) to US standard quick disconnects	2

H.C.B-A1209 BENZ 722.9 TRANSMISSION OVERFLOW PIPE REMOVER

BENZ 722.9 變速箱油標拆卸器

- Drift for unclipping the overflow pipe in the oil pan when draining the oil.
- Application: BENZ 722.9 model transmission.
- N.W.: 0.134 KG

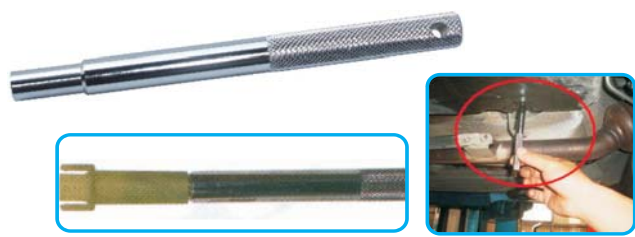



H.C.B-B1209

BENZ 722.9 TRANSMISSION OIL TOOL

BENZ 722.9 變速箱油工具

- This tool is designed for filling oil in the transmission.
- Application: BENZ 722.9



H.C.B-A1333

BENZ TRANSMISSION GEAR LEVER RUBBER INSTALLER

BENZ 變速箱排檔桿橡膠安裝器

- This pliers can install the nylon bushing used on all models of Mercedes Benz automatic transmissions, and some Ford's, BMW's ,VW,AUDI and many other manufacturers using ZF transmissions.
- This tool easily and safely pushes tough nylon bushings into place on the shift shaft. Works on several different bushing sizes.
- Application: BENZ W124/ W126/ W140/ W201/ W202/ W210...etc.



H.C.B-A2230-T100

BENZ 722.9 TRANSMISSION SOCKET (Dr. 3/4", T 100)

BENZ 722.9 變速箱套筒 (Dr. 3/4", T 100)

- Size: T-100 Socket, Dr. 3/4"
- Used to remove the plug, for accessing the parking pawl detent on the 722.9 Mercedes transmissions.



H.C.B-A2204

PNEUMATIC OIL & LIQUID DISPENSER (6000 c.c.)

吸排兩用液體分裝機 (6000 c.c.)

6 / 16 / 17 / 4.7'

- Provide with the safety valve helps release pressure automatically when it reaches the pre-setting pressure (43 psi (3 kg/cm²)).
- Provide with pressure gauge makes read and control the air pressure in the tank easier.
- Application: BENZ 722.9

■ SPECIFICATIONS:

Air inlet	1/4"
Avg. Air cons	2 CFM
Temperature range	-19.4°C ~ 60°C
Max. Capacity	6000 c.c.





SINCE 1990

010

HWANG CHERNG BIN

Specialty Tools Inc.

BMW 底盤修護工具

BMW CHASSIS REPAIR TOOL



H.C.B-A1588



H.C.B-B1568

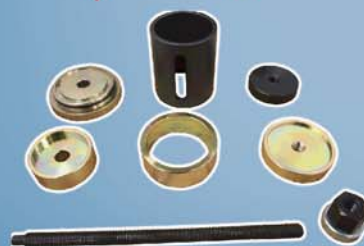
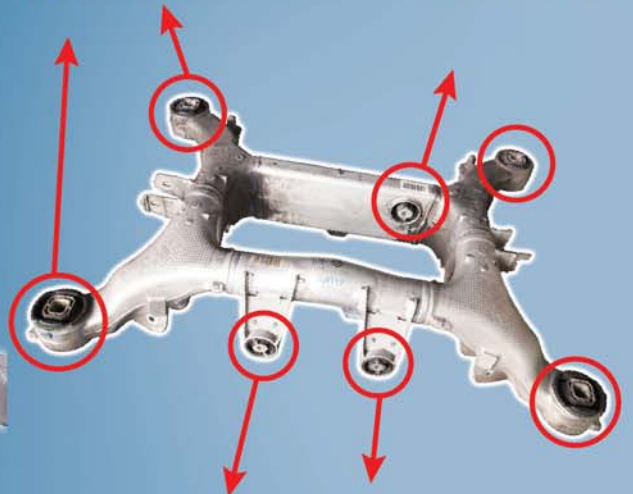

H.C.B-A1568





010
HWANG CHERNG BIN
Specialty Tools Inc.

BMW Chassis



H.C.B-A1004

ON CAR

BMW (E32/E34) UPPER SUB-FRAME BUSH EXTRACTOR/INSTALLER PAT.165163. USA PAT.6389668

BMW (E32/E34) 上三角台鐵套拆裝工具組

5 / 17.3 / 18.5 / 1.59'

- For removing and installing metallic bushes on upper sub-frame.
- Application: BMW E32/E34.



H.C.B-A1034

ON CAR

BMW (E34) HUB REMOVER/INSTALLER PAT. 172921

BMW (E34) 輪軸拆裝工具組

5 / 22 / 23.4 / 1.59'

- The tool is designed for professional removal and installation of rear wheel hub.
- Application: BMW E34.



H.C.B-A1038

ON CAR

BMW (E30/E36/E46) BUSH EXTRACTION / INSTALLATION TOOL KIT

BMW (E30/E36/E46) 三角架鐵套拆裝工具組

4 / 23.7 / 25.4 / 1.7'

- Used for R&R of rear wheel bearing located in wheel carrier.
- Application: BMW E30, E36, E46.



MODEL: BMW (E46)

H.C.B-C1168

ON CAR

BMW (E30/E36) LOWER CONTROL ARM BALL JOINT REMOVER/INSTALLER PAT. M333280

BMW (E30/E36) 三角架球接頭拆裝工具組

4 / 27.4 / 28.2 / 1.28'

- The C-clamp was forged, its material is SCM440 and hardness is HRC38°~42°
- Removing and installing the ball joint.
- Application: BMW E30, E36



Extraction



Installation





010
HWANG CHERNG BIN
 Specialty Tools Inc.

BMW底盤修護工具
BMW Chassis Repair Tool

H.C.B-A1460 BMW (E70) INSIDE SPRING VISE

BMW (E70) 彈簧避震器拆裝工具組

- Used to R&R the rear springs on vehicles without automatic ride height option.
- Application note: Never use an air impact driver on spring tensioner as damage can result. Instead, use the supplied special tool. Always use on BMW spring.
- **BMW OEM no. ref.:** 335 100

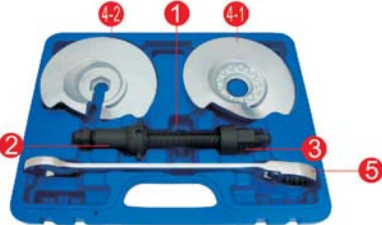

H.C.B-A1047 MACPHERSON SPRING DAMPER EXTRACTION / INSTALLATION TOOL KIT (CHANGEABLE)

麥花臣式彈簧避震器拆裝工具組 (可換式)

1 / 13.8 / 14.9 / 1.18'

- Spring compressors are multi-applicable tools specifically developed for modern Macpherson suspensions, using ranges of 3 sets of interchangeable mono block forks.
- Designed for used with air impact.
- Application: BMW, TOYOTA, FORD, MITSUBISHI, VW, AUDI, SAAB, NISSON, HONDA, ACCORD, SUBARU, VOLVO, OPEL and PORSCHE.
- N.W.: 14 KGS G.W.:15KGS
- Spring specification:
 A: \varnothing 75 ~ \varnothing 110
 B: \varnothing 110 ~ \varnothing 140
 C: \varnothing 140 ~ \varnothing 190

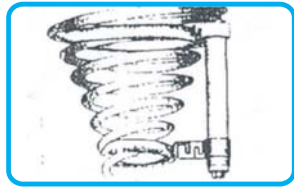
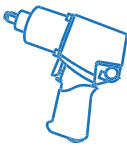

H.C.B-B1047 HEAVY DUTY MACPHERSON SPRING DAMPER EXTRACTOR (REPLACEABLE)

重力氣動麥花臣彈簧壓縮器

1 / 28.5 / 29.5 / 2'

- Break point : 66836 N (6820 kgt) (2,728 kgt)
- Max.Load : 26,000 N
- Max. working stroke : 317 mm
- Suitable for working with air impact.
- Safety design of free turning since overload is unacceptable.
- A square block for machinist's vice is attached to main body.
- 3 pairs of yellow covers help lacquered springs surface without damage. (Material: NYLON 66)
- Spring Specification :
 A: \varnothing 80 mm ~ 110 mm
 B: \varnothing 110 mm ~ 140 mm
 C: \varnothing 145 mm ~ 195 mm
- Application :
 Audi, Alfa Romeo, BMW, Chrysler, Citroen, Daihatsu, Ford, Fiat, Honda, Hyundai, Kia, Mazda, MB-A class, Mitsubishi, Nissan, Opel, Porsche, Peugeot, Renault, Land Rover, Saab, Seat, Skoda, Subaru, Suzuki, Toyota, VW, Volvo, Vauxhall....etc



BMW Chassis



H.C.B-A1047-F&G

BMW (E39/E46) SPRING DAMPER EXTRACTION / INSTALLATION TOOL KIT (CHANGEABLE)

BMW (E39/E46) 彈簧避震器拆裝工具組 (可換式)

- Used for fixing on the top of the spring cap, avoid falling off when working on spring.
- Two sizes for your choose. It is more safe and easy to use.
- Application : BMW E39/E46



H.C.B-A1047-1

SPECIAL VISE FOR SHOCK ABSORBER

麥花臣式彈簧拆裝工具固定座

- Attaching the pipe vise to the workbench allows repairs to be carried out quickly and cleanly.
- Struts should never be held in a normal workshop vise due to the risk of deforming the strut-tube.



H.C.B-A1047-2

SPECIAL VISE FOR SHOCK ABSORBER-RAPIDLY PAT. M390257

快速型麥花臣式彈簧拆裝工具固定座

- Clamped on the workbench for repairing instead of screwing.
- Both sides are with the same function.
- Struts should never be held in a normal workshop vise due to the risk of deforming the strut-tube.

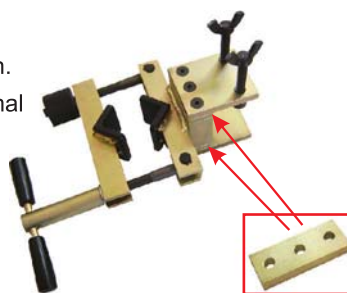

Replaceable pads increase the height of vise to fit the larger workbench.



H.C.B-A1047-H

EXTRA LARGE C JAW OF GM / CHRYSLER

GM / CHRYSLER 大 C 型配件

- Extra large Jaw 1pc for Chrysler
- Operation rang : 180-240 mm
- Only use with H.C.B-A1047





010
HWANG CHERNG BIN
Specialty Tools Inc.

BMW底盤修護工具
BMW Chassis Repair Tool

H.C.B-C1087

BMW (E36/E46/E85) REAR AXLES BUSH REMOVAL/INSTALLATION TOOL KIT USA PAT.

BMW (E36/E46/E85) 後羊角鐵套拆裝工具組

- This master kit which included in A1087 and B1087.
- This kit not only can remove/install old bushes but also new bushes .
- Save time and labor.



H.C.B-B1087

BMW (E46) REAR AXLE BUSH REMOVER /INSTALLER USA PAT.

BMW (E46) 後羊角鐵套拆裝工具組

Item No.	Product Name	Correspondence	Q'TY
B1087-1	Bearing Base	A1087-1	1
B1087-2	Bridge Piece	A1087-2	1
B1087-20	Force Nut (M12 x P1.75)		1
B1087-19	Force Screw (M12 x P1.75, L: 232mm, H:10mm)		1
B1087-5	Installer Plate	A1087-5	1
B1087-18	Thrust Plate		1
B1087-7	Lock Nut (M12 x P1.75)	A1087-7 (1 PCS)	2
B1087-17	Compressor Sleeve		1



BMW (E46) New Bush
Genuine Stock No.:
33 326 770 786



H.C.B-A1087



BMW (E36/E46/E85) REAR AXLES BUSH REMOVER/INSTALLER USA PAT.

BMW (E36/E46/E85) 後羊角鐵套拆裝工具組

4 / 20.7 / 22.5 / 1.68'



- Removal and replacement tool for metallic bushes on rear axles BMW type E36, E46, E85. To replace the mounting bushes without lowering the complete rear axle assembly.





H.C.B-A1070 **ON CAR** BMW (E38/E39/E52/E53/E60/E61/E63/E64/E65/E66/E67/E70) REAR AXLES BUSH REMOVER/INSTALLER USA.PAT.6389668

BMW (E38/E39/E52/E53/E60/E61/E63/E64/E65/E66/E67/E70) 後羊角鐵套拆裝工具

10 / 23.5 / 24.5 / 1.77'

- For removing and installing metallic bushes on rear axles.
- Application: BMW E38, E39, E52, E53, E60, E61, E63, E64, E65, E66, E67, E70.

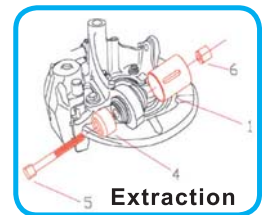
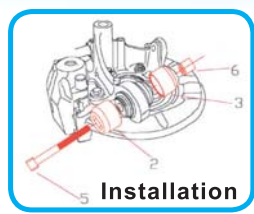
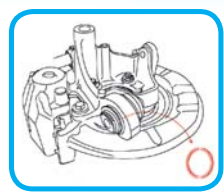

H.C.B-A1089 UNIVERSAL AXLES OIL PRESSURE EXTRACTOR (REPLACEABLE)

油壓輪軸拆卸組 (可換式)

2 / 30.5 / 31.7 / 0.9'

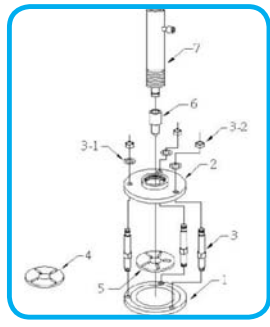

THE ILLUSTRATION OF TOOL

H.C.B-B1095-4H SLIDE HAMMER PULLER FOR HUB EXTRACTION (4 HOLES FOR JAPANESE CARS)

輪軸拔卸器 (4 孔, 日系車種)

2 / 18.5 / 20.5 / 1.48'

- Material of Main Body: SCM440
- Hardness: HRC 35°~40°
- Pull 4 bolts front hub on most of European vehicles easily.
- Application: most of European vehicles, Mercedes, BMW, AUDI, VW...etc.



H.C.B-B1095-5H BMW (E36/E46) SLIDE HAMMER PULLER FOR HUB EXTRACTION (5 HOLES FOR EUROPEAN CARS)

BMW 全車系輪軸拔卸器 (5 孔, 歐系車種)

2 / 18.6 / 20.6 / 1.48'

- Material of Main Body: SCM440
- Hardness: HRC 35°~40°
- Pull 5 bolts front hub on most of European vehicles easily.



H.C.B-C1095-5H

BMW (E36/E46) SLIDE HAMMER PULLER FOR HUB EXTRACTION (5 HOLES FOR EUROPEAN CARS)

BMW 全車系輪軸拆卸器 (5 孔, 歐系車種)

- Material of Main Body: SCM440
- Hardness: HRC 35°~40°
- Pull 5 bolts front hub on most of European vehicles easily.
- Application: Most of European vehicles, BENZ, BMW, AUDI, VW...etc.
- The slide hammer is 22.02 pounds.



H.C.B-D1095

UNIVERSAL HUB PULLER KIT (4 & 5 HOLES) (HYDRAULIC & SLIDE HAMMER)

萬用型輪軸拆卸器 (4 孔 & 5 孔) (油壓式 & 滑鎚式)

1 / 25.8 / 27 / 1.62'

- Material of Main Body: SCM440.
- Hardness: HRC 35°~40°
- Pull 4 & 5 bolts front hub on most vehicles easily.
- P.C.D. range: Ø96-126 mm
- Application:
 - 4H: TOYOYA, HONDA, ACCORD, MITSUBISHI..., most of Japanese vehicle
 - 5H: BENZ, BMW, AUDI, VW,...etc, most European vehicle
- The slide hammer is 22.02 pounds.
- This tool is used with pump, such as H.C.B-A1052-6, H.C.B-B1129, H.C.B-A3036, H.C.B-B3036.



H.C.B-A1132

ON CAR

BMW (E46/E85) REAR SUB-FRAME DIFFERENTIAL BUSH EXTRACTOR / INSTALLER USA PAT.

BMW (E46/E85) 差速器後三角架鐵套拆裝器

10 / 19.9 / 21 / 1.55'



- For replacement of the differential mounting metallic bushes in the rear sub-frame.
- Replacement of the mounting bushes without removing of the differential.



H.C.B-A1153

BMW (E46/E85) REAR SUSPENSION DIFFERENTIAL BUSH EXTRACTOR / INSTALLER USA PAT.

BMW (E46/E85) 工字標後橫樑差速器鐵套拆裝工具組

5 / 18.5 / 19.8 / 1.59'



- For replacement of the rear suspension differential bush.
- On car maintenance.
- Best tool for replacement of the bush on BMW E46.
- Application: most of European vehicles, BENZ, BMW (E46/ E85), AUDI, VW ... etc.



BMW (E46) differential bush
Genuine stock No.: 6751808 3000-04



REMOVAL



INSTALLATION





H.C.B-A1044-2 **BMW WHEEL STUD ALIGNMENT TOOL (M14 x P1.25)**

BMW 輪胎定位銷 (M14 x P1.25)

- To assist in mounting wheels, especially latest models with iron lug bolts.
- Application:

BMW		M14x1.25
Chassls	Model	Model Year
F10	5-Series	2010-Present
F11	5-Series	2010-Present
F01	7-Series	2009-Present
F02	7-Series	2009-Present
F25	X3	2011-Present
E70	X5	2007-Present
E71	X6	2007-Present
R50	MINI	From Jul 2006
R52	MINI	From Jul 2006
R53	MINI	From Jul 2006
R55	MINI	2007-Present
R56	MINI	2006-Present
R57	MINI	2009-Present



H.C.B-B2174 **BMW EMF BRAKE CALIPER WIND BACK KIT**

BMW EMF 煞車分泵調整組

- When replacing brake pads on newer BMWs with the Electromechanical Parking Brake (EMF) the rear brake caliper piston has to be turned while being compressed back into the caliper housing.
- Traditional methods of squeezing the piston back will not work as the piston must be screwed back in.
- Advantage:
Used to reset the EMF adjustment unit & piston to the starting position. This tool has three pins that lock into the piston and a 3/8" fitting for your ratchet. Simply ratchet the piston back in to reset it. This tool will prove to be invaluable in years to come as all BMW models will be switching over to this new EMF type of rear brake system.



- Application:
2010+ F07 BMW 535i GT, 535i xDrive GT, 550i GT, 550i xDrive GT
2011+ F10 BMW 528i 535i 535i xDrive 550i 550i xDrive M5
2012+ F06 BMW 640i Gran Coupe 650i Gran Coupe M6 Gran Coupe
2012+ F12 F13 BMW 640i 650i M6
2002-2008 E65 BMW 745i 745li 750i 750li 760i 760li
2009+ F01 BMW 740i 740li 750i 750li 750i xDrive 750li xDrive 760li
2011+ F25 BMW X3 xDrive28i X3 xDrive35i
2007+ E70 BMW X5 3.0si X5 4.8i X5 xDrive30i X5 xDrive35d X5 xDrive35i X5 xDrive48i X5M
2008+ E71 BMW X6 xDrive35i X6 xDrive50i X6M
2009+ Z4 BMW Z4 sDrive30i Z4 sDrive35i Z4 sDrive35is



H.C.B-A1647 **NEW** **BMW (E60) AFS GAUGE**

BMW (E60) AFS 校正器

- Must be used during wheel alignment to fix the steering shaft in place.
- New bracket and fork sent out to fit new models.
- Application: BMW E60
- **BMW OEM no. ref.:**83 30 0 494 655(324 150)



H.C.B-C1264

ON CAR

MINI COOPER (R50/R52/R53/R55/R56/R57/R58/R59) FRONT AXLE CONTROL ARM RUBBER MOUNT KIT

MINI COOPER (R50/R52/R53/R55/R56/R57/R58/R59)
前三角架橡皮座拆裝工具組

- For replacing the rubber mount (hydro-mounts) in left or right control arm.
- Application: R50/R52/R53/R55/R56 (mini cooper) (W10, W17, W11) (Bushing number # 31 12 6 757 561, 31 12 6 757 562)



■ BMW OEM no. ref.: 315150

NOTE: Please put the rubber mount on its correct direction before installation

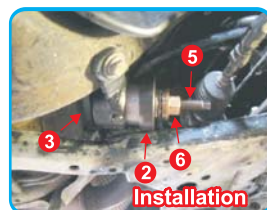

H.C.B-A1487

BMW (E81-E88,E90-E93,F2,M3) REAR TRAILING ARM BUSHING REMOVER/INSTALLER PAT.M459082

BMW (E81-E88,E90-E93,F2,M3) 後仰角鐵套拆裝工具組

- Use this tools to remove and install the bush.
- Application: BMW (E81-E88, E90-E93, F2, M3)



Rubber mount number:
33326763092 110867-10
Bush number: 26643 676



H.C.B-A1570

BMW (E90/M3) FRONT UPPER SUBFRAME BUSHING EXTRACTOR / INSTALLER KIT

BMW (E90/M3) 上三角台鐵套拆裝工具組

- Suitable for quick and simple removal and installation of the upper subframe bushing on BMW E90/M3.
- Can be used in-situ without removing the arm from the vehicle.
- Bush No. 31120393540K/31126763719
- Application: E82, E87 LC1, E88, E89, E90, E90 LC1, E91, E91 LC1, E92, E92 LC1, E93, E93 LC1, E84

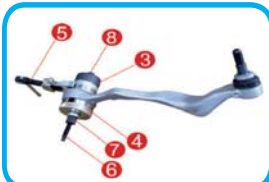

1. Bush No. 31120393540K/31126763719
2. New Bush No. 31102283579



H.C.B-A1216 BMW AXIAL CLEARANCE SEPARATOR (L TYPE)

BMW 仰角間隙撐開器 (L 型)

- To separate the axial clearance while taking down the axle.



H.C.B-A1206 BMW (E39) BALL JOINT SEPARATOR (24 mm)

BMW (E39) 球接頭拆卸器 (24 mm)

30 / 21.9 / 23.5 / 0.68'

- For splitting track-rod end, anti-roll bar mountings, ball joints... etc. Especially in confined space conditions like on BMW (E39).

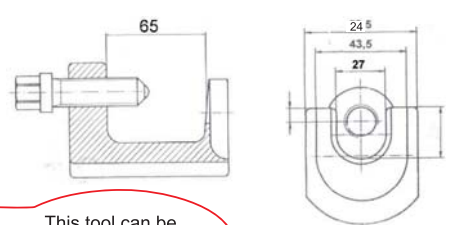
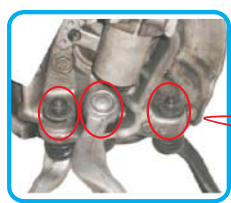

This tool can be used on all the three ball joints.

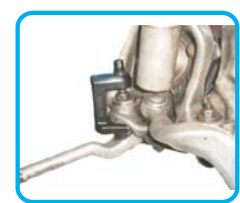

H.C.B-A1154 BMW (E28/E34) REAR SUB-FRAME DIFFERENTIAL BUSH REMOVER / INSTALLER USA PAT.

BMW (E28/E34) 後三角架鐵套拆裝工具組

5 / 12.6 / 13.8 / 1.59'

- For replacement of the rear sub-frame differential metallic bush.
- On car maintenance.
- Save time and money for maintenance.
- Application: BMW E28/E34.
- CAUTION: The bush and rear sub-frame differential are tightly installed. It is recommended to use a hammer to hit the rear end of the bush before using this tool.



Genuine stock No.: 33 32 9 061 946
BMW (E28,E34) REAR SUB-FRAME DIFFERENTIAL BUSH

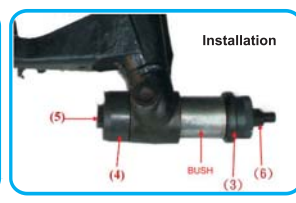
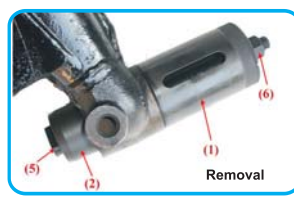
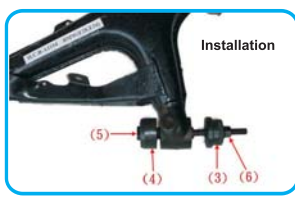

H.C.B-A1158 **ON CAR** **BMW (E46/E85) REAR SUSPENSION BUSH EXTRACTOR/INSTALLER PAT. M296813**

BMW (E46/E85) 後工字標鐵套拆裝工具組

4 / 19.8 / 21 / 1.5'

- Extractor for replacing the rear suspension mounting bushes.
- Replace the mounting bush without completely lowering the rear axle assembly.
- Application: BMW E46,E85.



BMW (E46/E85) rear suspension



The illustration of removal of F/L bush



The illustration of installation of F/L bush



The illustration of removal of F/R bush



The illustration of installation of F/R bush



The illustration of removal of rear bush



The illustration of installation of rear bush

H.C.B-B1201 **BMW (X1/X3/X5/X6) TRANSMISSION RUBBER MOUNT BUSH EXTRACTOR/INSTALLER**

BMW (X1/X3/X5/X6) 變速箱橡膠支座拆裝工具組

- Use to remove the transmission rubber mount bush.
- Application: BMW X3/E83,X5/E53/E70/E71,X5, 3000 c.c. before year 2003,X6/E70



Genuine stock:
2231342295



E53(X5) 2000~2003



E53(X5) 2003~2007



E70(X5)2007~2013
E71(X6)2008~2013



E83 X3 (2004~2010) · E46 4WD
E90 4WD · E60 4WD



H.C.B-A1201

BMW (X5) TRANSMISSION RUBBER MOUNT BUSH EXTRACTION / INSTALLATION TOOL KIT

BMW (X5) 變速箱橡膠支座拆裝工具組

4 / 22 / 23.2 / 1.28'



Fig 1

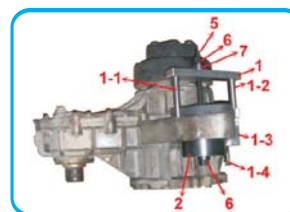

Fig 2

■ The Illustration for Removal:

- Step 1: Put accessory No. 1-3 into 1-2. Please refer to the removal illustration fig 1 for guidance.
- Step 2: Make sure clip the accessory No. 1-3 to the essence of the transmission, then put the accessory 1-1 into the outer breach of rubber mount to enable the central hole of accessory 1 and rubber mount to keep on a straight line. Then insert the accessory No. 5.
- Step 3: Install the bearing and nut on the both sides of accessory No. 5 after adjusting 1-4 and tightening 1-3.
- Step 4: To extract according to fig 2

■ The Illustration of Installation

- Step 1: To insert the locking pin of accessory No. 4 into the inner hole of rubber mount. Please refer to the install illustration fig 1 for guidance.
- Step 2: To complete the installation according to fig 2.



Fig 1

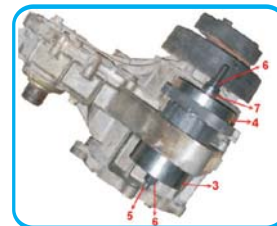

Fig 2

- Application: **BMW (X5, 3000 c.c.) before year 2003.**

H.C.B-A1185



BMW (E39) REAR SUSPENSION DIFFERENTIAL BUSH EXTRACTION/ INSTALLATION TOOL KIT

BMW (E39) 後工字樑差速器鐵套拆裝工具組

5 / 26.2 / 27.5 / 1.59'

BMW (E39) Front Differential Bush
Genuine stock: 33 17 1 090 389

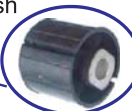

BMW (E38/E39) Rear Differential Bush
Genuine stock: 33 17 1 093 008

BMW (E39) Bushes

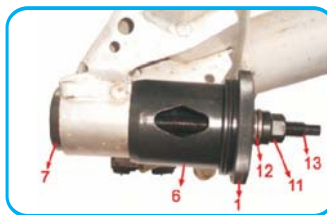

Removal

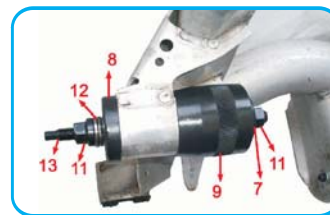

Installation

H.C.B-B1211 BMW (E39) SEDAN AND WAGON REAR SUSPENSION BUSH EXTRACTOR/INSTALLER KIT

BMW (E39) 轎車、休旅車後工字樑鐵套拆裝工具組

- On car maintenance.
- This kit contains the tools necessary to remove and install the rear axle carrier mount bushings on BMW E39 Sedan and Wagon.



Bush for BMW (E39) Wagon



Bush for BMW (E39) Sedan



Extraction for E39 Sedan



Installation for E39 Sedan

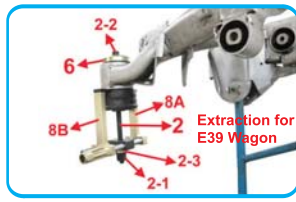

Extraction for E39 Wagon



Installation for E39 Wagon

H.C.B-A1211 **ON CAR** BMW (E39) REAR SUSPENSION BUSH EXTRACTOR / INSTALLER KIT

BMW (E39) 後工字樑鐵套拆裝工具組

4 / 17.2 / 18.2 / 1.5'

- On car maintenance.
- This kit contains the tools necessary to remove and install the rear axle carrier mount bushings on BMW E39 models.

Part No.	Description	Q'ty
1	Extraction Fixed Base	1
2	Bolt (M12*P1.75, M16*P2.0)	1
2-1	Nut (M16*P2.0)	1
2-2	Nut (M12*P1.75)	1
2-3	Bearing (#51103)	1
3	Extraction Pressure Piece	1
4	Installation Pressure Piece	1
5	Installation Fixed Base	1



Extraction for E39 sedan



Installation for E39 sedan



Genuine stock No.: 132441



H.C.B-A1258

ON CAR

BMW (E53) REAR SUSPENSION BUSH EXTRACTOR / INSTALLER

BMW (E53) 後工字樑鐵套拆裝工具組

4 / 24 / 25 / 1.5'

- Extractor for replacing the rear suspension mounting bushes. Replace the mounting bush without completely lowering the rear axle assembly.
- Application: BMW (E53).
- **Warning:** Keep the bolt and bush clean before using. Please smear grease on them.
- The bush arrow should be paralleled with the car itself. The max. inaccuracy is around $\pm 7^\circ$.

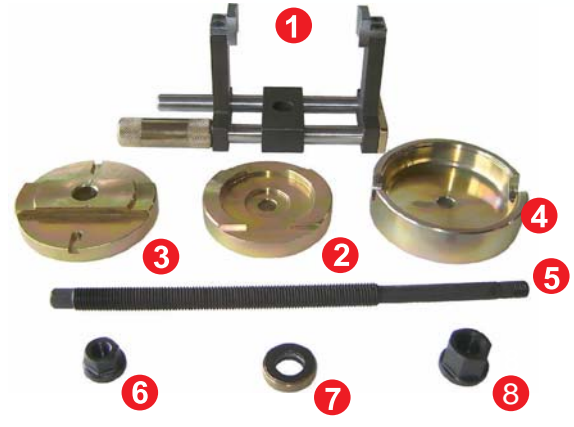

BMW (E53) REAR SUSPENSION



Genuine Stock No.:
33 31 6 770 454

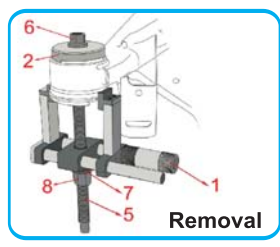

Removal



Installation

H.C.B-B1258

ON CAR

BMW X5 (E53) REAR SUSPENSION DIFFERENTIAL BUSH EXTRACTOR / INSTALLER

BMW X5 (E53) 後工字樑差速器鐵套拆卸工具組



Application tool (B1258)

- Extractor for replacement of the rear suspension mounting bushes. Replacement of the mounting bush without completely lowering the rear axle assembly.
- Application: BMW (E53).



Removal

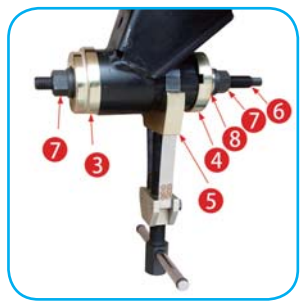

Installation-1

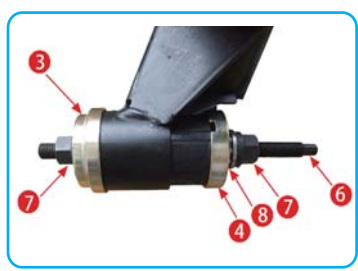

Installation-2

H.C.B-C1258 **ON CAR** **BMW X5 (E53) FRONT SUSPENSION DIFFERENTIAL BUSH EXTRACTOR / INSTALLER**

BMW X5(E53) 前工字樑差速器鐵套拆卸工具組



Application tool (B1258)



Removal

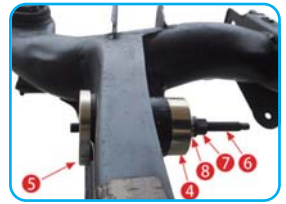

Installation

- Extractor for replacement of the front suspension mounting bushes.
Replacement of the mounting bush without completely lowering the rear axle assembly.
- Application: BMW (E53).



H.C.B-A1555 **BMW REAR DIFFERENTIAL SOCKET (PT55)**

BMW 後差速器套筒 (PT55)

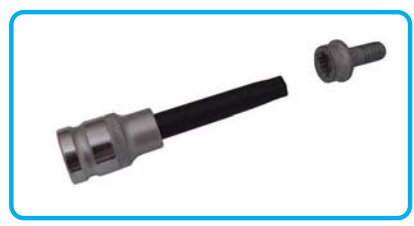

- For BMW rear differential.
- Application: BMW

H.C.B-B2293 **NEW** **BMW INNER BEARING RACE EXTRACTOR KIT**

BMW 軸承內圈環拆卸器

- Removal of the hub always leaves the inner race on the hub, but this extractor kit allows precise extraction of inner bearing race from the wheel hub.
- The race is impossible to remove without the correct special tool. If removal is operated by makeshifts, such as grinders, acetylene welding torch....., etc. may cause severe risks of personal injury or damage to the components.
- This new puller set allows quick and easy removal of inner bearing races.
- Application: E36/E46/E90

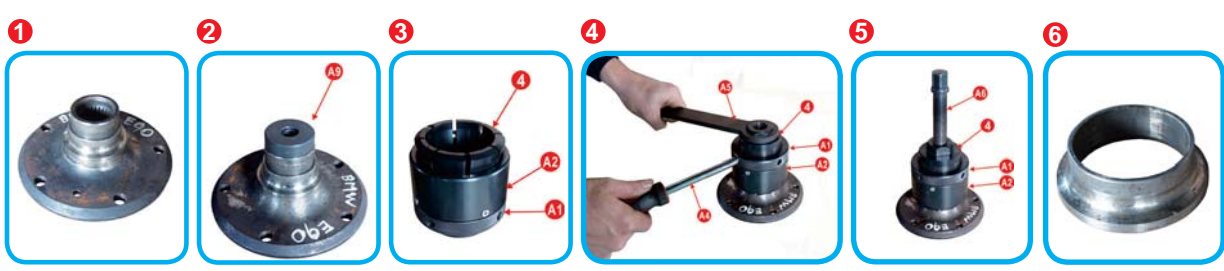



H.C.B-A1568 BMW (F01/02/F04/F06/F07/F10-F13/F18) DIFFERENTIAL REAR BUSH REMOVAL / INSTALLATION TOOL KIT

BMW (F01/02/F04/F06/F07/F10-F13/F18) 差速器 (後) 鐵套拆裝工具

H.C.B-B1568 BMW (F01/02/F04/F06/F07/F10-F13/F18) DIFFERENTIAL FRONT BUSH REMOVAL / INSTALLATION TOOL KIT

BMW (F01/02/F04/F06/F07/F10-F13/F18) 差速器 (前) 鐵套拆裝工具

H.C.B-A1588 BMW (F01/F02/F04/F06/F07/F10-F13/F18) REAR SUSPENSION BUSH REMOVAL / INSTALLATION TOOL KIT

BMW (F01/F02/F04/F06/F07/F10-F13/F18) 後工字標鐵套拆裝工具組

1 H.C.B-A1588 BMW (F01/F02/F04/F06/F07/F10-F13/F18) REAR SUSPENSION BUSH REMOVAL / INSTALLATION TOOL KIT

- To remove and install the rear suspension bushes.
- Application: BMW F01/F02/F04/F06/F07/F10-F13/F18.

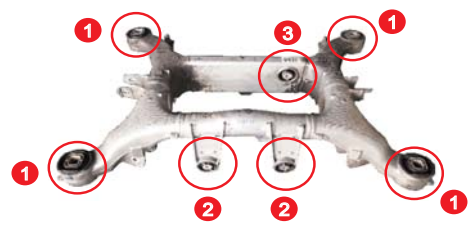

1. Bush no. 33 316 790 573 (FRONT)
2. Bush no. 33 316 793 864 (REAR)



FRONT BUSH REMOVAL



FRONT BUSH INSTALLATION



REAR BUSH REMOVAL

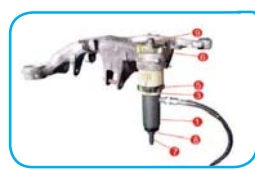

REAR BUSH INSTALLATION

2 H.C.B-A1568 BMW (F01/02/F04/F06/F07/F10-F13/F18) DIFFERENTIAL REAR BUSH REMOVAL / INSTALLATION TOOL KIT

- Suitable for the removal/installation of the rear differential bush on BMW F01.
- Application : BMW F01/02/F04/F06/F07/F10-F13/F18.
- Advantage: Bushes can be replaced without removal of the differential.



Bush number: 33 316 792 873



3 H.C.B-B1568 BMW (F01/02/F04/F06/F07/F10-F13/F18) DIFFERENTIAL FRONT BUSH REMOVAL / INSTALLATION TOOL KIT



Bush number: 33 316 792 873



- Suitable for the removal/installation of the rear differential bush on BMW F01.
- Application : BMW F01/02/F04/F06/F07/F10-F13/F18
- Advantage: Bushes can be replaced without removal of the differential.

H.C.B-A1458 BMW (E87/E90) REAR SUSPENSION BUSH EXTRACTION/ INSTALLATION TOOL KIT

BMW (E87/E90) 後工字樑鐵套拆裝工具組

- Extractor for replacement of the rear suspension mounting bushes. Replacement of the mounting bush without completely lowering the rear axle assembly.
- Application: BMW (E87/E90).



Genuine Stock No.:
33 31 6758 259



Genuine Stock No.:
33 31 6758 260



Removal

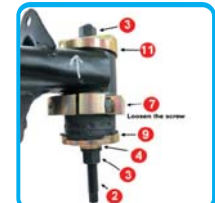

Installation

H.C.B-A1253 BMW OUTPUT SHAFT KIT

BMW 輪軸拆裝工具組

5 / 23.2 / 24.4 / 1.59'

- For removing and installing output shaft in drive flange as well as for removing front wheel bearing unit.
- Application: BMW E30, E31, E32, E36, E38, E39, E46, E52, E53, E60, E63, E64, E65, E66, E67, E83, E85, RR1, (On E53, conjunction with H.C.B-B1253)

CONTENTS & ASSOCIATED TOOLS:

- 1.HUB Puller Plate
- 2.Clamping Apparatus
- 3.Force Screw M20 * P1.5, Length: 150mm
Used to press output shaft out of drive flange, grip with tire iron in so doing.
Application: E30, E31, E32, E36, E38, E39, E46, E53, E65, E66, E67, E83, E85
- 4.Output Shaft Adaptor - M22 * P1.5.
Insert output shaft into drive flange. Application: E30
- 5.Output Shaft Adaptor – M27 * P1.5,
Insert output shaft into drive flange. Application: E31, E52, E53, E60, E61, E65, E66, E67, E83
- 6.Output Shaft Adaptor – M24 * P1.5,
Insert output shaft into drive flange. Application: E36, E46
- 7.Force Nut AND BEARING
- 8.Force SCREW
Application: E30, E31, E32, E36, E38, E39, E46, E52, E53, E60, E61, E65, E66, E67, E83, E85, RR1
- 9.Output Shaft Adaptor – M30 * P1.5



PRESSING OUTPUT SHAFT OUT



- Insert the Force Screw A1253-3 into the Force Screw A1253-7 and install through HUB Puller Plate A1253-1.
- Attach the Puller Plate A1253-1 securely to the drive flange with the original wheel studs.
- Screw special tool A1253-3, grip with tire iron A1253-2 and H.C.B-C1253, and then press output shaft out of drive flange.

INSTALLATION OF OUTPUT SHAFT



- Lightly oiled spline teeth of output shaft.
- Insert output shaft into drive flange.
- Select correct Output Shaft Adaptor A1253-4, 5, 6, 9 from special tool kit H.C.B-A1253 and screw onto output shaft.



- Screw on special tool A1253-1 with wheel studs.
- Draw in output shaft with special tool A1253-8 and A1253-3, grip with tire iron A1253-2 and H.C.B-C1253 in so doing.



H.C.B-B1253 BMW ALUMINUM ALLOY HUB WASHER

BMW 鋁合金輪軸墊塊

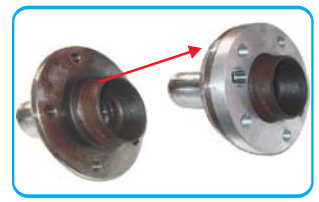

H.C.B-C1253 FLANGE HOLDING LEVER

支撐把手



H.C.B-D1253 BMW OUTPUT SHAFT EXTRACTOR/ INSTALLER KIT

BMW 輪軸拆裝工具組

3 / 21.6 / 22.8 / 2.39'

- This kit includes H.C.B-A1253, H.C.B-B1253 and H.C.B-C1253



H.C.B-A1048 BMW (E30/E36) LOWER CONTROL ARM BALL JOINT REMOVER/ INSTALLER

BMW (E30/E36) 三角架球接頭拆裝工具組

5 / 23.1 / 24.3 / 1.59'

- Removing and installing the ball joint with a hydraulic press.
- Application: BMW E30, E36.





010
HWANG CHERNG BIN
 Specialty Tools Inc.

BMW底盤修護工具
 BMW Chassis Repair Tool

H.C.B-B1294 BMW BALL JOINT PULLER (24 mm & 27 mm & 31 mm & 36 mm)

BMW 球接頭拆卸組 (24 mm & 27 mm & 31 mm & 36 mm)

- For quick and easy separation of ball joint connections.
- H.C.B-A1294-6 is particularly useful for control arms from steering knuckle. Special for E53, E83.
- Application: BMW E38, E39, E52, E53, E60, E61, E70, E83, E90, E91, E92, R50, R52, R53, RR1, RR2, X5,
- H.C.B-A1294-7 can be used on for Mercedes E-Class (W211), CLS (W219), S-Class (W220) and SL(W230) 、PORSCHE 996 、AUDI A4 、AUDI A6 Carrera lower suspension ball joint.
- H.C.B-A1294-9 can be used on BMW (E70) 、Land Rover



Parts No.	Description
A1294-1	compression bar 159L
A1294-2	base tool (27mm)
A1294-3	screw rod (M16×P1.5×11L)
A1294-4	hexagon Screws(H24,M20×P1.5×98L)
A1294-5	bearing (φ10×43L)
A1294-6	base tool (31mm)
A1294-7	base tool (24mm)
A1294-8	screw for Mini cooper
A1294-9	base tool (36mm)

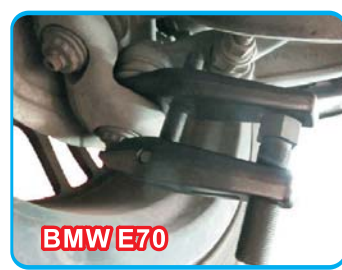

H.C.B-B1264 MINI COOPER (R50/R52/R53) LOWER CONTROL ARM FIXED BASE EXTRACTOR / INSTALLER

MINI COOPER (R50/R52/R53) 三角架固定座拆裝器

- Assembly tool like B1264 can extract/ install lower control fixed base when repairing the bushes from hydraulic mount
- Removing/ installing the bushes by H.C.B-C1264
- Application: MINI COOPER (R50/R52/R53)



BMW Chassis



H.C.B-D1332

BMW (E38/E39/E46/E53/E60/E61/E63/E64/E65/E66/E67/E81/E83/E85/E86/E87/E90/E91/E92/E93) FRONT CAMBER ADJUSTER KIT

BMW (E38/E39/E46/E53/E60/E61/E63/E64/E65/E66/E67/E81/E83/E85/E86/E87/E90/E91/E92/E93) 外傾角調整器

10 / 14 / 15 / 1.64"

- This kit includes A1332, B1332 and C1332.



H.C.B-A1332

BMW (E60/E61/E63/E64) FRONT CAMBER ADJUSTER

BMW (E60/E61/E63/E64) 外傾角調整器

- This adjuster is designed for adjusting front camber.
- Application: BMW E60/E61/E63/E64



H.C.B-B1332

BMW (E38/E39/E46/E53/E65/E66/E67/E81/E83/E85/E87/E90/E91/E92/E93) FRONT CAMBER ADJUSTER

BMW (E38/E39/E46/E53/E65/E66/E67/E81/E83/E85/E87/E90/E91/E92/E93) 外傾角調整器

- This adjuster is designed for adjusting front camber on late model 3 series with KDS.
- Application: BMW (E38/E39/E46/E53/E65/E66/E67/E81/E83/E85/E87/E90/E91/E92/E93)

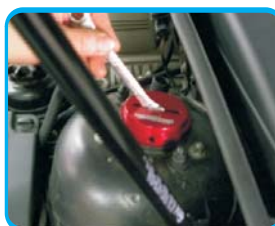

H.C.B-C1332

BMW (E38/E39/E46/E53/E65/E66/E67/E81/E83/E85/E86/E87/E90/E91/E92/E93) FRONT CAMBER ADJUSTER

BMW (E38/E39/E46/E53/E65/E66/E67/E81/E83/E85/E86/E87/E90/E91/E92/E93) 外傾角調整器

- Adjust the front camber on late model 3 series with KDS
- Application: BMW (E38/E39/E46/E53/E65/E66/E67/E81/E83/E85/E86/E87/E90/E91/E92/E93)





010
HWANG CHERNG BIN
 Specialty Tools Inc.

BMW底盤修護工具
 BMW Chassis Repair Tool

BMW Chassis

H.C.B-A1304 BMW BALL JOINT EXTRACTOR (24 mm)

BMW 球接頭拔卸器 (24 mm)

- For splitting track-rod ends, anti-roll bar mountings, ball joints....., etc, especially in small space conditions.
- Application: BMW E46, BENZ W211 / W220 / W168



H.C.B-B2189 BMW BRAKE CALLIPERS WIND BACK SOCKET (H7)

BMW 煞車卡鉗拆卸套筒 (H7)

- Size: Dr. 3/8" x H7
- Length: 36 mm
- Application: BMW
- Special designed to replace the brake lining.



H.C.B-A2278 6-POINT TAMPERPROOF™ SOCKET

六角超短起子套筒

- 6-Point Tamperproof™ socket. 1/4" Drive.
- Application: For engine control, air flow meter, generator, door panel in VAG, Volvo, Daimler-Benz, Ford



Part No.	Size
A2278-10T	10
A2278-15T	15
A2278-20T	20
A2278-25T	25
A2278-30T	30
A2278-35T	35
A2278-40T	40
A2278-45T	45
A2278-50T	50

H.C.B-A1455 BMW RIM LOCKS SOCKET (Dr. 1/2") (10T/17T/21T)

BMW 防盜螺絲套筒 (Dr. 1/2") (10T/17T/21T)

- Used on removal of rim screws when locked with original BMW rim locks.

ITEM NO.	Description
A1455-10	10Tx16.0mmx100mm(L)
A1455-17	17Tx14.5mmx100mm(L)
A1455-21	21Tx16.5mmx100mm(L)





010
HWANG CHERNG BIN
 Specialty Tools Inc.

BMW Chassis



H.C.B-A2288 BMW WHEEL LOCK SCREW SOCKET KIT (10 PCS)

BMW 防盜螺絲套筒 (10 PCS)

- This tool enables you to permit servicing of customer vehicles; even customer has lost the key.
- Contents: H17*13PT/15PT/16PT/17PT/18PT/19PT/20PT/21PT/22PT/23PT
- Applicable for installing and removing locks of BMW F series.
- Note : Maximum torque : Within 150 Nm°



H.C.B-B2288 BMW WHEEL LOCK SCREW SOCKET SET (20 PCS)

BMW 防盜螺絲套筒組 (20 PCS)



- Later style locking wheel nut kit (clover leaf style) for BMW F type models.
- Designed to fit OE style BMW Wheel Nuts with 17 mm socket drive:
 1 series F20/F21, 3 Series F30/F31, 4 Series F32/F34/F36, 5 Series F10/F11, 6 Series F12/F13, 7 Series F01/F02/F04.



H.C.B-C2288 VW WHEEL LOCK SCREW SOCKET KIT (23 PCS)

VW 防盜螺絲套筒組 (23 PCS)

- Not limited vehicles, the screw is random use in the car model from 2005~
- SCM440 with Harden and Chrome Planted
- Length: 30 mm, HEX: 17 mm
- Contents:
 22 pcs - #51/6PT, #52/7PT, #53/8PT, #54/9PT, #55/10PT, #56/11PT, #57/18PT
 #58/13PT, #59/14PT, #60/15PT, #61/16P, #62/17PT
 ABC0/10PT, ABC1/11PT, ABC2/13PT, ABC3/14PT, ABC4/15PT, ABC5/16PT
 ABC6/17PT, ABC7/19PTABC8/20PT, ABC9/21PT
 1 pcs: 1/2"dr 85 mmL H17 socket

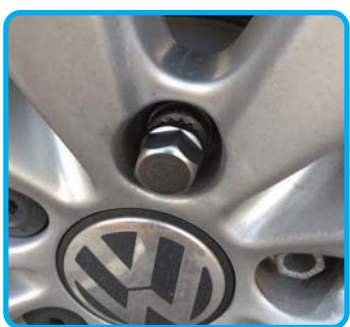



010
HWANG CHERNG BIN
Specialty Tools Inc.

BMW底盤修護工具
BMW Chassis Repair Tool

H.C.B-F1129

NEW

BMW (F01/F02/F07/F10/F11/F12/F13/F18) FRONT LOWER CONTROL ARM BUSH EXTRACTOR / INSTALLER (W/HYDRAULIC CYLINDER) (3/8" ADAPTOR) PAT.

BMW (F01/F02/F07/F10/F11/F12/F13/F18) 前下三角架鐵套拆裝工具組 (液壓式)(3/8" 接頭) PAT.

■ Character:

- Special design for precise bush installation which can install the bushes to the right position without the necessity of aligning the bush position afterwards.
- Driven by hydraulic system, this kit requires H.C.B-B1129 hand pump or H.C.B-A3036 air pump. After connecting with pump, this kit allows quick installation and fast, precise installation of new bushes.
- Can directly replace the bushes on car without disassembling the control arm.
- Application: BMW F01, F02, F07, F10, F11, F12, F13, F18



Removal:

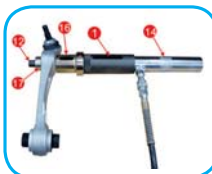

Removal:



Removal:

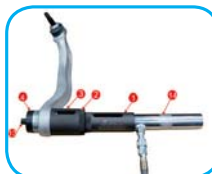

Removal:

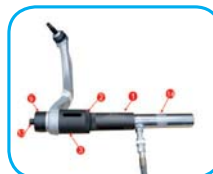

Installation:



Installation:



Installation:



Installation:



H.C.B-D1129

ON CAR

BMW (E31/E32/E34/E38/E39/E53/E60/E65/E66/E70/E90/E91/E92/E93/M3) UPPER SUB-FRAME BUSH EXTRACTOR / INSTALLER (HYDRAULIC) (3/8" ADAPTOR) PAT.

BMW (E31/E32/E34/E38/E39/E53/E60/E65/E66/E70/E90/E91/E92/E93/M3) 上三角台鐵套拆裝工具組 (液壓式) (3/8" 接頭)

- This kit contains hydraulic rams, pads and tubes.
- Use this kit to remove and install the metallic bushing on the upper subframe with hydraulic driven and on car maintenance.
- Hydraulic pump is not included. 10 tons one recommended.
- Conjunction with B1129 hydraulic hand pump, and using with B3036 when over oressure.



E32/E34 E38 E39 E53(X5) E60



E65/E66 E90/E92/E93/M3 E92 E70(X5)



You will also need to add :

H.C.B-A1554





H.C.B-B1129

HYDRAULIC HAND PUMP (3/8" ADAPTOR)

手搖幫浦 (3/8" 接頭)

- Optional : conjunction with H.C.B-A1129.
- B1129 is used for aluminum bush.
- A3036 is used for metal bush.



H.C.B-A1129

ON CAR

BMW (E31/E32/E34/E38/E39/E53/E60/E65/E66) UPPER SUB-FRAME BUSH EXTRACTION / INSTALLATION TOOL KIT (HYDRAULIC) (3/8" ADAPTOR) PAT. M277669 USA PAT.

BMW (E31/E32/E34/E38/E39/E53/E60/E65/E66)
上三角台鐵套拆裝工具組 (液壓式) (3/8" 接頭)

1 / 13.4 / 14.2 / 0.85"

- 5 series (E34, E39)
- 7 series (E32, E38, E65, E66)
- 8 series (E31)
- X5 (E53)
- BUSHINGS : E32, E31 - #31 12 1 136 607
- E34 - # 31 12 1 139 456
- E38, E39 - #31 12 0 006 482
- E53 - #31 12 1 096 372
- E65, E66 - #31 12 0 303 754

- This kit contains hydraulic rams, pads and tubes.
- Use this kit to remove and install the metallic bushing in the traction strut with hydraulic driven and on car maintenance.
- Hydraulic pump is not included.
- 10 tons recommended.
- Conjunction with B1129 hydraulic hand pump, and using with B3036 when over pressure



+ You will also need to add :
H.C.B-A1554



H.C.B-A1596

BMW (E46/E85) REAR SUSPENSION BUSH EXTRACTOR/INSTALLER

BMW (E46/E85) 後工字樑鐵套拆裝工具

- For replacement of the rear suspension mounting bushes.
- Replacement of the mounting bush without completely lowering the rear axle assembly.
- Application: BMW E46 / E85



H.C.B-B1596

NEW

BMW EXTENSION BAR

BMW 延長桿

- Extension bar for A1596





010

HWANG CHERNG BIN
Specialty Tools Inc.

BMW 引擎修護工具

BMW ENGINE REPAIR TOOL





H.C.B-A1019

BMW (M40/M43/M70/M73) CAMSHAFT ALIGNMENT TOOL

BMW (M40/M43/M70/M73) 正時工具組

18 / 22.1 / 22.8 / 0.82'

- Include: plate & locking pin for setting camshaft timing.
- Application : BMW M40, M43, M70, M73.
- **BMW OEM no. ref.:** 113 109 / 112 300.



H.C.B-M52TU

BMW (M52TU/M54/M56) CAMSHAFT ALIGNMENT TIMING TOOL MASTER KIT

BMW (M52TU/M54/M56) 凸輪軸正時工具組

- Application: M52TU engine (1999-2000 323i, 328i, 528i/ 1999-2003 Z3). M54 engine (2001-2005 325i, 330i, 525i, 530i, X5 3.0i/ 2001-2002 Z3/ 2003-2004 Z4/ 2004-2005 X3)
- **BMW OEM no. ref.:** 116150, 113292, 116180, 119340, 112300, 1134450, 113240, 1154900

Parts No.	Description
M52TU-1	BMW M50-TU (M52TU/ M54/ M56) double vanos setup bracket
M52TU-2	Secondary chain tensioner locking pin
M52TU-3	Secondary sprocket tool
M52TU-4	Primary chaintensioner tool
M52TU-5	Camshaft alignment tool
M52TU-6	Vanos compressed air fitting (U.S.standard)
M52TU-7	BMW (M42/ M50) camshaft alignment tool
M52TU-8	BMW (M50/ M52/ S50/ S52) sprocket extractor/installer

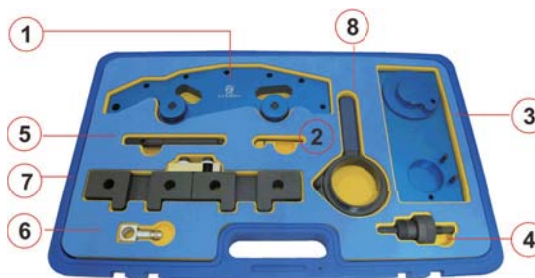

H.C.B-A1020

BMW CAMSHAFT ALIGNMENT TOOL

BMW 正時插銷 (全車系通用)

- To lock the fly-wheel and injection-pump pulley when changing timing chain or carrying out repairs.
- Application: M21, M40, M41, M42, M43, M43TU, M44, M47, M47TU, M50, M51, M52, M52TU, M54, M56, M57, M57T2, M57TU, M60, M62VAN, M62, M70, M73, S50B30, S50B32, S54 and S62.
- N.W.: 0.1 KG
- **BENZ OEM no. ref.:** 112300

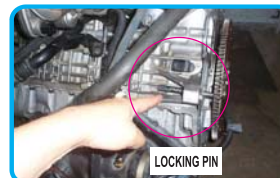

H.C.B-A1137

BMW (M50/M52/S50/S52) SPROCKET EXTRACTOR/INSTALLER

BMW (M50/M52/S50/S52) 正時齒輪拆裝器

- For turning sprockets when removing and installing vanos unit.
- Application: BMW Model M50/ M52/ S50/ S52.
- **BMW OEM no. ref.:** 115490

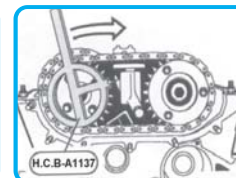

H.C.B-A1033 BMW (M42/M50) CAMSHAFT ALIGNMENT TOOL

BMW (M42/M50) 偏心軸正時工具

10 / 24 / 25 / 1.68'

- Align and hold the camshaft in position when assembling cylinder head and replacing timing chain.
- Use with camshaft alignment tool H.C.B-A1020 and rigid chain tensioner H.C.B-A1121-4
- Application: BMW (M42, M44, M50, M52, M52TU, M54, M56, S50US, S52US)
- BMW OEM no. ref.: 113240, 112300

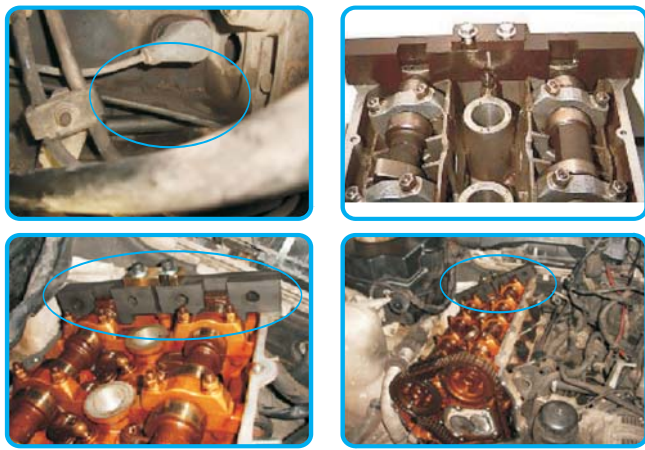

H.C.B-A1121 BMW (M52TU/M54/M56) TIMING TOOL

BMW (M52TU/M54/M56) 雙可變汽門正時工具組

5 / 18.4 / 19.8 / 1.59'

- This kit contains the tools necessary to assemble and properly time the double VANOS camshaft adjustment unit found in 1998 and later 6 cylinder engines.
- BMW OEM no. ref.: 116150, 113292, 116180, 1193340, 118200, 113450



H.C.B-B1121 BMW (M52TU/M54/M56) TIMING TOOL

BMW (M52TU/M54/M56) 雙可變汽門正時工具組

5 / 15.7 / 17 / 1.59'

- This kit contains H.C.B-A1121-1, H.C.B-A1121-2, H.C.B-A1121-3, H.C.B-A1121-4, H.C.B-A1121-1
- BMW OEM no. ref.: 113 390, 113 392, 116 150, 113 450, 116 180.





H.C.B-A1121-1 BMW (M50TU/ M52TU/ M54/ M56) DOUBLE VANOS SETUP BRACKET

BMW (M50TU/ M52TU/ M54/ M56) 雙可變汽門工具

- Adjusting plate for setting valve timing on engine with double VANOS.
- Combine with H.C.B-A1033
- Application:
M52TU engine (1999-2000 323i, 328i, 528i/1999-2002 Z3). M54 engine (2001-2005 325i,330i, 525i, 530i, X5 3.0i / 2001-2002 Z3 / 2003-2004 Z4 / 2004-2005 X3).



H.C.B-A1121-2 SECONDARY CHAIN TENSIONER LOCKING PIN

鏈條鬆緊器固定銷

- Lock chain tensioner during timing.
- Application: M50, M52

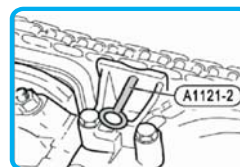

H.C.B-A1121-3 SECONDARY SPROCKET TOOL

扣鏈齒輪工具

- Use for preassembling secondary chain sprockets with chain on camshaft.
- Application: M52TU, M54, M56



H.C.B-A1121-4 PRIMARY CHAIN TENSIONER TOOL

鏈條鬆緊器

- Application: M52, M52TU, M54, M56



H.C.B-A1121-5 PULLER FOR CRANKSHAFT HUB

曲軸中心拉拔器

- Remove stuck vibraton damper hub in conjunction with H.C.B-A1133.
- Application: M52TU, M54, M56



H.C.B-A1121-6 VANOS COMPRESSED AIR FITTING (U.S. STANDARD) (OPTIONAL ACCESSORY)

氣壓連接頭 (美規) (選購配件)

- This fitting allows the functional testing of VANOS adjusting unit.
- Use to pressurize the single and double VANOS unit when checking or removing and replacing.
- Application: M50, M52, M52TU, M54, M56, N62



H.C.B-M62 **BMW (M62) VANOS CAMSHAFT TOOL KIT**

BMW (M62) 雙可變汽門正時工具組

3 / 23 / 24.1 / 2.39'



- **BMW OEM no. ref.:** 112 445, 112 441, 442, 112 446, 113 390, 112 300, 116 451, 116 452, 116 440, 116 420, 117 380, 113 310, 115 180.

Engine Code	Type	Size	Year/ Model
M60B30	Non-Vanos	2997c.c	1993-1995 E34 530i
30 8S 1			1992-1994 E32 730i
			1994-1996 E38 730i
M60B40	Non-Vanos	3982c.c.	1993-1995 E34 540i
40 8S 1			1992-1994 E32 740i
			1994-1996 E38 740i
			1992-1996 E31 840i
M62B35	Non-Vanos	3498c.c.	1996-1998 E39 535i
35 8S 1			1996-1997 E38 735i
M62TUB35	Single-Vanos	3498c.c.	1998-2002 E38 735i
35 8S 2			1997-2003 E39 535i
M62B44	Non-Vanos	4398 c.c.	1996-1998 E39 540i
44 8S 1			1996-1998 E38 740i
			1996-1997 E31 840Ci
M62TUB44	Single-Vanos	4398 c.c.	1998-2003 E39 540i
44 8S 2			1999-2001 E38 740i
			1999-2003 E53 X5 4.4i
M62B46	Single-Vanos	4619c.c.	2001 -2004 E53 X5 4.6i
46 8S 1			
Range Rover V8/44 8S 2	Single-Vanos	4400c.c.	2003-2005 Range Rover (02) 4.4
Morgan M62		4398c.c.	2000-2004 Aero 8

H.C.B-A1245 **BMW (M47T2/M54/M57TU/M57T2/M62/M62VAN/M67) TIMING PIN**

BMW (M47T2/M54/M57TU/M57T2/ M62/M62VAN/M67) 正時插銷

- Align flywheel to TDC position.
- Application: BMW M47T2, M54, M57TU, M57T2, M62, M62VAN, M67
- **BMW OEM no. ref.:** 115 180



H.C.B-A1021 **BMW (M60/M62) CAMSHAFT LOCKING FIXTURE**

BMW (M60 / M62) 偏心軸正時

5 / 23 / 24 / 1.59'

- Align and hold the camshaft in position when assembling cylinder head and replacing timing chain.
- Includes: 2 blocks swivel lock plate& locking pin for setting camshaft timing.
- Application: BMW M60&M62.
- **BMW OEM no. ref.:** 112445, 112441, 112442, 112446, 114230, 112300

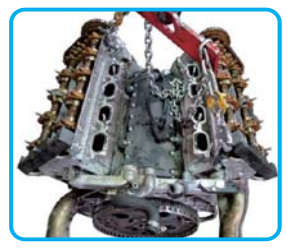

H.C.B-B1021 **BMW (M62) VANOS CAMSHAFT LOCKING FIXTURE**

BMW (M62) VANOS 凸輪軸正時工具組

5 / 10.1 / 11.4 / 1.59'

- Lock camshaft sensor wheel in position when timing and assembly of V8 VANOS equipped engines.
- Include left and right bank locking fixtures.
- Application : M62 VANOS (1999-2002)
- **BMW OEM no. ref.:** 116452, 116451

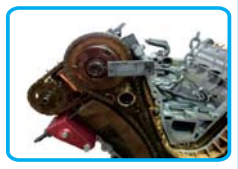



010
HWANG CHERNG BIN
Specialty Tools Inc.

SINCE 1990

BMW Engine



H.C.B-C1021

BMW (M62) VANOS TIMING SOCKET

BMW (M62) VANOS 凸輪軸套筒

- For adjusting VANOS to left stop during assembly as well for adjusting valve timing.
- Engine: M62 VANOS (1999-2002)
- **BMW OEM no. ref.:** 116 440



H.C.B-D1021

BMW (M62/M54) VANOS SOLENOID SOCKET

BMW (M62/M54) VANOS 電磁閥套筒

30 / 10.8 / 12.3 / 0.68'

- **BMW OEM no. ref.:** 116 420



H.C.B-E1021

BMW (M62) VANOS TENSIONING BRACKET

BMW (M62) VANOS 正時工具 - 托架

30 / 13.2 / 15 / 0.68'

- For screwing in chain tension with top right timing case cover removed.
- Engine: M62 VANOS
- **BMW OEM no. ref.:** 117 380

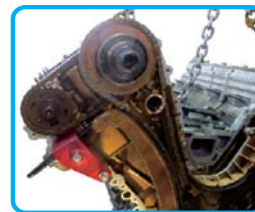

H.C.B-F1021

BMW (M62) SECONDARY CHAIN TENSIONER LOCKING SPRINGS (2 PCS/KIT)

BMW (M62) 鍊條鬆緊器固定彈簧

- For securing the camshaft chain tensioner.
- Application: BMW M62
- **BMW OEM no. ref.:** 113 310



H.C.B-G1021

BMW (M60) VANOS TENSIONING BRACKET

BMW (M60) VANOS 正時工具 - 托架

- For screwing in chain tension with top right timing case cover removed.
- Engine M60 VANOS
- **BMW OEM no. ref.:** 116440.

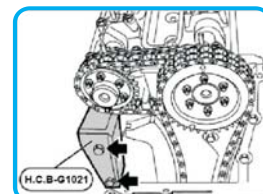

H.C.B-A1452

BMW (M60) CAMSHAFT INSERTION TOOL

BMW (M60) 凸輪軸正時工具

- Used to check camshaft position after insertion.
- Application: BMW (M60)
- **BMW OEM no. ref.:** 112 430

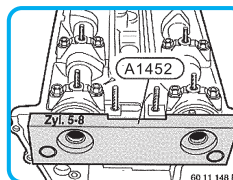

Check installation position with A1452.
NOTE: Cylinder designation 5-8 on A1452 point upwards.

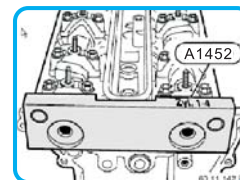

Check installation position with A1452.
NOTE: Cylinder designation 1-4 on A1452 point upwards.

H.C.B-A1088

BMW CAMSHAFT ALIGNMENT TOOL KIT

BMW 綜合正時工具組 (全車系)

4 / 29.4 / 30.6 / 1.8'

- For BMW engine models M42&M50: Include 2 blocks swivel lock plate & locking pin for setting camshaft timing.
- For BMW engine models M40 & M70: Include plate & locking pin for setting camshaft timing.
- For BMW engine models M60 & M62: Include 2 blocks swivel lock plate & locking pin for setting camshaft timing.
- **BMW OEM no. ref.:** 113 190, 112 300, 112 445, 112 441, 112 442, 112 446, 113 390, 113 240, 114 120

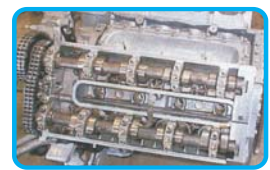

H.C.B-A1118

BMW (E36/E39/E46), BENZ (W211/W203), VW, EUROPEAN CARS FUEL TANK LID REMOVER/ INSTALLER

BMW (E36/E39/E46), BENZ (W211/W203), VW, 歐洲車種汽油油箱蓋拆裝器

20 / 21.7 / 24.2 / 1.03'

- Remove the tank while fixing or replacing the fuel tank.
- This tool will help you remove the tank lid easily.
- Application:
BMW (E36/E39/E46), BENZ (W211/W203), BENZ ML 230(163 136), ML 320 (163154), ML 350(163 157), ML 430(163 172), ML 55 AMG(163 174), ML 500(163 175), VW European cars.

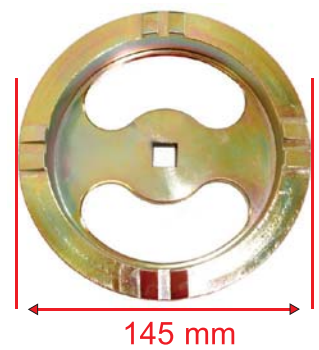

Separate tool

Extract BENZ fuel tank

Install

H.C.B-A1476

BMW MOTORCYCLE OIL FILTER WRENCH (75 mm)

BMW 機車機油芯扳手 (75 mm)

- Application: BMW motorcycle
- **BMW OEM no. ref.:** 114 660/661





H.C.B-A1130

BMW (N20/N26/N40/N42/N45/N46/N52/N55/N63) OIL FILTER WRENCH (Dr. 1/2", 16 POINTS, 86 mm)

BMW (N20/N26/N40/N42/N45/N46/N52/N55/N63)
機油芯扳手 (Dr. 1/2", 16 角, 86 mm)

50 / 9.7 / 12 / 2.8'



- Dr. 1/2", 16 points, 86 mm
- Application: BMW (316i, 318i ab '01 etc), most all newer Volvo models S40 / V50 (2004.5 +), C70 (2006+), C30 (2008+), S80 (2007+) with 3.2 6-cyl or 3.0 T6, V70 / XC70 (2008+) with 3.2 6-cyl or 3.0 T6, XC90 (2007+) with 3.2 6-cyl, XC60 (2010+) with 3.2 6-cyl or 3.0 T6.
- **Caution:** Please use 27 mm socket with a wrench to manipulate the tool when the torque is over 25 Nm, otherwise the tool will risk being broken. The torque value value limit is 25 Nm if the tool is operated with a wrench.
- **BMW OEM no. ref.:** 119 240

H.C.B-N62&N73

BMW (N62/N73) TIMING TOOLS

BMW (N62/N73) 正時工具組

3 / 15.5 / 16.5 / 2.6'



- Include: H.C.B-A1136-1, A1136-2, A1136-3, A1136-4, A1136-5, A1136-6, A1136-7, A1136-8, A1136-9, A1136-10 and A1136-11.
- **BMW OEM no. ref.:** 119461, 119452, 119340, 117270, 119451, 113460, 119454, 119453, 119190, 119462, 119463.

H.C.B-B1136

BMW (N62/N62TU/N73) CAMCARRIER TOOL KIT

BMW (N62/N62TU/N73) 凸輪軸托架工具組

- Include :
H.C.B-B1136-1 Base plate
H.C.B-B1136-2 Shaped section
H.C.B-B1136-3 Knurled nut
H.C.B-B1136-4 Retaining screws (2 PCS)
H.C.B-B1136-5 Guide bushes (2 PCS)
- For securing inlet camshaft during installation in bearing bridge.
- **BMW OEM no. ref.:** 119 470

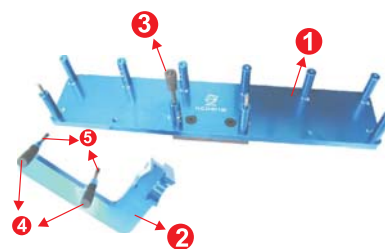

H.C.B-A1136

BMW (N62/N73) CAMSHAFT ALIGNMENT TOOL

BMW (N62/N73) 正時工具組

5 / 13.3 / 14.5 / 1.59'

- **H.C.B-A1136-1&H.C.B-A1136-2 camshaft alignment tool**
For locating camshaft in TDC position when checking or adjusting camshaft timing on BMW N62, N62TU, N73, E53 (X5 4.4i, 4.8is), E60(540i, 545i, 550i 0, E61(545i, 550i), E63 (645 Ci, 650), E64(645Ci, 650i), E65(735i, 740i, 745i, 750i, 760i, AlpinaB7), E66(735Li, 740Li, 745Li, 750Li, 760Li), E70(X5 4.8i).
- **H.C.B-A1136-3 Holder with Screw**
For checking or adjusting camshaft timing on BMW N62, N62TU, N73.
- **H.C.B-A1136-4 Plug mandrel**
For locking flywheel in TDC position on BMW N40, N42, N62, N62TU, N73.
- **BMW OEM no. ref.:** 119461, 119462, 119463, 119190, 119340, 117270, 119452, 119451, 119453, 119454, 113460





010
HWANG CHERNG BIN
 Specialty Tools Inc.

BMW引擎修護工具
BMW Engine Repair Tool



H.C.B-A1136-5 **BMW (N20/N26/N40/N42/N45/N46/N52/N55/N62) CHAIN TENSIONER (OPTIONAL ACCESSORY)**

BMW (N20/N26/N40/N42/N45/N46/N52/N55/N62) 鏈條鬆緊器 (選購配件)

- To tension primary chain.
- Short format for late model new generation engines.
- Application: BMW (N40/ N42/ N45/ N46/ N52/ N62)
- BMW V8 engine needs two set of H.C.B-A1136-5 in the same time.
- **BMW OEM no. ref.:** 119 340

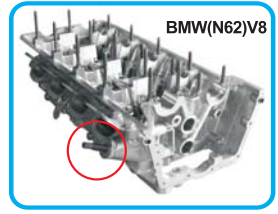

H.C.B-A1136-6 **BMW (N73) LEFT CYLINDER HEAD SOCKET**

BMW (N73) 左側氣缸蓋拆裝套筒

- To remove and install the left cylinder head socket.
- Application: BMW N73



H.C.B-A1136-7 **BMW (N62/N62TU/N73) GASKET & BOLT**

BMW (N62/N62TU/N73) 墊圈 & 螺絲

- Height of A1136-7-1: 22.5 mm
- Size of A1136-7-2: M10.
- Screws A1136-7-1 and A1136-8 to oil pan by H.C.B-A1136-7-2.



H.C.B-A1136-8 **BMW (N62/N62TU/N73) FIXING CRANKSHAFT WRENCH**

BMW (N62/N62TU/N73) 固定曲軸扳手

- Work with A1136-10 when removing / installing crankshaft

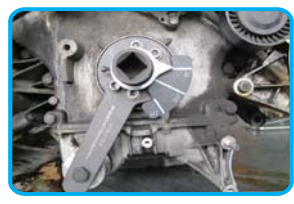

H.C.B-A1136-9 **BMW (N62/N62TU/N73) ANGLE INDICATOR**

BMW (N62/N62TU/N73) 角度指針

- Indicate the angle on A1136-11
- Use A1136-10 to fix this tool

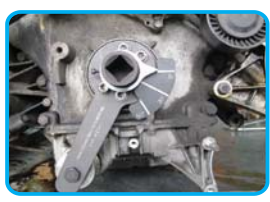

H.C.B-A1136-10 **BMW (N62/N62TU/N73) SOCKET (27 mm)**

BMW (N62/N62TU/N73) 套筒 (27 mm)





H.C.B-A1136-11

BMW (M60/M62/M73/N62/N62TU/N73) ANGLE POSITION GAUGE

BMW (M60/M62/M73/N62/N62TU/N73) 角度盤

- Graduated disk for mounting on counter holder on for torque central bolt.
- Application: BMW M60, M62, M73, N62, N62TU, N73

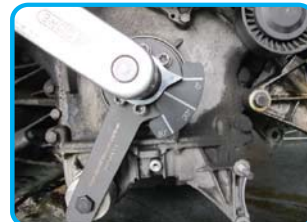

H.C.B-C1136

BMW (N62/N73) VALVETRONIC TORSION LEVER

BMW (N62/N73) 汽門彈簧扭轉扳手

- Used to pretension and relieving the valvetronic torsion springs.
- Application: BMW N62/N73
- BMW OEM no. ref.: 119 480



H.C.B-B1451

NEW

BMW (N63/N74/S63) TIMING TOOLS

BMW (N63/N74/S63) 正時工具組

Parts No.	BMW OEM no. ref.	Description
B1451-A	119890	Gauge
B1451-B	118090	Brace
B1451-C	118570	Alignment Tool
B1451-D	119190	Plug Mandrel
B1451-E	83302249162 (#2249162)	Camshaft Timing Tool

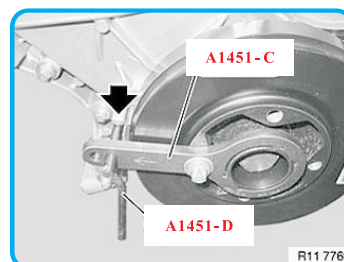
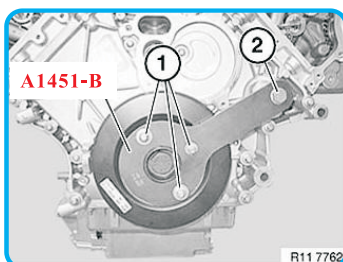
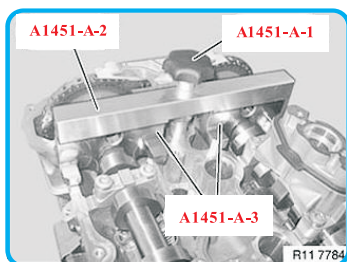

H.C.B-A1451

BMW (N63/N74/S63) TIMING TOOLS

BMW (N63/N74/S63) 正時工具組

Parts No.	BMW OEM no. ref.	Description
A1451-A	119890	Gauge
A1451-B	118090	Brace
A1451-C	118570	Alignment Tool
A1451-D	119190	Plug Mandrel

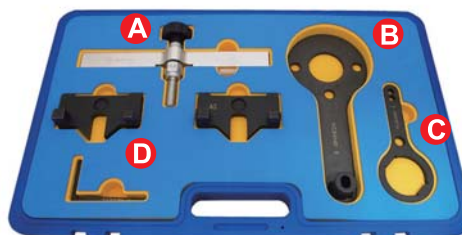

H.C.B-A1593

BMW (N63/S63) CAMSHAFT ALIGNMENT TOOL KIT

BMW (N63/S63) 凸輪軸正時工具組

- Special designed to locate the camshaft in TDC position.
- For checking and adjusting the timing chain tensioner.
- Application: N63 engine (After Sep. 2012)
For BMW S63 Engine:
S63B44O0
E70 X5M (2010-2013)
E71 X6M (2010-2013)
Wiesmann GT MF5 (2011-present)
F02 760 LI (2011/9-present)
S63b44T0
F10 M5 (2011-present)
F12 M6 (2012-present)
F13 M6 (2012-present)
F06 M6 Gran Coupe (2013-present)
- The S63 is BMW Motorsport division version of the N63, which is debuted in the BMW X6M.
The S63 uses two twin-scroll turbochargers plus a pulse tuned, cross-engine exhaust manifold to keep constant exhaust pulses flowing to the turbo S at every 180 degree rotation.
Special designed to locate the camshaft in TDC position for checking and adjusting the timing chain tensioner.
- BMW OEM on. ref. :
83302249117 (#2249117)
83302249140 (#2249140)
83302249144 (#2249144)
83302249159 (#2249159)
83302249162 (#2249162)
11 8 570 Vibration Damper Lock
11 9 190 Plug Macdrel / Timing Pin

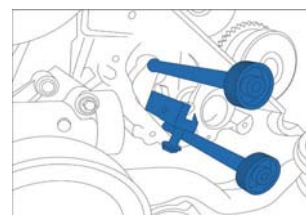
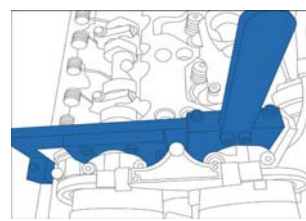
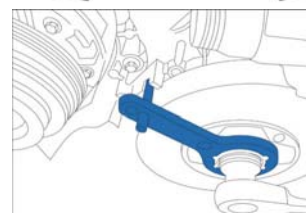

H.C.B-A1656

NEW

BMW (N63) INJECTOR REMOVAL TOOL

BMW (N63) 噴油嘴拆卸工具

- Used for removing stuck injectors on BMW N63 engines.
- Application: N63/S63/N43 engine, N63 (2008-2012)
- BMW OEM no. ref.: 130 300

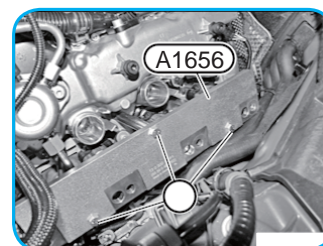

H.C.B-A1331

BMW (M60/M62) CRANKSHAFT PULLEY HOLDING TOOL

BMW (M60/M62) 曲軸支撐扳手

- To hold crankshaft and remove central bolt.
- Application: M60, M62, Range Rover V8 4.4 petrol engine
- Works with H.C.B-A1136-11
- BMW OEM no. ref.: 112450.

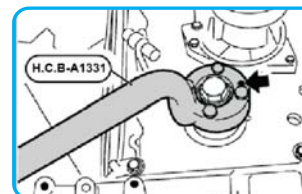



H.C.B-A1204

BMW A/C COMPRESSOR CLUTCH REMOVER

BMW 冷氣壓縮機離合器拆卸器

- To remove the plate of clutch.
- Application: Most of BMW cars



H.C.B-A1138

BMW WINDSHIELD WIPER ARM REMOVER

BMW 雨刷臂拆卸工具組

30 / 16.4 / 18 / 0.68'

- To remove BMW serial models windshield wiper arm.
- Support arms are adjustable to fit variety of automobiles.
- Easy to use. Save your time.
- Application: E12, E21, E23, E24, E28, E30, E30/C, WAGON E30, E31, E32, E32/3, E34, WAGON E34, E36, E36/2, E36/3, E36/5, E36/7, E36/C, WAGON E36, E38, E38/3, E39, E39PL, WAGON E39, E46, E46/16, E46/2, E46/3, E46/5, E46/C, E52, E53, E60, E65, E66, E67, E85, RR1.



H.C.B-A1133

BMW (M52TU/M54/M56) CRANKSHAFT HUB LOCKING TOOL

BMW (M52TU/M54/M56) 曲軸支撐扳手

6 / 22.4 / 26.4 / 2.65'

- Use H.C.B-A1133-1 with vibration damper braces H.C.B-A1133-2 to release and tighten the center retainer bolt.
- Application: 6 Cylinder Engines M52TU, M54, M56

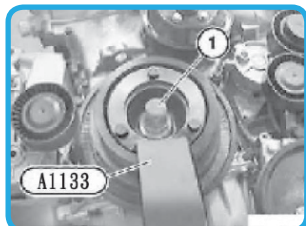

1. Put HCB-A1133 in the pulley to extract screw (1) and washer by fixing the pulley and by driving the wrench.

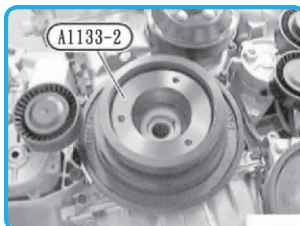

2. In Order To Extract The Pullet, Put In HCB-A1133-2 to 1 of the picture in step 2.



3. Then Combine HCB-A1121-5 and HCB-A1133-2

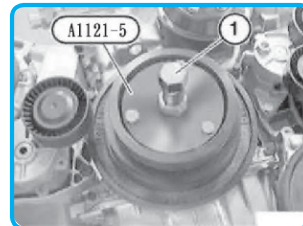

4. Finishing the combination of HCB-A1121-5 and HCB-A1133-2.

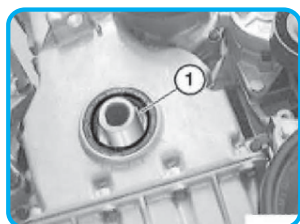

5. Pulley is extracted.

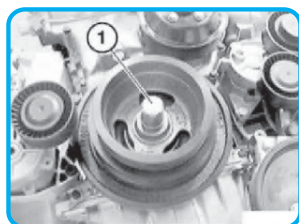

6. Put new screw (1) and washer.

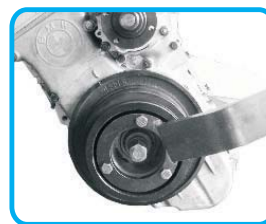

7. Use HCB-A1133 to fix screw into the pulley.

H.C.B-A1453

BMW (W11/W17) CRANKSHAFT HOLDING TOOL

BMW (W11/W17) 曲軸支撐扳手

- For the vibration damper when releasing and tightening down the central bolt.
- Applicable engine: R50 (W17) 2002-2006, R52 (W11) 2003-2008, R53 (W11) 2001-2007.
- **BMW OEM no. ref.:** BMW 118 460

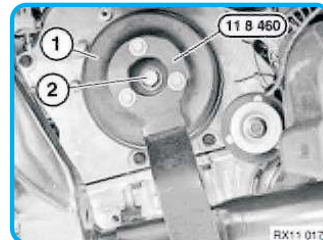

H.C.B-A2080

BMW (E31/E38/E39) WIPER LINKAGE ASSEMBLY SOCKET (T80)

BMW (E31/E38/E39) 兩刷連桿組套筒 (T80)

- Requirement:
Windshield wiper arm removed.
T80 (1/2" SQUARE DRIVE EXPERT DRAPER TX STAR IMPACT SOCKET BIT)
- For removing and installing BMW (E31, E38, and E39) wiper linkage assembly.
- Used in conjunction with H.C.B-A1138.
- Application: E12, E21, E23, E24, E28, E30, E30/C, WAGON E30, E31, E32, E32/3, E34, WAGON E34, E36, E36/2, E36/3, E36/5, E36/7, E36/C, WAGON E36, E38, E38/3, E39, E39PL, WAGON E39, E46, E46/16, E46/2, E46/3, E46/5, E46/C, E52, E53, E60, E65, E66, E67, E85, RR1...ETC.



H.C.B-A1156

BMW (N42/N46/N46T) CAMSHAFT ALIGNMENT TOOL

BMW (N42/N46/N46T) 正時工具組

5 / 11.2 / 12.5 / 1.59"

- This tool is a gauge for fixing the camshaft at the TDC position.
- To dismantle and assemble intake and exhaust camshaft.
- Application: BMW (N42/N46)
- H.C.B-A1156-1
BMW (N42/N46) EXHAUST CAMSHAFT SETTING PLATE
BMW OEM no. ref.: 119290/291
- H.C.B-A1156-2
BMW (N42/N46) INLET CAMSHAFT SETTING PLATE
BMW OEM no. ref.: 119290/292
- H.C.B-A1156-3
BMW (N42/N46) FIXING SCREW
BMW OEM no. ref.: 119290/293
- H.C.B-A1156-4
BMW (N40/N42/N62TU/N62/N73) FLYWHEEL TDC LOCKING PIN
BMW OEM no. ref.: 119190

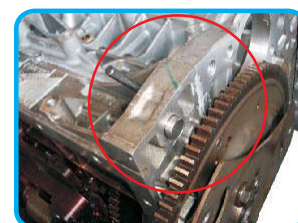
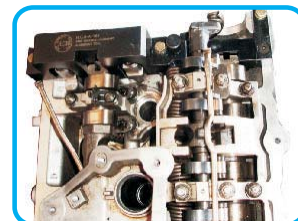
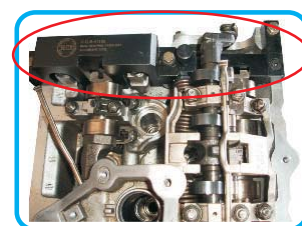



H.C.B-A1156-5

BMW (N42/N46/N46T) INTAKE/EXHAUST CAMSHAFT GAUGE

BMW (N42/N46/N46T) 進 / 排氣前凸輪固定座

- For disassembling or realigning the camshaft.
- Application: BMW (N42/N46)



H.C.B-A1156-6

BMW (N42/N46/N46T) CAMSHAFT TURNING WRENCH

BMW (N42/N46/N46T) 旋轉凸輪軸扳手

- Used to turn camshaft.
- Application: BMW N42, N46, N46T



H.C.B-A1156-7

BMW (N42/N46/N46T) INLET CAMSHAFT FIXTURE

BMW (N42/N46/N46T) 偏心軸 / 凸輪軸固定支架

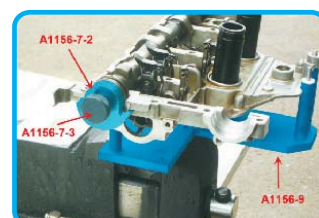

- Fixing the camshaft to the bracket.
- Application: BMW N42, B46, N46T

H.C.B-A1156-8

BMW (N42/N46/N46T) INTERMEDIATE LEVER CLAMP

BMW (N42/N46/N46T) 中間槓桿固定夾

- Clamping the intermediate lever.
- Application: BMW N42, N46, N46T



H.C.B-A1156-9

BMW (N42/N46/N46T) CAMSHAFT BRACKET MOUNTING FIXTURE

BMW (N42/N46/N46T) 凸輪軸拆裝托架

- Assembling this tool and clamping it by a suitable vice.
- Application: BMW N42, N46, N46T



H.C.B-A1156-10

BMW (N42/N46/N46T) INTAKE/ EXHAUST CAMSHAFT GAUGE

BMW (N42/N46/N46T) 進 / 排氣前凸輪固定座

- For removing and installing intake and exhaust camshaft adjustment unit.
- Application: BMW N42, N46, N46T.



H.C.B-A1156-11

BMW (N42/N46/N46T) TORSION SPRING REMOVER/INSTALLER

BMW (N42/N46/N46T) 扭力彈簧拆卸器

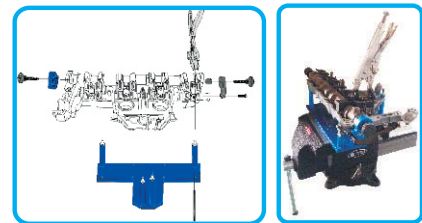

H.C.B-A1156-12

BMW (N42/N46/N46T) SPRING REMOVAL / INSTALLATION PLIERS

BMW (N42/N46/N46T) 扭轉彈簧鉗

- An assistant to remove/ install the spring on the cylinder head of camshaft.
- Before removing the spring, fix A1156-12 in the positioned plate and loosen the bolt.
- Open A1156-12 carefully, unloaded the spring and take it off.
- Close A1156-12 to tighten the spring while installing it. Then match the bolt to hole, and locked.
- Application: BMW N42/ N46.

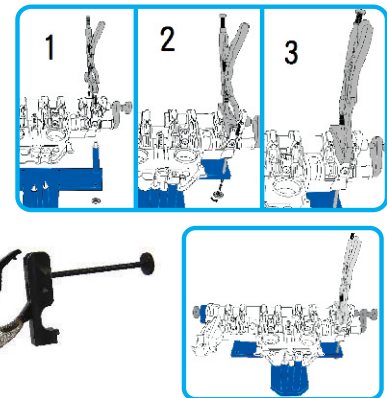

H.C.B-B1156

BMW (N42/N46/N46T) PETROL TIMING TOOL KIT

BMW (N42/N46/N46T) 正時工具組

5 / 19.5 / 20.5 / 2.02'

- Using with H.C.B-C1156. This kit includes H.C.B-A1156-1, H.C.B-A1156-1-1, H.C.B-A1156-2, H.C.B-A1156-3, H.C.B-A1156-4, H.C.B-A1156-6, H.C.B-A1156-10 and H.C.B-A1136-5.
- For timing, checking and adjusting the twin camshaft on petrol engine.
- For removing, installing and aligning of Vanos unit.
- Application: BMW
 - E87 (1 Series): 118i / 120i N46 engine
 - E46 (3 Series): 316i / 316Ti / 318i / 318Ti (01-) N42/N46 engine
 - E90/E91: 318i / 320i N46 engine
 - E85: Z4, 2.0L – N46 engine
 - E83: N46 engine





H.C.B-C1156

BMW (N42/N46/N46T) CAMSHAFT CARRIER BRACKET REMOVAL / INSTALLTION TOOL KIT

BMW (N42/N46/N46T) 正時工具組

3 / 14 / 15.2 / 3.28'



- Used with H.C.B-B1156.
- This kit includes H.C.B-A1156-7, H.C.B-A1156-8, H.C.B-A1156-9, H.C.B-A1156-11.
- For installation, removal and timing of variable camshaft timing unit / camshafts.
- For checking and adjustment of camshaft timing.
- Application: BMW: E87 (1 Series): 118i / 120i – N46 engine
E46 (3 Series): 316i / 316Ti / 318i / 318Ti (01-) – N42/N46 engine
E90/E91: 318i / 320i – N46 engine
E85: Z4, 2.0l – N46 engine
E83: N46 engine

H.C.B-A1188&A1188-3

BMW (N51/N52) TIMING TOOLS & PLUG MANDREL

BMW (N51/N52) 正時工具組附插銷

4 / 23.3 / 24.2 / 3.28'



- The kit includes:
H.C.B-A1188-1, H.C.B-A1188-2, H.C.B-A1188-3

H.C.B-A1188-1

BMW (N51/N52) CAMSHAFT ALIGNMENT TOOL

BMW (N51/N52) 正時工具 (含量規, 適配器, 卡座)

- For locating camshaft at the TDC position
- Application : BMW N51, N52

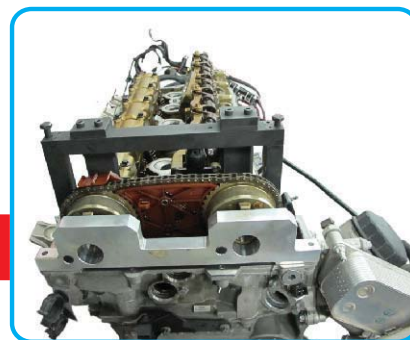
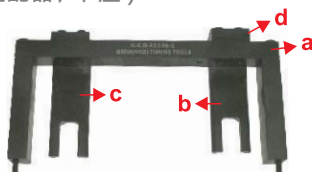

H.C.B-A1188-2

BMW (N51/N52) CAMSHAFT FIXING BASE

BMW (N51/N52) 凸輪軸固定座



H.C.B-A1188-3

BMW (N51/N52/N52K/N53/N54) PLUG MANDREL

BMW (N51/N52/N52K/N53/N54) 正時插銷

- For locking flywheel in TDC position on BMW N51, N52, N52K, N53, N54.
- Turn crankshaft to TDC position while central bolt moves.
- Put HCB-A1188-3 into calibrate hole (arrow ahead) and fixed crankshaft.
- Attention:
 1. There is a big hole make use of TDC position nearby calibrate hole.
 2. When HCB-A1188-3 stayed in calibrate hole and locked flywheel, it is impossible to move engine through central bolt.

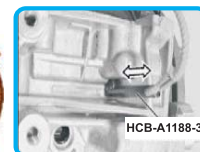

H.C.B-A1188-4 BMW (N53/N54) CAMSHAFT FIXING BASE

BMW (N53/N54) 凸輪軸固定座

- To align the camshaft.
- Application: BMW (N53/N54)



H.C.B-B1188 BMW (N51/N52/N52K/N53/N54) TIMING TOOLS

BMW (N51/N52/N52K/N53/N54) 正時工具組

H.C.B-I1188 BMW (N51/N52/N52K/N53/N54/N55) TIMING TOOL KIT

BMW (N51/N52/N52K/N53/N54/N55) 正時工具組



< H.C.B - I1188 >



< H.C.B - B1188 >

- Camshaft alignment fixture used to align and retain the camshafts in the TDC position.
- H.C.B-B1188 can be use on N51/ N53/ N52K/ N53/ N54
- H.C.B-G1188 can be use on N51/ N53/ N52K/ N53/ N54/ N55
- Application:
128i. E82 (07-08), 130i. E81/E87 (05-08), 135iS. E82 (07-08), 323i. E90/91/92/93 (04-08), 325i/xi. E90/91/92/93 (04-08), 328i/xi. E90/91/92/93 (04-08), 330i/xi. E90/91/92/93 (04-08), 335i/xi. E90/91/92/93 (04-08), 523i/Li. E60/E61 (04-08), 525i/Li/xi. E60/61 (04-08), 528i/Li/xi. E60/61 (06-08), 530i/Li/xi. E60/61 (05-08), 535i/xi. E60/61 (06-08), 630i. E63/64 (04-08), 730i/Li. E65/66 (04-08), X3 2.5/ 3.0. E83 (06-08), X5 3.0. E70 (06-08), Z4 2.5/3.0. E85/86 (05-08)
- Application engine:
N51/N52/N52K Valvetronic, Direct Injection, Non-Valvetronic N53/N54 and N55
- BMW OEM no. ref.: 118 520/ 114 290/ 114 280/281/ 282/285/ 110 300/ 119 340/ 110 300

H.C.B-H1188 BMW (N20/N51/N52/N52K/N52T/N55) INTERMEDIATE VALVETRONIC LEVER

BMW (N20/N51/N52/N52K/N52T/N55) 汽門彈簧拆裝器

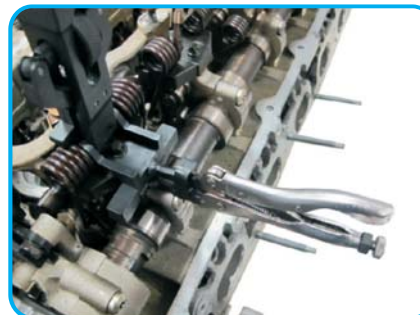

- Used for removing and installing the pressure spring for the intermediate levers on BMW (N20/ N51/ N52/ N52K/ N52T/ N55) engines.
- Fit the newer VVT spring block that is 58 mm wide.
- BMW OEM no. ref.: 117 110





010

HWANG CHERNG BIN
Specialty Tools Inc.

SINCE 1990

BMW Engine



H.C.B-A1605

BMW (N20/N47/N54/N55/N57/N63) ENGINE FUEL INJECTOR REMOVAL / INSTALLATION TOOL KIT

BMW (N20/N47/N54/N55/N57/N63) 引擎噴油嘴拆裝工具 (綜合組)

H.C.B-A1526

BMW (N55) FUEL INJECTOR REMOVAL/ INSTALLATION TOOL

BMW (N55) 噴油嘴拆裝工具

H.C.B-A1539

BMW (N20/N55) FUEL INJECTOR REMOVAL/ INSTALLATION TOOL

BMW (N20/N55) 柴油噴油嘴拆裝工具

H.C.B-A1587

BMW (N63) FUEL INJECTOR REMOVAL/ INSTALLATION TOOL

BMW (N63) 噴油嘴拆裝工具

H.C.B-A1590

BMW (N54) FUEL INJECTOR REMOVAL TOOL

BMW (N54) 噴油嘴拆卸工具

FUEL INJECTOR REMOVAL/INSTALLATION TOOL

- This tool is designed for the removal and installation of the fuel injector
- H.C.B-A1526 is used on BMW N55 (Old Model car) of engine
- H.C.B-A1539 is used on BMW N20 and new N55 engine
- H.C.B-A1539 is used on BMW N63 engine
- H.C.B-A1539 is used on BMW N54 engine
- H.C.B-A1539 is used on BMW N20/N47/N45/N55/N57/N63 engine

BMW OEM no. ref.: 130 270

BMW OEM no. ref.: 130 320

BMW OEM no. ref.: 2249115

BMW OEM no. ref.: 130 180

BMW OEM no. ref.: 13080/130270/130320/2249115

H.C.B-A1605



	Engine Model	BMW OEM no. ref.
1	N55	130 270
2	N20 / N55	130 320
3	N63	2249 115
5	N54	130 180
13	N47/N57	

H.C.B-A1590



H.C.B-A1526



H.C.B-A1539



H.C.B-A1587



H.C.B-A1556 BMW (N20/N26/N52/N55) AND MINI COOPER (N13/N16) VALVE PRESSURE SPRING REMOVER/INSTALLER

BMW (N20/N26/N52/N55) AND MINI COOPER (N13/N16) 汽門彈簧壓縮拆裝工具

- Application: BMW (N20/ N26/ N52/ N55) and MINI COOPER (N13/ N16)
- BMW OEM no. ref.: 117 110

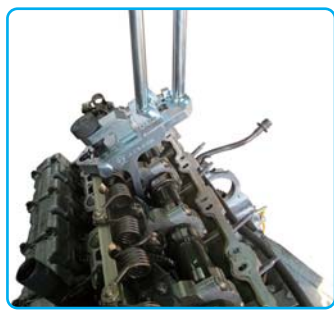

H.C.B-G1188 **ON CAR** BMW (N55) TIMING TOOL KIT

BMW (N55) 正時工具組

- This tool is used to lock the camshaft in top Dead Center (TDC) when adjusting the valve timing.
- Application: BMW N55
- BMW OEM no. ref.: 114 280/281/282/285/290 、 119 340 、 110 300

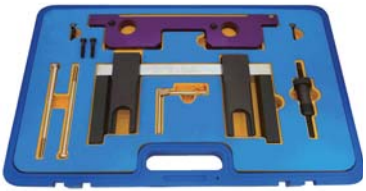

H.C.B-G1188-1 & 6 BMW (N55) CAMSHAFT GAUGE

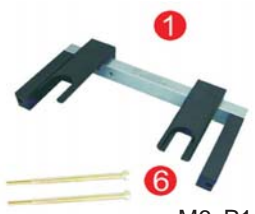

M6xP1.0x146L

BMW (N55) 凸輪軸固定座

- This tool is used to lock the to TDC when adjusting the valve timing.
- BMW OEM no. ref.: 114 281/282/285

H.C.B-G1188-2 & 5 BMW (N55) CAMSHAFT FIXING BASE



M7xP1.0x30L

BMW (N55) 凸輪軸固定座

- For disconnecting camshaft sensor gears.
- BMW OEM no. ref.: 114 281/282/285

H.C.B-G1188-3 BMW (N51/N52/N52K/N53/N54/N55) PLUG MANDREL



BMW (N51/N52/N52K/N53/N54/N55) 正時插銷

- For locking flywheel in TDC position on BMW N51, N52, N52K, N53, N54, N44
- BMW OEM no. ref.: 110 300



H.C.B-A1517

BMW (N20/N26) TIMING TOOL KIT

BMW (N20/N26) 正時工具組

Layout ID	Item no	Description	BMW OEM no. ref.:
1	A1517-1	BMW(N20/N26) CAMSHAFT LOCKING TOOL	83 30 2 212 831
2	A1517-2	BMW(N20/N26)CAMSHAFT FIXITING BASE	83 30 2 212 830
3	A1517-3	BMW(N20/N26) ALIGNMENT PIN	83 30 2 219 548
4	A1136-5	BMW (N40, N42, N45, N46, N52, N55,N62) CHAIN TENSIONER	119 340
5	A1517-5	M6 x P 1.0x L: 130mm	
6	A1517-6	M6 x P 1.0x L: 60mm	
7	A1517-7	M6 x P 1.0x L: 45mm	

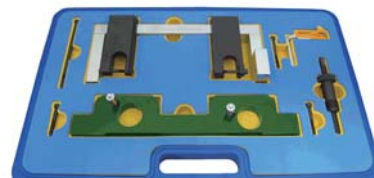

H.C.B-A1517-1&5&6

BMW (N20/N26) CAMSHAFT LOCKING TOOL

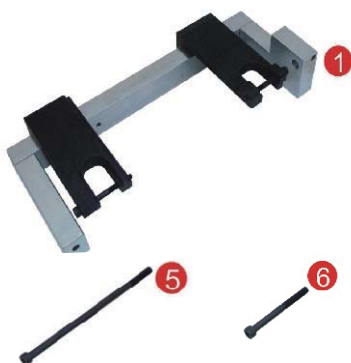

BMW (N20/N26) 凸輪軸正時工具

- This tool is used to fix the camshaft in top dead center position.
 - 1.Support bar
 - 2.Intake locking mechanism
 - 3.Exhaust locking mechanism
- **BMW OEM no. ref.:** 83 30 2 212 831



With 1st cylinder in TDC firing position, cams of exhaust camshaft point upwards at an angle.

H.C.B-A1517-2&7

BMW (N20/N26) CAMSHAFT FIXING BASE



BMW (N20/N26) 凸輪軸固定座

- This tool is used to fix the VANOS encoder wheel in top dead center position.
- **BMW OEM no. ref.:** 83 30 2 212 830

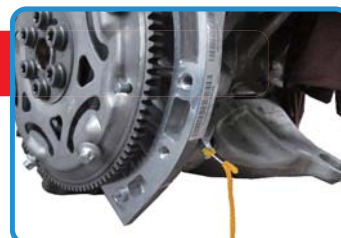

Rotate crankshaft at central bolt into TDC position. Slide in A1517-3 into dowel hole and secure crankshaft.

H.C.B-A1517-3

BMW (N20/N26) ALIGNMENT PIN



BMW(N20/N26) 正時插銷

- This alignment pin is used to fix the engine flywheel at top dead center.
- **BMW OEM no. ref.:** 83 30 2 219 548

H.C.B-E1188 BMW (N51/N52) EXHAUST CAMSHAFT UPPER AND LOWER BEARING STRIP FIXTURE REMOVAL/ INSTALLATION TOOL

BMW (N51/N52) 排氣凸輪軸上下支撐條固定拆裝器

- For removing and installing or updating the exhaust camshaft.
- Application: BMW N51/ N52
- This tool must be combined with H.C.B-A1188-1 and A1188-2

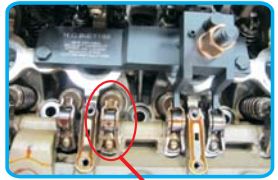

PARTS	Description	BMW OEM no. ref.:
E1188-1	Press-down tool, 2nd cylinder	114 461
E1188-2	M7 screws(2 PCS)	114 462
E1188-3	Thrust pieces (6 PCS)	114 463

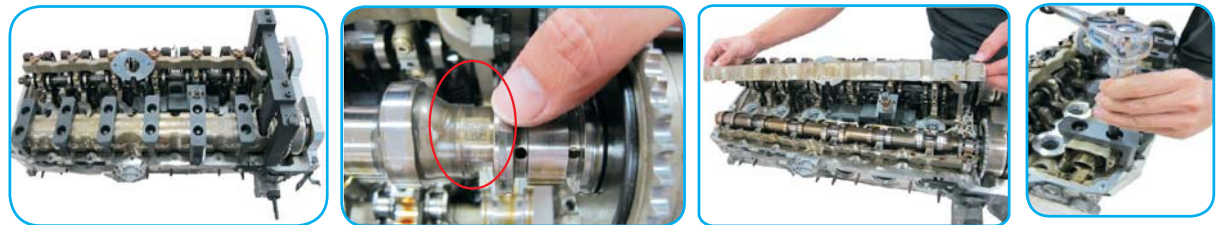

H.C.B-A1550 BMW (N54/N54T) EXHAUST CAMSHAFT REMOVAL /INSTALLATION TOOL

BMW (N54/N54T) 排氣凸輪軸上下支撐條固定拆裝器

- For holding the bearing strips in place when fitting intake camshaft.
- H.C.B-E1188 is used on BMW (N51/N52); **BMW OEM no. ref.:** 1114 461/ 462/ 463
- H.C.B-A1550 is used on BMW (N54/N54T); **BMW OEM no. ref.:** 118 550/ 551



H.C.B-A1657 **NEW** BMW (N55) EXHAUST CAMSHAFT TENSION TOOL

BMW (N55) 排氣凸輪軸固定工具

- This tool is used to press down the exhaust camshaft for a tension-free removal and installation.
- This tool must be combined with H.C.B-E1188.
- Application: N55
- **BMW OEM no. ref.:** 117 100 (83 30 0 496 672)





H.C.B-F1188

BMW (N51/N52) VACUUM PUMP SEALING CAP REMOVAL/ INSTALLATION TOOL

BMW (N51/N52) 真空泵密封蓋拆裝器

- For removing and installing vacuum pump sealing cap.
- Application: BMW N51/N52
- **BMW OEM no. ref.:** 114360/110290



H.C.B-A1553

BMW (N20/N26/N55) FIXING TOOL

BMW (N20/N26/N55) 固定工具

- Application: BMW N20/N26/N55
- **BMW OEM no. ref.:** 114 450



H.C.B-A1438

BMW (N40/N42/N45/N45T/N46/N46T/N52/N53/N54) CRANKSHAFT FRONT/REAR OIL SEAL REMOVAL / INSTALLATION TOOL KIT

BMW (N40/N42/N45/N45T/N46/N46T/N52/N53/N54)
曲軸前後油封拆裝工具組

- Combine H.C.B-A1394 and H.C.B-C1188 as a master kit.
- For removing and installing the front and rear crankshaft seal.
- Application: N40/N42/N45/N45T/N46/N46T/N52/N53/N54



H.C.B-C1188

BMW (N40/N42/N45/N45T/N46/N46T/N52/N53/N54) CRANKSHAFT REAR OIL SEAL REMOVAL / INSTALLATION TOOL KIT

BMW (N40/N42/N45/N45T/N46/N46T/N52/N53/N54)
曲軸後油封拆裝工具組

- For removing and installing the rear oil seal on crankshaft
- Application: BMW (N40/N42/N45/N45T/N46/N46T/N52/N53/N54)



Extraction



Installation Step1



Installation Step2



H.C.B-C1188-1



H.C.B-C1188-2-1



H.C.B-C1188-2-3



H.C.B-C1188-2-2



M12xP1.5



H.C.B-C1188-2-4

H.C.B-A1394 BMW (N40/N42/N45/N45T/N46/N46T/N52/N52K/N53/N54) CRANKSHAFT FRONT OIL SEAL REMOVAL / INSTALLATION TOOL KIT

BMW (N40/N42/N45/N45T/N46/N46T/N52/N52K/N53/N54) 曲軸前油封拆裝工具組

H.C.B-C1394 BMW (N40/N42/N45/N45T/N46/N46T/N52/N52K/N53/N54/N55) CRANKSHAFT FRONT OIL SEAL REMOVAL / INSTALLATION TOOL KIT

BMW (N40/N42/N45/N45T/N46/N46T/N52/N52K/N53/N54/N55) 曲軸前油封拆裝工具組

BMW CRANKSHAFT FRONT OIL SEAL REMOVAL / INSTALLATION

- For removing and installing the front crankshaft seal.
- Application: BMW N40/ N42/ N45T/ N46/ N46T/ N52/ N53/ N54
- **BMW OEM no. ref.:** 119 220/ 116 230



REMOVAL



INSTALLATION



< H.C.B-A1394 >

- Used to loosen the seal for removal and installation of new front crankshaft seals.
- **BMW OEM no. ref.:** 110 370, 119 220, 119 230



< H.C.B - C1394 >

H.C.B-B1394 BMW (N55) CRANKSHAFT FRONT OIL SEAL REMOVAL / INSTALLATION TOOL KIT

BMW (N55) 曲軸前油封拆裝工具組

- For removing and installing the front crankshaft seal.
- Application: BMW N55
- **BMW OEM no. ref.:** BMW 119 220/ 119 230/ 119 235

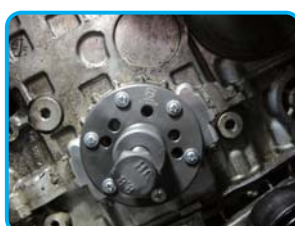

REMOVAL



REMOVAL

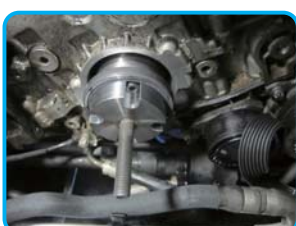

INSTALLATION

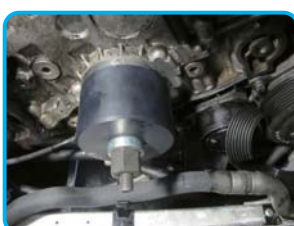

INSTALLATION



H.C.B-A1437

BMW (M47/M47TU/S65/S85) OIL SEAL PULLER

BMW (M47/M47TU/S65/S85) 正時齒輪油封拆卸器

- To pull out the shaft sealing ring from the timing gear box cover.
- Application: BMW M47/M47TU/S65/S85
- BMW OEM no. ref.: 116 360/361



H.C.B-A1464

BMW (M47T2/M47TU/M57/M57D25/M57D30/M57T2/M57TU/M70/M73/S85) OIL SEAL PULLER

BMW (M47T2/M47TU/M57/M57D25/M57D30/M57T2/M57TU/M70/M73/S85) 正時齒輪油封拆卸器

- Apply to shaft sealing ring of the timing gear box cover.
- Application: BMW M47T2/ M47TU/ M57/ M57D25/ M57D30/ M57T2/ M57TU/ M70/ M73/ S85
- BMW OEM no. ref.: BMW 111 210



H.C.B-A1534

BMW (N54) FRONT ENGINE SEAL REMOVER

BMW (N54) 前引擎油封拆卸器

- Used to remove the front lower engine seal.
- BMW OEM no. ref.: 110 370/ 371

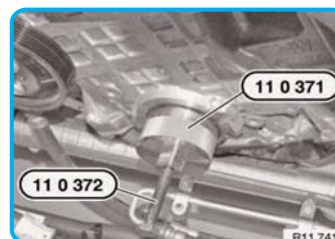

H.C.B-A1392

BMW (N40/N45/N45T) PETROL ENGINE TWIN CAMSHAFT SETTING / LOCKING TOOL KIT

BMW (N40/N45/N45T) 正時工具組

- Suitable for timing 1.6 Litre BMW N40, N45 and N45T chain driven petrol engines with Vanos units on the inlet and exhaust camshafts.
- Engine Codes: N40, N45, N45T (B16)
- Application:
BMW 116 1.6 i E81/E87 (03-09)
316 1.6 i E46/E90 (01-08)
316 1.6 Ci E46 (01-06)
316 1.6 ti E46 (01-05)





010
HWANG CHERNG BIN
Specialty Tools Inc.

BMW引擎修護工具
BMW Engine Repair Tool

H.C.B-S85

BMW (S85) CAMSHAFT ALIGNMENT TOOL KIT (E60/M5, E63/M6)

BMW (S85) 凸輪軸正時工具組 (E60/M5,E63/M6)

4 / 19.5 / 20.5 / 3.28'



- Include : HCB-A1250,B1250,C1250,D1250,E1250

H.C.B-A1250

BMW (S85) CAMSHAFT TIMING TOOL

BMW (S85) 凸輪軸正時工具

- This tool is for fixing the camshaft at the TDC position and used for dismatling and assembling intake and exhaust camshaft.
- Application: BMW engine models S85
- **BMW OEM no. ref.:** 115 300

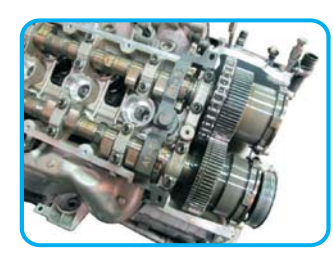

H.C.B-B1250

BMW (S85) TIMING PIN

BMW (S85) 正時插銷

- Lock the crankshaft at the the TDC position.
- Application: S85
- **BMW OEM no. ref.:** 115 320



H.C.B-C1250

BMW (S85) VANOS CAMSHAFT GAUGE

BMW (S85) 量規

- Used for locking the camshaft at the TDC position
- **BMW OEM no. ref.:** 118 380

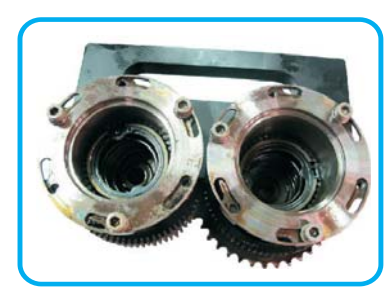



H.C.B-D1250

BMW (S85) VANOS CAMSHAFT GAUGE

BMW (S85) 量規

- Adjusting plate for setting valve timing on engine with double VANOS.
- BMW OEM no. ref.: 115 410

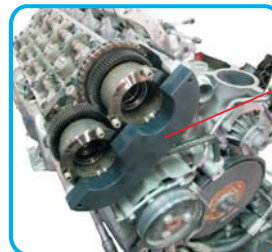

D1250

H.C.B-E1250

BMW (S85) VANOS TIMING SOCKET

BMW (S85) VANOS 凸輪軸套筒

- For adjusting VANOS during assembly as well as for adjusting valve timing.
- Application: S52B30, S50B32, S54, S85.
- BMW OEM no. ref.: 115 100

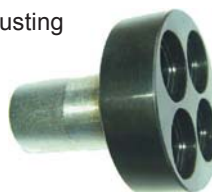

E1250



H.C.B-A1198

MINI COOPER (R53) VIBRATION DAMPER TOOL

MINI COOPER (R53) 曲軸支撐拔卸器

6 / 20.2 / 22 / 2.65'



- Genuine stock no.: BMW 1123 7525135
- Application: MINI COOPER engine-driven supercharging (R53)

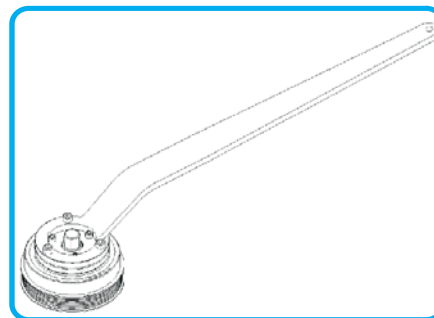

Step1: Use H.C.B-A1198-1, -2&-6 to hold pulley, and release the central bolt.

Step2: Tighten the part #3 and screw #5 then extract the pulley by wrench.

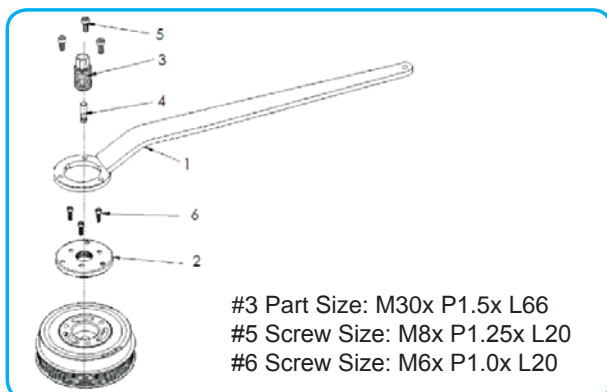

#3 Part Size: M30x P1.5x L66
#5 Screw Size: M8x P1.25x L20
#6 Screw Size: M6x P1.0x L20

H.C.B-B1198 MINI COOPER (W11) CRANKSHAFT PULLEY PULLER

MINI COOPER (W11) 曲軸皮帶盤拔取工具組

- Use this tool to extract vibration damper.
- Combined with H.C.B-A1198 and H.C.B-C1198. Combined with H.C.B-A1198 and H.C.B-C1198.
- Application: MINI COOPER (W11)
- BMW OEM no. ref.: 11 8 450



ITEM NO.	SPECIFICATION
B1198-1	Main Body
B1198-2	M12xP1.0xL120
B1198-3	M6xP1.0xL65

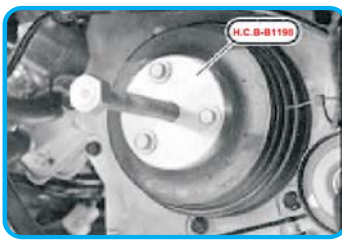

H.C.B-C1198 MINI COOPER (W11) CENTRAL HOLDING BOLT

MINI COOPER (W11) 中心支撐螺絲

- Put this tool in the crankshaft when repairing.
- Combined with H.C.B-A1198 and H.C.B-B1198.
- Application: MINI COOPER (W11)
- BMW OEM no. ref.: 11 8 270



M12xP1.75

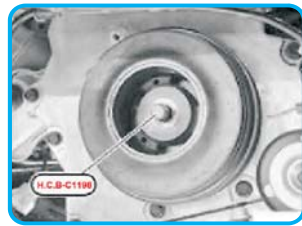

H.C.B-D1198 MINI COOPER (R53/W11) CRANKSHAFT PULLEY PULLER

MINI COOPER (R53/W11) 曲軸皮帶盤拔取器

Item No.	Name	Specification	Quantity
D1198-1	Main body		1
D1198-2	Central bolt	M12 x P1.0	1
D1198-3	Bolt	M8 x P1.25	3
D1198-4	Washer	M8	3
D1198-5	Bolt	M6 x P1.0	3
D1198-6	Washer	M6	3

- To extract crankshaft pulley, use D1198.
- Application: MINI COOPER R53 / W11

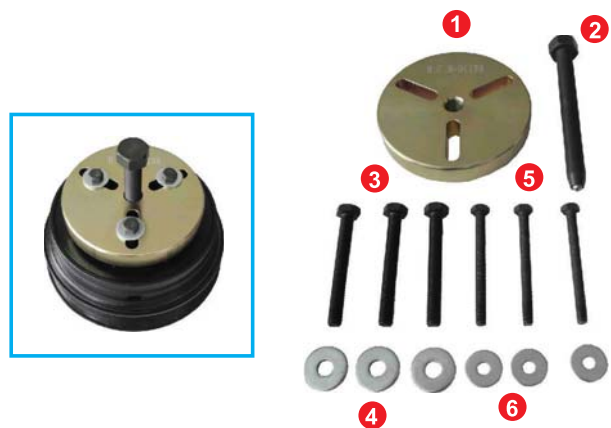

Genuine no.: 1123 7525135



H.C.B-E1198

MINI COOPER (R53/W11) CRANKSHAFT PULLEY INSTALLER

MINI COOPER (R53/W11) 曲軸皮帶盤安裝器

Item No.	Name	Specification
E1198-1	Bearing base	
E1198-2	Bolt	M12 x P1.75
E1198-3	Nut	H19 x M12 x P1.75

- To install crankshaft pulley, use E1198.
- Application: MINI COOPER R53 / W11



Genuine no.: 1123 7525135

H.C.B-A1408

BMW (M47T2/M47TU/M57T2/M57TU) V-BELT INSTALLER

BMW (M47T2/M47TU/M57T2/M57TU) V 型皮帶安裝工具

- For installing the V-belt without causing damage.
- Application: BMW M47T2/M47TU/M57T2/M57TU
- Model :
2009 - 2011 BMW - 335d
2011 - 2013 BMW - X5 35d, xDrive
2009 - 2010 BMW - X5 35d
- BMW OEM no. ref. : 110 330

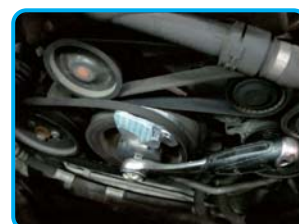

H.C.B-A1540

BMW (N47/N57) VIBRATOR DAMPER LOCKING REMOVAL / INSTALLATION TOOL KIT

BMW (N47/N57) 曲軸支撐拆裝工具組

- This tool is designed for removing and installing vibrator damper.
- Application: BMW N47/ N57
- BMW OEM no. ref.: 117 221/ 222/ 223 and 116 480



H.C.B-A1542 BMW (E39/E46/E60/E61/E81/E83/E90/E91) CRANKSHAFT HARMONIC BALANCER PULLEY HOLDER

BMW (E39/E46/E60/E61/E81/E83/E90/E91) 曲軸支撐扳手

H.C.B-B1542 BMW (E39/E46/E60/E61/E81/E83/E90/E91) CRANKSHAFT HARMONIC BALANCER PULLEY HOLDER (1/2")

BMW (E39/E46/E60/E61/E81/E83/E90/E91) 曲軸支撐扳手 (1/2")

BMW CRANKSHAFT HARMONIC BALANCER PULLER HOLDER



<H.C.B-A1542>

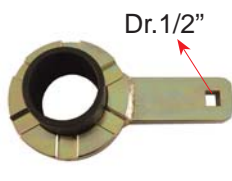

<H.C.B-B1542>



- Hold vibration damper when loosening and tightening center crankshaft bolt.
- Application:
 - BMW E81 120d 163PS
 - BMW E46 318d 116PS - 318td 115PS - 318dt 115PS - 318d 115PS - 320d 136PS - 320td 150PS - 320d 150PS
 - BMW E90 318d 150PS - 320d 150PS - 320d 163PS
 - BMW E91 318d 122PS - 320d 150PS - 320d 163PS
 - BMW E39 520d 136PS
 - BMW E60 520d 163PS - 520d 150PS
 - BMW E61 520d 150PS - 520d 163PS
 - BMW X3 E83 2.0d 150PS

H.C.B-A1262 BMW (M47/M57) DIESEL ENGINE CAMSHAFT ALIGNMENT TOOL

BMW (M47/M57) 柴油引擎正時工具組

20 / 24.2 / 25.2 / 1.9'

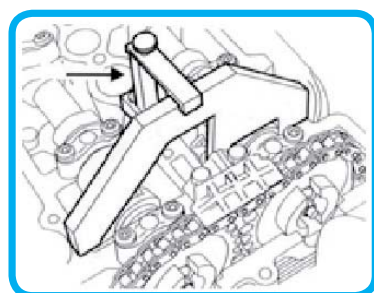

- Camshaft setting and flywheel locking tools covering the latest range of BMW 2.0 and 3.0 litre common rail diesel engines used in BMW and other manufacture's models.
- Application: BMW 2.0 (M47) and 3.0 (M57) Diesel Engines in BMW 3, 5 & 7 Series, X5, Land Rover Free lander, Range Rover, Rover 75
- BMW OEM no. ref. : 116320,112300,116320,113340.



H.C.B-B1262

BMW (M41/M51/M47TU/M47T2/M57TU/M57T2) DIESEL TIMING TOOL KIT

BMW (M41/M51/M47TU/M47T2/M57TU/M57T2) 柴油引擎正時工具組

5 / 19.6 / 20.6 / 1.5'

- For installing and removing camshaft/ variable camshaft timing unit.
- For checking and adjustment of timing.
- Application: M41, M51, M47 - M47 TU/T2, M57 TU/T2 2.0L / 3.0L 1998 later
- **BMW OEM no. ref.:** 116 080, 115 180, 135 192, 113 360, 135 190, 135 191, 135 120, 113 320, 112 300, 116 322, 113 340

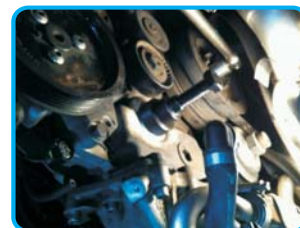

H.C.B-C1262

BMW DIESEL 2.5TDS TENSIONER LEVER

BMW 柴油 2.5TDS 正時鏈條壓縮器

- To remove camshaft chain tensioner on BMW 2.5tds engines.
- This tool is positioned inside the cam timing chain cover and levered against the chain bow to press in the chain tensioner.
- Application:
BMW M41/M51 Diesel Engines fitted in
BMW 318tds, 325, 525, 725td/tds,
Land Rover Range Rover 2.5DT/SE (After 94),
Vauxhall/Opel Omega-B 2.5TD
- **BMW OEM no. ref.:** 113360.



H.C.B-C1421

BMW (2.0 N47/ 3.0 N57) DIESEL ENGINE TIMING TOOL

BMW (2.0 N57/3.0 N57) 柴油引擎正時工具

Parts No.	Description	BMW OEM no. ref.
A1421-1	Flywheel plate timing pin	115 320
A1421-2	Camshaft alignment tool	118 760
A1421-3	Crankshaft pulley turning tool	116 480
A1421-4-1	Remover socket	118 741
A1421-4-2	Hex unit	118 742
A1421-5	Tensioner locking pins x 2	113 340
B1421	Crankshaft locking tool	114 320



- Include camshaft setting plate, flywheel locking pin and crankshaft turning tool.
- Also include HP pump sprocket retaining tool required during pump removal and replacement applications.

H.C.B-B1421 BMW (2.0 N47/3.0 N57) DIESEL ENGINE CRANKSHAFT LOCKING TOOL

BMW (2.0 N47/3.0 N57) 柴油引擎曲軸固定工具

- This kit is necessary when the timing chain creaks (links damaged). The N47 engine family is prone to excessive timing chain wear and premature failure.
- Rattling noise from rear of the engine is indicative of the condition.
- Timing chain failure may call for engine replacement or a costly repair.
- The issue applies to all applications and power variants, from 2007 up to 2011 models.
- Without it, it's IMPOSSIBLE to replace:
The oil pump chain, both timing chains, the gear of the high pressure pump and of the balancer shaft.



Without this tool the engine works irregularly.

- Application:
BMW: 114d, 116d, 118d, 120d, 120d/xDrive, 123d, 125d, 316d, 318d, 320d, 320d/EfficientDynamics, 320d/xDrive, 325d, 330d, 520d, 520d/EfficientDynamics, 520d/xDrive, 525d, 530d, 530d/xDrive, 530d/xDrive GT, 535d, 535d/xDrive, 535d/xDrive GT, 640d/xDrive, 730d, 730d/xDrive, M550d/xDrive, X1
- Engine: 1.6D, 2.0D, 3.0D
- Engine codes
N47D20A, N47D20A/0U0, N47D20A/O0, N47D20C, N47D20C/01, N47D20C/K1, N47D20C/O1, N47D20C/U1, N47D20D/T1, N47D20O0, N47D20O1, N47D20U0, N47SD20B/D/T0, N47SD20D/T0, N47TD20K1, N47TD20O1, N47TD20U1, N57D30A/O0, N57D30A, N57D30B/T0, N57D30C/S1, N57D30A/O0, N57D30B/T0, N57D30O0, N57D30O1, N57D30C/S1, N57D30T0, N57D30U0, N57D30UO, N57D30TO, N47D16
- BMW OEM no. ref.: 11 4 320



H.C.B-A1421 BMW (N47/N47S) DIESEL ENGINE TIMING TOOL KIT

BMW (N47/N47S) 柴油引擎正時工具組

- For timing the BMW N47/N47S 2.0 twin camshaft diesel chain drive engines, fitted in the 1 Series, 3 Series, 5 Series and X3.
- Application: BMW 1 Series, 118d (E81/E87)(06-09), 120d (E81/E82/E87)(06-09), 123d (E81/E82/E87)(07-09). 3 Series, 318d (E90/E91)(07-09), 320d (E90/E91/E92)(05-09). 5 Series, 520d (E60/E61)(06-08). X3, 2.0d (E83)(07-09)
- Engine Codes: N47, N47S(2007-2010)

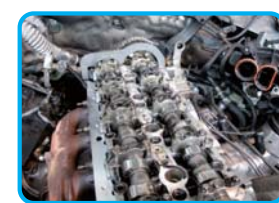
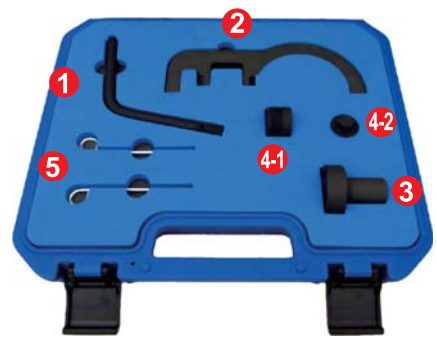

Parts No.	Description	BMW OEM no. ref.
A1421-1	Flywheel plate timing pin	115 320
A1421-2	Camshaft alignment tool	118 760
A1421-3	Crankshaft pulley turning tool	116 480
A1421-4-1	Remover socket	118 741
A1421-4-2	Hex unit	118 742
A1421-5	Tensioner locking pins x 2	113 340



H.C.B-C1300

MINI COOPER (N12/N14/N16) TIMING TOOL KIT

MINI COOPER (N12/N14/N16) 正時工具組

- Combine A1300 and B1300 as a master kit.
- Position crankshaft by H.C.B-A1300-4 when rotating crankshaft in central bolt.
- Note: Do not remove H.C.B-A1300-4 while maintenance.
- When repairing exhausted camshaft, install H.C.B-A1300-1 on it and fix it by H.C.B-A1300-3.
- Install H.C.B-A1300-2 to cylinder head cover, then fastened by H.C.B-A1300-3-1. Put H.C.B-A1300-1 on intake camshaft, and fixed tool by H.C.B-A1300-3.
- Application:
MINI COOPER (N12/N14) 2007 R55
MINI COOPER (N12/N14) 2006~2007 R56

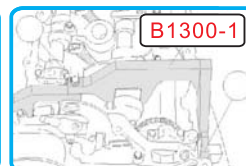
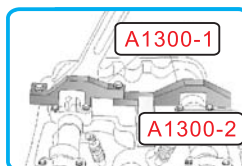

H.C.B-A1300

MINI COOPER (N14) TIMING TOOL KIT

MINI COOPER (N14) 正時工具組

- Position crankshaft by H.C.B-A1300-4, when rotating crankshaft in central bolt.
- Note: Do not remove H.C.B-A1300-4 while maintenance.
- When repairing exhausted camshaft, installed H.C.B-A1300-1 on it and fixed tool by H.C.B-A1300-3.
- Installed H.C.B-A1300-2 to cylinder head cover then fasten by H.C.B-A1300-3-1. Put H.C.B-A1300-1 on intake camshaft, and fix it by H.C.B-A1300-3.
- Application:
MINI COOPER (N14) 2007 R55
MINI COOPER (N14) 2006~2007 R56

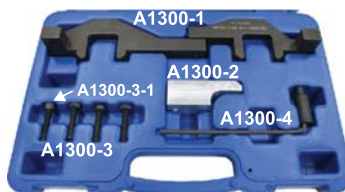

H.C.B-B1300

MINI COOPER (N12) TIMING TOOL KIT

MINI COOPER (N12) 正時工具組

- Application:
MINI COOPER (N12)
2007 R55
MINI COOPER (N12)
2006~2007 R56

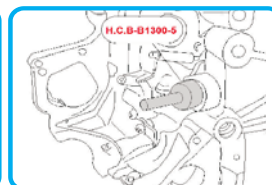
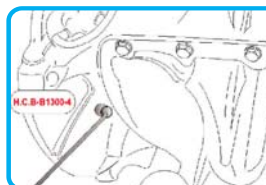
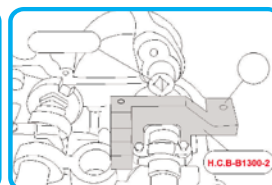

H.C.B-A1518 BMW (N13/N18) TIMING TOOL KIT

BMW (N13/N18) 正時工具組

- To lock camshafts in 90 degree piston position.
- Application:
2011+ R56 Cooper S Hatchback
2011+ R55 Cooper S CLUBMAN
2011+ R57 Cooper S Convertible
2010/11 R60 Cooper S Countryman
- **BMW OEM no. ref.:** 117 440, 119 340
119 590, 496 709.



H.C.B-B2105 BMW CYLINDER HEAD BOLT REMOVAL AND INSTALLATION TOOL (Dr. 1/2", LENGTH: 200 mm, T40/T45/T50/T55/T60/T70)

BMW 汽缸頭螺絲拆裝工具組 (Dr. 1/2", 長度 : 200 mm, T40/T45/T50/T55/T60/T70)

Parts No.	Size	Dr.	Length(mm)	Applications.
B2105-2040	T40	1/2	200	
B2105-2045	T45	1/2	200	Ford 1.6, 1.8, 2.4, 2.8 and Volkswagen Passat
B2105-2050	T50	1/2	200	BMW E34 3.0 liter V8 engines and M60/M70/N73/N52 non-Turbo and N54/N55 Turbo engines.; Also is used in conjunction with the Alternator nut for the Alternator pulleys on various Mercedes models.
B2105-2055	T55	1/2	200	2.4L New World Engine in 2007 Dodge Caliber, Opel, Ford, Mondeo ,Renault; Mercedes, Vauxhall on V6 OHC engines /
B2105-2060	T60	1/2	200	Ford/Ford Focus 1.8 Di, BMW N52 non-Turbo and N54/N55 Turbo engines
B2105-2070	T70	1/2	200	Nissan, Toyota, Mazda, Ford/ Ford 1.8 Diesel, Turbo



H.C.B-A1224 MINI COOPER (R50 /R53) CAMSHAFT PULLEY TOOL KIT

MINI COOPER (R50/R53) 皮帶盤工具組

10 / 9.3 / 12.8 / 0.56'

- Use A1224-1 to loosen the camshaft pulley, and use A1224-2 to lock the camshaft pulley tensioner, at the same time, then remove the parts under the oil pan and the pulley.
- Application: Mini Cooper (R50/R53), engine W10/W11.
Cooper (W10) -- Year: 2001-2007
Mini one (W10) -- Year: 2001-2007

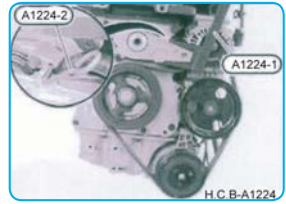

H.C.B-A1288 MINI COOPER (S/W11) SERPENTINE BELT TOOL

MINI COOPER (S/W11) 皮帶拆裝工具

10 / 13.4 / 16.8 / 1.75'

- Used to hold the serpentin belt tensioner on the supersharged MINI W11 engine.
- Application: Mini Coopers S / W11 Engine.
Cooper (W11) - Year 2001-2007





010
HWANG CHERNG BIN
Specialty Tools Inc.

SINCE 1990

BMW Engine



H.C.B-A1523

MINI COOPER (N12/N14/N16/N18) SERPENTINE BELT TOOL

MINI COOPER (N12/N14/N16/N18) 皮帶拆裝工具

- Each set comes with a one large and one small 12 point wrench. If needed, you can use 1/2" drive ratchet to help with indexing the wrench onto the tensioner and for compressing the tensioner back.
- Application: All 2007 and newer Mini Cooper N12, N14, N16 and N18 engines.
- BMW OEM no. ref.:** 116 210.
(ONLY SOLD AS A PAIR)
There is NO way to determine which tensioner came equipped on the vehicle without physically inspecting the car to see if you need the large or small wrench.



H.C.B-A1309

MINI COOPER (W10/W11) TIMING TOOL KIT

MINI COOPER (W10/W11) 正時工具組

- Application:
MINI COOPER (W10/W11)
(W10) 2001~2007 R50,
(W10) 2003~2007 R52,
(W11) 2003~2007 R52,
- BMW OEM no. ref.:** 118 370, 118 250, 118 240



H.C.B-A1317

MINI COOPER (N14) DOWN-PRESSED CAMSHAFT FIXED BASE

MINI COOPER (N14) 下壓式凸輪軸固定器

- This tool prevents camshaft from coming off.
- Put A1317-1 into sparking plugs by A1317-2. Rotating along the arrow and tighten camshaft.
- Loosen all the bolts in the bearing covers.
- Application: Mini Cooper N14.

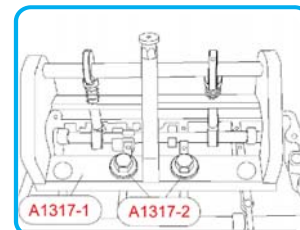
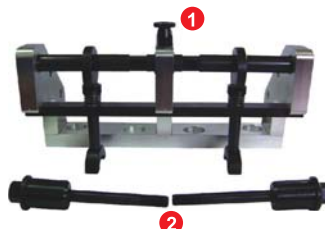

H.C.B-B1317

BMW (N14/M50/M52/S50) CAMSHAFT REMOVING FIXTURE

BMW (N14/M50/M52/S50) 凸輪軸固定座

- This tool is used to hold the camshaft journals in place during camshaft removal.
- Application: BMW (N14/ M50/ M52/ S50)
- BMW OEM no. ref.:** 113 270



H.C.B-A1292

BMW (N40/N42/N45/N46) BALANCE SHAFT LOCK PLATE - OLD STYLE

BMW (N40/N42/N45/N46) 平衡軸正時工具 (舊型)

- Aligning the balance shaft in the TDC position during assembly and disassembly.
- Application: BMW N40, N42, N45, N46 engine.
- BMW OEM no. ref.:** 119 330.



H.C.B-B1292

BMW (N45/N46/N46T) BALANCE SHAFT LOCK PLATE - NEW STYLE

BMW (N45/N46/N46T) 平衡軸正時工具 (新型)

- Aligning the balance shaft in the TDC position during assembly and disassembly.
- Application: BMW N45, N46, N46T engine.
- BMW OEM no. ref.:** 115 140.

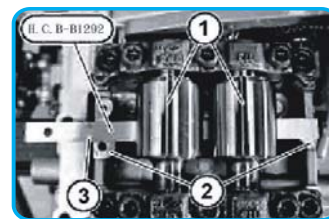

H.C.B-A1302

BMW (N12/N14/N16/N18/N40/N42/N45/N46/N52) CRANKSHAFT HUB LOCKING TOOL

BMW (N12/N14/N16/N18/N40/N42/N45/N46/N52) 曲軸支撐扳手

- Fixed crankshaft pulley when releasing / tightening central bolt.
- Application: BMW N12 / N14 / N40 / N42 / N45 / N46 / N52
- BMW OEM no. ref.:** 119 280



H.C.B-A1311

BMW (M20/M40/M41/M43/M44/M50/M51/M52) CRANKSHAFT HUB LOCKING TOOL

BMW (M20/M40/M41/M43/M44/M50/M51/ M52) 曲軸支撐扳手

- To hold front damper for removing.
- Application: M20, M40, M41, M43, M44, M50, M51, M52.



H.C.B-B1311

BMW (M41/M43/M43TU/M44/M50/M52/M52TU/S52US) SPACER RING

BMW (M41/M43/M43TU/M44/M50/M52/M52TU/S52US) 間格墊圈

- For holder to lock crankshaft in position when releasing and tightening central bolt.
- Application: M41, M43, M43TU, M44, M50, M52, M52TU, S52US
- Combined with H.C.B-A1311
- BMW OEM no. ref.:** 112 410





H.C.B-A1316

BMW (N43) TIMING TOOL KIT

BMW (N43) 正時工具組

4 / 20 / 21.2 / 3.28"

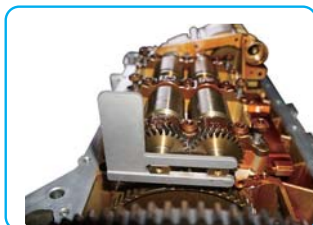

- Used to check, adjust and see the camshaft timing.
- **BMW OEM no. ref.:** 118 690,118 710,118 700,115 120,113 340, 119 340.

■ Applicable:		
Chassis No.	Model	Type
E87	118i, 120i	Hatch Back
E90	316i, 318i	Sedan
E91	320i	Station Wagon
E92	320i	Coupe
E93	320i	Convertible
E60	520i	Sedan
E61	520i	Station Wagon

H.C.B-A1477

BMW (S54/M3) CAMSHAFT ALIGNMENT TOOL

BMW (S54/M3) 凸輪軸正時工具

Parts No.	Description	OEM NO.
A1477-1	Camshaft Timing Gauge For checking camshaft timing when installing VANOS adjustment unit on S54 Motorsport Engines	119 140
A1477-2	Camshaft Lead Angle Gauge For setting camshaft lead angle(1.5 degree) (Control diagram)when installing VANOS adjustment unit on S50B32.Liter and S54 Motorsport Engines. Note: Replaced by #119 140 & #117342	119 130
A1477-3	PIN	117 340 /342
A1477-4	VANOS spacer Used to set up the VANOS unit.	119 170
A1477-5	VANOS spanner wrench	117 160
A1477-6	Adapter with wrench Used to turn engine at crankshaft when adjusting valve timing.	115 100
A1477-7	Arbor This tool is used for locking the flywheel in position (TDC mark).	112 300

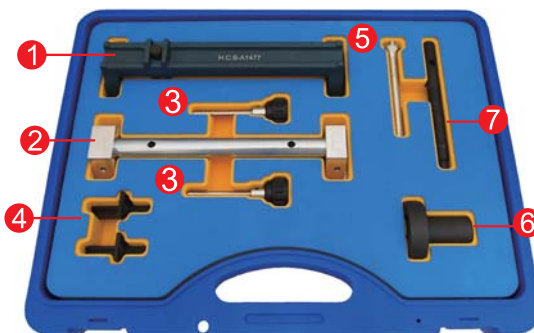

- Application:
M3 (S54) Cabriolet Year 2000-2006
M3 (S54) Sports Coupe Year 1999-2006
M3 CSL (S54) Sports Coupe Year 2003-2004
- **BMW OEM no. ref.:** 119 140,119 130,117 340/342, 117 160,115 100,112 300,119 170.

H.C.B-A1340

BMW (M47T2/M47TU/M57T2/M57TU/M67/N45/N45T/N46/N46T/N51/N52/N53/N54/N55/W17) FLYWHEEL HOLDER

BMW (M47T2/M47TU/M57T2/M57TU/M67/N45/N45T/N46/N46T/N51/N52/N53/N54/N55/W17) 飛輪固定器

- When replacing timing chain, this tool can hold flywheel. It helps to release and tighten down central bolts on vibration damper.

- Application: BMW M47T2/M47TU/M57T2/M57TU/M67/N45/ N45T/N46/N46T/N51/ N52/N53/N54/W17.

- **BMW OEM no. ref.:** 118 180,118 182,118 183,118 184,118 185.

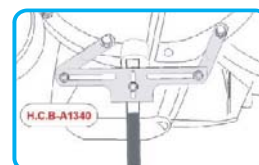

H.C.B-A1528

BMW (S65) TIMING TOOL KIT

BMW (S65) 正時工具組

- This tool is used to align and fix the camshaft at Top Dead Center (TDC) during assembly. Used to hold the crankshaft at Top Dead Center (TDC) when adjusting the camshaft timing.
- Application: BMW S65
- **BMW OEM no. ref.:**
115 370,119 971,119 972,
115 320,115 290.



H.C.B-A1597

BMW/ MINI AND PSA GROUP PETROL ENGINE TIMING CHAIN SERVICE TOOL KIT

BMW/ MINI AND PSA GROUP 汽油引擎鏈條正時工具組

- Applications:
BMW: 116i E81/82/87/88 (04-09), 118i E81/82/87/88 (04-12), 120i E81/82/87/88 (04-12), 125i E82 (07-12), 130i E81/87 (05-12), 135iS E82 (07-12), 316i/ti Compact E46 (01-07), 316i E90/91/92/93 (05-10), 318i/ti Compact E46 (01-07), 318i E90/91/92/93 (05-12), 320i E90/91/92/93 (05-12), 323i E90/91/92/93 (04-11), 325i E90/91/92/93 (04-12), 330i E90/91/92/93 (04-12), 335i E90/91/92/93 (04-12), 520i E60/61 (07-10), 523i E60/61 (04-10), 525i E60/61 (04-10), 530i E60/61 (05-10), 630i E63/64 (04-11), 730i E65/66 (04-08), Z4 2.0 E85/86 (04-09), Z4 2.5/3.0 E85/86 (05-09), X1 sDrive 18i E84 (10-12), X1 xDrive 18i E84 (10-12), X3 2.0 E83 (05-10), X3 2.5/3.0 E83 (06-10), X5 3.0 E70 (06-10),
Mini: Cooper S R55/56 (06-10), Cooper R55/56 (06-10), Mini One R56 (07-10),
Citroen: C4 Picasso (08-11), C4 (08-11), C3, C3 Picasso
Peugeot: 207 (06-11), 207CC (07-11), 308 (07-11),3008,5008
- **BMW OEM no. ref.:** 11 4 360, 11 5 140, 11 9 280, 11 9 330



H.C.B-A1301

BMW (N62/W17) AIR CONDITIONING COMPRESSION BELT INSTALLER

BMW (N62/W17) 冷氣壓縮機皮帶安裝器

- To fasten the belt when installing the belt.
- Application: BMW (N62/W17)





H.C.B-B1301

BMW (N62/W17) AIR CONDITIONING COMPRESSION BELT INSTALLER

BMW (N62/W17) 冷氣壓縮機皮帶安裝器

- Fasten the belt when installing the belt.
- Application: BMW (N62/W17)
- **BMW OEM no. ref.:** 641040



H.C.B-A1567

BMW (N52K) V-BELT INSTALLER

BMW (N52K) V 型皮帶安裝工具

- Special design for installing the V-belt without causing damage.
- Application: BMW N52K engine (2006~2010)
- **BMW OEM no. ref.:** 111 240

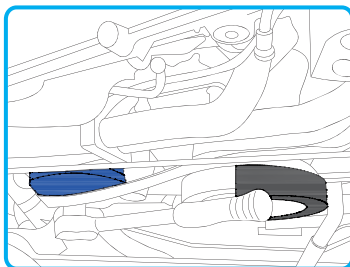

H.C.B-A1385

BMW (F01/F02/F25/X3) FUEL TANK LID WRENCH

BMW (F01/F02/F25/X3) 油箱蓋拆裝器

- This tool is used for removing and installing the metal fuel tank lid.
- Application: BMW (F01/F02/F25)

Model	Chassis Series	Engine	Year
740i	F01	N54	2011, 2012
750i	F01	N63	2009, 2010, 2011, 2012
750i xDrive Sedan	F01	N63	2010, 2011, 2012
BMW ALPINA B7	F01	N63	2011, 2012
BMW ALPINA B7 xDrive	F01	N63	2011, 2012
740Li	F02	N54	2011, 2012
750Li	F02	N63	2009, 2010, 2011, 2012
750Li xDrive Sedan	F02	N63	2010, 2011, 2012
760Li Sedan	F02	N74	2010, 2011
BMW ALPINA B7 LWB	F02	N63	2011, 2012
BMW ALPINA B7 xDrive LWB	F02	N63	2011, 2012
X3 xDrive28i A	F25	N52T	2011, 2012
X3 xDrive35i A	F25	N55	2011, 2012



H.C.B-A1366 BMW (N47) HIGH PRESSURE PUMP REMOVER

BMW (N47) 高壓泵拆卸組

- To remove the high pressure pump.
- Application: BMW N47
- BMW OEM no. ref.: 118740



H.C.B-A1401 BMW FUEL LEVEL SENSOR LOCK RING REMOVER

BMW 汽油幫浦感應器拆卸工具

- Used to remove the fuel level lock ring.
- Applications:
BMW and Mini Cooper Models: 1988-2011
E31, E34, E36, E38, E39, E46, E53, E60, E63, E64, E65, E70, E83, E85, E90, R50,
R52, R53, R55, R56 and R57.

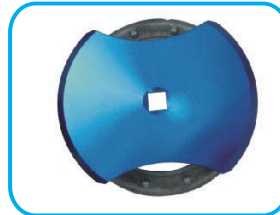

H.C.B-A1474 MINI COOPER WINDOW WRENCH

MINI COOPER 升降機調整扳手

- Hook wrench used for adjusting the door window glass.
- Hook wrench 300 mm long, need to release the star washer.
- This is the wrench to remove the large tooth nuts holding the door glass to the window regulator on R50, R52, R53 MINI Cooper and Cooper S.
- The wrench fits between the door glass and exterior seal to loosen or tighten the nuts to remove, install, and adjust the door glass. Commonly used during replacement of window motors, or door lock actuators.
- Application: BMW R53 2002-2006 Mini Cooper.
2002-2003 Cooper R50
2002-2003 Cooper S R53
2002-2006 Cooper R50
2002-2006 Cooper S R53
2005-2006 JCW Hardtop R53
2005-2008 Cabrio R52
2005-2008 Cabrio S R52
2005-2008 JCW Cabrio R52
- BMW OEM no. ref.: 513 240





H.C.B-A2024-8

OIL DRAIN PLUG REMOVER - 8 mm

放油螺塞拆卸器 -8 mm

- This Mini tool makes removal of the oil drain plug of new generation Mini a simple and pain free task.
- This is designed to give you plenty of leverage to loosen and remove your oil drain plug.



H.C.B-A1498

BMW FUEL PUMP REMOVAL/ INSTALLATION TOOL

BMW 汽油幫浦外蓋拆裝工具

- For removing and fitting the electrical fuel pumps with the aid of tool.
- Used for intended purpose.
- Tool is designed for releasing electrical fuel pumps from their mountings (Sleeve).
- The easy insertion on electrical fuel pumps into their mountings(Sleeve).
- Application: BMW E39/520i,523i,525i,528i,530i,535i,540i fuel pump.

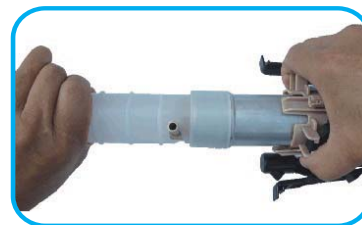

H.C.B-A1500

BMW (N20/N26/N46/N55) OIL FILTER PRESSURE CAP

BMW (N20/N26/N46/N55) 機油壓力工具

- This tool is used for testing oil pressure.
- Application: 2013 - N20 & N26 after 1/2012 and N46
- **BMW OEM no. ref.:** 119 250



(Use for N46)



(Use for N46)

H.C.B-A1511

MINI W16D DIESEL ENGINE TIMING TOOL

MINI W16D 柴油引擎正時工具組

- This tool is designed for timing belt replacement and chain in head service operations.
- Suitable for Mini with engine codes W16D16 (9HZ) and W16D16UO used on Mini, Mini Clubman (07-10) with chassis R55 /56 /57
- Also used on some Citroen and Peugeot models:
Citroen: 1.6 diesels in C2 | Xsara Picasso | C4 | C5 |C4 Picasso | Grand Picasso | Berlingo
Peugeot: 1007 | 206 | 307 | 207 | 308 | Partner Mk3
- **BMW OEM no. ref.:** 119 790,110 300,119 851,119 852.

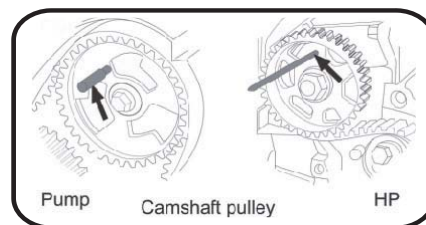

Pump

Camshaft pulley

HP



Parts No.	BMW OEM no. ref.	Description
1	119 790	Crankshaft timing pin
2	110 300	Camshaft/high pressure fuel pump timing pin (2)
3	119 851 (Part 1 of 11 9 850)	Flywheel holding tool
4	119 852 (Part 1 of 11 9 850)	Fixing Bolts for Flywheel Holding Tool

H.C.B-J2016 BMW/BENZ (W140) ENGINE LIFTING BAR PAT. M481854

BMW/BENZ (W140) 引擎吊架 PAT. M481854

- Put the prop at the front of engine frame. Then put the blue bar on the prop, make the blue bar into the hook. Fix the backend on the shock absorber.
- The design will make change engine socket or change oil pan conveniently and easier.
- Application: BMW (N52/ N62), BENZ (W140).

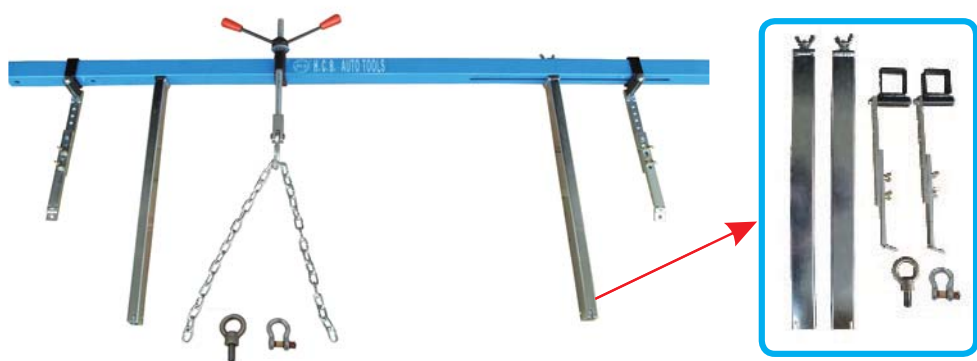

on BMW(E65)



on BENZ(W140)

H.C.B-A1659 **NEW** BMW (S85) CLUTCH ALIGNMENT TOOL

BMW (S85) 離合器校正工具

- For M6 E63, M5 E60, E61 chassis - S85 engine.
- BMW OEM no. ref.: 83 30 0 495 136 (212 300)





010

HWANG CHERNG BIN
Specialty Tools Inc.



BMW 變速箱修護工具
BMW TRANSMISSION REPAIR TOOL

H.C.B-A1010

AUTOMATIC TRANSMISSION CLUTCH SPRING COMPRESSOR (IMPROVEMENT)

自動變速箱離合器壓板拆裝工具 (改良型)

6 / 17.8 / 21.5 / 3.06'

- To remove and install the transmission rear clutch piston snap ring.
- Application: Most of American cars and light trucks.



H.C.B-A1100

BMW (5HP18/ 5HP19) TRANSMISSION SOCKET (4 TEETH)

BMW (5HP18/ 5HP19) 變速箱專用套筒 (4 齒)

- Dr. 1/2", for grooved nut on transmission drive shaft flange.
D = 64 mm
d = 53.5 mm
- Application: BMW (5HP18/ 5HP19) transmission.



H.C.B-A1101

BMW (5HP24/ 5HP30) TRANSMISSION SOCKET (6 TEETH)

BMW (5HP24/ 5HP30) 變速箱專用套筒 (6 齒)

- Dr. 1/2", for grooved nut on transmission drive shaft flange.
D = 74 mm
d = 63.5 mm
- Application: BMW (5HP24/ 5HP30) transmission.



H.C.B-A1352

BMW LINE DISCONNECT TOOL

BMW 油管分離器

- The application of this remover covers both power steering & transmission oil cooler line.
- Application: BMW 3-Series and X5, year 1999-2005.

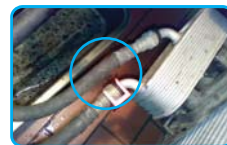

H.C.B-B1352

BMW (E83/E90) LINE DISCONNECT TOOL

BMW (E83/E90) 油管分離器

- The application of this remover covers both power steering and transmission oil cooler line.
- Application: BMW, especially useful on 2006-2011 3 Series models and 2006-2009 X3 models. (E90 and E83)

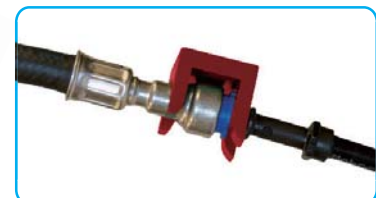



H.C.B-A1085

BMW THMR1 TRANSMISSION EXTRACTION/ INSTALLATION TOOL KIT

BMW THMR1 變速箱拆裝工具組

1 / 11.9 / 12.8 / 0.85"

- This set of tool is designed for extracting and installing BMW THMR1 transmission.



H.C.B-A1085-7

BMW THMR1 TRANSMISSION PUMP ALIGNMENT PIN

BMW THMR1 變速箱泵浦定位銷

- For aligning the center position of transmission pump.
- Work with A1085 kit.



H.C.B-A1356

BMW OIL COOLER LINE PLIERS

BMW 變速箱油冷卻管拆卸鉗

- The tool is designed to release the hydraulic cooling lines which are connected to transmission. It's very hard to release the connectors without using these pliers.
- To adjust the angle by turning the screws on the front clips.
- Application on the following BMW models:
 - 1 Series - E81/ E82/ E87
 - 3 Series - E46/ E90/ E91/ E92/ E93
 - 5 Series - E60/ E61
 - 6 Series - E63/ E64
 - 7 Series - E65/ E66
 - X3 - E83
 - X5 - E53/ E70
 - Z4 - E85/ E86
 - BMW MINI - R50/ R52/ R53
- BMW OEM no. ref.: 170 030.



H.C.B-A1456

BMW 5L 40 TRANSMISSION REMOVAL/INSTALLATION TOOL KIT

BMW 5L 40 變速箱拆裝工具組

■ This tool is used for removing and installing BMW 5L 40 transmission.



Fig1



Fig2



Fig3

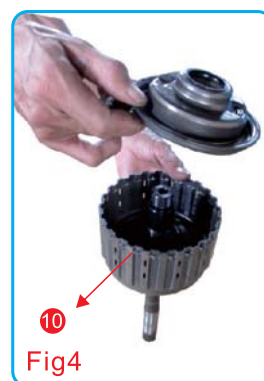

Fig4

■ Put No.11 first and then put part seal on it,then remove No-11,and install No.10



Fig5



Fig6



Fig7



010
HWANG CHERNG BIN
 Specialty Tools Inc.

BMW Transmission

H.C.B-A1566 BMW DCT DUAL CLUTCH REMOVER/ INSTALLER

BMW DCT 離合器拆裝工具

H.C.B-B1566 BMW DCT CLUTCH COVER ALIGNMENT TOOL

BMW DCT 離合器蓋校正工具

H.C.B-C1566 BMW DCT OUTPUT SHAFT SEAL INSTALLER

BMW DCT 輪軸油封安裝工具

H.C.B-D1566 BMW DCT FRONT TRANSMISSION COVER REMOVAL ALLEN HEAD SOCKETS

BMW DCT 前變速箱蓋拆六角頭套筒

H.C.B-A1566

- Special designed to remove and install the dual clutch.
- Applicable to BMW GS7D36SG (DKG) transmission.
- **BMW OEM no. ref.:** 23 0 400



H.C.B-B1566

- This tool was developed to remove and install the clutch cover with the sealing ring on the shaft.
- Also compatible with the 2008-14 M3,135i, 335iS, F10 M5, and F12/3 M6 with the DCT transmission.
- **BMW OEM no. ref.:** 230 390



H.C.B-C1566

- BMW seal cover alignment tool for the output shaft.
- Also compatible with the 2011-14 135i, 335iS, F10 M5, and F12/3 M6 DCT.



H.C.B-D1566

- BMW front transmission cover removal allen head sockets
- Also compatible with the 2008-14 M3, 135i, 335iS, F10 M5, and F12/3 M6 with the DCT transmission.





010
HWANG CHERNG BIN
Specialty Tools Inc.

BMW變速箱修護工具
BMW Transmission Repair Tool

BMW Transmission

H.C.B-A1649 **NEW** BMW (E70/E90/E91/E92) FINAL DRIVE INPUT SHAFT SEAL INSTALLER

BMW (E70/E90/E91/E92) 終傳輸入軸油封安裝器

- Used to install the final drive input shaft seal.
- Application: BMW E90/E91/E92 and E70 with N54 B30.
- **BMW OEM no. ref.:** 83 30 0 495 593 (335 080).



H.C.B-A1650 **NEW** BMW (E70/E90/E91/E92) FINAL DRIVE INPUT SHAFT SEAL SOCKET

BMW (E70/E90/E91/E92) 終傳輸入軸油封螺帽套筒

- Designed for holding the input shaft on the final drive when replacing the seal.
- Application: BMW E70/E71/E72/E82/E84/E90/E91/E92/E93/F12/F13/F20/F25.
- **BMW OEM no. ref.:** 83 30 0 495 553 (335 060).

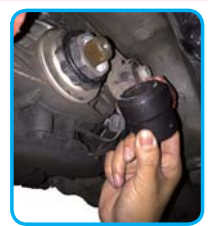

H.C.B-A1651 **NEW** BMW (E70/E90/E91/E92) DRIVESHAFT INNER NUT WRENCH

BMW (E70/E90/E91/E92) 傳動軸內螺帽扳手

- Size: H50
- Designed for R&R the driveshaft inner nut (final drive end).
- Application: BMW E70/E90/E91/E92 with N54 B30 engine.
- **BMW OEM no. ref.:** 83 30 0 495 551(335 040).

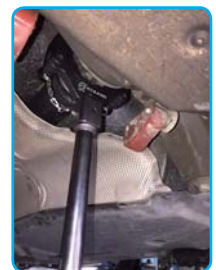

H.C.B-A1652 **NEW** BMW (E70/E90/E91/E92) DIFFERENTIAL FLANGE NUT WRENCH

BMW (E70/E90/E91/E92) 差速器凸緣盤螺帽扳手

- Size: H65
- Designed for loosening the flange nut on the E70 rear axle differential.
- Application: BMW E70/E90/E91/E92 with N54 B30 engine.
- **BMW OEM no. ref.:** 83 30 0 495 552 (335 050).



H.C.B-A1653 **NEW** BMW EXTENSION BAR

BMW 延長桿

- Extension bar for A1651 and A1652.
- **BMW OEM no. ref.:** 83 30 0 495 554 (335 070).





010

HWANG CHERNG BIN Specialty Tools Inc.

福特修護工具

FORD REPAIR TOOL





010
HWANG CHERNG BIN
 Specialty Tools Inc.

福特修護工具
FORD Repair Tool

Ford Repair Tool

H.C.B-A1031 FORD LASH ADJUSTER

FORD 嘉年華全壘打斜式培林間隙搖桿

- A lash adjuster for aligning the front wheel axles bearings.
- Application: Ford Festiva Laser (bearing-69349)
- N.W.: 1.5 KGS



H.C.B-A1041 8 PCS BEARING RACE & SEAL DRIVER KIT

8 PCS 斜式培林安裝器

- Can quickly & easily insert wheel bearing races & axles without damaging the race & axle housing.
- 7 sizes of discs can fit most standard wheel bearings.
- The other side of the disc can evenly drive seals.
- N.W.: 1.5 KGS

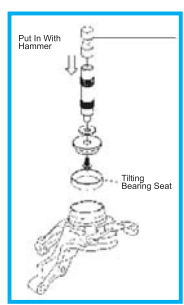

H.C.B-A1046 FORD BRAKE PAD EXTRACTOR/INSTALLER

FORD 煞車襯套拆裝器

- This tool is designed for removing and installing the brake pad.
- N.W.: 0.2 KGS



H.C.B-A1196 FORD (ESCAPE, METROSTAR) CRANKSHAFT PULLEY HOLDING TOOL

FORD (ESCAPE, METROSTAR) 曲軸支撐扳手

- For removing and installing the crankshaft bolt on FORD ESCAPE and METROSTAR.
- This well-designed tool is used to prevent pulley from rotating when extracting the central fixed screw.
- Application: FORD ESCAPE (2300 c.c.) and METROSTAR



H.C.B-A2131 FORD METROSTAR CALIPER WIND BACK PENTAGON SOCKET

FORD METROSTAR 煞車分泵五角套筒

- N.W.: 0.07 KGS





H.C.B-A1150

3 PCS PETROL ENGINE SETTING/ LOCKING KIT (FOR FORD & MAZDA)

3 PCS FORD, MAZDA 正時工具組

- Old version contains only camshaft setting and locking plate. The application of this updated kit now covers FOCUS, MONDEO, ESCAPE and COUGAR equipped ZETEC engines after 1998.
- Also suitable for FORD 1.6, 1.8 and twin cam 16V petrol engines.
- Can lock crankshaft to TDC location for FORD 1.25 and 1.4 engines plus the puma 1.7 engines. TDC pin also suitable for MAZDA 121 1.25 petrol engines.
- N.W.: 0.33 KGS



H.C.B-A1107

FORD METROSTAR TIMING PIN

FORD METROSTAR 正時插銷

- Application: FORD, ESCAPE (2300 c.c.), METROSTAR, MAZDA 3 and FOCUS 1.8L/2.0L



H.C.B-B1107

FORD/ MAZDA TDC TIMING PINS

FORD/ MAZDA TDC 正時插銷

- The application of this updated set now covers zetec engines equipped on Focus, Mondeo and Cougar after 1998. Cougar after 1998.
- Also covers Ford 1.6, 1.8, twin cam 16v petrol engines, and Mazda 121 1.25 L petrol engine.

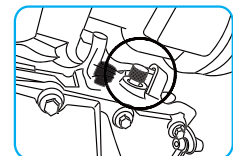
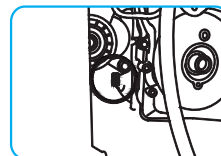

H.C.B-A2006-1

FORD MONDEO SETTING PIN

FORD MONDEO 正時插銷



H.C.B-A2006

FORD MONDEO SETTING BAR

FORD MONDEO 正時工具

- For holding camshaft in place.
- Application: FORD MONDEO
- N.W.: 0.2 KGS

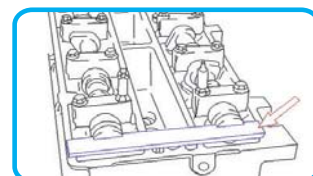

H.C.B-A2007

FORD TELSTAR SETTING BAR (IMPROVEMENT)

FORD 天王星正時工具 (改良型)

- For holding camshaft in place.
- Application: FORD TELSTAR
- N.W.: 0.6 KGS



H.C.B-A2208

FORD FLYWHEEL LOCKING TOOL

FORD 飛輪固定工具

- For holding the flywheel and crankshaft at the correct timing position.
- Locking plate is to lock flywheel, the adaptor is for adjusting to fully engage the flywheel ring gear.
- Three adaptors are included.
- Application: Ford diesel and petrol engines.
- **FORD OEM no. ref.:** 303-393A/ 21-168A
303-393-01, 303-313-02



Focus 2.0 TDCi Focus C Max 2.0 TDCi	G6DA, G6DB, G6DC
Focus 1.6T – VCT Focus C Max 1.6Ti – VCT	HXDA
Fiesta 1.8D Turbo	C9DC RTN RTP RTZ, Chain engines
Focus 1.8 / TDDi / TDCi	BHDA / B C9DC, C(DA / B FFDA F9DA / B) KKDA – Chain engines
Focus C Max 1.8 TDCi	KKDA – Chain engines
Toumeo Connect 1.8, TTDi / TDCi	BHPA HCPA HCPB, Chain engines
Transit Connect 1.8, TDDi / TDCi	BHPA HCPA HCPB, Chain engines

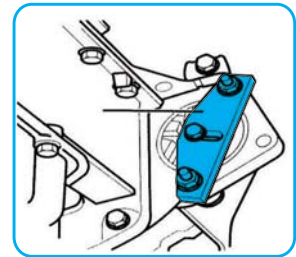

H.C.B-A1375

FORD 1.6 16V Ti-VTC TIMING TOOL

FORD 1.6 16V Ti-VTC 正時工具

- To lock the position of camshaft, crankshafts and time belt tensioners, as well as for adjusting the VTC-unit
- Application:
Ford 1.6 16V Ti-VCT twin camshaft Duratec petrol engines (HXDA), e.g. Ford Focus, C-Max and Mondeo.
Ford 1.25, 1.4, 1.6, 1.7, 1.8 and 2.0 TwinCam Duratec petrol engines (timing belt or timing chain) e.g. Ford Fiesta/Courier, Fusion, Focus, C-Max, Cougar, Galaxy, Mondeo, Puma and Tourneo, Transit Connect

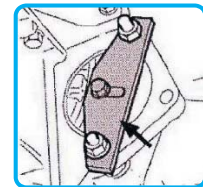

H.C.B-B1375

FORD & MAZDA PETROL ENGINE TIMING TOOL

FORD & MAZDA 汽油引擎正時工具

- Application:
Ford: Cougar 2.0 (98-01), Fiesta 1.25/1.4/1.6 (95-08), Focus 1.4/1.6/1.8/2.0 (98-08), Focus C-Max 1.8/2.0 (02-08), Fusion 1.25/1.4/1.6 (02-08), Mondeo 1.8/2.0 (98-08), Puma 1.7 (97-02), Tourneo Connect 1.8 (02-06), Transit Connect 1.8 (02-06)

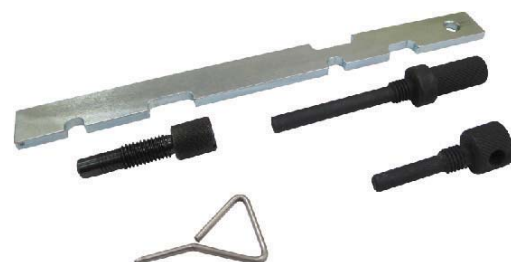



H.C.B-A2217

FORD 1.6 Ti-VCT TIMING TOOL KIT

FORD 1.6 Ti-VCT 正時工具組

- For replacing the cam belt on Ford Focus / C-Max 1.6 Ti-VCT with engine code HXDA (2003-2007), plus 2.0 TDCi with engine codes G6DA, G6DB, G6DC (2003-2007).

- Kit covers timing belt replacement on Ford 1.6 Duratec engines with variable valve timing. Camshaft, crankshaft and flywheel pins are also suitable for many other petrol and diesel Ford engines.

- FORD OEM no. ref.:** 303 1097, 303 1059, 303 1054, 303 735, 303 748



H.C.B-A1449

FORD V8 CAM TOOLS

FORD V8 正時工具組

- Used for cam timing when servicing timing belts, chains, head gaskets, or other valve train repairs.
- Saves time; all tools required for camshaft timing are in one kit.
- Application: FORD 1993-2006, Lincoln, Mercury vehicles with 4.6 L 4 Valve engine.

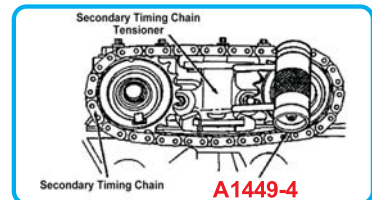
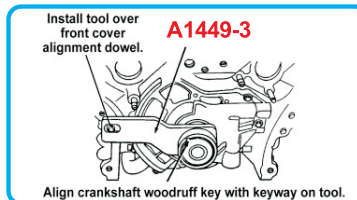
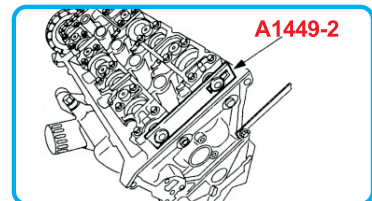
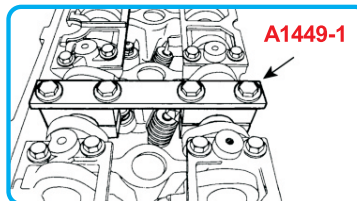

H.C.B-A1433

FORD DURATEC TIMING PIN

FORD 正時插銷

- For locking the crankshaft at the TDC position.
- Application: FORD transit connect 2.0 L DURATEC





福特修護工具
FORD Repair Tool

H.C.B-A1620 **NEW** FORD/MAZDA SERPENTINE BELT TOOL (TDCI)

FORD/MAZDA 惰輪皮帶調整扳手 (TDCI)

- Special design for turning the idler and replace the serpentine belt easily.
- For diesel engine 2.0 L.
- Application: FORD: DW10A, DW10B 2.0TDCI



H.C.B-A4013 FORD 2.0/2.2/2.4 TDDi/TDCi DURATORQ ENGINE TIMING TOOLS

FORD 2.0/2.2/2.4 TDDi/TDCi DURATORQ 柴油引擎正時工具組

- Application:
Ford: Focus, C-Max, S-Max, Mondeo, Nuova Focus, Transit, New Galaxy (Engine: 2.0 TDCi, 2.2 TDCi, 2.4 TDCi)
Jaguar: X-Type (Engine: 2.0 D, 2.2 D)
Land Rover: Defender (Engine: 2.4 TD4)
- Applicable engine codes:
FMBA/B, D5BA, ABFA, D3FA, D6BA, HJBA/B, F3FA, D2FA, D4FA, F4FA, F1FA, DOFA, QJBA, QJBB, FXFA, H9FA, 244DT



H.C.B-A1530 FORD MONDEO MK4 TRAILING ARM BUSH REMOVER/ INSTALLER

FORD MONDEO MK4 後游臂鐵套拆裝工具組



OEM number:
140.781 E3B2B



Installation



Removal

- Application: FORD MK4 MONDEO (2007 and after)

Ford Repair Tool



H.C.B-A1510

ON CAR

FORD FOCUS & MAZDA 3 REAR TRAILING ARM BUSH REMOVER/ INSTALLER

FORD FOCUS & MAZDA 3 後游臂鐵套拆裝工具組



■ Introduction

This trailing arm bush kit has been designed and developed to quickly, simply and correctly extract and install the rear arm bush. This tool can insert the bush to the correct depth. It's the best tool kit in the market!

■ Application: FORD FOCUS & MAZDA 3

■ NOTE!

The tool will insert the bush to the correct depth, But before installing the new bush, Refer to the vehicle manufacturer's service instructions, Or a proprietary manual, to establish the correct horizontal alignment/ positioning of the bush in the trailing arm.



New FORD FOCUS 98-04 front suspension trailing arm bush



Black Part for Removal Golden Part for Installation

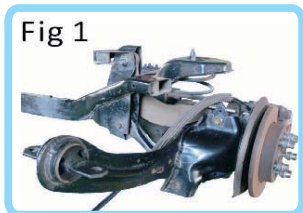

Fig 1



Fig 2



Installation

Removal

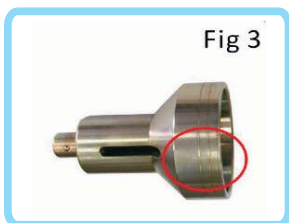

Fig 3

No.5 : 75.5 mm Installing Sleeve

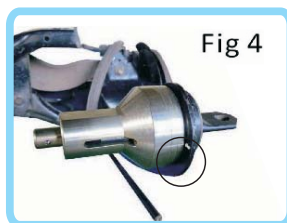

Fig 4

Refer to Fig.4. Before extraction, use NO.5 sleeve to fit the old bush and mark the position where white line point

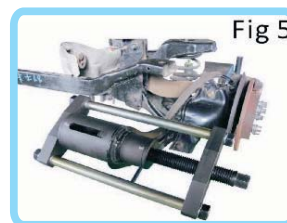

Fig 5

Extraction :
Refer to Fig.5. Assemble components as show. As force bolt 1-3 is turned with a wrench or socket and ratchet, double-check the alignment of the tools as the load is applied

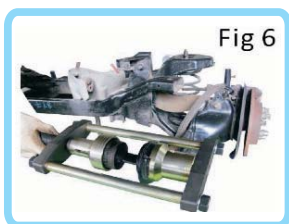

Fig 6

Installation :
Refer to Fig.6 : fit new bush into No.5 sleeve.Slot design of No. 4 should align to raised point. White line on No.5 should align to mark.It will be perfectly complete while turning 1-3 force bolt to tighten up.

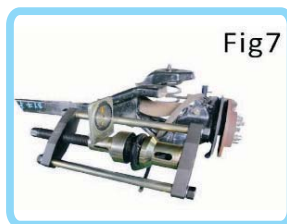

Fig 7

Finally, put on a angle gauge, angle should be 90 degree.



010
HWANG CHERNG BIN
 Specialty Tools Inc.

福特修護工具
FORD Repair Tool

Ford Repair Tool

H.C.B-A1532 FORD UPPER A ARM BALL JOINT REMOVAL/ INSTALLATION TOOL

FORD 雙 A 臂上三角架球接頭拆裝工具

- Regular maintenance as following is required:
 Keep jacking screw thread clean and lubricated at all times.
 Lubricate end of Jacking screw with a lithium based grease to prevent excessive wear on the Jacking surfaces.
 Do not apply excessive force to hand press.
 Do not use impact guns on this tool (Will void warranty)
 A selection of spacers always comes in handy (old bearing races are useful).
 Fit a piece of tubing over the threaded end of the ball joint to guide it through the tool.



H.C.B-A1563 FORD DIFF SUPPORT BUSH REMOVAL/ REPLACEMENT TOOL

FORD 差速器鐵套拆裝工具組

- To carry out replacement of the 3 rear differential bushes on Fords ranging from BA-FG as well as the popular Ford Territory. This kit allows you to remove and install the three rear differential bushes on car without dropping the subframe.
- The differential will need to be lowered about 10 cm to gain access to the bushes but this still saves a huge amount of time.



H.C.B-A1583 FORD FOCUS/ MAZDA 3 FRONT WHEEL HUB/ WHEEL BEARING REMOVAL / INSTALLATION TOOL KIT - 82 mm

FORD FOCUS /MAZDA 3 前輪軸培林拆裝工具組 -82 mm

Description:

- For removing and installing the wheel hubs and bearings on Ford models.
- Application:
 FORD FOCUS II front axle (since 2004)
 FORD C-Max front axle (since 2007)
 VOLVO C30, C70 front axle (since 2006)
 VOLVO S40, V50 front axle (since 2004)
 MAZDA 3 1.4i/1.6i/2.0i/1.6Di Turbo front axle (since 2003)



Removal

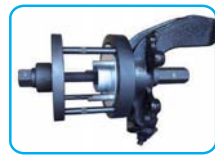

Installation

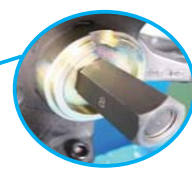



010

HWANG CHERNG BIN
Specialty Tools Inc.

福斯修護工具

VW REPAIR TOOL

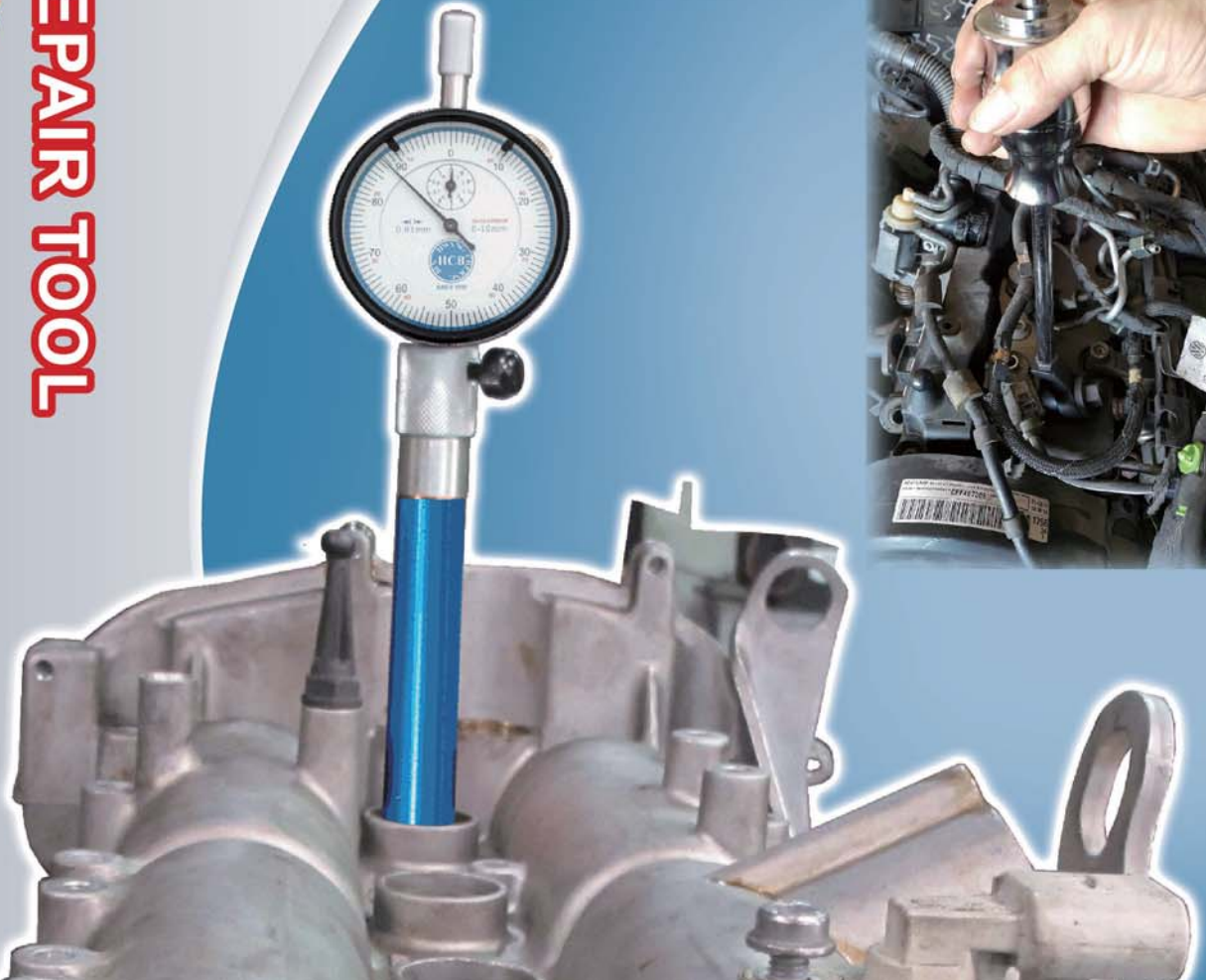

H.C.B-A1045 VW / AUDI STRUT SOCKET

VW/ AUDI 避震器座拆卸套筒

- For removing and installing the top shock retaining nut on most FWD, VW and AUDI.
- Fit the slot on the top of strut retaining nut 22 mm (Dr.7/8") hex for using with a wrench.
- N.W.: 0.1 KGS



H.C.B-A1053 VW T4 SUB-FRAME BUSH EXTRACTOR/ INSTALLER

VW T4 三角架鐵套拆裝工具組

5 / 18.8 / 20 / 1.59'

- Used for R&R rear wheel bearing located in wheel carrier.
- This tool is also used on installing the rear axle shaft flange.
- Application: VW T4



H.C.B-A1055 VW/ AUDI FRONT AXLE CAMBER ADJUSTER

VW/ AUDI 前軸外傾角調整工具

- For removing the subframe to adjust camber.
- Application: VOLKSWAGEN, AUDI A3, A4, B5 and new PASSAT.



H.C.B-A1078 SPARK PLUG ELECTRIC WIRE REMOVER (VW VR6, PASSAT, BENZ V-CLASS)

火星塞高壓線拔取器 (VW VR-6, PASSAT, BENZ V-CLASS)

- The tool is designed to separate the electric wire from spark plug.
- Application: VW VR6, PASSAT, BENZ V-CLASS, AUDI V6.
- N.W.: 0.24 KGS





H.C.B-A1080

VW DIESEL 2400 c.c. CAMSHAFT ALIGNMENT TOOL

VW 柴油 2400 c.c. 偏心軸正時工具組 (含插銷)

- Lock the camshaft on the proper position to allow the drive belt to be removed or replaced.
- N.W.: 1.1 KGS G.W.: 1.2 KGS
- **VW OEM no. ref. :** 2065A, 2064.

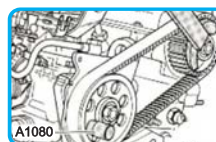
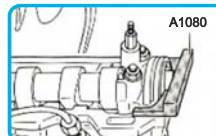

H.C.B-A1424

VW/AUDI A6&A8 ADJUSTABLE TIMING TOOL

VW/ AUDI A6&A8 可調式正時工具

- For holding the camshafts at TDC position when replacing timing belt.
- Application :
AUDI: A6, A8, S4, ALLROAD (95-04) 80 (91-96), A4 (94-99), Coupe (91-96), Cabriolet.
VW: PASSAT (96-04) with codes: ACK, AGA, AGB, AJG, ALF, ALG, ALW, AML, AMM, AMX, APR, APS, APZ, AQD, ARE, ARJ, ASM, BDV, BES.



H.C.B-A1105

VW/AUDI V6 CAMSHAFT SETTING PLATE

VW/ AUDI V6 引擎正時工具

10 / 22 / 24.8 / 1.53'

- For holding the camshafts at TDC position when replacing timing belt. A1105-4 (optional accessory) is a locking pin.
- Application: Audi: 80 (91-96), A4 (94-99), Coupe (91-96), Cabriolet (91-100), A6 (94-97), A8 (94-00).
- P.C.D.: 515 mm.
- **VW OEM no. ref. :** 3243

H.C.B-A1105-3
Knurled wheel

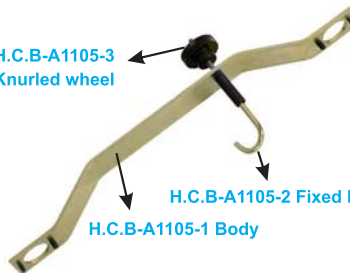

H.C.B-A1105-2 Fixed hook

H.C.B-A1105-1 Body



H.C.B-A1161

VW/AUDI V6 CAMSHAFT SETTING PLATE

VW/ AUDI V6 引擎正時工具

10 / 21.62 / 24.3 / 1.77'

- For holding the camshafts at TDC position when replacing timing belt. Conjunction with H.C.B-A1105-4 (optional accessory).
- Application:
AUDI: A4, A6, A8, S4, ALLROAD (95-04)
VW: PASSAT (96-04) WITH CODES: ACK, AGA, AGB, AJG, ALF, ALG,ALW, AML, AMM, AMX, APR, APS, APZ, AQD, ARE, ARJ, ASM, BDV, BES.
- P.C.D.: 616 mm.
- **VW OEM no. ref. :** 3391.





010
HWANG CHERNG BIN
 Specialty Tools Inc.

福斯修護工具
VW Repair Tool

VW Repair Tool

H.C.B-A1205 VW/ AUDI V8 CAMSHAFT ALIGNMENT TOOL

VW/ AUDI V8 正時工具

10 / 14.6 / 18 / 1.07'

- For holding the camshafts at the TDC position while replacing the timing belt. Conjunction with H.C.B-A1105-4. (Optional accessory)
- Applicable engine model:
 AUDI: A6/ Quattro (99-05), S6 (00-04), A8 (99-06), S8 (99-03), RS4 (03-05), RS6 (03-04).
 VW: Touran (03-06), Phaeton (03-04).
- P.C.D.: 622 mm
- VW OEM no. ref.: T40005



H.C.B-A1105-4 VW/ AUDI PETROL V6 CRANK LOCKING PIN

VW/ AUDI V6 引擎正時插銷

- For locking the crankshaft at the TDC position when replacing timing belt or removing crankshaft bolt.
- Application: V6, V8 engine
- VW OEM no. ref. : 3242.



Size: M18*P1.5

H.C.B-A1105-5 VW/ AUDI V6 CRANK LOCKING PIN

VW/ AUDI V6 正時插銷

- For locking the crankshaft at the TDC position when replacing timing belt or removing crankshaft bolt.
- Application: V6, V8 engine
- VW OEM no. ref. : T40062



Size: M12*P1.5

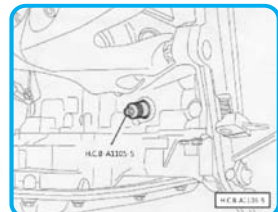

H.C.B-A1105-6 VW/ AUDI (2.0,2.4,2.8,3.0,3.2 FSI) CRANKSHAFT LOCKING PIN

VW/ AUDI (2.0,2.4,2.8,3.0,3.2 FSI) 正時插銷

- For locking the crankshaft at the TDC position when replacing timing belt or removing crankshaft bolt.
- Application:
 VW/Audi engines: 2.5L 5 cyl. (BGP, BGQ, BPR, BPS, CBTA and CBUA) 3.2L V6 4v (BKH and CALA) 2.0, 2.4, 2.8, 3.0, 3.2 FSI
- Size: M14 x P 1.5
- VW OEM no. ref. : T40069



H.C.B-A1105-7 VW/ AUDI (1.4,1.6 FSI ,TSI) CRANKSHAFT LOCKING PIN

VW/ AUDI (1.4,1.6 FSI ,TSI) 正時插銷

- For locking the crankshaft at the TDC position when replacing timing belt or removing crankshaft bolt.
- Size: M14 x P 1.5
- VW OEM no. ref. : T10340





H.C.B-A1160

VW VIBRATION DAMPER COUNTER HOLDER

VW 曲軸油封更換器

- Lock the position of vibration damper and crankshaft sprocket when removing to replace front crankshaft seal.
- Application: VW T4 2.4 / 2.5, T5.
- N.W.: 2.08 KGS.



H.C.B-A1108

ON CAR

VW T4 FRONT AXLE UPPER BALL-JOINT EXTRACTION/ INSTALLATION TOOL KIT PAT. I 233868 DE PAT.

VW T4 前上三角架球接頭拆裝工具組

5 / 19 / 20 / 1.77'



T4 2000CC AXLE



T4 2500CC AXLE

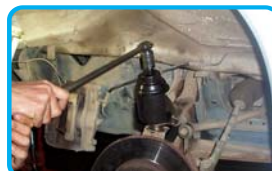
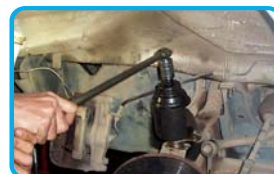

- Suitable for removing and installing the upper front ball joint on-vehicle without the need of disassembly.
- Features a variety of adaptors used in different combinations for extraction and installing.
- Application: VW T4 (2000 c.c.), T4 (2500 c.c.)

H.C.B-A1162

VW VR6 CAMSHAFT ALIGNMENT TOOL

VW VR6 引擎正時工具組

- To locate the camshaft in proper position for timing when assembling the VR6 engine.
- Application:
Ford:Galaxy VR6 (95-00), Seat; Toledo (99-05),
VW:Corrado (92-95), Bora/ Golf (97-04), Passat (91-05), Sharan (95-00), Transporter (96-03), Vento (91-97).
- N.W.: 0.302 KGS
- VW OEM no. ref. : T10068, 3268.

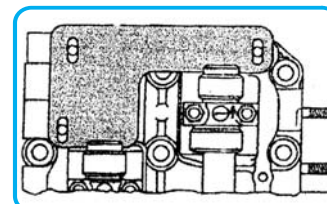



010
HWANG CHERNG BIN
Specialty Tools Inc.

福斯修護工具
VW Repair Tool

VW Repair Tool

H.C.B-A1164 VW/AUDI PETROL 1.4 & 1.6 16V TWIN CAMSHAFT ALIGNMENT TOOL KIT

VW/ AUDI 1.4 & 1.6 16V 引擎正時工具組

50 / 16.7 / 17.8 / 0.89'

- It is convenient for working and adjusting the timing on crankshaft.
- Application: AUDI : A2 (00-04)
SEAT : AROSA 1.4(99-05), CorDOBA 1.4(99-08) Lbiza 1.4(99-08) Inca 1.4 (00-04) Leon 1.4, 1.6 (99-05), Toledo 1.4,1.6(99-05) Skoda; Fabia 1.4(99-05), Octavia 1.4 (99-05), VW; Beetle 1.4, 1.6(01-08), Bora 1.4 1.6(97-08), Caddy 1.4 1.6 (99-08), Golf 1.4, 1.6 (97-08), Lupo 1.4 1.6 (98-05), Polo 1.4, 1.6 (98-07).
- VW OEM no. ref. : T10074/ T10016.



H.C.B-A1195 VW, BMW SOCKET (Dr. 1/2" , 12 POINTS, 21 mm)

VW, BMW 避震器固定套筒 (Dr. 1/2" , 12 角 , 21 mm)

- For installing and removing the front strut units on VW-GOLF 2 and JETTA since 1987, GOLF 3 and VENTO since 1993, PASSAT since 1988 and some PORSCHE.
- For loosening shock absorbers bolt on BMW E38, E39, E46, E52, E53, E60, E61, E63, E64, E65, E66, E83, E85, E86, E87, E90, E91, E92, E93, R50, R52, R53
- Drive 12.5 = 1/2"
- Chrome – Vanadium.
- Surface chrome-plated.
- N.W.: 0.142 KGS.



Dr. 1/2"



H.C.B-B1195 VW, BMW SOCKET (Dr. 1/2" , 12 POINTS, 22 mm)

VW, BMW 避震器套筒 (Dr. 1/2" , 12 角 , 22 mm)

- For releasing shock absorber retainer nut of most European models
- Allow easy combination with an adjusting wrench
- Application: BMW E38, E39, E46, E52, E60, E61, E63, E64, E65, E66, E83, E85, R50, R52, R53 and VW Volkswagen , Audi , Mercedes
- N.W.: 0.159 KGS



Dr. 1/2"



H.C.B-A1200 IDLER PULLEY WRENCH

惰輪調整器

- For adjusting the toothed belt on the automatic tensioning pulley.
- Especially for VW Polo Diesel, AUDI 100 since 1991, AUDI A6 with 2.5 L TDi engine.
- S: 32 mm
- Special steel
- Surface mat chrome-plated, handle plastic coated.





H.C.B-A1212

VW RIBBED BELT TENSIONING WRENCH

VW 正時張力皮帶調整扳手

- For holding V belt tension when removing and installing the V-belt.
- Application: VW - GOLF, JETTA, GTI, T4 1991-1999 , AUDI - A6.
- Engines: 1Z, AAB, AAZ, AAF, ABA, ACC, ACU, ACV, AHU, AVK.
- N.W.: 0.8 KGS.

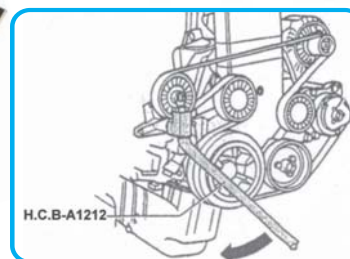

H.C.B-A1213

VW/ AUDI CLUTCH RETAINING BAR

VW/ AUDI 離合器安裝固定器

- Application: GOLF 2004 >, TOURAN 2004 >, AUDI A3 2004 > , AUDI TT 1999> .
- Direct shift gearbox 02E
- For assembly of multiple clutch
- N.W.: 0.114 KGS



H.C.B-A1214

VW/ AUDI CAM CHAIN TENSIONER RETAINER

VW/ AUDI 固定凸輪軸調整器

- For holding the chain and tensioner in position when assembly and disassembly.
- Application:
AUDI: AHA, AMB, AMU, APB, ART, ATC, ATQ, AWM, AWN, AWP, BBD, BCY, BEA, BEL, BFM
VW: AHA, APH, ATQ, AUG, AWM, AWP, AWV, BKF, BNU 1998-2006
- N.W.: 0.04 KGS
- VW OEM no. ref. : 3366



H.C.B-A1215

AUDI V6 FAN CLUTCH FIXING WRENCH

AUDI V6 風扇離合器固定扳手

- For removing and installing the viscous clutch radiator fan and the central hydraulic pump pulley.
- N.W.: 0.252 KGS.

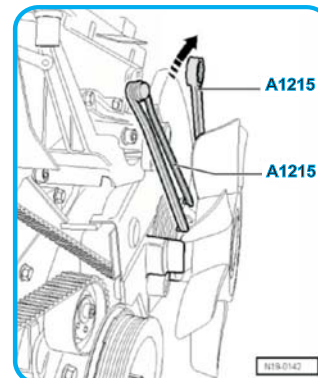
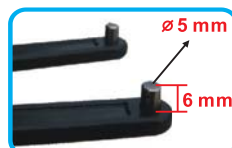



010
HWANG CHERNG BIN
Specialty Tools Inc.

福斯修護工具
VW Repair Tool

VW Repair Tool

H.C.B-B1215 VW PASSAT / AUDI A4 FAN CLUTCH FIXING WRENCH

VW PASSAT / AUDI A4 風扇離合器固定扳手

- For removing and installing the viscous clutch radiator fan and the central hydraulic pump pulley.
- Application: VW/ AUDI A6 (1995).

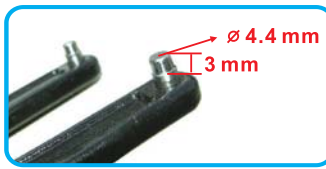

H.C.B-A1217 VW/ AUDI FUEL SENDER WRENCH

VW/ AUDI 油箱蓋拆裝器

- For removing and installing the fuel gauge sending unit (139 mm).
- Dr.1/2".
- Application: M-Benz, BMW. Some VW/ Audi and Porsche Boxster/ 911.
- N.W.: 0.492 KGS



H.C.B-A1218 VW/ AUDI CV JOINT BOOT CLAMP TOOL

VW/ AUDI 防塵套束裝器

- Tool for applying single ring clips, used on outer CV joint boots of drive shafts on GOLF and PASSAT, all AUDI models, FORD, OPEL and VAUXHALL...etc.
- Tool can also be used for assembling dustproof systems on Audi vehicles and to repair air spring on Audi A8, model year 2003 and onwards.
- The 3/8" torque wrench is deal to provide the drive.
- N.W.: 1.204 KGS.
- VW OEM no. ref. : VAG 1682.

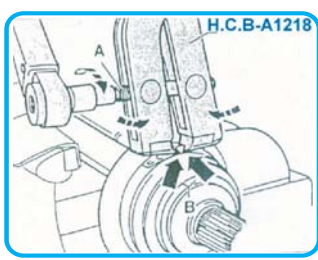

H.C.B-A1219 VW/ AUDI SPARK PLUG ELECTRIC WIRE PULLER

VW/ AUDI 火星塞高壓線拔取器

100 / 16.8 / 18.3 / 3.35"

- For new BEETLE and cars with 2.0 engine , VW GOLF IV & V with 1.6 engine, VW, AUDI, BORA, BENZ, SMART ... etc.
- For removing and installing spark plug connectors.
- Made of stainless steel.
- Length: 264 mm.
- VW OEM no. ref.: T10112.





H.C.B-A1231

VW OIL SEAL PULLER (27 mm) (Dr. 1/2")

VW 油封拆卸器 (27 mm) (Dr. 1/2")

- For removing camshaft oil seals.
- Application: VW LUPO1.4, NEW POLO 1.4
- N.W.: 0.424 KGS
- VW OEM no. ref. : T10018.

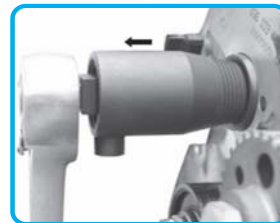

H.C.B-B1231

VW OIL SEAL DRIVER

VW 油封安装器

- For Installing camshaft oil seals.
- Application : VW LUPO 1.4, NEW POLO 1.4
- N.W.: 0.174 KGS.



H.C.B-A1232

VW OIL SEAL PULLER (32 mm)

VW 油封拆卸器 (32 mm)

- Remove crankshaft (early), camshaft and cam position sensor seals.
- Application: VW & AUDI, all engines except diesel.
- N.W.: 0.416 KGS.

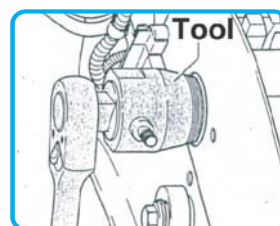

H.C.B-B1232

VW OIL SEAL DRIVER

VW 油封安装器

- For installing crankshaft pulley, camshaft and intermediate shaft oil seals, 4 pieces / set.
- Application: VW Golf, Rabbit, Fox, GTI, Scirocco, AUDI All except V8.
- N.W.: 0.5 KGS.
- VW OEM no. ref.: 10-203.



H.C.B-A1233

VW OIL SEAL PULLER (35 mm)

VW 油封拆卸器 (35 mm)

- For removing front crankshaft (pulley) seal at the vibration damper.
- Application: VW & AUDI late models.
- N.W.: 0.64 KGS.



H.C.B-B1233 VW OIL SEAL DRIVER

VW 油封安裝器

- For installing crankshaft oil seal (vibration damper end)
- Application: VW-VR6 engine.
- VW OEM no. ref.: 3266



H.C.B-A1234 VW OIL SEAL PULLER (32 mm) LONG BODY

VW 油封拆卸器 (32 mm)

- For removing left and right front camshaft oil seals.
- Application: VW VR6, AUDI V6
- N.W. : 0.902 KGS.

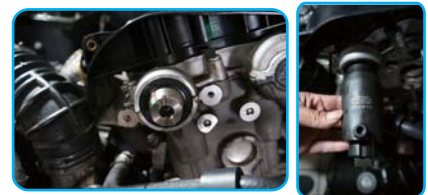

H.C.B-B1234 VW CAMSHAFT SEAL INSTALLER

VW 凸輪軸油封安裝器

- Used to press in camshaft oil seals.
- Application: Audi 2.7L & 2.8L V6 engines and VW
- VW OEM no. ref.: 3241.



H.C.B-A1230 VW/ AUDI DRIVING TOOL FOR TENSIONING DEVICE

VW/ AUDI 張力皮帶調整器

- For operating the tensioning device when changing the V-ribbed belt on VW Polo, GOLF and PASSAT, AUDI since 1991.
- Special steel.
- Surface chrome-plated.
- N.W.: 0.354 KGS.

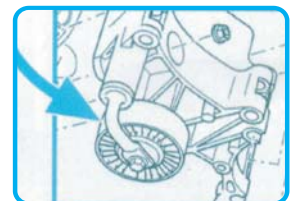

H.C.B-A2110 VW/ AUDI EXHAUST SPRING CLAMP REMOVER/INSTALLER

VW/ AUDI 排氣管 C 型夾拆裝器

- Essential for safe, controlled removal of clamps attached on exhaust manifold.
- Special design provides "leverage" required to expand the strong spring clamps.
- Application: VW / AUDI.
- N.W.: 0.44 KGS.





H.C.B-C1235

AUDI CAMSHAFT ADJUSTMENT GAUGE KIT (3.0L, V6, PETROL ENGINE)

AUDI 正時工具組 (3.0L, V6, 汽油引擎)

- For timing left and right camshafts of petrol engine.
- Include camshaft and crankshaft setting and locking tools , camshaft sprocket adjusting tool and tensioner retaining pins.
- Application:
Audi A4 3.0 V6 (2001~2008), Audi A4 Cabrio 3.0 V6 (2001~2008), Audi A4 Quattro 3.0 V6 (2001~2008), Audi A6 3.0 V6 (2001~2008), Audi A6 3.0 V6 (2001~2008), Audi A6 Quattro 3.0 V6 (2001~2008), Audi A8 3.0 V6 (2001~2008)
- Engine code: ASB, AVK, BBJ.



No.	Description	OEM no. ref.
1	Camshaft locking tools (Pair)	T40030
2	Crankshaft locking pin	T40026
3	Camshaft adjusting tool	T40028
4	Tensioner retaining pins	T40011
5	Spanner wrench for timing belt	

H.C.B-B1235

AUDI CAMSHAFT ADJUSTMENT GAUGE KIT (3.0L, V6, PETROL ENGINE)

AUDI 正時工具 (3.0L · V6 · 汽油引擎)

- For timing left and right camshafts of petrol engine.
- Include camshaft and crankshaft setting and locking tools, camshaft sprocket adjusting tool and tensioner retaining pins.
- Application: Audi A4 3.0 V6 (2001~2008), Audi A6 3.0 V6 (2001~2008), Audi A8
- Engine code: ASB, AVK, BBJ.
- VW OEM no. ref. : T40028, T40030, T40026, T40011.



H.C.B-A1235

AUDI CAMSHAFT ADJUSTMENT GAUGE KIT (2000~2004) (3.0L V6)

AUDI 正時工具組 (2000~2004) (3.0L V6)

5 / 14.2 / 15.4 / 1.59'

- Used to lock and hold camshafts when adjusting the left and right camshafts.
- Application: 2002-2005 AUDI A4 and 2002-2004 AUDI A6.
- Suited to AVK, AUDI 3.0L V6 5V engine.
- VW OEM no. ref. : T40030.

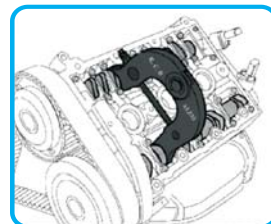

H.C.B-A1054-3 VW T4 CAM BELT PULLEY PULLER

VW T4 正時皮帶盤拔取器

- Use H.C.B-A1054-3 can remove rusting pulley easily, after removing middle screw of pulley.
- Put H.C.B-A1054-3 in the holes of pulley to removes pulley.
- On car maintenance.
- Adjustable legs fit different diameters of pulleys.
- Specification: Diameter ranges from 50 – 95 mm.
- N.W.: 1.718 KGS.



H.C.B-B1054-3 VW T4 CAM BELT PULLEY PULLER ACCESSORIES

VW T4 正時皮帶盤拔取器

- H.C.B-B1054-3 can also be combined with plate of H.C.B-A1054-2 for using.
- N.W.: 0.418 KGS.



H.C.B-A1512 **ON CAR** VW R2/T4/A3 CAM BELT PULLEY PULLER

VW R2/T4/A3 凸輪軸拔卸器 (改良型)

- Put A1512 in the holes of rusting pulley to remove.
- On car maintenance.
- Adjustable legs fit different diameters of pulleys.
- Application:
VW T4 use Six hook.
AUDI A3 use Five hook.
R2 use Six hook

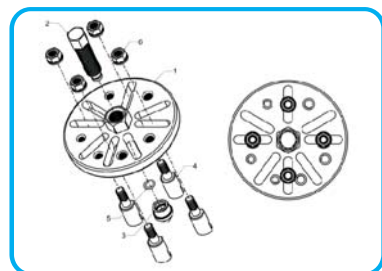

FOUR HOOKS

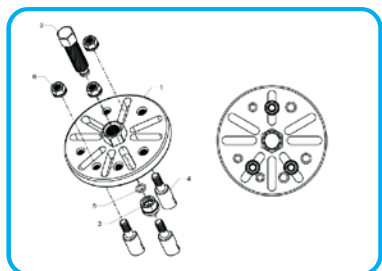

FIVE HOOKS

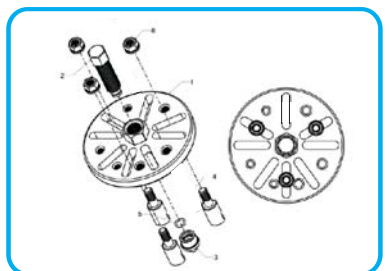

SIX HOOKS



H.C.B-A1295

VW/ AUDI DIESEL INJECTION PUMP WRENCH (13 mm)

VW/ AUDI 柴油噴射泵扳手 (13 mm)

- Single box-end wrench for fixing screws at the injection pump, when replacing the toothed belt.
- Application: 1600 c.c. 4 cylinders diesel engine AUDI 80, VW GOLF, Jetta, Caddy, Passat, Santana, CITROEN BENZ (OM601/ 615/ 616/ 617)
- Chrome-Vanadium Surface chrome-plated.
- S: 13 mm x L: 160 mm
- N.W.: 0.84 KGS.



H.C.B-A2069-T30

Dr. 3/8" x T30 UNIVERSAL JOINT BIT SOCKET

Dr. 3/8" x T30 萬用套筒

H.C.B-A2069-T40

Dr. 3/8" x T40 UNIVERSAL JOINT BIT SOCKET

Dr. 3/8" x T40 萬用套筒

H.C.B-A2069-T45

Dr. 3/8" x T45 UNIVERSAL JOINT BIT SOCKET

Dr. 3/8" x T45 萬用套筒

H.C.B-A2069-T50

Dr. 3/8" x T50 UNIVERSAL JOINT BIT SOCKET

Dr. 3/8" x T50 萬用套筒

- For the operation of screws of the upper door hinge, when aligning or installing and removing the driver's and co-driver's door on VW POLO CLASSIC, POLO VARIANT, CADDY since 1995 consider VW torque regulations.
- With universal joint.
- Drive 10 mm = 3/8".
- Application: For timing belt clamping screw on AUDI 80/ A4 and VW GOLF Mk3 engines.



H.C.B-A1662

NEW

VAG (1.8/2.0 TSI) CAMSHAFT ROTATING ALIGNMENT TOOL

VAG (1.8/2.0 TSI) 凸輪軸轉動正時工具

- Special designed to rotate the camshaft in TDC position.
- Application: VAG 1.8, 2.0 TSI engine.
- VW OEM no. ref.: FVNST9143-A, FVNST9143-B

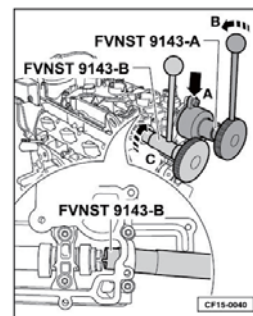

H.C.B-A2069 7 PCS Dr. 3/8" TX-STAR UNIVERSAL JOINT BIT SOCKET KIT (T20, T25, T27, T30, T40, T45, T50)

7 PCS Dr. 3/8" 萬用套筒組 (T20, T25, T27, T30, T40, T45, T50)



TX-STAR

- Universal joint and Dr. 3/8" for A2069, Dr. 1/2" for B2069.
- Use it when the straight shaft bits are not able to access the bolt.
- T45 is a multi-tasked driver.
 - 1) To align and/or install both the driver and passenger doors by way of the door hinge bolts on some VW vehicles.
 - 2) To R&R of the securing bolt on timing belt pretension found on Golf III & Audi 80.
- T50 is used for R&R of the securing bolt of oil pump on most newer popular Mercedes engines.

H.C.B-B2069 8 PCS Dr. 1/2" TX-STAR UNIVERSAL JOINT BIT SOCKET KIT (T30, T40, T45, T50, T55, T60, T70, T80)

8 PCS Dr. 1/2" 萬用套筒組 (T30, T40, T45, T50, T55, T60, T70, T80)



TX-STAR



H.C.B-A2087 VW T4 PROPELLER SHAFT SPECIAL SOCKET (M8/M10/M12/M14)

VW T4 傳動軸特殊長套筒 (M8/M10/M12/M14)

25 | 27 | 28 | 0.52'



- For loosening the screws at the drive shaft quick and easy from outside.
- Impact guns are not allowed.
- Application: VW T4, VW TOUAREG... etc.
- Length: 800 mm.

Item No.	Specifications	Length
A2087-1	M14	800 mm
A2087-2	M12	800 mm
A2087-3	M10	800 mm
A2087-4	M8	800 mm





H.C.B-A1220

VW/ AUDI BELT TENSION PIN WRENCH

VW/ AUDI 皮帶張力調整扳手

- Double-Pin wrench with 3 mm pins spaced 18 mm apart at a 15 degree offset.
- Use to adjust belt tension on 1.9 diesel and 2.0L gas engines 2/98-2003.
- VW Engines: AEG, AVH, AZG, ALH, BDC
- Application: AUDI A3, VW GOLF 3, 1999 or newer TDI, VW BORA 2.0, GOLF 1.6, new BEETLE 1.6. PASSAT 2.0 (2001~2005), BT 1.6, 2.0, GOFA (1999~2005), BR (1998~2005).
- **VW OEM no. ref. :** T10020.



H.C.B-B1220

VW/ AUDI TIMING BELT TENSION ADJUSTER (240 mm)

VW/ AUDI 惰輪正時皮帶張力調整扳手 (240 mm)

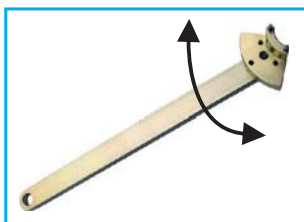

Three angles to adjustable



A4/1.8T, 2.0 1999-2004
A6/1.8T 2002-2004



A3 A4 Golf Passat
2.0 TDI diesel fuel



A4/3.0 After 2002
A6/3.0 After 2002
A8/7.0 After 2003



Golf 88-97 Passat 92-97
VW T4/2.0 1992-2004
VOLKSWAGEN 1992-1997

- With adjustable clamping lever to tense timing belts on VW, Audi engines.
- Due to the adjustable clamping lever, the tensioner puller can be operated even in constricted areas.
- Length: 240 mm
- Application: A4/1.8T, 2.0 1999-2004 A6/ 1.8T 2002-2004, A3 A4 Golf Passat 2.0 TDI diesel fuel, GOLF 88-97 Passat 92-97 VW T4/ 2.0 1992-2004 VOLKSWAGEN 1992-1997, A4/3.0 after 2002, A6/ 3.0 after 2002, A8/ 7.0 after 2003.

H.C.B-C1220

VW/ AUDI BELT TENSIONER ADJUSTMENT WRENCH

VW/ AUDI 惰輪正時皮帶盤調整扳手

- This wrench can adjust the timing belt.
- Application: VW GOLF (2004~2005), JETTA PUNPE DUSE, AUDI 3.0 V6 engines (2002~2005).
- Engine code: ASN, AVK, BBJ.



H.C.B-A1276 AUDI CAMSHAFT ADJUSTING SOCKET (Dr. 3/8")

AUDI 凸輪軸調整套筒 (Dr. 3/8")

- Camshaft adjusting socket used for adjusting variable valve timing on the exhaust side camshaft to basic position.
- Special groove nut socket to turn the camshaft adjuster into position.
- Application: VW, AUDI engine-V6 3.0L 5 valves per Cylinder.
- VW OEM no. ref. : T40028.

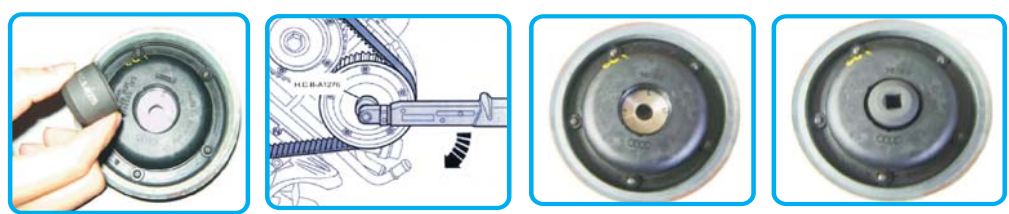

H.C.B-A2108 VW/ AUDI WATER PUMP PULLEY LOCKING WRENCH

VW/ AUDI 水幫浦皮帶盤支撐扳手

- Safe locking of the water-pump pulley.
- Allows easy loosening of stubborn bolts on the water-pump pulley.
- Overall length: 298 mm
- Width: 65 mm
- Application: VW/ AUDI.



H.C.B-A2109 VW/ AUDI WATER PUMP PULLEY LOCKING WRENCH

VW/ AUDI 水幫浦皮帶盤支撐扳手

- The Dr. 1/2" in the handle enables an extension if combined with a ratchet.
- Allows easy loosening of stubborn bolts on the water-pump pulley.
- Overall length: 250 mm.
- Width: 80 mm.
- Application: VW/ AUDI.

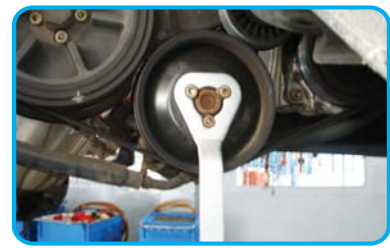



H.C.B-A2154 & A2090

BENZ (M271), VW/ AUDI V-BELT PULLEY REMOVER/ INSTALLER (Dr. 1/2", M10)

BENZ (M271), VW/ AUDI 發電機皮帶盤拆裝器 (Dr. 1/2", M10)

- The tool is used to remove/install the free-wheel pulley of VW and AUDI .
- Use with 17 mm wrench and H.C.B-A2090 (M10) to remove/ install the socket.
- Application: BENZ (M271), VW GOLF, VENTO, PASSAT, AUDI A3 and VOLVO. VW JETTA with 1.9 liter TDI engines.

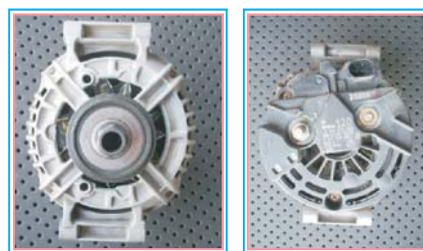

A 271 154 0802



H.C.B-A2181

VW/ AUDI IMPACT SOCKET (Dr. 3/4", M18, 105 mm)

VW/ AUDI 後仰角傳動軸套筒 (Dr. 3/4", M18, 105 mm)

- Specially designed for fixing the screw of rear wheel axles.
- Impact quality, M18 XZN/ Spline hub bolt socket used to remove and install high torque hub bolts on VAG models.
- Dr. 3/4" is essential to accommodate torque loadings as high as 200 Nm.
- Application: AUDI A3, Seat: Altea, Leon, Toledo, VW: Golf, Golf Plus, Jetta, Touran, Eos, Passat



H.C.B-B2181

VW/ AUDI IMPACT SOCKET (Dr. 1/2", M18, 78 mm)

VW/ AUDI 後仰角傳動軸套筒 (Dr. 1/2", M18, 78 mm)

- Specially designed for fixing the screw of rear wheel axles.
- Application: VW/ AUDI.



H.C.B-A1307 VW/ AUDI SPECIAL WRENCH (V6, TDI, TURBO)

VW/ AUDI 特殊扳手 (V6, TDI, TURBO)

- Dr. 3/8" , 12 mm, 12 points.
- The special wrench for turbo.
- Special wrench for the screw below the turbo-charger of diesel engines of VW/ AUDI
- New model, short type screwer make itself more user-friendly.
- Application: VW/ AUDI V6 TDI Disel engine.



H.C.B-A1342 VW/ AUDI BELT PULLEY HOLDER

VW/ AUDI 皮帶盤支撐器

- Special design for counter-hold crankshaft toothed belt chain when installing crankshaft oil seal (belt pulley end).
- Application: VW: Lupo/ Polo (Classic) / Golf/ Bora/ Caddy.
AUDI: A2.

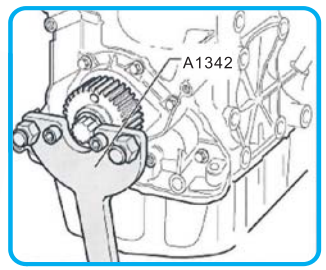

H.C.B-A1321 VW HARMONIC DAMPER REMOVER

VW 正時皮帶盤拆卸器

- While removing the harmonic damper, this tool is for holding the crankshaft pulley.
- Time saving and no damage to the harmonic damper.
- Application: VW 5 cylinder engine with poly-V-belt. Such as VW T4/ VW LT.



H.C.B-A1322 VW/ AUDI CRANKSHAFT PULLEY REMOVER

VW/ AUDI 正時皮帶盤拆卸器

- For removing the front pulley from the crankshaft.
- Application: VW/ AUDI 4 and 5 cylinder engines.

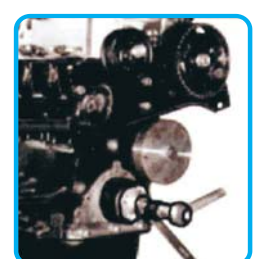



H.C.B-A1323

VW/ AUDI VIBRATION DAMPER LOCKING TOOL

VW/ AUDI 正時皮帶盤支撐器

- For locking the vibration damper (crankshaft pulley) when changing the crankshaft-center bolt.
- Application: VW engine. Such as T4 van with 5 cylinder diesel.
- VW OEM no. ref.: 3273.



H.C.B-A1324

VW/ AUDI VIBRATION DAMPER LOCKING TOOL

VW/ AUDI 正時皮帶盤支撐器

- For holding the V-belt pulley or vibrator damper when changing the timing belt.
- Application: VW/ AUDI 5 cylinder diesel engine (after year 1997). Such as ATT, ABP, AEL...etc.
- VW OEM no. ref.: 3256.

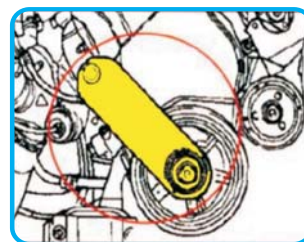

H.C.B-A1325

VW/ AUDI BELT TENSION ADJUSTER

VW/ AUDI 惰輪調整器

- Dr. 1/2".
- For tensioning multi-vee belts.
- Special designed milled pins for not slipping out of the holes in the alternator.
- Application: VW/ AUDI engines with the multi-vee belts can only be tightened at the alternator.



H.C.B-A1343

VW/ AUDI DIFFERENTIAL FILTER SPANNER

VW/ AUDI 差速器濾芯扳手

- Size: 46 mm X 12 PT & 5 mm hex key.
- Application: AUDI: TT/ A3/ A4/ A6/ A8.
VW: Passat/ Touareg/ Bora/ Golf/ Sharan/ Skoda-Octavia.
- For detaching & tightening the oil filters of the haldex clutch.
- VW OEM no. ref.: T10066

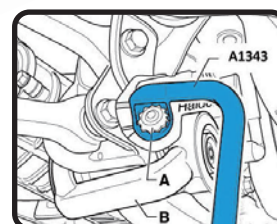
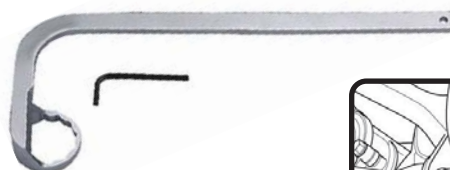



010
HWANG CHERNG BIN
 Specialty Tools Inc.

福斯修護工具
VW Repair Tool

H.C.B-A1348 **VW/ AUDI OIL FILTER WRENCH (Dr. 1/2", H= 22 mm, D= 42 mm)**

VW/ AUDI 機油芯扳手 (Dr. 1/2", H=22 mm, D=42 mm)

- For removing oil filter with special adapter.
- Application: VW/ AUDI diesel engine with MANN- Mahle-, Knecht filters.
- Dr. 1/2", H: 22 mm, D: 42 mm.



H.C.B-A2137 **4 PCS VW/ AUDI IGNITION COIL PULLER**

VW/ AUDI 直接點火線圈拔取器組 (4 PCS)

10 / 9.5 / 10.5 / 1.1'

- The kit is for Volkswagen and Audi vehicles fitted with direct ignition engines.

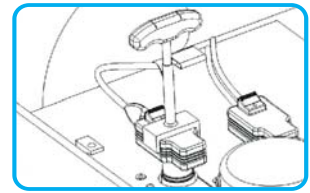

Parts No.	Application	Parts No.	Application
1	VW, Bora, Golf, Passat, Sharan, Touareg, Phaeton and T5 · V5 2.3, V6 3.2, Transporter T5 6-Cylinder with injection engine(2004-).	3	VW, Bora, Golf, New Beetle, Passat, Polo, Touran 1.4 / 1.6 L, Lupo 4-Cylinder FSI, Phaeton and Transporter T4, BBY. BKY 1.4.
2	VW 8- and 12-Cylinder engines. e.g. Phaeton, B5 1.8T, GTI, FSI 2.0.	4	VW 8- and 12-Cylinder

H.C.B-A2201 **VW/ AUDI (A4/A6/A8/A11) GAS / DIESEL ENGINE TIMING TOOL KIT**

VW/ AUDI(A4/A6/A8/A11) 汽 / 柴油引擎正時工具組

5 / 21.5 / 22 / 2'

- This kit is required for petrol & diesel engine service.
- For timing belt replacement on recent models and also older 1.9d models from 1976.
- Models: AUDI A4, A6, A8, A11 YOAD (97-04), VW PASSAT (98-04).



H.C.B-A2211 **VW/ AUDI AIRBAG REMOVAL TOOL KIT (12 PCS)**

VW/ AUDI 安全氣囊拆除工具組 (12 PCS)

20 / 16 / 17 / 2'

- Suitable for the fast and safe removal of steering wheel airbags.

Application:

Audi /Volkswagen/Skoda/Seat/Vauxhall/Opel /BMW/Mercedes-Benz.
 VW PASSAT B5/POLO/LUPO, AUDI A4 AND A6, SKODA SUPER B.
 VW GOLF 4, NEW BEETLE, SEAT, SKODA FABIA, OKTAVIA AB BJ.99.
 VW GOLF 4 (BJ.1998-2004),VW-PASSAT AB BJ.1997, BORA BA BJ.1999.
 VW PASSAT AB BJ.2000.

- T30 FOR AUDI, OPEL, RENAULT, VW
- T30 TAMPER, FOR AUDI, BMW, BERCEDES, OPEL
- T25 FOR BMW
- T25 TAMPER, FOR BMW
- 5 MM HEXAGON, FOR AUDI



VW Repair Tool





H.C.B-A2207

VW/AUDI DIESEL TDI PD ENGINE TIMING TOOL KIT

VW/ AUDI 柴油 TDI PD 引擎正時工具

- Application: Audi A2 1.4 TDi PD (02-06), A3 1.9, 2.0 TDi PD (02-08), A4 1.2 TDi PD (02-05), A4 1.9, 2.0 TDi PD (04-08), A6 1.9 TDi PD (02-05), Seat; Altea 1.9 SDi/ TDi (05-08), Leon 1.9, 2.0 TDi PD (05-08), Toledo 1.9 SDi/ TDi (05-08), Skoda; Fabia 1.4 TDi PD (03-06), Octavia II 2.0 TDi PD (03-06), VW; Beetle 1.9 TDi PD (02-08), Bora 1.9 TDi PD (02-08), Fox 1.4 TDi PD (02-08), GOLF 1.9 TDi PD (02-08), Lupo 1.4 TDi PD (02-08), Polo 1.4, 1.9 TDi PD (02-08), Sharan 1.9 TDi PD (02-08).



- VW OEM no. ref.:
T10050, T10100, T20102,
T10060/A, T10115

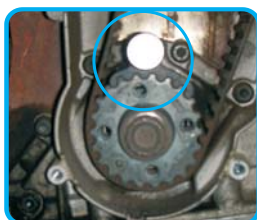

A2207-1 Crankshaft Setting Tool- Non bored engine



A2207-2 Crankshaft Setting Tool



A2207-3 Locking Pin

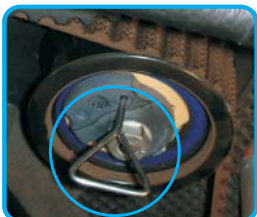

A2207-4 Tensioner Pulley Locking Pin



A2207-5 Injection Pump Locking Pin



A2207-6 Injection Pump Locking Pin & 4

H.C.B-A1364

VW/ AUDI REAR AXLE BUSHING TOOL

VW/ AUDI 鐵套拆卸器

10 / 23 / 24 / 1.2'

- Special design for replacing the rear axle mounting bushes without the need of removing the rear axle assembly.
- Its fine thread and thrust bearing allow the bush to be fitted quickly and easily without causing damage.
- Application: AUDI A3/ VW GOLF/ BORA 1.4/ 1.6/ 1.8/ 2.0/ 1.9d (2001~2003).



H.C.B-C1357 VW/ AUDI (TDI)/ BMW N47/ N57 DIESEL INJECTOR REMOVER

VW, AUDI (TDI)/BMW N47/N57 柴油噴油嘴拆卸器

- Used when removing injector unit from cylinder head.
- Special design for removing the seized diesel injector from VAG TDi engines.
- Always cool down the engine before using this tool.
- Special two jaws design to fix the injector and pull out with slide hammer.
- Application: VW, AUDI TDi engine code: ALH/AHU/1Z , VW T5 1900 c.c. (No.6), 2500 c.c. (No.6), 2000 c.c.(No.7), BMW (N47) (N57)
Golf 2009 >4-cyl. diesel engine (1.6l engine, common rail) (No.11) Golf 2009> with 2.0 liter TDI common rail engine and on Audi A3 2013> with 2.0 liter TDI common rail engine.
- VW OEM no. ref.: T10055/ T10163/ T40055/ T10402/ T10415.



	Description	Application	VW OEM no.
1	Slide hammer Puller		T10055
2	Direct overhead grip		T10163
3	Adaptor		
4	Adaptor		
5	Adaptor		
6	Adaptor	VW T5 1900 c.c., 2500 c.c.	
7	Adaptor	VW T5 2000 c.c. BMW N57	M14 x P1.5, M8 xP1.25
8	Adaptor	VW,AUDI PETROL INJECTORS(Golf)	
9	Blow mold case		
10	Adaptor	VW SPECIAL SOCKET	T40055
11	Adaptor	VW 1600 c.c.	T10402
12	Adaptor	VW 2000 c.c	T10415

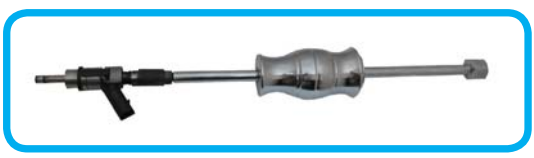
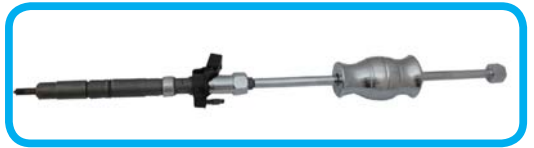
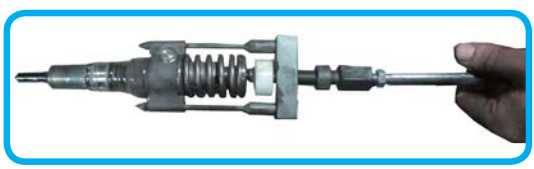
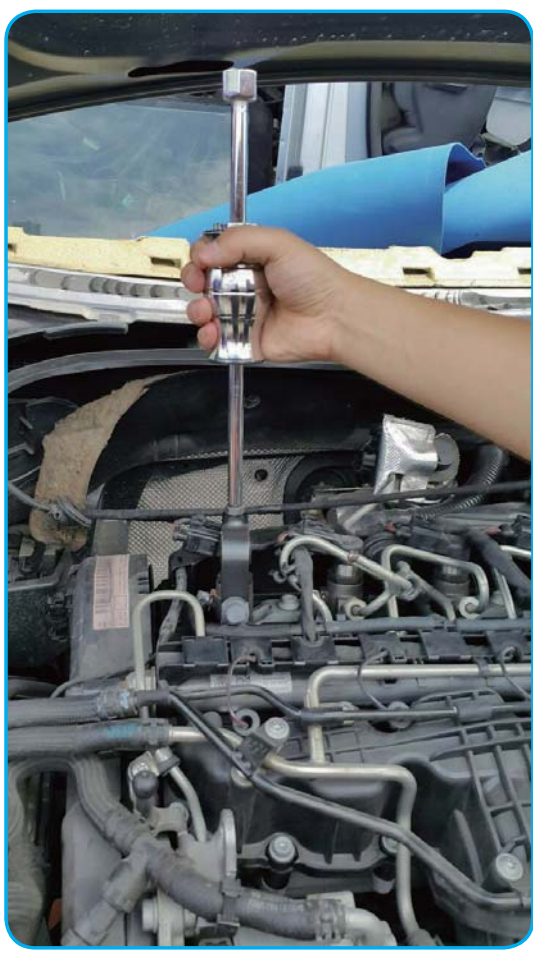



H.C.B-B1357

VW/ AUDI (TDI)/ BMW N47/ N57 DIESEL INJECTOR REMOVER

VW/ AUDI (TDI), BMW N47/N57 柴油噴油嘴拆卸器



- Used when removing injector unit from cylinder head.
- Special design for removing the seized diesel injector from VAG TDi engines.
- Always cool down the engine before using this tool.
- Special two jaws design to fix the injector and pull out with slide hammer.
- Application: VW/ AUDI TDi engine code: ALH/AHU/1Z , VW T5 1900 c.c. (No.6), 2500 c.c. (No.6), 2000 c.c. (No.7), BMW (N47).
- **VW OEM no.ref.:** T10055/ T10163

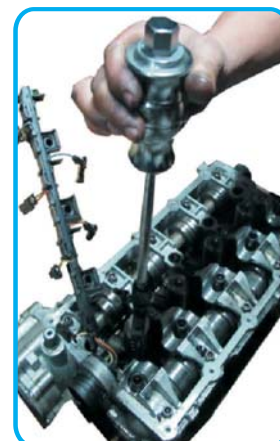

H.C.B-A1357

VW/ AUDI (TDI) DIESEL INJECTOR REMOVER

VW/ AUDI (TDI) 柴油噴油嘴拆卸器

- Special design for removing the seized diesel injector from VAG TDi engines.
- Always cool down the engine before using this tool.
- Special two jaws design to fix the injector and pull out with slide hammer.
- Application: VW/ AUDI TDi engine code: ALH/ AHU/ 1Z

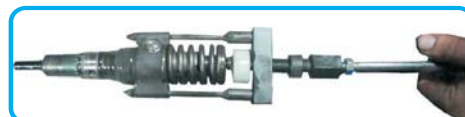
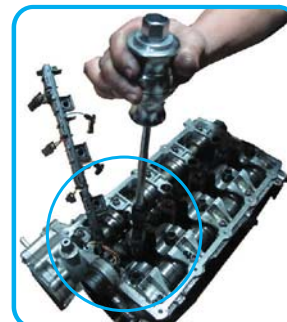

H.C.B-A1368 VW POLO BUSH REMOVER/ INSTALLER

VW POLO 鐵套拆裝工具組



Removal



Installation

- Suitable for VW Polo (9N) front-axle bracket wishbone bushes.
- For easy removal and insertion of the rear bush on the front track control arm VW polo.
- Advantage: Removal of the aggregates carrier unit is not necessary!
- Application: VW Polo 9N, Audi A2, Skoda Fabia, Seat Cordoba, Seat Altea....

H.C.B-A1372 VW DIESEL INJECTOR PUMP TEST GAUGE KITS

VW 柴油噴油嘴幫浦測試錶組

- Used for setting the timing of diesel injection pumps.
- Applicable to VW and AUDI diesel models through 1997.



H.C.B-A1373 VW/ AUDI FSI 2.0 L / TURBO TIMING TOOL

VW/ AUDI FSI 2.0L / TURBO 正時工具

- To set the timing and adjust camshaft of FSI and TFSI 2.0L engine.
- Application: AUDI A3/ A4, AUDI TT/ Golf/ Jetta/ Passat, SKODA. Year 2004~2009.
- Engine codes: AWA, BMB, AXW.
- VW OEM no. ref. : T10252, T10020, T40011, T10115, T10092, T10060A, T40080, 3366.

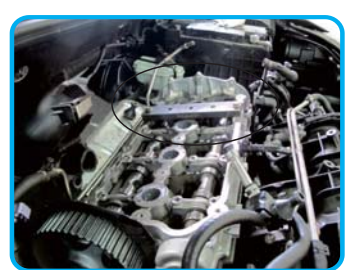

H.C.B-A1386 AUDI ENGINE OIL LEVEL GAUGE

AUDI 機油尺

200 / 6.2 / 7.2 / 1.2'

- The tool is designed for measuring the oil level of engine.
- Application : 2009 and Newer Audi A4, A5 and A6 with a 2.0L TFSI, 3.2L FSI, 4.2L FSI and 2010 S4 3.0L Supercharged engine.
- Minimum engine oil temperature 140° F (60° C).
- Vehicle must be in level position.
- After stopping engine, wait a few minutes to allow oil to flow back into oil pan marking field on the dipstick.
- Adjust the value on the A1386 on the upper scale (see arrows) by loosening the knurled screw & moving the adjusting ring to the position shown on the picture above. Tighten knurled screw.
- Insert the oil level dipstick A1386 into the oil dipstick tube until adjusting ring stops at the top of the tube.
- Read the value on the scale at the end of the dipstick.

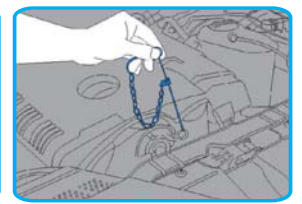



H.C.B-B2224

VW CAMSHAFT DRIVE BELT PULLER

VW 凸輪軸皮帶盤拔卸器

- Puller used to remove cam sprockets.
- Includes 18 mm, 23 mm and 25 mm pulling arms.
- Application: VW 4 cylinder TDI, VW/ Audi V6 (5V) and Audi V8 (40V). Also includes both arms for 2.0L 4V Direct Injection Engines (BPY) (BPG) (BWT).
- VW OEM no. ref.: T40001.

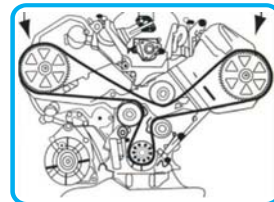

H.C.B-A2070

VW/ AUDI TRANSMISSION/ GEARBOX SOCKET (Dr. 1/2", M16)

VW/ AUDI 變速箱 / 齒輪箱套筒 (Dr.1/2", M16)

- For removing and replacing the tamper proof plug on transmission and gearbox of VW/ AUDI vehicles.
- Application: AUDI A3/ A4/ A6 and GOLF IV/ LT.
- N.W.: 0.38 KGS.



Dr. 1/2" x M16



H.C.B-B2070

VW/ AUDI TRANSMISSION/ GEARBOX SOCKET (Dr. 1/2", M18)

VW/ AUDI 變速箱 / 齒輪箱套筒 (Dr. 1/2", M18)

- Size: XZN M18 in 1/2" head, length 78 mm.
- Special head designed for screws on VW half-axes.

Dr.1/2"



Dr. 1/2"xM18

H.C.B-C2070

VW/ AUDI TRANSMISSION/GEARBOX SOCKET (Dr. 1/2" , M16)

VW/ AUDI 變速箱 / 齒輪箱套筒 (Dr. 1/2", M16)

- For removing and replacing the tamper proof plug on transmission/ gearbox of VW and AUDI vehicles
- Application: AUDI A3/ A4/ A6 and GOLF IV/ LT.



Dr. 1/2" X M16



H.C.B-A2085 VW T4 TRANSPORTERS MULTI-SPLINE SOCKET (Dr. 1/2" , M14)

VW T4 輸送機上球頭拆卸套筒 (Dr. 1/2" , M14)

200 / 24 / 25.5 / 1.6'

- For removing the upper ball-joint on VW T4 transporters.
- Length: 60 mm
- Drive: 1/2"



H.C.B-B1475 VW SPECIAL SOCKET (Dr. 3/8" x 17 mm x 78 mm L)

VW 柴油噴油嘴高壓管特殊套筒 (Dr. 3/8" x 17 mm x 78 mm 長)

- Material: CR-V with silver chrome plating, matt finish.
- Universally suitable for the coupling nut of the high pressure line on VW-Audi, Seat, Skoda common-rail diesel engines.
For example: VW Polo (6R); Golf (1K) (5K, AJ); Passat (3C); Audi A1 (8X); A3 (8P); A4 (8K), A6 (4F); A8 (4E); Seat Ibiza (6J); Leon (1P); Skoda: Fabia II (54); Octavia II (1Z)
- Specially cut-socket (17 mm) for quick and easy loosening and tightening the union nut at high pressure lines of common rail diesel engines.
- VW OEM no. ref.: T40055.



H.C.B-B2155-24 VW SPECIAL SOCKET (12 POINT , SW 24 mm)

VW 特殊套筒 (12 角 , SW 24 mm)



- For VW GOLF (VI,VII), Scirocco, Tiguan, Touran, Passat(3C), Passat CC, Audi A3, TT; Seat Leon, Altea, Skoda Octavia(1Z), Super B(3T) etc....



H.C.B-E1413

VW 1.2 TSI TIMING TOOL KIT

VW 1.2 TSI 正時工具組

- Camshafts locking tools suitable for VW 1.2 TSI.
- Application:

Brand	Model	Engine
VW	Polo, Caddy, Caddy Maxi, GOLF, GOLF plus, GOLF estate, Touran, Jetta, GOLF VI cabrio	1.2 TSi
AUDI	A1, A3, A3vabrio	1.2 TSi

- Engine code: CBZA, CBZC, CBZB
- VW OEM no. ref.: T10414/ T10340.

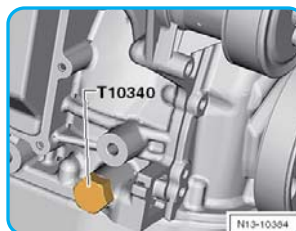

H.C.B-F1413

VAG TFSI/FSI ENGINE TIMING TOOL KIT

VAG TFSI/FSI 引擎正時工具組

- Application: Audi A1 ('10-), Audi A3 ('04-)
- Engine Codes: 1.2TSI - CBZA, CBZB; 1.4T/FSI - CAXA, CAXC, CAVG; 1.6FSI - BAG, BLP, BLF
- VW OEM no. ref.: T10414/ T10340/ T10341/ VAS6079/ T10170/ T10171(A)/ T20046(T40011)



H.C.B-G1413

VAG 1.2 TFSI/TSI PETROL ENGINES CHAIN ENGINE LOCKING TIMING TOOL KIT

VAG 1.2 TFSI/TSI 汽油引擎鏈條固定正時工具組

- This kit is for the generation of VAG 1.2 TSI and 1.2 TFSI engines were first introduced in 2009 and are available in vehicles across the four main brands of the VAG Group (Audi, Seat, Skoda and Volkswagen.) These four cylinders, single camshaft engines, have two valves per cylinder. A timing chain provides drive between the crankshaft and camshaft. The engines are turbo charged and use a high pressure direct injection fuel system.

- Content :

	Description	VW OEM no. ref.
1	Camshaft Setting Tool	T10414
2	Crankshaft Locking Pin	T10340
3	Timing Cover Alignment Pins (2)	T10341

- Application: Audi: A1, A3, A3 Sportback, A3 Cabriolet
Seat: Altea, Altea XL, Ibiza V, Ibiza Sportcoupe, Leon, Toledo IV
Skoda: Fabia II, Fabia Combi, Rapid, Oktavia II, Oktavia Combi, Rommster, Yeti
Volkswagen: Beetle, Caddy III, Golf VI, Golf Plus, Golf Cabriolet, Golf Variant, Jetta IV, Polo, Touran.
- Engine Codes: CBZA/ CBZB/ CBZC



H.C.B-D1413 VW/ AUDI GROUR FSI (VAG) VALVE TIMING TOOL KIT

VW/ AUDI GROUR FSI (VAG) 閥門正時工具組

- A comprehensive set containing the necessary tools to service FSI engines fitted to Volkswagen Polo, Golf Touran, Passat; Skoda Octavia and Audi A3 with 1.4/1.6 engines (Codes AXW, AXU, BAG, BLF, BKG, BLN, BLP).
- Audi A3, A4, A6, Volkswagen Golf, Passat and Touran with 2.0 engines (Codes AXW, BHD, BMB, AWA, AXX, BPY, BWA).
- Audi A6, A6 Quattro with 2.4 engines (Code BDW), Audi A4, A6, A8 with 3.2 engines (Codes: AUK, BKH).
- Plus TFSI 2.0 engines fitted to Audi A4, A6 and Volkswagen Passat (Codes BUL, BPJ, BGB, BWA, BWE).

Comprehensive tool kit for changing the cam belt or chain on many VAG engines. Suitable for petrol and diesel engines, including the latest applications for Fsi and TFSi engines.

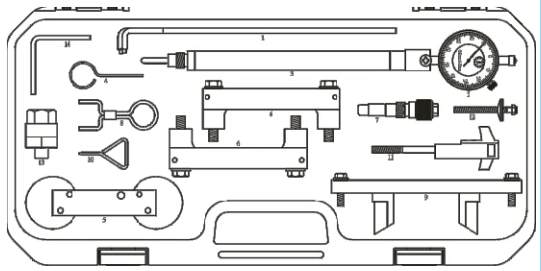

Layout ID	Item no	Description	VW OEM no. ref.
1	A1220	Toothed Belt Tensioner	T10020
2	B1416-5	Dial gauge	VAS6079
3	B1413-2	Dial Gauge Adapter	T10170
4	B1413-4	Locking Pin	T40011
5	A1413-1	Camshaft Lock	T10171
6	C1413-1	Camshaft Clamp (2 pcs/ 1set)	T40070
7	A1105-6	Crankshaft Locking Pin	T40069
8	C1413-2	Locking Pin	T40071
9	A1373-1	Camshaft Clamp	T10252
10	A1373-4	Locking Pin	T10115
11	A1214	Bracket For Chain Adjustment	3366
12	A1373-5	Tensioning Bolt	T10092
13	A1425	Crankshaft Socket	T40058
14	A2207-3	Locking Pin	T10060/A
15		Blow Mould Case	

■ Operating Instruction

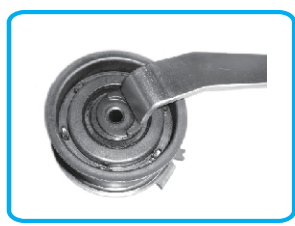

Use No.1

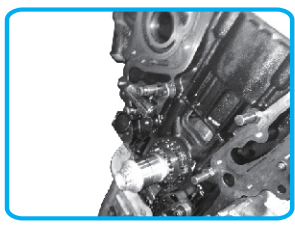

Use No.4

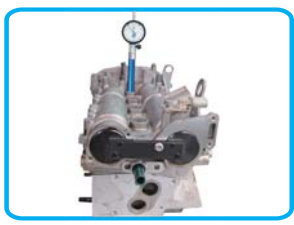

Use No.3&5

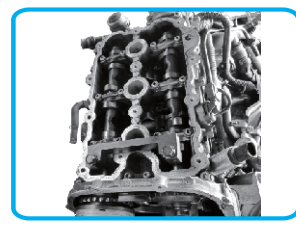

Use No.6

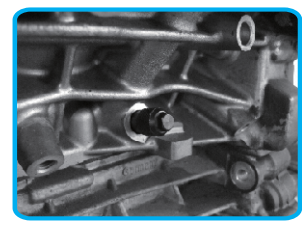

Use No.7

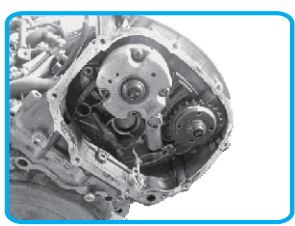

Use No.8

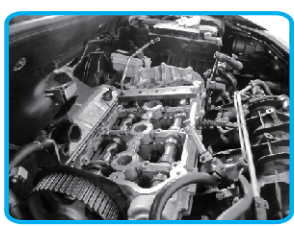

Use No.9

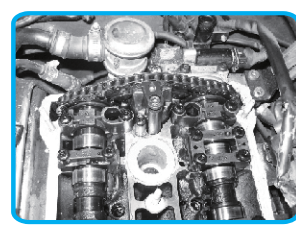

Use No.11

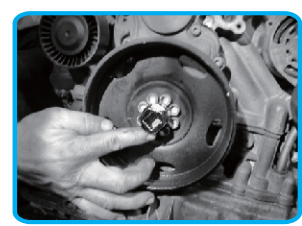

Use No.13



H.C.B-C1413

AUDI A4/A6/A8 (2.4/3.2 FSI) CHAIN ENGINES TIMING TOOL KIT

AUDI A4/A6/A8(2.4/3.2 FSI) 鏈條正時工具組

- Used for the latest Audi with FSI chain driven engine.
- Application: Audi A6 2.4, Audi A4, A6, A8 .A10 3.2 Fsi.
- Engine Codes: AUK, BDW, BGP, BGQ, BKH, BPK, BYU, BVJ, BNS, BYH, CAUA, BXA und BSM

Kit Specification & Application

Layout ID	Item no	Description	AUDI OEM no. ref.
1	C1413-1	Camshaft locking Tools (2 pcs)	T40070
2	C1413-2	Locking Pin	T40071
3	A1105-6	Crank Locking timing pin	T40069
4	A1425	Crankshaft turning socket	T40058



Operating Instructions

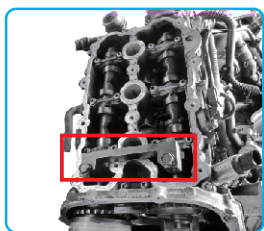

C1413-1

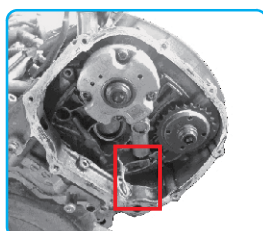

C1413-2

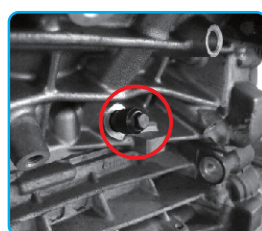

C1413-3(A1105-6)

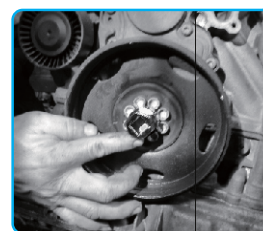

C1413-4(A1425)

H.C.B-B1413

VW/ AUDI PETROL ENGINE TIMING TOOL KIT (WITH GAUGE) (1.4, 1.6 FSI)

VW/ AUDI 正時工具組 (附錶) (1.4, 1.6 FSI)

- For installing and removing the camshaft/ variable camshaft to check and adjust the camshaft for timing.
- Application: Audi; A3 (03-10), Seat; Altea, Ibiza, Leon, Skoda; Fabia II (07-09), Octavia (04-09), Roomster (06-09), Superb (09-10), VW; Eos (06-09), Golf (03-09), Golf Plus (05-09), Jetta (06-09), Passat (05-09), Polo (02-08), Scirocco (09-10), Tiguan (07-09), Touran (03-09).
- Engine: 1.4FSi (AXU, BKG, BLN) · 1.4TFSi (BLG, BMY, BWK, CAVA, CAVB, CAVC,CAVD, CAVF, CAXA, CAXC, CDGA) · 1.6FSi (BAG, BLF, BLP, BTS)

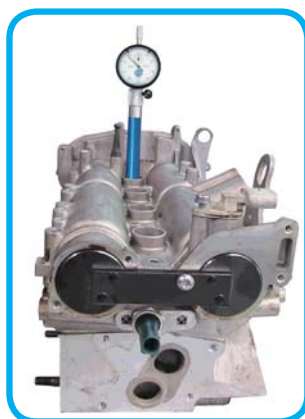
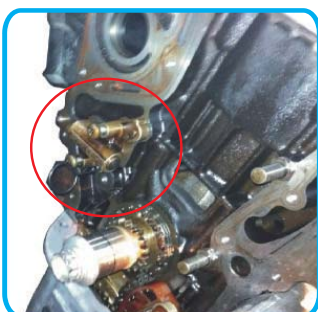

H.C.B-A1413

VW/ AUDI PETROL ENGINE TIMING TOOL KIT (1.4, 1.6 FSI)

VW/ AUDI 正時工具組 (1.4, 1.6 FSI)

- For installing and removing the camshaft/ variable camshaft to check and adjust the camshaft for timing.
- Application:
Audi; A3 (03-07), Skoda; Octavia (04-08), VW; Polo (02-08), GOLF (03-08), GOLF Plus (05-08), Jetta (06-08), Passat (05-08), Touran (03-07).
- Engine: AXU, BKG, BLN, BAG, BLF, BLP, BTS.
- VW OEM no.ref.: T10170, T10171, T40011, T10340.

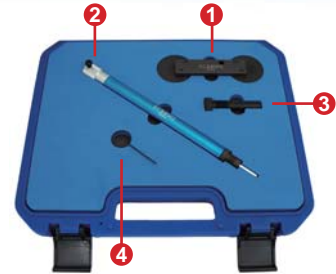

H.C.B-A1414

VW/ AUDI VALVE SPRING COMPRESSOR

VW/ AUDI 汽門彈簧拆卸工具

- This tool is used for removing valve springs.
- Application: 4 cylinder 1.8 L Turbo (5V) AUDI A4 and PASSAT B5 engines.
- VW OEM no. ref.: 3362.

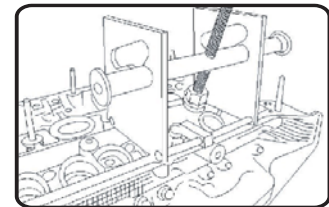

H.C.B-A1565

WATER PUMP REMOVAL TOOL KIT - VW T5 & TOUAREG 2.5D

水泵浦拆卸器組 -VW T5 & TOUAREG 2.5D

- Suitable for removing the water pump on pompe duse, diesel, gear drive engines.
- Essential to align the engine in the TDC position and removal of the water pump.
- This tool is designed for 2.5 liter gear driven engines found in the Volkswagen range.
- This tool is ideal to use in conjunction with B1419.
- Application:
Volkswagen: VW 2.5 TDI PD - T5, Touareg, Transporter (03-09), VW 1.6 - Bora / Golf / Lupo / Polo.
- Engine: AXD, AXE, BAC, BLJ, BLK, BNZ, BPC, BPD
Engine codes: BAC, BLK ONLY.
Loosening the exhaust pipe and starter catalytic converter from the turbo charger and gearbox. (The catalytic converter can stay in place).
Engine codes: BPD, BPE ONLY.
Removing exhaust gas recirculation cooler and particulate filter.
- VW OEM no. ref.: T10225/ T10221A/ T10222A.

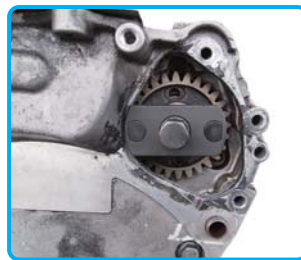



H.C.B-B1419

VW TRANSPORTER T5 AND TOUAREG DIESEL TIMING TOOL KIT (2.5/4.9D/TDI PD)

VW TRANSPORTER T5 AND TOUAREG 柴油引擎正時工具組 (2.5/4.9D/TDI PD)

- Designed for gear driven engines where the injection timing is controlled by the camshaft followers.
- For locking camshafts when checking and adjusting timing.
- For removing and installing camshaft drive gear and eliminating play in gear train.
- For rotating the crankshaft and for locking or positioning of the camshaft and crankshaft as well as for biasing and locking the wheels drive when setting the timing.
- Application: VW 2.5 TDI with pump-jet diesel engines. Built at VW Transporter T5 and Touareg.
- Engine code: BAC, BLK, BPD, AXD, AXE, BLJ, BNZ, BPC (05-09) and 4.9D/ TDI PD models with engine code: AYH ,BKW, BLE,BWF(03-09).



Parts No.	Description	VW OEM no. ref.
A1419-1	Camshaft Clamp	T10193
A1419-2	Camshaft Clamp	T10194
A1419-3	Camshaft Gear Retaining Tool (Type 1)	T10199
A1419-4	Camshaft Gear Retaining Tool (Type 2)	T10199/1
A1419-5	Camshaft Compensation Gear Pre-tensing Tool	T10234
A1419-6	Crankshaft Turning Tool	T10226
A1419-7	Crankshaft Locking Tool	T10225
B1419-8	Screwdriver bit XZN-M16, Length :75mm	
B1419-9	Screwdriver bit XZN-M8, Length :100mm	
B1419-10	Screwdriver bit XZN-M10, Length :100mm	
B1419-11	Screwdriver bit XZN-M14, Length :140mm	





010
HWANG CHERNG BIN
 Specialty Tools Inc.

福斯修護工具
VW Repair Tool

VW Repair Tool

H.C.B-A1425 **VW/ AUDI CRANKSHAFT TURNING SOCKET**

VW/ AUDI 曲軸旋轉套筒

- Used for turning the crankshaft pulley.
- With Dr.1/2", 22 mm square, and 12 mm rotating pivot pin.
- Application: Audi A6 2005 and up, Audi A8 2003 and up.
- Engine : 6 cylinder 2.4, 3.2L FSI.
- **VW OEM no. ref.:**T40058.

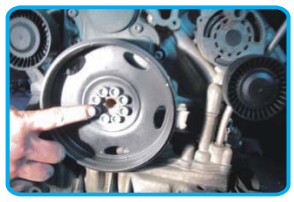

H.C.B-A1429 **VW FUEL TANK WRENCH**

VW 汽油浮筒拆裝器

- For removing and installing the sealing ring on the fuel tank sender flange.
- Application: VW, AUDI A8, VW Touareg 2003, VW Touran 2004, PASSAT 2006, PASSAT CC2009, ESO 2006, Tiguan 2008, GOLF Plus 2005, GOLF 2004.
- **VW OEM no. ref.:** T10202.

Dr.1/2"

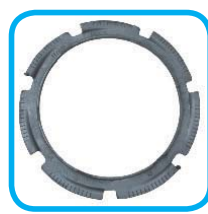

H.C.B-A1642 **NEW** **VW / AUDI CAMSHAFT TIMING CHAIN TOOL KIT (4.2 L)**

VW/AUDI 凸輪軸正時鍊條工具組 (4.2 L)

- For locking camshafts when checking valve timing
- Specially designed to hold and align the camshaft.
- Specially designed to install Hall sender screens into crankshaft adjuster when setting the crankshaft timing.
- Engine Model V8 BAT 4.2 engines.
- Application: Audi A6L, A8L 4.2 engines.
- Engine model: 6-cyl. injection engine (4-valve), 8-cyl. injection engine (W8), 12-cyl. injection engine (W12).
- Golf 1998-newer, Bora 1999-newer, Passat 1997-newer, Sharan 1996-newer, Touareg 2003-newer, Phaeton 2003-newer, Transporter 1991-newer, Audi A8 1994-newer, Audi TT 1999-newer.
- **VW OEM no.ref.:** T40046, T40047. T10068A.



Layout no.	Item no.	Description	OEM no.ref.	remark
1	A1430	AUDI SETTING GAUGE	T40047	2 PCS
2	A1431	VW/AUDI CAMSHAFT BAR	T10068A	2 PCS
3	A1471	VW/AUDI ENGINE TIMING TOOL KIT (TFSI)	T40046	2 PCS
4		Blow Mould Case W/EVA		



H.C.B-A1430

AUDI FIXING GAUGE

AUDI 固定座

- Used to fix camshaft sensor rotor ring in position when installing camshaft timing chains.
- Application: A4 2001 and newer, A6 1998 and newer on 8-cyl engine.
- **VW OEM no. ref.:** T40047

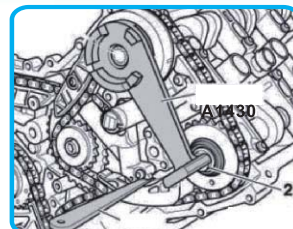

H.C.B-A1431

VW/AUDI CAMSHAFT BAR

VW/AUDI 固定條

- Used to lock camshaft when removing and installing camshafts.
- Application: Golf 1998, Bora 1999, Passat 1997, Sharan 1996, Touareg 2003, Phaeton 2003, Transporter 1991, Audi A8 1994, Audi TT 1999 –.
- Engine Model: 6-cyl. injection engine (4-valve), 8-cyl. injection engine (W8), 12-cyl. injection engine (W12).
- **VW OEM no. ref.:** T10068A.

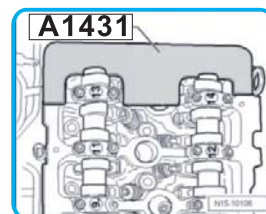

H.C.B-A1471

VW/AUDI ENGINE TIMING TOOL KIT (TFSI)

VW/AUDI 正時工具組 (TFSI)

- For securing camshafts when adjusting timing.
- Application: AUDI A6 2005~Q5 2.0 T, A6L 3.0T.
- Engine model: 6-cyl petrol direct injection 2.8L 4V engine, Mechanics.
- **VW OEM no. ref.:** T40133.



H.C.B-A2232

SHOCK ABSORBER RAM DISMANTLE SOCKET KIT

避震器油壓缸拆裝套筒組

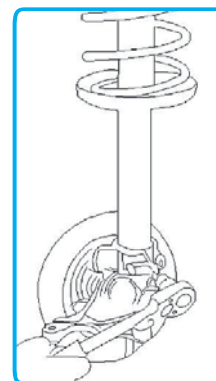

- It is quick and easy to remove and replace the strut unit in the front axle. With this tool, it can reduce the risk of damaging the front axle when removing strut spring.
- Application: VW Golf IV, Audi TT, VW-Audi, BMW, Citroën, Ford, SKODA, Seat, Renault, Peugeot, Japanese cars, etc.

H.C.B-A1470

VW/ AUDI CAMSHAFT ALIGNMENT TOOL (4.2)

VW/ AUDI 凸輪軸正時工具 (4.2)

- Used for locking camshafts when checking valve timing.
- Application: AUDI A42001> AUDI A6 1998> with 8-cylinder engines.
- **VW OEM no. ref. :** T40046.



H.C.B-A1473

VW/ AUDI CAMSHAFT CENTRAL VALVE SOCKET

VW/ AUDI 凸輪軸調節閥套筒

- Used for removing and installing the central valve for camshaft adjustment.
- Application: Audi A3 with 4-cylinder gas direct injection, 1.8 liter, 2.0 liter, 4v, TFSI engine with chain.
- ENGINE: CCZA, CCZB, CCZC, CDAA, CDAB.
- **VW OEM no.ref. :** T10352.



H.C.B-B1473

VW/ AUDI CAMSHAFT CENTRAL VALVE SOCKET (Dr. 3/8")

VW/ AUDI 凸輪軸調節閥套筒 (Dr. 3/8")

- Used for removing and installing the central valve for camshaft adjustment.
- Application: Passat 2006> Passat CC 2009> Audi A3 2004> 4-cyl. injection engine (1.8 liter and 2.0 liter engine, chain drives).
- **VW OEM no. ref.:** T10352/1.



H.C.B-C1473

VW/ AUDI CAMSHAFT CENTRAL VALVE SOCKET (Dr. 3/8")

VW/ AUDI 凸輪軸調節閥套筒 (Dr. 3/8")

- Used for removing and installing the central valve for camshaft adjustment.
- Application: Used for removal and installation of camshaft control valve on 1.8 and 2.0 generation III TFSI engine.
- Type / model: Audi A4 2008 >, Audi A5 Cabriolet 2009 >, Audi A5 Coupe 2008 >, Audi Q5 2008 >, Audi A3 2012 > 4-cyl. 1.8l, 2.0l 4V TFSI direct injection engine (generation III)
- **VW OEM no. ref. :** T10352.



H.C.B-D1473

NEW

VW/ AUDI CAMSHAFT CONTROL VALVE 1.8/2.0 TFSI SOCKET

VW/ AUDI 凸輪軸調節閥 1.8/2.0 TFSI 套筒

- Used for the removal and installation of camshaft control valve on 1.8 and 2.0 generation III TFSI engine.
- Application: Audi A4 2008 >, Audi A5 Cabriolet 2009 >, Audi A5 Coupe 2008 >, Audi Q5 2008 >, Audi A3 2012 >
- Applicable engine: 4-cyl. 1.8l, 2.0l 4V TFSI direct injection engine(generation III)
- **VW OEM no. ref.:** T10352/2





H.C.B-A1479

VW DRIVE FLANGE OIL SEAL REMOVER/INSTALLER

VW 傳動軸拆裝工具

- For removing and installing universal drive flange oil seal.
- Pull in differential complete with freewheel, pull off drive flange with gearbox in place.
- Two screws: M8 x 30, M10x30 hexagon bolts into the flange.
- Application: AUDI and VW.
- VW OEM no. ref. : VW 391.



H.C.B-A1486

VW OIL FILTER WRENCH (Dr. 1/2", 15 POINTS, 92 mm)

VW 機油芯扳手 (Dr. 1/2", 15 角, 92 mm)

- For the operation of oil filters (KNECHT and MAHLE filters) 15-point 92 mm wrench.
- Application: VW-AUDI Passat 1.9 TDi until 11/2000, 2.8 L until 04/1999, CHRYSLER 300 M, PORSCHE, OPEL, RENAULT, FORD Focus 1.8 Di since 08/ 1999, 1.8 TDi since 10/1998, Maverick 2.7 TD until 1996, Mondeo 2.5 L until 2000, MITSUBISHI, NISSAN, ALFA-ROMEO, HONDA, VOLVO...etc. MAN (commercial vehicles) F 2000.
- Inside square drive 12.5 = 1/2 or outside hexagon 27 mm/ diameter: 102 mm.



H.C.B-A1489

VW (TIGUAN/ GOLF) SUB-FRAME BUSH EXTRACTOR/INSTALLER

VW(TIGUAN/GOLF) 三角架鐵套拆裝工具

- This tool is designed to remove and install the bushing.
- Application:
VW A3 (04~), GOLF (04~), PASSAT (06~), JETTA (06~), TIGUAN (08~), TT (06).



H.C.B-A2256 VAG/ FORD (1.2D,1.4D,1.6D,1.9D,2.0D,TDI PD/CR) DIESEL ENGINE TIMING TOOL KIT

VAG/FORD (1.2D, 1.4D, 1.6D, 1.9D, 2.0D TDI PD/CR) 柴油正時工具組

- Suitable for engine timing and belt replacement on pump duse diesel engines fitted to VAG vehicles and Ford Galaxy from 1999 on 2006.
- Covers huge range of 1.9TDi engine variants.
- Kit contains latest crank locking tools for "Round" and "Oval" crankshaft gears, camshaft pins and tensioner tools for hydraulic and mechanical belt tensioners.
- Application:
AUDI: A2 (01-06), A3 (01-08), A4 (99-08), A6 (98-08).
VW: Lupo (99-05), Polo (99-08), Fox (05-08), Golf/ Bora (98-08), Golf Plus (05-08), Jetta (05-08), Beetle (00-08), Passat (98-08), Touran (03-08), Sharan (99-08), Caddy (03-08), Transporter (03-08).
Ford :Galaxy (99-06)
Seat: Arosa (99-05), Ibiza/ Cordoba (02-08), Altea (04-08), Leon (00-08), Toledo (04-08), Alhambra (99-08).
Skoda: Fabia (00-07), Roomster (07-08), Octavia (00-08), Superb (02-08).



- Engines:
1.2 TDi PD: ANY, AYZ.
1.4 TDi PD: AMF, ATL, BAY, BHC, BNM, BNV.
1.9 TDi PD: AJM, AMG, ANU, ARL, ARX, ASZ, ATD, ATJ, AUY, AVB, AVF, AVQ, AWX, AXB, AXC, AXR, BEW, BJB, BKC, BKE, BLS, BLT, BPX, BRB, BRM, BRU, BSV, BSW, BTB, BVK, BXE.
2.0 TDi PD: AZV, BKD, BDJ, BDK, BGW, BHW, BKP, BLB, BMA, BMM, BMN, BMP, BMR, BNA, BPW, BRC, BRE, BRF, BRT, BSS, BUY, BUZ, BVE, BVF, BVG, BVH, BWV.
- VW OEM no. ref.: T10100/ T10050 (23-059) / 3359 (T20102) / U30009A (3387/ T10004) / T10020/ T10265/ T10264/ T10115/ T10008 (310-084)/ T10060 (T20167).

H.C.B-B2256 VAG FRONT END SUPPORT GUIDE KIT

VAG 前端面板支撐架零件組

- Suitable for extending the front panel of the vehicle to provide increased space in engine compartment for carrying out various service applications.
- These guides support the front end when it is extended out to "Service Position", which on a number of models, it is required as part of the timing belt replacement procedure.
- Application:
AUDI: A4/ A6/ A8.
SEAT: Ibiza/ Cordoba/ Arosa/ Leon/ Toledo/ Alhambra/ Altea.
VW: Lupo/ Polo/ Bettle/ GOLF/ Bora Passat/ Touran/ Sharan/ Phaeton Touareg.
- VW OEM no. ref.: VW 3369/ 3411.

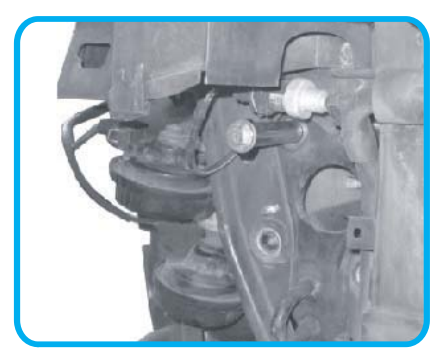



H.C.B-A1501

VW/ AUDI FUEL PUMP WRENCH

VW/ AUDI 汽油幫浦拆裝器

- Special designed wrench to remove and install the fuel pump.
- Using the wrench to turn inner section of surge housing approx. 15° to the left up to the stop and withdraw fuel pump assembly complete with the inner housing section.
- Application:
Audi: A4 (2002-2004 AWD),
A6 (1999-2004),
90 QUATTRO (B4), S4, S6, RS6.
Volkswagen: Passat (1998-2005).
- **VW OEM no. ref.:** 3307.

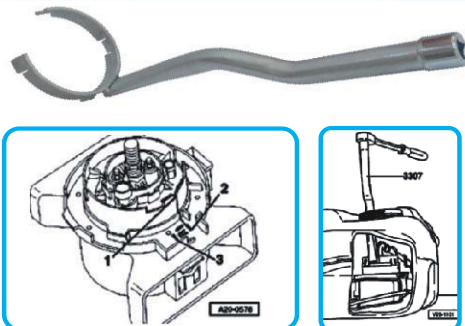

H.C.B-A1505

AUDI/ GOLF/ OCTAVIA/ LEON CAMSHAFT LOCK TOOL

AUDI/GOLF/OCTAVIA/LEON 凸輪軸固定工具

- Locking camshaft when checking and adjusting timing.
- Application:
Type / model: Audi A3 2013 >, Golf 2013 >,
Octavia 2013 >, Leon 2013 >
Assembly group: 4-cyl. injection engine (1.4
l direct injection engine, turbocharger) 4-cyl.
injection engine (1.2 l direct injection engine,
turbocharger).
- **VW OEM no. ref.:** T10494.



H.C.B-A1506

VW COUNTER HOLDER

VW 曲軸支撐扳手

- To avoid disturbing valve timing, do not turn crankshaft out of TDC position.
- Used to counter holding vibration damper when center bolt for crankshaft is loosened or tightened.
- Application: 1.8L & 2.0L TSI engines.(2004 ~)
- Total length : 840 mm
- **VW OEM no. ref.:** T10355.



H.C.B-D1506

NEW

VAG 1.8/2.0 TSI/TFSI (EA888) ENGINE TIMING TOOL KIT

VAG 1.8/2.0 TSI/TFSI (EA888) 引擎正時工具組

- Used for correcting the camshaft and crankshaft timing position.
- Four-cylinder EA888 petrol: 1.8 R4 16v TSI/TFSI, 2.0 R4 16v TSI/TFSI
- Applications:
2006~2013 VAG series TSI, TFSI EA888 engine(1.8L, 2.0L).
- Engine Code: BYT, BZB, CABA, CABB, CABD, CADA, CAEA, CAEB, CAWA,
- **VW OEM no. ref.:**
T10355, T10368, T40196, T40267, T40271, T10352, T10352/1, T10352/2,
T10354, T10265, T10060A, T10340



H.C.B-B1506 **VW/ AUDI 2.0L TURBO ENGINE TIMING TOOL KIT**

VW/ AUDI 2.0L 渦輪引擎正時工具組

- Applicable to 2009 and newer VW/ AUDI models with the 2.0 L Turbo (CAEB) engine.
- Kit contains the following tools.

Item no.	VW OEM no. ref.	Description	
1	A1506	T10355	Counter holder
2	B1506-2	T10368	Press piece – timing chain cove
3	B1506-3	T40196	Camshaft pins
4	B1506-4	T40267	Tensioner locking tool
5	B1506-5	T40271	Camshaft locks cams
6	B1506-6	VW 10352	Assembly tool

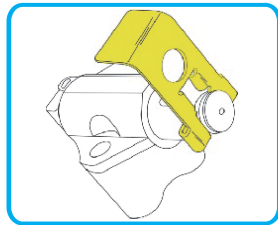

H.C.B-A1551 **VW CAMSHAFT COUNTER HOLDER**

VW 凸輪軸支撐扳手

- Used to counter-hold camshaft when loosening and tightening camshaft gear hub bolt.
- Application: VW 1.9L TDI-PD (BEW) (BRM), 2.0L 4V TDI (CBEA).
VW: GOLF(04~09), Jetta (05~06), Jetta (09).
- **VW OEM no. ref.:** T10051.

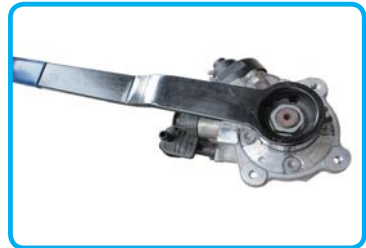

H.C.B-B1551 **VW CAMSHAFT SPROCKET PULLER**

VW 凸輪軸齒輪拔取器

- Used to remove camshaft sprocket from taper on camshaft.
- Application: Volkswagen 1.9L TDI pompe-duse (BEW) (BRM) & 2.0L (4v) TDI (CBEA).
VW: GOLF(04~09), Jetta (05~06), Jetta (09).
- **VW OEM no. ref.:** T10052.

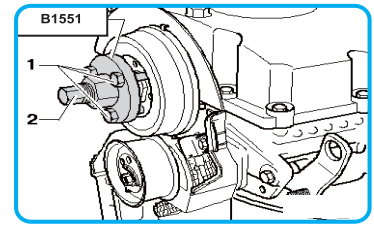



H.C.B-C1551

VW/AUDI VAG DIESEL ENGINE CAMSHAFT SPROCKET TOOL

VW/ AUDI VAG 柴油引擎凸輪軸鏈條拆裝工具組

- Used to counter-hold camshaft when loosening and tightening camshaft gear hub bolt.
- Used to remove camshaft sprocket from taper on camshaft.
- Application:
VW 1.9L TDI-PD (BEW) (BRM) and 2.0L 4V TDI (CBEA)
VW: GOLF(04~09), Jetta (05~06), Jetta (09)
- **VW OEM no. ref.:** T10051/T10052.



H.C.B-A1507

VW PULLEY PULLER

VW 皮帶拉拔器

- Used to remove the toothed-belt pulley from the high pressure pump.
- Application: 6-cyl. TDI Common Rail, 2.0 liter TDI Common Rail.
- **VW OEM no. ref.:** T40064.



H.C.B-A1508

VW CIGARETTE LIGHTER RELEASE TOOL

VW 點菸工具

- Used to remove 12 volt socket.
- Application:
Audi A4 2001 / Audi A4 2008/ Audi Q5 2008/
Audi A6 2005/ Audi Q7 2007.
- **VW OEM no. ref.:** T40148.



H.C.B-A1509 VW TRANSMISSION SUPPORT DEVICE

VW 變速箱拆裝支撐架

- Used to support engine when removing transmission.
- Suitable for VW T4 Vans (short bodywork)
- Designed to lift and pull forward the engine/ gearbox assembly. For the removal and installation of clutch and gearbox on VW T4 essential to support the engine with engine lifter A1509. After undoing all mounting bolts, loosening the exhaust flange and removal of all connections, the engine must be lifted and pulled or pushed to the right front side until the pulley of the crankshaft gets almost in contact with the frame. Only then will it be possible to remove the gearbox and change the clutch.
- Advantages:
 - Easy installation of the engine lifter on the vehicle.
 - Support of upper wishbones by retaining wedges for removal of the drive shaft.
 - Support and correct positioning of the engine in every wanted position.
 - Easy removal and installation of gearbox and clutch.
 - Applicable for 4 and 5 cylinder engines.
 - Safety fixture avoids caught in fingers in the tool's support.
- VW OEM no. ref.: VW 3184/ 3230/ 3227.

Note:

- Removal and installation of gearbox and clutch without engine lifter A1509 is a dangerous procedure.

No.	Description	Q'ty
1	Lifting frame	1
2	Support	1
3	Retainer for 4-cylinder engines	1
4	Retainer for 5-cylinder engines	1
5	Set of supporting wedges (2 pieces)	1

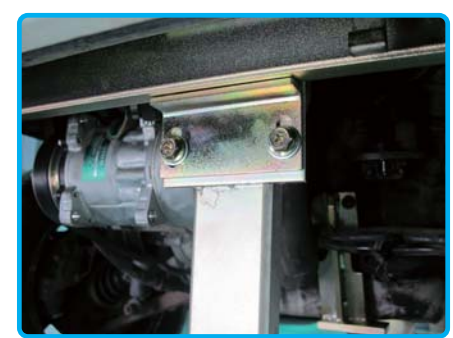

H.C.B-A1513 VAG TDI DESIEL ENGINE CYLINDER COMPRESSION PRESSURE HOSE

VAG TDI 柴油引擎汽缸壓縮壓力油管

- This tool is designed for testing the diesel engine cylinder compression pressure.
- Check compression pressure by using compression pressure tester A2225.
- Application: VAG TDI diesel engines.
- VW OEM no. ref.: VAG1381/ 12.





H.C.B-C1514

NEW

VW CRAFTER CRANKSHAFT SEAL INSTALLER (DIESEL)

VW CRAFTER 曲軸油封安裝工具 (柴油)

- Application:
Crafter 2006 >5-cyl. diesel engine.
Used for assembly of sealing flange with integrated sender wheel.
- VW OEM no. ref.: T50010



H.C.B-A1514

VW/ AUDI CRANKSHAFT REAR SEAL INSTALLER (DIESEL)

VW/ AUDI 曲軸後油封安裝工具 (柴油)

- This crankshaft seal installer is specifically designed for Volkswagen Golf, Touran and AUDI A3, A4.
- It is also suitable for other four-cylinder diesel engine applications including 1.4i Turbo, 1.4/ 1.6 Direct Injection(Petrol), 1.9/ 2.0 SDI, 2.0 TDi, 2.0 Common Rails (Diesel).
- VW OEM no. ref.: T10134

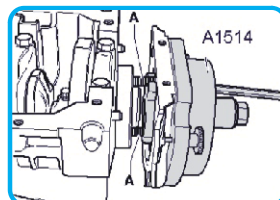

H.C.B-B1514

VW/ AUDI CRANKSHAFT REAR SEAL INSTALLER

VW/ AUDI 曲軸後油封安裝工具

- This crankshaft seal installer is specifically designed for VAG vehicles with 16v 1.4 and 1.6 engines
Including: Seat Arosa 1.4, Ibiza 1.4, Cordoba 1.4, Leon,1.4/ 1.6, Toledo 1.4/ 1.6, and Inca 1.4 16v Skoda Facia 1.4, Fabia II 1.6, Octavia 1.4 and Roomster 1.4 16v Volkswagen Lupo 1.4/ 1.6, Polo 1.4/ 1.6, Polo Classic 1.4, Golf/Bora 1.4/1.6, Beetle 1.4, Caddy 1.4 16v.
- VW OEM no. ref.: T10017.

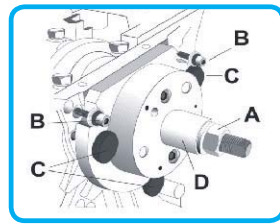

H.C.B-A1519

VW T5 CRANKSHAFT TURNING TOOL (Dr. 1/2")

VW T5 曲軸旋轉工具 (Dr. 1/2")

- Used to turn crankshaft over when removing and installing camshaft timing chain.
- Application: 3.2L V6 4v (CALA), 4.2L V8 5-Valve Chain-Style engine.
- **VW OEM no. ref.:** T40049.

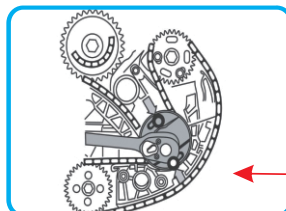

H.C.B-A1515

VW T5 WHEEL HUB/WHEEL BEARING TOOL KIT

VW T5 輪軸 / 培林拆裝工具組

- The design of this kit can prevent the new wheel bearing from damaged because it provides safe and accurate centering and alignment when changing wheel bearings.
- This tool is designed for wheel/ hub bearing installation and removal.
- Application: VW T5.

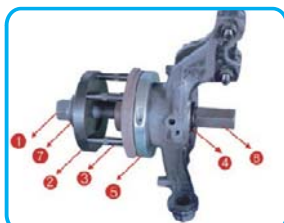

Removal for Front Wheel



Installation for Front Wheel

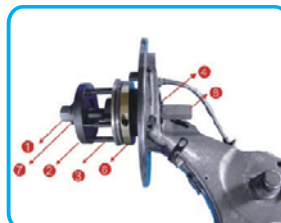

Removal for Rear Wheel

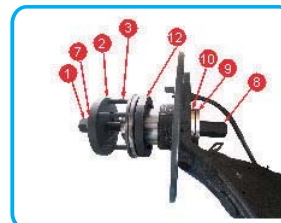

Installation for Rear Wheel

H.C.B-A1522

VW/ AUDI (2.4/3.0/3.2/4.2/5.0/5.2) CAMSHAFT TIMING TOOL KIT

VW/ AUDI (2.4/3.0/3.2/4.2/5.0/5.2) 凸輪軸正時工具組

- This tool is used for adjusting camshaft timing.

Item no.	OEM ref	Description	
1	A1081	Pulley holding tool	
2	A1471	T40133	Timing tool
3	C1413-1	T40070	Camshaft locking tools
4		40079	Camshaft adjuster key
5	A1105-4	3242	Crankshaft locking pin
6	A1105-6	T40069	Crankshaft locking pin
7	A1425	T40058	Crankshaft socket
8	C1413-2	T40071	Locking Pin
9	A1519	T40049	Crankshaft turning tool (Dr.1/2")





H.C.B-A1525

VAG (2.7D, 3.0D TDI V6, 4.0D, 4.2D TDI V8) DIESEL ENGINE SETTING/ LOCKING & HP PUMP REMOVAL TOOL KIT

VAG (2.7D, 3.0D TDI V6, 4.0D, 4.2D TDI V8) 柴油引擎正時工具 & 馬力泵浦拆卸工具組

- This engine timing tool set is for VAG 2.7/3.0 TDI and TDI CR chain driven engines.
- It can be used on diesel engines fitted to Touareg and Phaeton plus the 4.0 TDI engine (ASE) in the Audi A8 (-10).

■ Specification:

Ref	Items no.	VW OEM no. ref.	Description
1		T40061	Crankshaft alignment/ locking tool
2		T40062	Crankshaft sprocket holding tool
3	A1519	T40049	Crankshaft turning tool - type2
4		T40135	High pressure pump sprocket locking tool
5	A1105-4	3242	Crankshaft locking pin
6	A1425	T40058	Crankshaft turning tool - type1
7		T40060	Crankshaft locking pin (2)
8		T40245	Locking pin
9	A1507	T40064	Puller - pulley
10	C1413-2	T40071	Locking pin
11			Locking pin



■ Application:

MAKE	MODEL	ENGINE TDI	CODES	YEAR
AUDI	A4	2.7 TDI	BPP	01-08
AUDI	A4	2.7 TDI	BSG	01-08
AUDI	A4/ A6/ A8	3.0 TDI	ASB	05-
AUDI	A4	3.0 TDI	BKN	01-08
AUDI	A4/ A5	3.0 TDI	CAPA	07-
AUDI	A6/ ALLROADER	2.7 TDI	BPP/ BSG	05-
AUDI	A6/ ALLROADER/ A8	3.0 TDI	BNG/ BMK	03-
AUDI	A6/ Q7	3.0 TDI	BMZ/ BUG/ BUN	05-
AUDI	A8	5.0 TDI	ASE	03-10
VOLKSWAGEN	PHAETON	3.0 TDI	BMK/ CARA	04-
VOLKSWAGEN	TOUARGE	3.0 TDI	BKS/ BUN/ CASA/B	05-

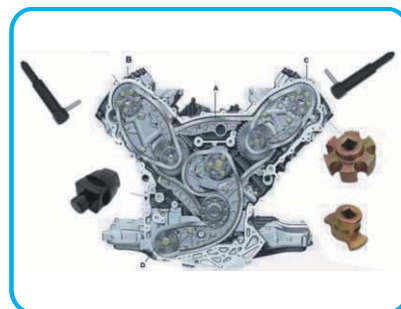

H.C.B-A2260

SPLINE IMPACT BIT SOCKET KIT (Dr. 1/2") (4 PCS)

12 角星型氣動套筒組 (Dr. 1/2") (4 PCS)

- Manufactured in quality chrome vanadium.
- Material: SNCM-V with manganese phosphate.
- Size: M12-14-16-18.
- Overall length: 77 mm.
- Popular sizes for VAG rear hubs.



XZN
Spline

Item no.	Description	Applications
A2260-12	M12 x 77 mm (L.)	for rear hubs on Touran
A2260-14	M14 x 77 mm (L.)	for rear hubs on LT/ Transporter
A2260-16	M16 x 77 mm (L.)	for rear hubs on Sharan
A2260-18	M18 x 77 mm (L.)	for rear hubs on GOLF

H.C.B-A2267 VW/ AUDI FLEXIBLE MULTI-TOOTH SOCKET (Dr. 3/8" XNZ, M10 x 130 mm (L))

VW/ AUDI 套筒 (Dr. 3/8" XNZ, M10 x 130 mm (L))

- This tool allows the quick and easy removal and installation of drive shafts.
- This special designed socket enables to fasten screws that are hard to access to be loosened and tightened without any trouble.
- This tool is not suitable for using with an impact wrench.
- Size: Dr. 3/8" XNZ, M10 x 130 mm (L).
- Material: CR-V socket and S2 bits.
- Application: VW GOLF IV, PASSAT.



H.C.B-A2268 VAG 1.2 L (3CYL.) - 6V/12V PETROL ENGINE TOOL KIT

VAG 1.2 公升 (3 汽缸) - 6V/12V 汽油引擎工具組

- This tool is designed for Volkswagen Lupo and Polo 3 cylinder 6/ 12v 1.2 liter engines. Also Seat Cordoba and Ibiza 1.2 petrol engines (2002-2009).
- Camshaft timing tools for VAG single camshaft (6v-AWY, BMD) and twin camshaft (12v-AZQ, BME).
- VW OEM no. ref.: T10120/T10121/T10123

Manufacturer	Model	Style	Engine Code	Year
Seat	Ibiza	1.2 - 6v I 3 cyl	AWY I BMD	2002-2009
Skoda	Fabia	1.2 - 6v I 3 cyl (55bhp)	AWY I BMD	2003-2009
	Fabia	1.2 - 12v I 3 cyl (65bhp)	AZQ I BME	2003-2009
Volkswagen	Polo	1.2 - 6v I 3 cyl (55bhp)	AWY I BMD	2002-2009
	Polo	1.2 - 12v I 3 cyl (65bhp)	AZQ I BME	2002-2009

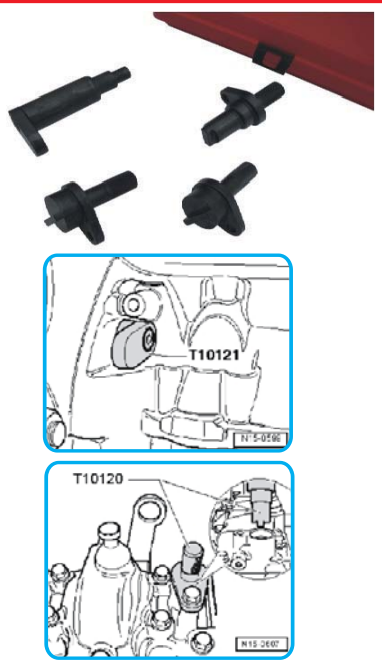

H.C.B-A1604 VAG 2lt 4CYL OIL SUMP PLUG REMOVAL TOOL (Dr. 1/4")

VAG 2lt 4 汽缸油底殼拆卸工具 (Dr. 1/4")

- Developed specifically for the plastic sump plugs found on the latest VAG range.
- This plug is also used in the cam cover on the latest 1.6 and 2.0 twin cam diesel engines found in the VAG range.
- Application:

Manufacturer	Model	Engine	Year
Audi		2.0 L 4 cyl TDI GEN III engines	2013
Seat	Leon	2.0 L 4 cyl TDI GEN III engines	2013
VW	Golf Mk VII	2.0 L 4 cyl TDI GEN III engines	2013

- Sump Plug OEM no. ref.: 06L-103-801





H.C.B-I2016

VW T5 ENGINE SUPPORT BRIDGE

VW T5 引擎平衡桿

- Used for supporting engine during removal and installation of gearbox.
- With extended fix base and adjustable supporting seat, make it suitable for most cars. With round rubber pad can let it stand steady.
- With two hooks and two chains, it is good for securely hoisting all kinds of engines and transmission.
- Application: Transporter 2004 >, VW T5.
- Specification: L 578 mm x W 1830 mm x H 145 mm.
- **VW OEM no. ref.:** 10-222a/ 23.



H.C.B-A1584

VW/ AUDI CAMSHAFT DIESEL ALIGNMENT TOOL

VW/ AUDI 凸輪軸柴油正時工具組

- For adjusting valve timing, and working on the crankshaft, valve train, timing belt replacement....., etc. without removing of the valve cover.
- Special design to set camshaft in the correct position for diesel engine.
- Application:
1999-2003 Volkswagen Polo, Golf, Bora, Beetle, Caddy (at ~ 04), Audi, Skoda and Seat with 1.9 L Diesel TDI and SDI engines 66 KW and 81 KW
- **VW OEM no. ref.:** T10098A.



H.C.B-A1547

VW/ AUDI DRIVE SPROCKET ADJUSTMENT TOOL

VW/ AUDI 驅動齒輪調整工具

- Drive gear wheel adjustment tool for engines with mechanical vacuum pump. Hold the high pressure vacuum pump chain sprocket when adjusting cam / crank timing.
- Application: Audi Q7, [2007-2009] 3.6L [V6] (4v) (BHK) (BLV) with mechanical Vacuum Pump/ Passat 2006>, Touareg 2003>.
- **VW OEM no. ref.:** T10363.

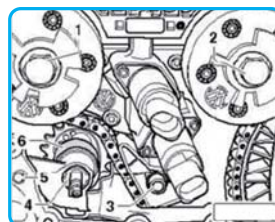
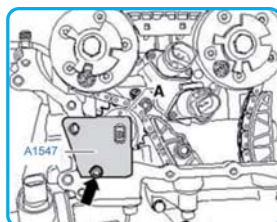

H.C.B-A1548 VW/ AUDI DRIVE SPROCKET ADJUSTMENT FIXTURE TOOL

VW/ AUDI 驅動齒輪調整固定工具

- Used when adjusting valve timing.
- For engines without Mechanical Vacuum Pump.
- Application: Passat with 3.6 L 6-cyl. 4V engine (BLV), Audi Q7 with 3.6 L V6 4V engine BHL, BHK.
- VW OEM no. ref.: T10332

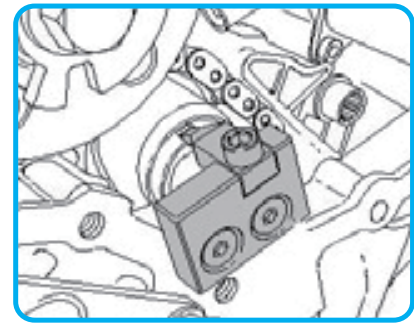

H.C.B-A1549 VW/ AUDI FLYWHEEL LOCKING TOOL

VW/ AUDI 飛輪固定器

- This tool is designed for locking flywheel.
- Application: VW and SKODA 1.9 TDI engine

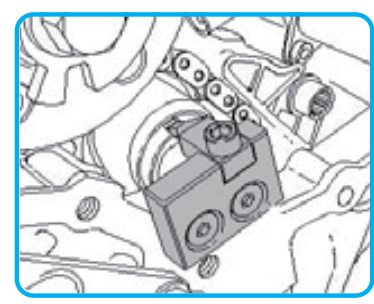

H.C.B-B1447 VW GTI FRONT SUSPENSION SHOCK ABSORBER SPRING COMPRESSOR

VW GTI 彈簧避震器拆裝工具

- For separating the subframe and shock absorber.
- Application: VW GOLF 7 GTI





H.C.B-A1552

VW/AUDI 7-SPEED DSG CLUTCH REMOVAL/INSTALLATION TOOL KIT

VW/AUDI 7 速 DSG 變速箱離合器拆裝器

- This tool is designed to install and remove the clutch of gearbox.
- Application:
 - VW Golf 2004 >, Golf Plus 2005 >, Audi A3 2004 > with 7-speed gearbox (code 0AM)
 - Touareg 2003 > with 6-speed gearbox (code 08D)
- **VW OEM no. ref.:** T10323/T10373/T10374/T10376

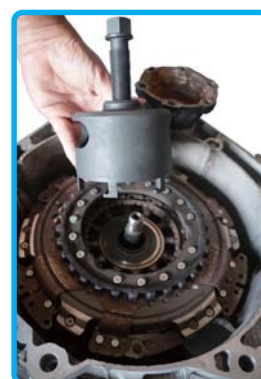
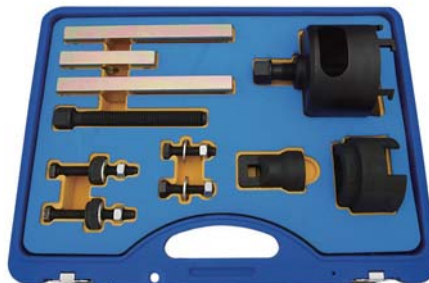

H.C.B-B1552

VW/AUDI 7-SPEED DSG TRANSMISSION SPACER

VW/AUDI 7 速 DSG 變速箱離合器墊塊

- This tool is designed for correcting 7-speed DSG transmission space.
- Application: VW, AUDI (After 2011) with 7-speed DSG (Code: 0AM)
- Combined with A1552
- **VW OEM no. ref.:** T10466



H.C.B-C1552

VW/AUDI 7-SPEED DSG GEARBOX MECHATRONIC ASSEMBLY LEVER

VW/AUDI 7 速 DSG 變速箱離合器閥體拆裝器

- Used to operate the engaging lever during dismantling and mounting of the mechatronic unit on 7-speed DSG gearbox (Code: 0AM).
- Application: VW and AUDI
- Combined with A1552 / B1552
- **VW OEM no. ref.:** T10407



H.C.B-A1544 **VW FRONT SUSPENSION SIENT BLOCK EXTRACTION/ INSTALLATION TOOL KIT (W/ HYDRAULIC CYLINDER)**

VW 前工字樑鐵套拆裝工具組 (油壓式)

- The A1544 pulling device allows the quick and safe removal and installation of assembly carrier double-type silent blocs on the vehicle. Loosening or removing the assembly carrier from the vehicle as well as follow-up wheel alignments is not necessary.



■ Application:

Manufacturer	Model	Year
Audi	A3 (8P1)	05/2003 onwards
Audi	TT (8J3, 8J9)	from 08/2006 to 06/2010
Seat	Altea (5P5, 5P5, 5P8)	03/2004 onwards
Seat	Leon (1P1)	05/2005 onwards
Seat	Toledo III (5P2)	from 04/2004 to 05/2009
Skoda	Octavia (1Z3, 1Z5)	from 02/2004 to 12/2010
VW	Caddy III (2KA, 2KB, 2KH, 2KJ, 2CA, 2CB, 2CH, 2CJ)	from 04/2004 to 08/2010
VW	EOS (1F7, 1F8)	06/2006 onwards
VW	Golf Plus (5M1, 521)	01/2005 onwards
VW	Golf V (1K1, 1K5)	from 10/2003 to 2009
VW	Golf VI (5K1, AJ5)	10/2008 onwards
VW	Jetta III (1K2)	from 08/2005 to 10/2010
VW	Touran (1T1, 1T2, 1T3)	08/2003 onwards
VW	Passat (3C2, 3C5, 362, 365)	from 03/2005 to 06/2010
VW	Scirocco (137)	05/2008 onwards
VW	Tiguan (5N)	09/2007 onwards



H.C.B-B1544 **VW FRONT SUSPENSION SIENT BLOCK EXTRACTION/ INSTALLATION TOOL KIT (MANUAL)**

VW 前工字樑鐵套拆裝工具組 (手動)

- The B1544 pulling device allows the quick and safe removal and installation of assembly of carrier double-type silent blocs performed suitably on the vehicle. Loosening or removing the assembly of carrier from the vehicle without the necessity of follow-up wheel alignments.

■ Application:

Manufacturer	Model	Year
Audi	A3 (8P1)	05/2003 onwards
Audi	TT (8J3, 8J9)	from 08/2006 to 06/2010
Seat	Altea (5P5, 5P5, 5P8)	03/2004 onwards
Seat	Leon (1P1)	05/2005 onwards
Seat	Toledo III (5P2)	from 04/2004 to 05/2009
Skoda	Octavia (1Z3, 1Z5)	from 02/2004 to 12/2010
VW	Caddy III (2KA, 2KB, 2KH, 2KJ, 2CA, 2CB, 2CH, 2CJ)	from 04/2004 to 08/2010
VW	EOS (1F7, 1F8)	06/2006 onwards
VW	Golf Plus (5M1, 521)	01/2005 onwards
VW	Golf V (1K1, 1K5)	from 10/2003 to 2009
VW	Golf VI (5K1, AJ5)	10/2008 onwards
VW	Jetta III (1K2)	from 08/2005 to 10/2010
VW	Touran (1T1, 1T2, 1T3)	08/2003 onwards
VW	Passat (3C2, 3C5, 362, 365)	from 03/2005 to 06/2010
VW	Scirocco (137)	05/2008 onwards
VW	Tiguan (5N)	09/2007 onwards

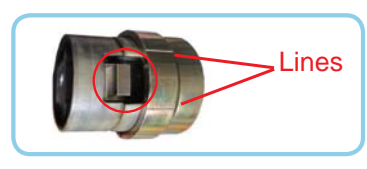
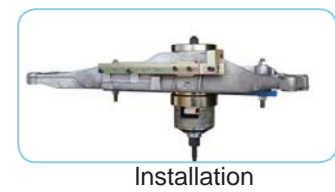



H.C.B-A1536

VW(TOUAREG) / AUDI(Q7) / PORSCHE(CAYENNE) LOWER TRAILING ARM BUSH REMOVER/INSTALLER

VW (TOUAREG) / AUDI (Q7) / PORSCHE (CAYENNE)
前三角架鐵套拆裝工具組



- This tool has a hydraulic system design which can be used with H.C.B-B1129 hydraulic hand pump or H.C.B-A3036 air pump.
- This tool can finish the removal and installation of bush on car which is time-saving and convenient.
- It is designed for removing and replacing the bushings on the lower trailing arm.
- Application: VW Touareg, Audi Q7, Porsche cayenne



H.C.B-E1129

VW GOLF/ AUDI A3 REAR TRAILING ARM BUSHING REMOVER/ INSTALLER (W/ HYDRAULIC CYLINDER)

VW GOLF/ AUDI A3 後游臂鐵套拆裝工具 (油壓式)



- Allow on-car removal and installation without the necessity of removing the rear trailing arm.
- This tool has hydraulic system which can work with H.C.B-B1129 hand pump or H.C.B-A3036 air pump and saves time and labor. This is a must-have tool for installing and removing the bush.

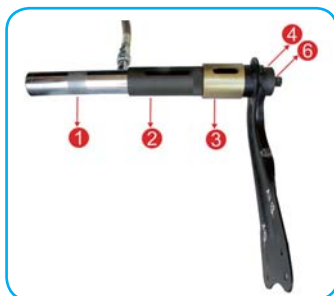

Removal

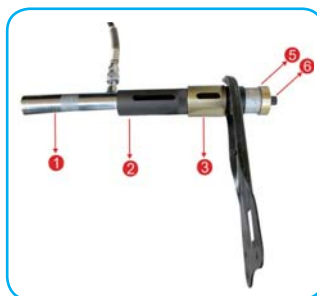

Installation

- Application:
AUDI A3 2004 and after
VW GOLF 2005 and after
VW PASSAT 2005 and after

H.C.B-A1575

**VW T5 FRONT SUB-FRAME BUSH REMOVAL / INSTALLATION TOOL KIT
PAT.M504750**

VW T5 前三角架鐵套拆裝工具組

- This tool is designed for removing and installing the bush.
- Application: VW T5



After 2011

2008-2010

2005-2007



Front bush no.: 26937 01

Rear bush no.: 26935 01



Front bushing Extraction



Front bushing Installation



Rear bushing Extraction



Rear bushing Installation

H.C.B-A1578

VW CRAFTER 2.5 TDI CRANKSHAFT PULLEY HOLDER

VW CRAFTER 2.5 TDI 曲軸皮帶盤支撐扳手



Genuine stock No.:
074105251AC

- For holding the crankshaft pulley of Volkswagen Crafter 2.5 TDI
- Application: VW CRAFTER 2.5 TDI.





H.C.B-A1576

VAG/PORSCHE CAMSHAFT CYLINDER HEAD TIMING TOOL KIT

VAG/PORSCHE 凸輪軸汽缸蓋正時工具組

- Designed for fitting camshafts into cylinder heads during head rebuilds.
- Application: VAG models and Porsche with diesel engine.

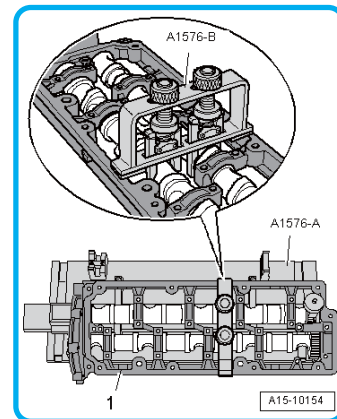
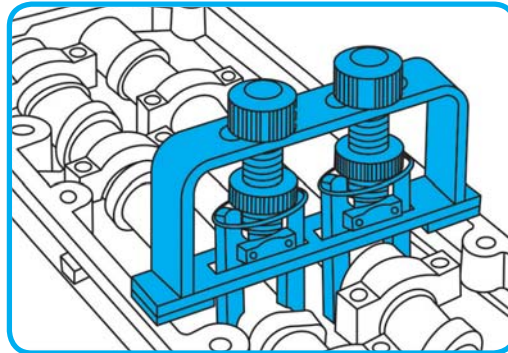
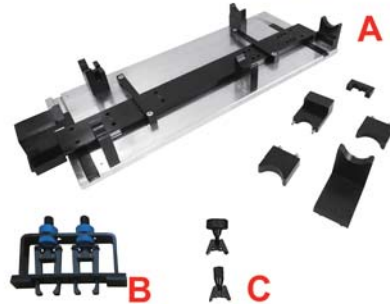

H.C.B-A1580

VAG DIESEL ENGINE TIMING TOOL KIT

VAG 柴油引擎正時工具組

- For the installation and adjustment of phases timing and cylinder head assembly.
- Application: Diesel engines of 1.2 / 1.4 / 1.9 / 2.0 / 2.7 / 3.0 liters (injection system common rail), as well as engines system TDI PD 1.9
- **VW OEM no. ref.:**
3242 / 3359 / T40058 / T40049 / T40060 / T40061 / T40062 / T10050 / T10115 / T10060 / T10100 / T40095 / T40096 (1)



H.C.B-A1591

VW/ AUDI FUEL TANK SENDER WRENCH (A6/A8)

VW/ AUDI 油箱蓋拆裝器 (A6/A8)

- Specially designed to remove and install the fuel pump cap on cars with diesel or petrol engines.
- Application:
Primarily Audi A6 (2005 and above), Audi A8 (1994 and above), Audi A8 (2003 and above) as well as other models
- **VW OEM no. ref.:** T40068A

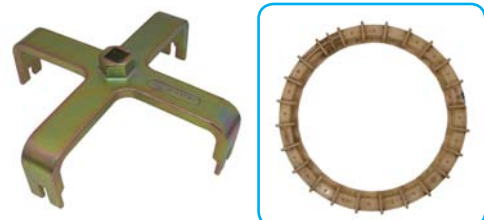

H.C.B-B1594 **NEW** **VAG 1.0, 3 CYLINDER ENGINE TIMING TOOL KIT**

VAG 1.0, 3 汽缸引擎正時工具組

- For checking and adjusting engine timing.
- Application: 1.0L 3-cyl petrol engines VW up, SKODA Citigo, SEAT Mii since 2011

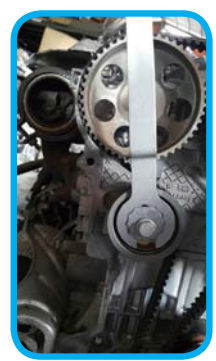

H.C.B-A1595 **AUDI A8 CAMSHAFT LOCATING TOOL KIT**

AUDI A8 凸輪軸正時工具組

- Used to locate camshaft when adjusting timing.
- Application: 1997 - 1999 Audi A8 (V8 4V engine)
- VW OEM no. ref.: 3341



H.C.B-C2276 **NEW** **VAG 1.6/2.0 TDI CRANKSHAFT TIMING TOOL KIT**

VAG 1.6/2.0 TDI 曲軸正時工具組

- Application:
VW: Golf SV/Sportsvan, Golf VII, Golf VII Estate, Golf VII Wagon, Polo
SEAT: Leon, Leon ST
AUDI: A3 Cabrio, A3 Saloon, A3 Sedan, A3/A3 Sportback, A4, A4 allroad, A4 quattro, A5 Coupe/Cabriolet, A5 Sportback, A6, Q5, TT
SKODA: Octavia III
Motore: 1.4TDI CR, 1.6TDI CR, 1.6TDI CR GreenLine, 1.6TDI CR BlueMotion, 1.6TDI CR Ecomotive, 2.0TDI CR, 2.0 RS TDI CR, 2.0TDI CR Ultra
Codici motore: CKFB, CKFC, CLHA, CLHB, CNHA, CNHC, CRBC, CRBD, CRFA, CRFC, CRKA, CRKB, CRLB, CRLC, CRMB, CRVA, CRVC, CSUA, CSUB, CUNA, CUPA, CUTA, CUSA, CUSB

- VW OEM no. ref.: T10264/T10265/T10490/T10051/T10060A/T10492/3359





H.C.B-B2276

NEW

VAG 1.6/2.0 TDI CRANKSHAFT LOCK TOOL KIT

VAG 1.6/2.0 TDI 曲軸固定工具組

- Used to lock crankshaft at TDC when servicing the 1.8 and 2.0 generation III TFSI engine.
- Used to lock the high pressure pump of the 2.0 TDI common rail engine during removing/installing the high pressure pump or timing belt.
- Application:
Audi A3 2013 >, Golf 2013 >
Assembly group: 4-cyl. Common rail (1.6 and 2.0 l, 4V, turbocharger)
- **VW OEM no. ref.:** T10490/T10492



H.C.B-A2276

VAG 1.2, 1.6 & 2.0 TDI ENGINE TIMING TOOL KIT

VAG 1.2, 1.6 & 2.0 TDI 引擎正時工具組

- This kit allows locking the crankshaft in the correct position for timing, for engines with cylindrical or oval pulleys.
- It also includes an indispensable tool for locking the camshaft and a dedicated special extractor for the extraction of its pulley.
- Application:
 - Skoda: Roomster, Fabia, Praktik, Octavia, Yeti, Superb
 - Audi: A1, A3, A4, A5, A6, Q5, TT
 - VW: Jetta, Touran, Golf, Golf Plus, Polo, Passat, Tiguan, Scirocco
 - Seat: Exeo, Leon, Altea, Toledo, Ibiza
- Applicable engine: 1.2 D TDI CR, 1.6 D TDI CR, 2.0 D TDI CR
- Applicable engine code: CAGA, CAGB, CAGC, CAHA, CAHB, CFHC, CBAA, CBAB, CFFB, CGLA, CGLB, CJCA, CJCB, CAAA, CBAA, CBAB, CBAC, CBBA, CBBB, CBDA, CBDB, CBDC, CCHA, CEGA, CJAA, CAAB, CAAC, CFJA, CFWA, CAYB, CAYC, CAYA
- **VW OEM no. ref.:**
T10264/ T10265/ T10051/ T10052/ 3359/ T40098 (T100601A)/
T10050/ T10100/ T10255



H.C.B-A1607

VW/ AUDI 4 CYLINDER TDI TIMING TOOL KIT

VW/ AUDI 4 汽缸 TDI 正時工具組

- Used for setting and adjusting the cam / crank / pump timing on 1999-2011 Volkswagen TDI engine.
- Application: Volkswagen Beetle / New Beetle 2.5 L / Golf / Jetta / Jetta Sportswagen / Passat
- **VW OEM no. ref.:** T10264 / T10265 / T10115 / T10050 / T10100 / 3359 / T10020 / 3428 / 3387.



H.C.B-A1631 **NEW** **VW WEDGE KIT**

VW 門板翹棒工具組

- Used for general body repairs, for removing the interior of door trim.
- Application: All Volkswagen Cars. Passat CC 2009>
- **VW OEM no. ref.:** T10383.T10383/1.T10383/2

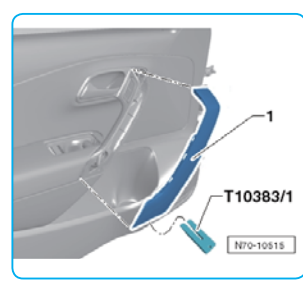
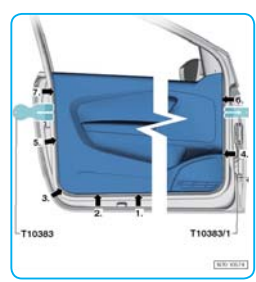

H.C.B-A1632 **NEW** **VAG 1.4 TFSI CAMSHAFT TIMING TOOL KIT**

VAG 1.4 TFSI 凸輪軸正時工具組

- Securing the camshaft when checking and adjusting valve timing.
- Specially designed to secure the position for adjusting camshaft.
- Application: Audi A3 2013 >, Golf 2013 >, Octavia 2013 >, Leon 2013 >4-cyl. injection engine (1.4l direct injection engine, turbocharger)
- **VW OEM no. ref.:** T10504



H.C.B-A1633 **NEW** **VAG 1.8 & 2.0 TFSI CHAIN TENSIONER LEVER**

VAG 1.8&2.0 TFSI 正時鏈條張緊器

- Slackening chain tensioner. This is necessary, for instance, when detaching the timing chain from the camshaft. This tool is essential for generation III and facilitates work on generation I + II.
- Application:
4-cyl. 1.8l, 2.0l 4V TFSI direct injection engine (generation III), Audi A4 2008 >, Audi A5 Cabriolet 2009 >, Audi A5 Coupe 2008 >, Audi Q5 2008 >, Audi A3 2012 >, CC 2012 >, 4-cyl. 1.8l, 2.0l 4V TFSI direct injection engine (generation III)
- **VW OEM no. ref.:**T40243

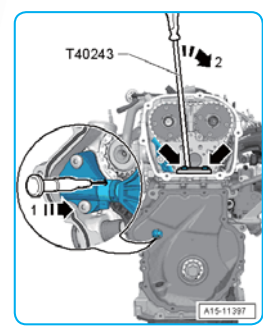



SINCE 1990

010

HWANG CHERNG BIN

Specialty Tools Inc.

SUBARU 修護工具

SUBARU REPAIR TOOL





010

HWANG CHERNG BIN
Specialty Tools Inc.

SUBARU 修護工具
SUBARU Repair Tool

Subaru Repair Tool

H.C.B-A1079-1 SUBARU IMPREZA CRANKSHAFT PULLEY REMOVER/ INSTALLER (6 POINTS, 60 mm)

SUBARU IMPREZA 正時皮帶盤拆裝工具 (6 角 ,60 mm)

- The tool is designed to remove and install the crankshaft pulley.
- Application: IMPREZA/ LEGACY/ FORESTER.
- N.W. : 0.58 KGS.



H.C.B-A1079-2 SUBARU IMPREZA CRANKSHAFT PULLEY REMOVER/ INSTALLER (12 POINTS)

SUBARU IMPREZA 正時皮帶盤拆裝工具 (星型)

40 / 20.8 / 22.3 / 0.62'

- This tool is designed to remove and install the crankshaft pulley.
- Application: SUBARU IMPREZA.



H.C.B-A1079-3 SUBARU IMPREZA CRANKSHAFT PULLEY REMOVER/ INSTALLER (12 POINTS)

SUBARU IMPREZA 正時皮帶盤拆裝工具 (星型)

- This tool is designed to remove and install the crankshaft pulley.
- Application: SUBARU IMPREZA/ LEGACY/ FORESTER.
- SUBARU OEM no. ref.: 499207400.



H.C.B-A1093 SUBARU IMPREZA CRANKSHAFT PULLEY REMOVER/ INSTALLER

SUBARU IMPREZA 正時皮帶盤拆裝工具

10 / 18 / 22 / 2.7'

- This tool is designed to remove and install the crankshaft pulley.
- Application: SUBARU IMPREZA 1800 c.c. (1998-2001)
- N.W.: 1.8 KGS, Length: 770 mm

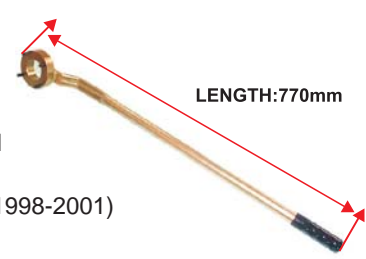

LENGTH:770mm

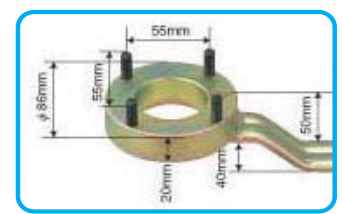



H.C.B-B1093

SUBARU CRANK PULLEY WRENCH

SUBARU 曲軸皮帶支撐扳手

- Perfect for timing belt service or other engine services.
- 2 sets of removable pins allow you to remove style Subaru crankshaft pulley.
- Comparable to both factory tools #499977100, #499977300.
- Application:
 - 93-11 Subaru Impreza
 - 98-09 Subaru Forester
 - 94-09 Subaru Legacy and Outback
 - 05-06 Saab 9-2X
 - 04-06 Subaru Baja
 - 12+ Subaru BRZ
 - 12+ Toyota GT86
 - 12+ Scion FR-S

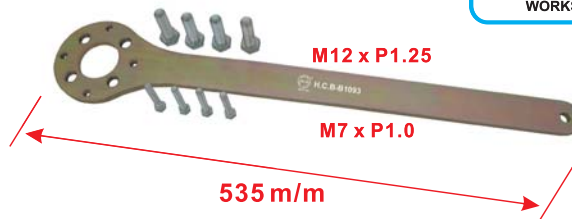

H.C.B-A1134

SUBARU ESTRATTO, TUTTO, DOMINGO OIL FILTER WRENCH

SUBARU 金福相, 金美滿, 多猛哥機油芯扳手

- 14 points, 66.5 mm.
- Application: SUBARU ESTRATTO, TUTTO, DOMINGO
- Easy to use and save time.
- Best choice for maintenance.

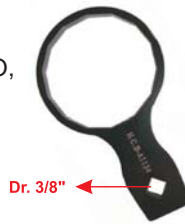

H.C.B-A1149

SUBARU LEGACY 2500 c.c. CRANKSHAFT PULLEY HOLDING TOOL

SUBARU 力獅 2500 c.c. 曲軸皮帶支撐扳手

10 / 15.3 / 18 / 1.48'

- This is a specialty tool developed for Legacy (2500 c.c.) sedan and Forester. It helps extract and install the camshaft pulley.
- The user can replace the pulley on the car without removing the radiator. It saves the unnecessary working hours to take the radiator apart. It must be used together with the torque wrench. Please follow the manual of repair and maintenance published by the original producer while installing.
- Dimensions:
 - Pins: 12 mm (P.C.D: 64 mm)
 - External diameter: \varnothing 90 mm
 - Internal diameter: \varnothing 42 mm
- Application: SUBARU LEGACY 2500 c.c.

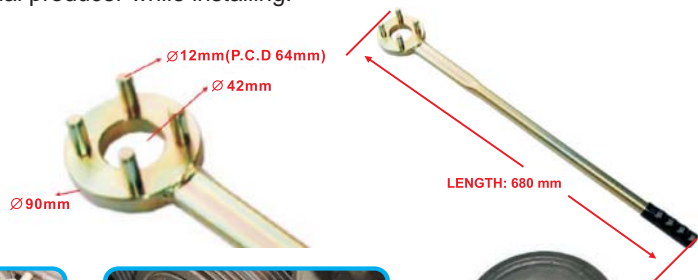

SUBARU legacy 2500 C.C.
Crankshaft pulley

H.C.B-A1151 SUBARU IMPREZA 1800 c.c. CRANKSHAFT PULLEY HOLDING TOOL

SUBARU IMPREZA 1800 c.c. 曲軸皮帶盤支撐扳手

- For holding the crankshaft pulley of the IMPREZA 1800 c.c. vehicles.
- Application: SUBARU IMPREZA 1800 c.c.
- **SUBARU OEM no. ref.:** 499977100

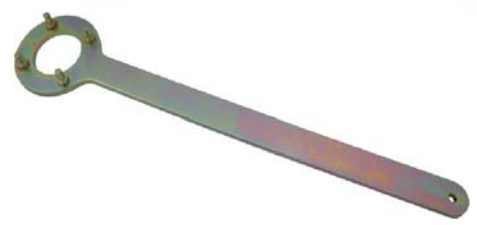

H.C.B-A1152 SUBARU LAGACY 2200 c.c. CAMSHAFT PULLEY HOLDING TOOL

SUBARU 力獅 2200 c.c. 凸輪軸皮帶盤支撐扳手

- For holding the camshaft pulley of the Legacy 2200 c.c. vehicles.
- Application: 93-12 Subaru Impreza SOHC Engine
 99-12 Subaru Forester SOHC Engine
 89-12 Subaru Legacy SOHC Engine
 05-06 Saab 9-2X Linear SOHC Engine
 04-06 Subaru Baja with SOHC Engine
 92-97 Subaru SVX
- **SUBARU OEM no. ref.:** 499207100



H.C.B-A1197 SUBARU AVCS INTAKE CAM SPROCKET TOOL

SUBARU 凸輪軸支撐扳手

6 / 21.5 / 22.5 / 2.9'

- Allow to remove the AVCS intake cam sprockets without damaging the cam or the sprocket.
- Perfect tool for cam seal renewal, cylinder head removal, or motor tear downs.
- High precision cut construction fits perfectly.
- Long handle makes it easy for one person.
- Application:
 - 04+ Impreza WRX STI (intake cams only)
 - 06+ Impreza WRX (intake cams only)
 - 04-11 Forester XT (intake cams only)
 - 05-10 Legacy GT (intake cams only)
 - 04-06 Baja Turbo (intake cams only)
 - 06 Saab 9-2X Aero (intake cams only)

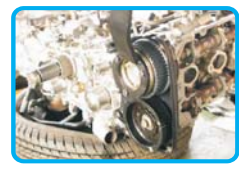
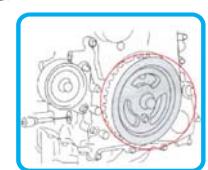



H.C.B-B1197

SUBARU FORESTER 2500 c.c. CAMSHAFT PULLEY HOLDER

SUBARU FORESTER 2500 c.c. 支撐扳手

- For fixing timing belt and easy to remove or install it.
- Front end has 3 points which could hold the pulley of Forester.
- Application: Subaru Forester 2500 c.c.



H.C.B-A1202

SUBARU IMPREZA CAMSHAFT PULLEY REMOVER / INSTALLER

SUBARU IMPREZA 凸輪軸皮帶盤拆裝工具

10 / 12.5 / 14 / 1.4'

- Plastic and iron pulleys are both available.
- This well-designed tool can prevent the camshaft pulley from rotating to help extract the central fixed screw.
- Warning: Tighten the central screw with the torque 30 Nm and turn for 45°.
- Application: Subaru Impreza GT 1999
Subaru Impreza 1600 c.c., 1800 c.c., 2000 c.c.
Subaru Impreza WRX with 2.0 Turbo (2002-2005).
- This tool will NOT fit the 2005 2.0 Turbo with variable cam timing.
- SUBARU OEM no. ref.: 499207400

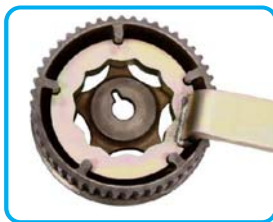

H.C.B-A1285

ON CAR

SUBARU IMPREZA REAR AXLE BUSH EXTRACTOR/INSTALLER

SUBARU IMPREZA 後羊角鐵套拆裝組

5 / 22.7 / 23.7 / 2.02'

- For removing & replacing the metallic bush of rear axle.
- On car maintenance.
- Application: SUBARU IMPREZA

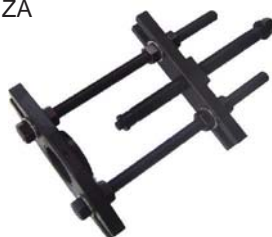

EXTRACTION



Bush

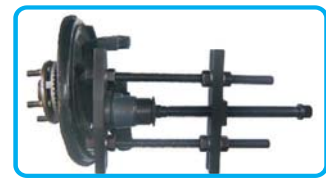

INSTALLATION

H.C.B-A1315

SUBARU 2500 c.c. CAMSHAFT ALIGNMENT TOOL

SUBARU 2500 c.c. 凸輪軸正時工具

30 / 17.64 / 20.2 / 1.31'

- Made from aluminum.
- Camshaft alignment tool for Subaru.
- Only one bar required to do the job.
- Application: SUBARU 2500 c.c. DOHC non-turbo engine.
Ex.: IMPREZA, LEGACY, SVX.
- SUBARU OEM no. ref.: 499207300.



H.C.B-B1315

SUBARU (2.0L/2.5L) CAMSHAFT ALIGNMENT TOOL

SUBARU (2.0L/2.5L) 凸輪軸正時工具

- Made from aluminum.
- Specially designed to align the camshaft timing while replacing the timing belt.
- Only one bar required to do job.
- Application:
SUBARU 2.5L DOHC non-turbo engines, Impreza, Legacy, SVX.
STi 2.0L EJ20 (2002-2005)
STi 2.5L EJ25 (2005-2014)
- SUBARU OEM no. ref.: 499207300 (new).



H.C.B-A1400

SUBARU CAMSHAFT SPROCKET HOLDER

SUBARU 凸輪軸鏈輪扳手

- Used to hold the camshaft sprockets on 2005 and newer Subaru models with the 2.5 L turbo and the 3.6 L 6-cylinder engine.
- Diameter: ϕ 31.7 mm \times 28 mm \times 7 mm
- Total length of the tool: 475 mm
- Some 2.5 L turbo engine might require H.C.B-A1202 as well.
- SUBARU OEM no. ref.: 499977500.

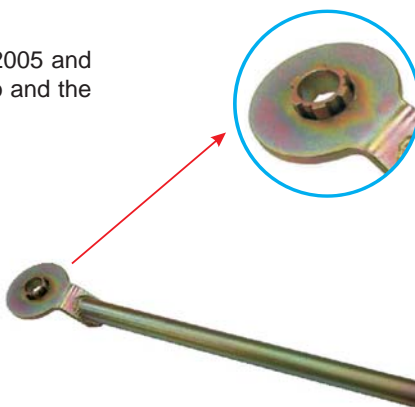

H.C.B-A1459

SUBARU EJ25 CAMSHAFT PULLEY HOLDER

SUBARU EJ25 凸輪軸支撐扳手

- Special internal two curve design for holding the pulley.
- Application: SUBARU EJ25





H.C.B-A1428

SUBARU PUMP TANK LID WRENCH

SUBARU 汽油幫浦油箱蓋拆裝器

- For removing and installing the lid of pump tank.
- It is easy to remove and install.
- The three legs are special designed for removing or installing the lid of pump tank without damaging it.
- Application: SUBARU LEGACY 2.5 L and OUTBACK 2.5 L after 2010.

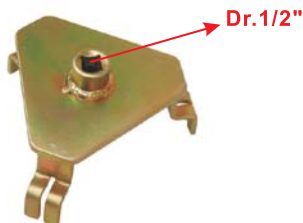

H.C.B-A1450

SUBARU CAMLOCK TOOL

SUBARU 凸輪軸固定工具

- Lock the turning LH side cam sprockets when the timing belt is removed.
- Prevent cam sprockets from spinning when belt is removed and avoid any possibility of valve damage.
- Time-saving and labor-saving. Makes timing belt changes faster and easier, and just require one person to do the job.
- Suitable for various SUBARU models. Apply on all Subaru 2.0 L and 2.5 L DOHC turbo engines.
- Strong neodymium magnets. Make the tools stay in place even hit.
- Curved-design plate offers a good view of sprocket timing marks.
- Application:
 - 02+ Impreza WRX and WRX STI with 2.0 L or 2.5 L DOHC Turbo engines (EJ205, EJ207, EJ255, EJ257)
 - Forester XT with DOHC Turbo engines (04-11)
 - Legacy GT with DOHC Turbo engines (05-10)
 - Saab 9-2X Aero with DOHC Turbo engines (05-06)
 - Baja with DOHC Turbo engines (04-06)



H.C.B-B1450

NEW

SUBARU CAMLOCK TOOL

SUBARU 凸輪軸固定工具

- Lock the LH side cam sprockets from turning when the timing belt is removed.
- Prevent cam sprockets from spinning when belt is removed and eliminate potential valve damage.
- Save time! Make timing belt changes faster and easier especially when done with one person.
- Strong neodymium magnets ensure the tool stays in place even if bumped.
- Curved plate allows easy viewing of sprocket timing marks.
- Application:
 - 96-98 2.5 L DOHC Phase 1 n/a Subaru engines.
 - Early turbo EJ Subaru engines.
 - Turn In Concepts FU Cam bolts.



H.C.B-A1463

SUBARU CRANK SOCKET (Dr. 1/2")

SUBARU 曲軸套筒 (Dr. 1/2")

- Crankshaft rotating socket slips on over the crank snout.
- Enable an engine builder to rotate a complete engine with any 1/2" ratchet or breaker bar.
- Designed to allow easy location of TDC when replacing timing belts or other engine work.
- Eliminate risk of crankshaft snout damage or backwards engine rotation.
- **WARNING:** Never use an impact wrench with the crank socket to rotate the engine.
- Application:
 - 93-11 Impreza
 - 98-09 Forester
 - 94-09 Legacy
 - 05-06 Saab 9-2X
 - 04-06 Baja
 - 1-96 SVX
- **SUBARU OEM no. ref.:** 499987500

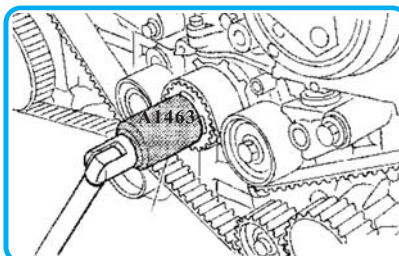

H.C.B-A2284

IMPACT BIT SOCKET TORX PLUS (Dr. 1/2", 78 mm (L), 50 IP)

氣動套筒 TORX PLUS (Dr. 1/2", 78 mm (L), 50 IP)



H.C.B-B2284

IMPACT BIT SOCKET TORX PLUS (Dr. 1/2", 78 mm (L), 55 IP)

氣動套筒 TORX PLUS (Dr. 1/2", 78 mm (L), 55 IP)





010

HWANG CHERNG BIN
Specialty Tools Inc.



SAAB 修護工具
SAAB REPAIR TOOL

H.C.B-A1062 SAAB FUEL TANK LID REMOVER/ INSTALLER

SAAB 油箱蓋拆裝工具 (更換汽油幫浦)

- To remove the fuel tank cup for replacing the pump.
- Application: SAAB.
- N.W.: 0.32 KGS.



H.C.B-A1063 SAAB SOCKET TOOL FOR PRESSURE SWITCH

SAAB ABS 壓力開關專用套筒

- Socket for Saab ABS pressure switch.
- Application: SAAB.
- N.W.: 0.3 KGS.



Dr. 1/2"

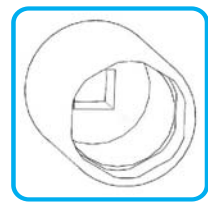

SAAB ABS Pressure Switch



SAAB ABS Pressure Switch



SAAB ABS Pressure Switch



H.C.B-A1312 SAAB CRANKSHAFT REAR OIL SEAL INSTALLER

SAAB 曲軸後油封安裝工具組

- Best tool for replacing crankshaft oil seal.
- Won't damage oil seal and related parts.
- Allow easy and accurate installation of the oil seals which can save time and money.
- Application: SAAB DC 9000 (1994~1996).



OIL SEAL





H.C.B-A1346

SAAB SUSPENSION BUSH EXTRACTOR / INSTALLER (SAAB 95)

SAAB 工字標鐵套拆裝工具組 (SAAB 95)

- To remove and install the front axle damping bushing.
- For replacing the front and rear metallic rear subframe mounting bushes.
- Allow the replacement of the mounting bushes without lowering the complete rear axle assembly.
- Application: SAAB 95.

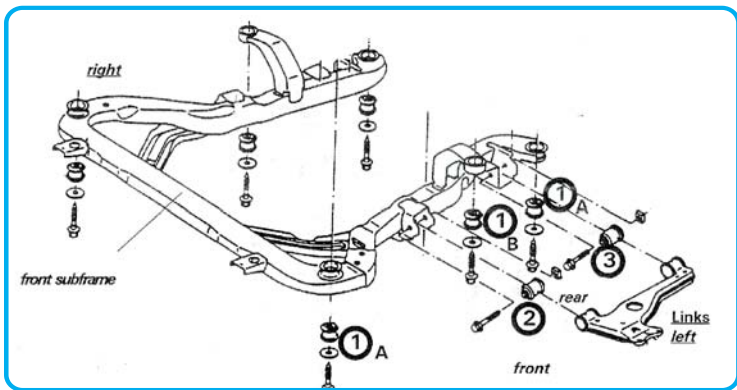

H.C.B-A1367

SAAB (900) CLUTCH PRESSURE PLATE REMOVAL/ INSTALLATION TOOL KIT

SAAB (900) 手排離合器壓板拆裝工具組

- Application: SAAB 2.0T, 1982-1993.

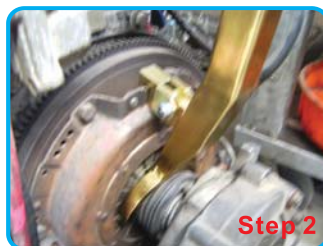
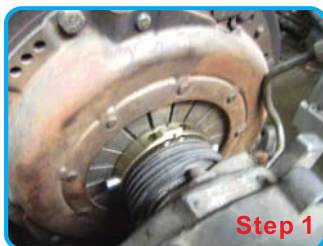



010

HWANG CHERNG BIN
Specialty Tools Inc.

路虎正時工具

LAND ROVER TIMING TOOL





H.C.B-A1484

JAGUAR/ LAND ROVER (V8) 5.0L PETROL TIMING TOOLS

JAGUAR/ LAND ROVER (V8) 5.0L 正時工具

- Timing tool for camshaft alignment, ring gear locking.
- To tension the VVT during the timing procedure.
- A1484-4 allows camshafts to be locked for installation No. 1
- Application:
Jaguar: XF, XFR, XJ, XK8, XKR
Land Rover: Discovery 4, Ranger Rover, Range Rover Sport.
- Applicable engine code: Jaguar AJ-113, Land Rover 508PN/508PS

Parts No.	OEM No.	Description
1	303-1445	Camshaft locking tool
2	303-1447	Camshaft locking tool
3	303-1448	Ring gear locking tool
4	303-1452	Camshafts rotating tool
5	303-1482	Timing chain tensioner

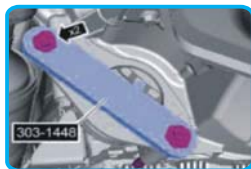
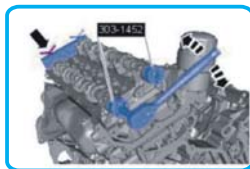
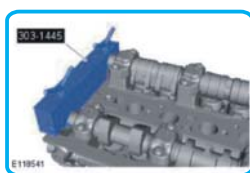

H.C.B-A1485

JAGUAR/ LAND ROVER (V8) 4.2/ 4.4L PETROL TIMING TOOLS

JAGUAR/ LAND ROVER (V8) 4.2/ 4.4L 正時工具組

- This Jaguar V8 timing tool kit includes the following:

Parts No.	OEM No.	Description
1	303-530	Camshaft valve setting tool
2	303-532	Timing chain tensioning tool
3	303-645	Crankshaft setting tool

- To lock the camshafts at TDC position.
- To set camshafts at top dead centre.
- Application: LS - Range Rover Sport, LM - New Range Rover, LA - Discovery 3, X350 - XJ, X308 - V8 XJ series, X250 - XF, X200 - S-TYPE, X150 - XK, X100 - XK Series



H.C.B-A1405

JAGUAR/ LAND ROVER TIMING TOOL KIT

JAGUAR/ LAND ROVER 正時工具組

- To set camshafts at TDC position for timing.
- This tool can properly align the V8 crankshaft when changing timing chains on S-types.
- Kit contains specialized tools required for timing chain setting and locking on Jaguar and Land Rover 3.2, 3.5, 4.0, 4.2, 4.4 V8 petrol engines.

- Application:

Jaguar:

XJ (97-08) (Engine: AJ26)
S-Type (99-08) (Engine: AJ27)
XF (After 08) (Engine: AJ28)
XK (97-08) (Engine: AJ34)

Land Rover (Engine: AJ34):

New Range Rover (06-09) - LM
Range Rover Sport (05-09) - LS
Discovery III (05-09) - LA

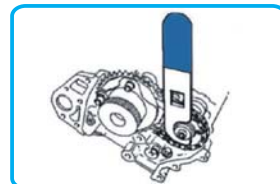



010
HWANG CHERNG BIN
 Specialty Tools Inc.

路虎 正時工具
 Land Rover Tool

Land Rover Tool

H.C.B-B1405 JAGUAR/ LAND ROVER TIMING TOOL KIT

JAGUAR/ LAND ROVER 正時工具組

- To set camshafts at TDC position for timing.
- This tool can properly align the V8 crankshaft when changing timing chains on S-types.
- Kit contains specialized tools required for timing chain setting and locking on Jaguar and Land Rover 3.2, 3.5, 4.0, 4.2, 4.4 V8 petrol engines.
- Application:

Jaguar:
 XJ (97-08) (Engine: AJ26)
 S-Type (99-08) (Engine: AJ27)
 XF (After 08) (Engine: AJ28)
 XK (97-08) (Engine: AJ34)

Land Rover (Engine: AJ34):
 New Range Rover (06-09) - LM
 Range Rover Sport (05-09) - LS
 Discovery III (05-09) - LA

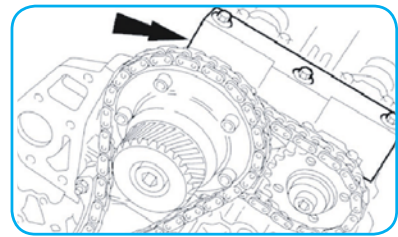
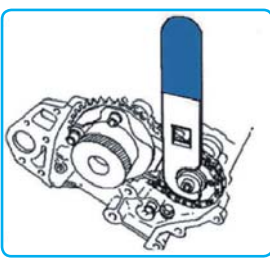

H.C.B-C1405 JAGUAR / LAND ROVER CRANKSHAFT PULLEY REMOVAL / INSTALLATION TOOL KIT

NEW

JAGUAR / LAND ROVER 曲軸皮帶盤拆裝工具組

- Some of these pulley bolts require a torque as high as 375 Nm.
- Crankshaft pulley must be removed for engine overhaul applications / removal of front timing chain cover.
- Combine with H.C.B-A1405
- Suitable for Jaguar and Land Rover 3.2, 3.5, 4.0, 4.2, 4.4 V8 petrol engines.
- Application:

LR3 / Discovery 3 | '05 - '09 | 4.4 LITRE ENGINE ONLY
 Range Rover Full Size 4.4 (Jag Engine) | '06 - '09 | JAG V8 ENGINE
 Range Rover Full Size 4.2 Supercharged (Jag Engine) | '06 - '09 | JAG V8 ENGINE
 Range Rover Sport | '06 - '09
 Range Rover Sport Supercharged | '06 - '09



H.C.B-A2219 JAGUAR/ LAND ROVER ENGINE TIMING TOOL KIT

JAGUAR / LAND ROVER 引擎正時工具組

20 / 17.5 / 18.5 / 1.2'

- Setting and locking set for 2.7 diesel belt drive engines, fitted to both Land Rover and Jaguar vehicles.
- Application: Jaguar S-Type TDVi (04-09), Land Rover Discovery / Range Rover Sport TDV6 (04-09)
- **Land Rover OEM no. ref.:** 303-1172, 303-1126, 303-1116, 303-1117





H.C.B-L1001

JAGUAR FLANGE HOLDING TOOL

JAGUAR 支撐扳手

- To hold drive pinion flange whilst removing/replacing pinion nut. To remove/replace the crankshaft damper. To hold flange whilst removing/replacing flange nut. To hold flange to undo pinion nut. To hold driveshaft flange whilst removing/replacing retaining nut. To hold crankshaft pulley whilst removing/replacing crankshaft bolt. To hold pinion flange whilst removing/installing flange retaining nut. To retain extension housing flange during flange nut removal/replacement. To retain drive flange during pinion nut removal/installation. To retain output flange during removal/replacement of the retaining nut.

■ Application:

Jaguar: X100 – XK Series, X150 – XK, X150 – XK (10MY), X200 – S-type, X250 – XF (10MY), X300 – XJ Sedan, X308 – V8 XJ Series, X350 – XJ, X351 – XJ (10MY), X400 – X-type

Section:

(205) Driveline, (303) Engine, (307) Automatic Transmission

Component Group:

4-Cyl Diesel, Driveshaft, Rear, Rear Drive Axle / Differential, Rear Drive Axle/Differential, ZF6HP, ZF6HP28

- Land Rover OEM no. ref.: 205-053



H.C.B-L1002

LAND ROVER VISCOUS FAN NUT WRENCH

LAND ROVER 螺帽風扇扳手

- To remove/ replace the viscous fan.
- Section: engine (303).
- Application:
Land Rover LS – Range Rover Sport, LM – New Range Rover, LD – Defender 07 MY, LA – Discovery 3 equipped with V6 / V8 Petrol Engine.

- Land Rover OEM no. ref.: 303-1142.



H.C.B-L1003

LAND ROVER HIGH/LOW SELECTION LOCKING TOOL

LAND ROVER 高低壓固定選擇器

- To set the transfer case high/low range selector lever in high range.

■ Application:

Land Rover LD – Defender 07 MY

Section:

Manual Transmission, Clutch and Transfer Case (308)

Component:

MT82, LT230QRS

- Land Rover OEM no. ref.: 308-711



H.C.B-L1004 FORD DURATORQ LOCKING TOOL

FORD DURATORQ 固定工具

- For fuel injection pump sprocket.
- Application: Ford Mondeo / 2001(10/2000-02/2007), Transit / 2000.5 (01/2000-05/2006), Transit / 2006.5 (After 4/2006)
- Applicable Engine:
2.0L Duratorq-DI (Puma) Diesel, 2.0L Duratorq-TDCi (Puma) Diesel, 2.0L Duratorq-TDDi (Puma) Diesel, 2.2L Duratorq-TDCi (Puma) Diesel, 2.4L Duratorq-DI (Puma) Diesel, 2.4L Duratorq-TDCi (Puma) Diesel, 2.4L Duratorq-TDDi (Puma) Diesel, 3.2L Duratorq TDCI (Puma) Diesel
- OEM no. ref.: 303-1151



H.C.B-L1005 JAGUAR/ LAND ROVER CRANKSHAFT REAR SEAL REMOVER/REPLACER

JAGUAR/ LAND ROVER 更換曲軸後油封工具

- To remove/ install the crankshaft rear oil seal, use the punch to remove the transfer case connecting sleeve seal. Use the punch and self tapping screw to allow fitment of 308-615. Use the punch and self tapping screw and pliers to remove the input shaft seal. Use the punch to make hole in countershaft seal. Remove and fit crankshaft rear oil seal.
- Application:
Land Rover: LS - Range Rover Sport, LM – New Range Rover, LF – Freelander 2, LD – Defender 07 MY, LA – Discovery 3
Jaguar: X350 – XJ, X308 – V8 XJ Series, X250 – XF, X200 – S-type, X150 – XK, X100 – XK Series
Section: engine (303), Manual Transmission, Clutch and Transfer Case (308), Driveline (205).
Component: V8 Petrol, Transfer Case, Rear Drive Axle / Differential, 2.2L Duratorq TDCI Diesel (DW), M66 EH50 6 Speed Getrag, MT82.
- Land Rover OEM no. ref.: 303-538.



H.C.B-L1006 JAGUAR/ LAND ROVER ALIGNER

JAGUAR/ LAND ROVER 校準工具

- Allow the oil pump to be removed and refitted in same position to align Pump.
- Application: Land Rover LD – Defender 07MY and Jaguar X400 – X-type.
- Applicable engine: 2.4 L 4-Cylinder Diesel Engine.
- Section: Engine (303).
- Land Rover OEM no. ref.: 303-1093.





H.C.B-L1007

FORD INSTALLER

FORD 安裝工具

- For installing rear wheel hub bearing cone/seal.
- Application:
Ford Cougar / 1999 (08/1998-01/2001), Escort/Orion / 1991 (08/1990-09/2001), Fiesta / 1996 (08/1995-02/2002), Galaxy / 1995 (02/1995-03/2000), Galaxy / 2000.75 (04/2000-02/2006), Ka / 1997 (09/1996-07/2008), Mondeo / 1993 (01/1993-07/1996), Mondeo / 1997 (08/1996-09/2000), Mondeo / 2001 (10/2000-02/2007), Puma / 1998 (06/1997-12/2001), Ranger / 1999 (02/1999-07/2002), Ranger / 2003 (08/2002-08/2006), Streetka / 2003.5 (01/2003-07/2005)
- Ford OEM no. ref.: 205-101.



H.C.B-L1008

LAND ROVER FUEL TANK LOCK RING WRENCH

LAND ROVER 汽油浮筒拆裝器

- To remove/ replace fuel pump/ module locking ring.
- Application:
Land Rover LT - Discovery 2, LP - Range Rover, LN - Freelander, LM - New Range Rover, LJ - Discovery series 1, LD - Defender 07MY.
- Applicable Engine:
Land Rover V8 Petrol Engine, TD5 Diesel Engine, V6 Petrol Engine, TD4 Diesel Engine, 4-Cyl Petrol Engine, TD6 Diesel Engine, 2.4 L Diesel Engine..
- Section: Fuel system (310).
- Land Rover OEM no. ref.: 310-118.



H.C.B-L1009

LAND ROVER FORCING SCREW AND BOLTS

LAND ROVER 加壓螺絲與螺母

- Used with 303-1049 to release the fuel injection pump.
- Application: Land Rover LD - Defender 07MY equipped with 2.4 L Diesel Engine
- Section: Fuel system (310).
- Land Rover OEM no. ref.: 303-1333



H.C.B-L1010

LAND ROVER CRANKSHAFT LOCKING TOOL

LAND ROVER 曲軸固定工具

- To lock the crankshaft in position.
- Application:
Land Rover LF – Free lander 2 equipped with 3.2 L petrol engine
- Section: Engine (303)
- Land Rover OEM no. ref.: 303-1219

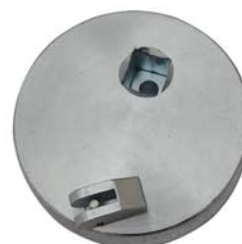



010

HWANG CHERNG BIN
Specialty Tools Inc.

路虎 正時工具
Land Rover Tool

Land Rover Tool

H.C.B-L1011 JAGUAR/ LAND ROVER CLUTCH ALIGNMENT TOOL

JAGUAR/ LAND ROVER 離合器校正工具

- To align clutch disc and pressure plate on installation.
- Application:
Land Rover LD - Defender 07MY and Jaguar X200 - S-TYPE equipped with 2.4 L diesel engine
- Land Rover OEM no. ref.: 308-419



H.C.B-L1012 JAGUAR/LAND ROVER ALIGNER

JAGUAR/ LAND ROVER 校正工具

- To align clutch disc and pressure plate on installation.
- Application:
Land Rover LD - Defender 07MY and Jaguar X200 – S-type equipped with 2.4 L diesel engine
- Land Rover OEM no. ref.: 303-682

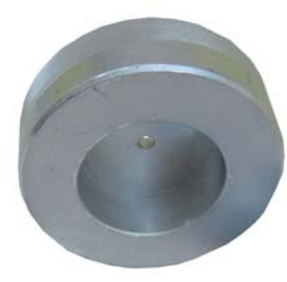

H.C.B-L1013 LAND ROVER DAMPER REMOVER

LAND ROVER 阻尼拆卸器

- Used to release the fuel injection pump.
- Used to remove the crankshaft damper/ pulley.
- Application:
Land Rover LD - Defender 07MY, LA - Discovery 3 equipped with V6 petrol engine.
- Land Rover OEM no. ref.: 303-1149





H.C.B-L1014

FORD REMOVER/INSTALLER

FORD 拆裝工具

- For replacing engine front cover inspection plate.
- Application:
Ford Mondeo / 2001 (10/2000-02/2007), Transit / 2000.5 (01/2000-05/2006), Transit / 2006.5 (After 04/2006)
- Applicable Engine:
2.0 L Duratorq-DI (Puma) Diesel Engine,
2.0 L Duratorq-TDCi (Puma) Diesel Engine,
2.0 L Duratorq-TDDi (Puma) Diesel Engine,
2.2 L Duratorq-TDCi (Puma) Diesel Engine,
2.3 L Duratec-HE (M14) Petrol Engine,
2.4 L Duratorq-DI (Puma) Diesel Engine,
2.4 L Duratorq-TDCi (Puma) Diesel Engine,
2.4 L Duratorq-TDDi (Puma) Diesel Engine,
3.2 L Duratorq TDCI (Puma) Diesel Engine.
- Land Rover OEM no. ref.: 303-679A.



H.C.B-A1645

NEW

LAND ROVER/ JAGUAR OIL FILTER WRENCH (Dr. 1/2", 90 mm x 15 FLUTES)

LAND ROVER/ JAGUAR 機油芯扳手 (Dr. 1/2" , 90 mm x 15 角)

- Size: 90mm x 15 Flutes x Dr. 1/2"
- Application:
Jaguar:
2010 and Newer 5.0L V8 Engines in the XJ, XJL, XK, XKR, XF, XFR and XKR.
Land Rover:
2010 and Newer 5.0L V8 Engines in the LR4, Ranger Rover and Range Rover Sport.



H.C.B-G1168

NEW

LAND ROVER V8 (4000 c.c.) BALL JOINT REMOVAL/ INSTALLATION TOOL KIT

LAND ROVER V8 (4000 c.c.) 球接頭拆裝工具組

- The C-clamp is forged, its material is SCM440 and hardness is HRC 38° - 42°
- Specially designed to remove & install the ball joint without removing any parts.
- Application: LAND ROVER V8 (4000 c.c.)





010

HWANG CHERNG BIN
Specialty Tools Inc.

保時捷修護工具

PORSCHE REPAIR TOOL





H.C.B-C1207

PORSCHE CAMSHAFT ALIGNMENT TOOL KIT

保時捷正時工具組

4 / 21.7 / 22.9 / 3.28'

- Application:
 - Porsche Boxster (2500 c.c., 1998),
 - Boxster (2700 c.c., 2000),
 - Boxster (3200 c.c., 2000),
 - 911 Carrera 4S (3600 c.c., 2002),
 - 996 (3400 c.c., 2002)
- OEM no. ref.: 9595, 9612, 9611, 9634, 9608, 9602

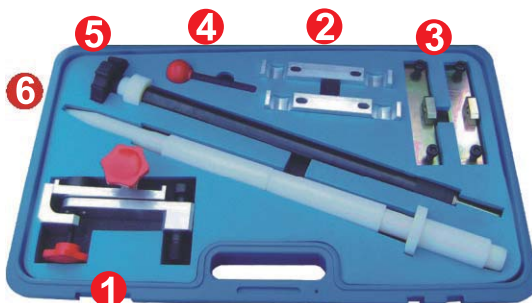

H.C.B-B1207

PORSCHE CAMSHAFT ALIGNMENT TOOL KIT

保時捷正時工具組

10 / 17.8 / 19.3 / 1.6'



H.C.B-A1207

PORSCHE CAMSHAFT ALIGNMENT TOOL KIT

保時捷正時工具組

- Application:
 - Porsche Boxster (2500 c.c., 1998),
 - Boxster (2700 c.c., 2000),
 - Boxster (3200 c.c., 2000),
 - 911 Carrera 4S (3600 c.c., 2002),
 - 996 (3400 c.c., 2002)

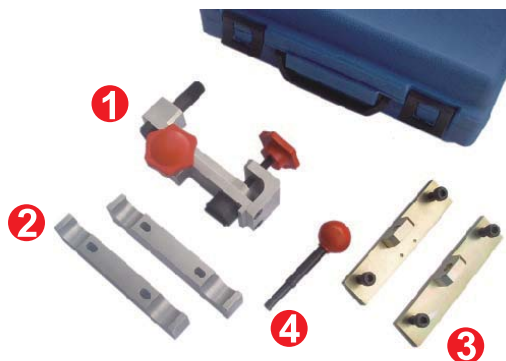

H.C.B-D1207 PORSCHE TIMING TOOL KIT (FOR 997)

保時捷正時工具組 (997 專用)

5 / 6.9 / 9 / 1.59'

- This tool kit should be used with H.C.B-C1207.
- Consists of :

Part No.	Description
H.C.B-D1207-1	Lock camshaft at Top-Dead-Center so that the cams can be accurately aligned.
H.C.B-D1207-2	Used to align crankshaft at Top-Dead-Center
H.C.B-D1207-3	Camshaft alignment gauge.
H.C.B-D1207-4	TDC locating pin



H.C.B-D1207-1



H.C.B-D1207-4



H.C.B-D1207-3

H.C.B-F1207 PORSCHE CAYENNE CAMSHAFT ALIGNMENT TOOL KIT (TURBO / TURBOS)

保時捷凱宴凸輪軸正時工具組 (渦輪 / 雙渦輪)

- A kit has two fixtures necessary to set camshaft timing on Porsche Cayenne equipped with the M97/01 V8 engine.
- This tool kit is necessary to establish TDC timing whenever the cam timing is disturbed for servicing of the cams, cylinder-head, timing chain or variable valve-timing cam phasers.
- Application: 2002 – 2008 Porsche Cayenne with V8 (NA or turbo) engine.

ITEM NO.	Description	OEM No.	Application:
E1207-2	Camshaft Gauges	9678	Cayenne
D1207-2	TDC Locating Pin	9595/1	
D1207-4	TDC Locating Pin		

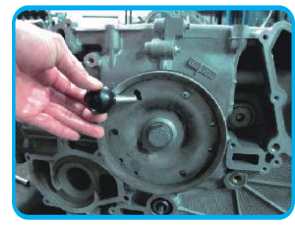

H.C.B-G1207 PORSCHE CAYENNE CAMSHAFT ALIGNMENT TOOL KIT

保時捷凱宴凸輪軸正時工具組

- This tool kit is designed to adjust the camshaft timing.
- Used to R & R crankshaft pulley bolt.

ITEM NO.	Description	OEM No.	Application:
G1207-1	Camshaft gauges	9678/1	2009 Panamera and later Cayenne DFI V8 (NA and turbo)
G1207-2	Camshaft gauges	9678	
G1207-3	Auxiliary chain tensioner	9683/1	Cayenne
G1207-4	Socket	9714	Cayenne after 2008
G1207-5	Pin for aligning crankshaft at Top-Dead-Center	9595/1	Cayenne
G1207-6	Pin for aligning crankshaft at Top-Dead-Center		

- Optional: H1207 (G1207 can be used on Panamera if combined with H1207)





H.C.B-H1207

PORSCHE PANAMERA AUXILIARY CHAIN TENSIONER

保時捷 PANAMERA 氣壓鏈條張緊器

- Size: M22 × P1.5
- Used to adjust the tension of the chain by using pneumatic power.



H.C.B-I1207

PORSCHE TIMING PIN

保時捷插銷



H.C.B-J1207

PORSCHE AUXILIARY CHAIN TENSIONERS (911/993/964/911 GT3 (996))

保時捷鏈條張緊器 (911/993/964/911 GT3 (996))

- Application: Model 911, 993, 964, 911 GT3 (996).
- Used to adjust the tension of the chain during disassembly, reassembly and timing.
- OEM no. ref.: 9401.



H.C.B-K1207

PORSCHE CAM TIMING TOOL (911/993)

保時捷正時工具組 (911/993)

- Used for holding camshafts when setting cam shaft timing.
- These locks set the exact camshaft timing during disassembly and reassembly.
- Application: 911/993.



H.C.B-L1207

PORSCHE CAM SPROCKET HOLDING WRENCH (911)

保時捷凸輪軸支撐扳手 (911)

- For holding and turning the camshaft.
- Application: Model 911 (1980-1994)
- OEM no. ref.: 9191



H.C.B-M1207 **PORSCHE DIAL IND, HOLDER KIT (911)**

保時捷錶組 (911)

- For setting engine timing.
- Application: 911



H.C.B-A2103-0516 **PORSCHE SOCKET (Spline (XZN) Dr. 1/2", M16 x 55 mm)**

保時捷套筒 (Spline (XZN) Dr. 1/2", M16 x 55 mm)

- For removing the manual transmission drain plug and Porsche Cayenne, Audi Q7 and VW Touareg brake caliper bolts.

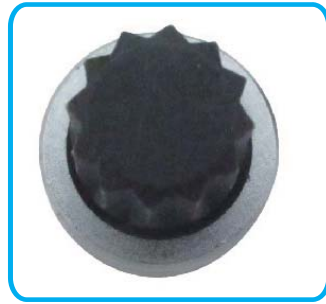

H.C.B-A1629 **NEW** **PORSCHE BRAKE CALIPER PAD SCREW SOCKET (Dr. 1/2", 10 POINTS)**

保時捷剎車卡鉗螺絲套筒 (Dr. 1/2", 10 角)

- Size: Dr. 1/2", 10 PT × 50 mm (Length).
- Application: For Porsche Cayenne and Audi Q7.





H.C.B-A1585

PORSCHE CAYENNE/AUDI Q7/VW TOUAREG HUB PULLER (EXTRA LARGER)

保時捷凱宴 /AUDI Q7/VW TOUAREG 輪軸拆卸器 (加大型)

- PCD (Pin Centre Diameter) from 110 mm to 160 mm
- Application:

Ø	Brand of car
112	Ford, Audi, Benz, BMW
114.3	Mitsubishi, Mazda, Toyota, Nissan, Honda
120	BMW, Opel
139.7	VW, Ford Transit, Benz
160	Ford Transit, Benz
110	Opel, Saab
118	Ducato, Peugeot, Citroen
120.65	Jaguar, GMC, Maseati, Chevrolet
127	GMC, Rover, USA cars, Jaguar
130	Benz, Audi, Prosche
140	Benz



H.C.B-B1585

NEW

PORSCHE CAYENNE /AUDI Q7/VW TOUAREG HUB PULLER (EXTRA LARGER) (P.C.D: 109 ~160 mm) (W/HYDRAULIC CYLINDER)

保時捷凱宴 /AUDI Q7/VW TOUAREG 輪軸拆卸器 (加大型) (P.C.D: 109~160 mm)(油壓)



Character:

- Allow the removal of hub with hydraulic cylinder or slide hammer.
- Special designed 17 tons hydraulic cylinder which is hollow with threaded hole can adjust the position depending on the threaded rod.
- An adaptor can attach to the front of the threaded rod which can easily push out the hub.
- Allow the combination with H.C.B-A3036 air pump to save time and labor.
- P.C.D (Pin Centre Diameter) from 109 mm to 160 mm.

Application:

Ø	Car Manufacturer
112	Ford, Audi, Benz, BMW
114.3	Mitsubishi, Mazda, Toyota, Nissan, Honda
120	BMW, Opel
139.7	VW, Ford Transit, Benz
160	Ford Transit, Benz
110	Opel, Saab
118	Ducati, Peugeot, Citroen
120.65	Jaguar, GMC, Maserati, Chevrolet
127	GMC, Rover, USA cars, Jaguar
130	Benz, Audi, Porsche
140	Benz

Specification:

No.	Description	Dimension	Qty'	Remark
1	Main Body	D: Ø149 × 113 L	1	d: Ø57 × 14 UNC
2	Slide Hammer Front Nut	D: Ø57 × 14 UNC × 36 L	1	d: 5/8" × 10 UNT
3	Slide Hammer	D: Ø100 × 168 L	1	d: Ø22, 10 Kg
4.	Slide Hammer Main Body	Ø65 × 688 L	1	D: 5/8" × 10 UNT
5.	Fixing Nut	d: 5/8" × 10 UNT	1	H24
6	Hollow Hydraulic Cylinder	17 tons	1	
7	Threaded Rod	D: Ø21 x 335 L	1	M20 x P2.5, H17
4	Pushing adaptor	D: Ø26 x 45 L	1	D: Ø17.4
P3&P4	Adaptor	Dr. 3/8"	1	



010
HWANG CHERNG BIN
Specialty Tools Inc.

保時捷專區

Porsche Tools

H.C.B-A1621

NEW

PORSCHE TIMING TOOL (987/981/997/911)

保時捷 正時工具 (987/981/997/911)

- Used to hold camshafts in timing position during sprocket installation.
- Used to turn the crankshaft when installing or removing the engine.
- Application: PORSCHE 987, 981, 997, 911
- OEM no. ref.: 9595/1, 9772, 9773, 9775

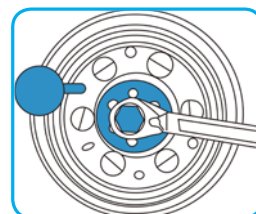
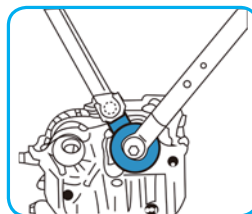

H.C.B-D2288

NEW

PORSCHE WHEEL LOCK SCREW SOCKET KIT (20 PCS)

保時捷防盜螺絲套筒組 (20 PCS)

- Material: SCM440 chrome plated.
- ABC-50, ABC-51, ABC-52, ABC-53, ABC-54, ABC-55, ABC-56, ABC-57, ABC-58, ABC-59, ABC-60, ABC-61, ABC-62, ABC-63, ABC-64, ABC-65, ABC-66, ABC-67, ABC-68, ABC-69
- OEM no. ref.: T10190



H.C.B tool car always sends immediate help to those who have problem repairing their vehicles.



PORSCHE TOOLS



010

HWANG CHERNG BIN
Specialty Tools Inc.

HONDA

修護工具

HONDA REPAIR TOOL



H.C.B-A1052

DOUBLE WISHBONE ALIGNMENT TOOLS (IMPROVEMENT) PAT. 196708

雙 A 臂羊角校正器 (改良型)

- Application:
All Mercedes-Benz, Mitsubishi Galant, Honda, and vehicles equipped with double wishbone suspension.
- Features:
With two spacers to adjust the angle.
On car maintenance without removing double wishbone.
Won't damage the hub bearing.
Fixed with C-type strong clamp having 10 tons hydraulic pressure.
Can be used on both front and rear double wishbone suspensions.
10 tons two-speed hydraulic pump makes the maintenance easy and accurate.
This is a time, money, and strength saver.
- NOTE:
It is recommended to use with H.C.B-A2057 simple mercury gauge.
- The hub bearing is often damaged by using a traditional alignment tool. Such maintenance costs the customers more and also waste time and energy resulted from the heavy and complicated accessories. But all above disadvantages will not happen on A1052, a newly-designed tool.
It makes more efficient to fix the bent out of shape on the double wishbone suspension system on vehicles.
This newly-designed accessory has honorably awarded T.W. PAT., approved by the Patent Office, H.C.B-A1052 is your best choice.

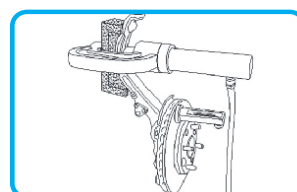
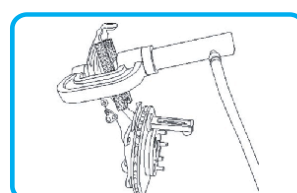

H.C.B-A1052-9

ACCESSORY USE ON MITSUBISHI GALANT ONLY

三菱 GALANT 專用配件



H.C.B-A2112

12 PCS TX-PLUS BITS KIT

12 PCS 5 角星型中空套筒組

- Content:
A. 9 pcs – 25 mm (L.), temper resistant TX-Plus bits.
(T10, T15, T20, T25, T27, T30, T40, T45, T50)
B. 1 pc - 1/4" magnetic bit holder.
C. 1 pc - ratchet handle.
D. 1 pc- 1/4" X 100 mm length bit holder.
- For the operation of inside 5-star screws with pin.
- T20 H: Applicable for screws on the MERCEDES-BENZ ATEGO and ACTROS plug-in pump, VW air flow sensor, HONDA idle speed engine adjustment and HONDA CR-V stereo anti-theft screws.
- Hexagon 6.3 mm = 1/4"





H.C.B-A2030

HONDA, ACURA & CR-V HARMONIC DAMPER PULLEY HOLDER

HONDA, ACURA & CR-V 正時皮帶盤支撐扳手

10 / 18 / 20.5 / 1.82'

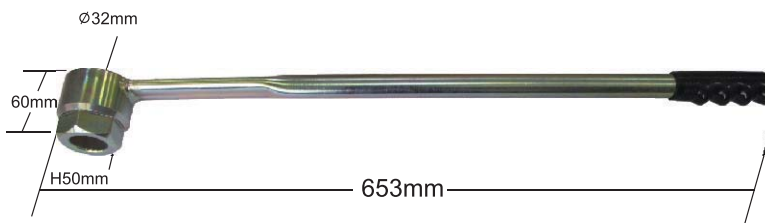

HONDA CR-V after year 1999

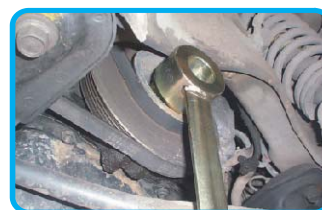

- For loosening the crankshaft pulley/ harmonic balancer bolt.
- The 50 mm hex. head armature slips can past the narrow space and slide right into the center slot on the pulley.
- Then slide the long bar onto the receiving end of the armature and lock it into position with the securing bolt.
- Length: 653 mm Hex head: 50 mm Hole: ϕ 32 mm

H.C.B-B2030

HONDA, ACURA & CR-V HARMONIC DAMPER PULLEY HOLDER

HONDA, ACURA & CR-V 正時皮帶盤支撐扳手

50 / 20.5 / 21.5 / 1.33'

- Application:
Honda Life D Turbo, Life 5D D, Life F 4WD, Life 5D 4WD, Life D, Life 5D F, Life G 4WD, Life F, Life F TB, Life D TB, Life 5D Minuet 4WD, Life 5D C, Life C, Life G

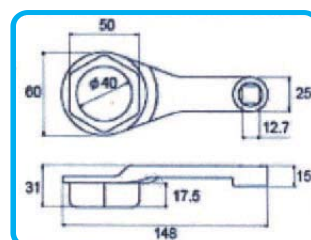



010
HWANG CHERNG BIN
Specialty Tools Inc.

HONDA 修護工具
HONDA Repair Tool

HONDA TOOLS

H.C.B-C2030 HONDA CRANK PULLEY HOLD WRENCH (Dr. 1/2")

HONDA 曲軸支撐扳手 (Dr. 1/2")

Usage:

- Crank pulley holding tool for Honda.
- Crank pulley can NOT be removed, if operate without H.C.B-C2030.

Application:

- The crank pulley is a 50 mm 2-faced flat type used in Honda cars.
- Can NOT be used on some NSX models.

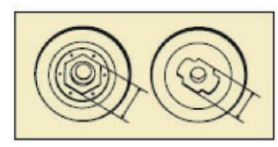
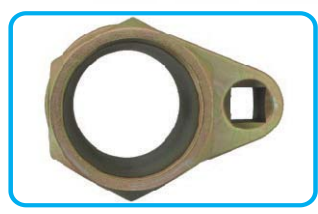

- 22 mm wrench or 1/2" sq spinner handle is necessary for this operation.

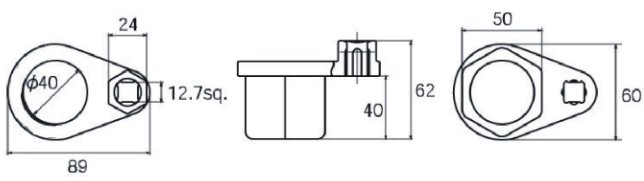

H.C.B-D2030 HONDA BELT PULLEY HOLDER

HONDA 皮帶盤固定器

- Designed to properly secure the pulley from rotating during R & R of crank bolt.
- The heights of both heads have two specifications suitable for different space, one is 30 mm and the other is 65 mm. The diameter of central hole is 35 mm.
- Application: Honda Life JB1~JB8, Civic, ODYSSEY etc.
- Total Length: 600 mm

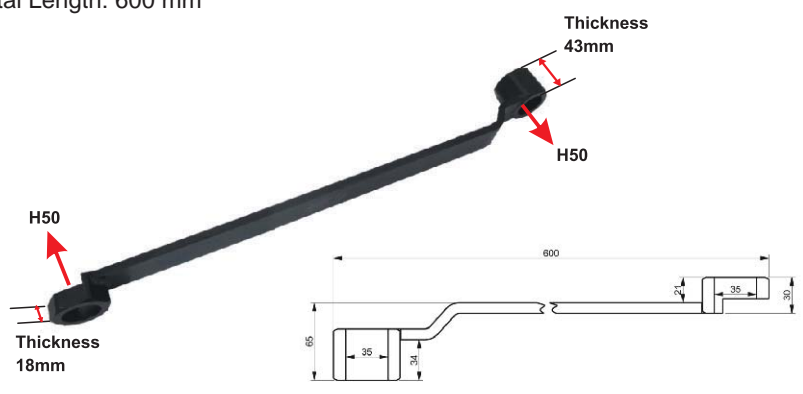

H.C.B-A2180 HONDA CR-V REAR TRAILING ARMS NUT SOCKET (Dr. 1/2", 10 POINTS, 20 mm)

HONDA CR-V 後游臂螺帽套筒 (Dr. 1/2", 10 角, 20 mm)

- For removing and replacing the retaining screws on rear trailing arms.
- Application : HONDA CR-V
- Length: 38 mm





H.C.B-A7002

HONDA LOWER CONTROL ARM BUSH REMOVER / INSTALLER (HYDRAULIC DRIVE) PAT. M 277669 USA PAT. PEN

HONDA 三角架鐵套拆裝工具組 (油壓)



K6 LOWER CONTROL ARM



K8 LOWER CONTROL ARM



K10 & CR-V LOWER CONTROL ARM BODY

■ **Features:**

Used in conjunction with H.C.B-B1129

On car maintenance.

For replacement of bushes on Honda cars.

Easy to use, and save time and money.

Application: HONDA CRV (before 2001), CIVIC K6 (1992), CIVIC K8 (JC) (1996), CIVIC K2 (carburetor), CIVIC K3 (injection)

■ **General introduction for bush:**

A flexible bush has an elastomeric element enclosed between an outer sleeve and a centre axis to ensure better road grip and stability. Makes driving more comfortable.

■ **Removal:**

Note: the window indicator is for reference during removal and installation.

STEP 1: Mount the tool on the lower control arm. Please refer to the removal illustration for guidance.

STEP 2: Check the sleeve and make sure cylinder, hydraulic pump are properly installed.

STEP 3: Remove the bush by pumping the hydraulic pump.

STEP 4: Extract the bush.

■ **Installation:**

NOTE: clean and lubricate the bush with wd-40 lubricant, recommended, before installation.

STEP 1: Put the bush and align it on the lower control arm.

STEP 2: Mount the tool on the lower control arm. Please refer to the installation illustration for guidance.

STEP 3: Install the bush by pumping the hydraulic pump.

STEP 4: Remove the tool and make sure the bush is properly installed on the lower control arm.

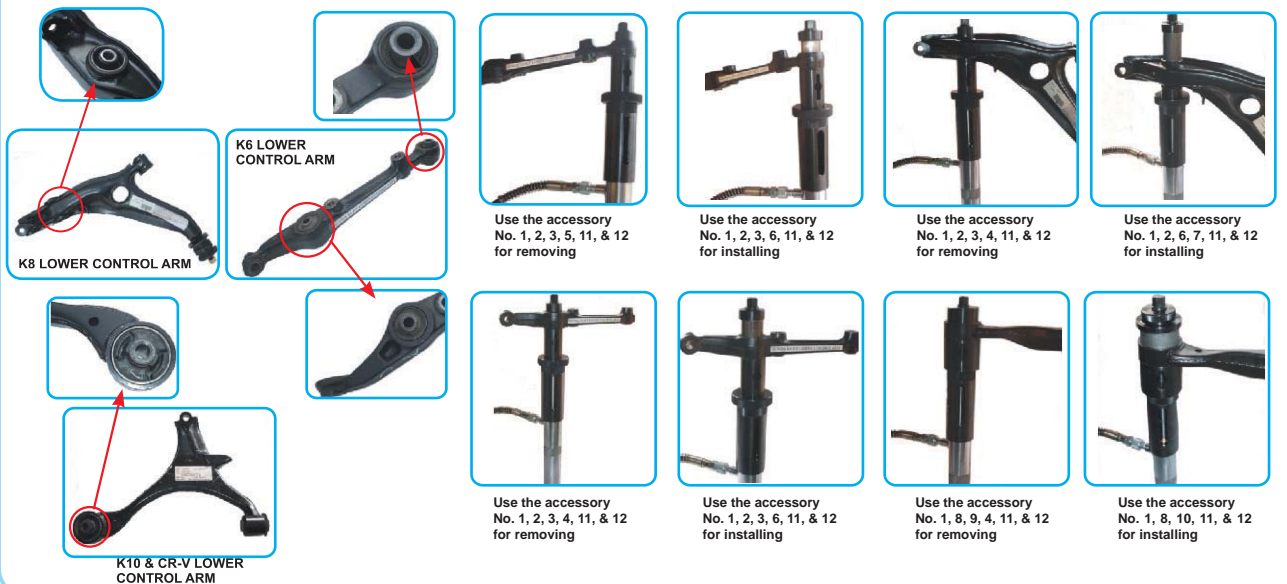

H.C.B-A7001 HONDA CR-V, K6 & K8 REAR TRAILING ARM BUSH REMOVER / INSTALLER JP PAT. 3126495 PAT. M296812

HONDA CR-V, K6 & K8 後游臂鐵套拆裝工具組

5 / 25.5 / 26.5 / 2.31'

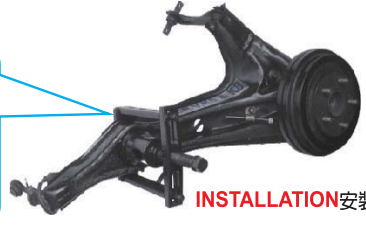

- Application:
 - HONDA: CIVIC (1988-2000)
 - DEL SOL (1993-1997)
 - CR-V (K6/K8) (1997-2002/8)
 - ACURA: Integar (1994-2001)
 - LANCER VIRAGE (after 2001)
- Service completely performed on the car.
- A hydraulic press is not needed to remove the old bushing or install the new one.
- Service time is only 10 minutes per side, you can save time, labor and money.
- Shifting hook design could adjust the size.



TIPS FOR METAL BUSH

- ▲ A flexible bush has an elastomeric element enclosed between an outer sleeve and a center axis, so as to ensure better road grip and stability.
- ▲ Makes driving more comfortable and safe.

- 車上拆裝, 免拆下後仰角。
- 免拆排氣管, ABS 剎車線。
- 您賺錢最佳的利器。

H.C.B-A7003 HONDA ACCORD UPPER CONTROL ARM BUSH REMOVER / INSTALLER (AFTER YEAR 2004) USA PAT.

HONDA 雅哥 (2004 年後) 上三角架鐵套拆裝工具組



- The best tool for the replacement of Honda Accord upper control arm bush.
- On car maintenance.
- Won't damage the parts close to bush during the maintenance.
- Window indicator for reference while removing and installing the bush.
- Can be used easily and quickly which saves time and money.
- Application: Honda Accord after year 2004

General introduction for bush

- A flexible bush has an elastomeric element enclosed between an outer sleeve and a center axis to ensure better road grip and stability.
- It makes driving more comfortable



Removal:

NOTE: The window indicator is for reference during removal and installation.

- STEP 1: Mount the tool on the upper control arm. Please refer to the removal illustration for guidance.
- STEP 2: Check the sleeve and make sure they are properly installed.
- STEP 3: Remove the bush by rotating the nut with wrench or socket.
- STEP 4: Extract the bush.



Installation:

NOTE: Clean and lubricate the bush with WD-40 lubricant, recommended before installation.

- STEP 1: Put the bush and align it on the upper control arm.
- STEP 2: Mount the tool on the upper control arm. Please refer to the installation illustration for guidance.
- STEP 3: Install the bush by rotating the nut with wrench or socket.
- STEP 4: Remove the tool and make sure the bush is properly installed on the upper control arm.





H.C.B-A7004

ACCORD AIR-CONDITIONER PANEL EXTRACTOR

雅哥冷氣面板拆卸器

- Application: ACCORD 2003



H.C.B-A7005

HONDA BELT TENSIONER WRENCH

喜美 8 代 (1800 c.c., 2000 c.c.) 皮帶張力器調整扳手

- Application: HONDA CIVIC VIII (1800 c.c., 2000 c.c.)
2006 HONDA CIVIC 4D 1.8 L 1799 c.c. inline four cylinder engine
2006 HONDA CIVIC 4D 2.0 L 1998 c.c. inline four cylinder engine

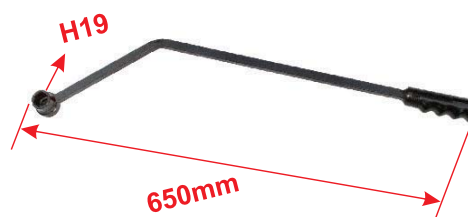

H.C.B-B7005

HONDA BELT TENSIONER WRENCH

喜美 8 代 (1800 c.c., 2000 c.c.) 皮帶張力器調整扳手

- Application: Honda new car

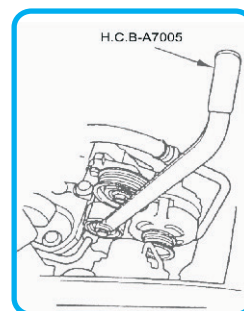
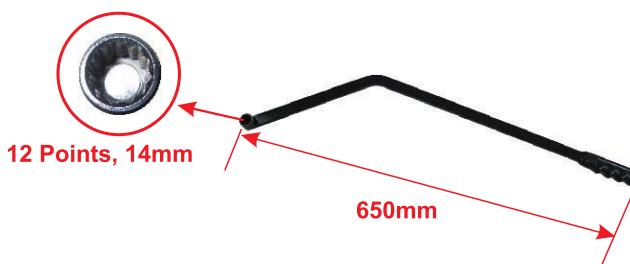

H.C.B-A7006

UNIVERSAL FLYWHEEL HOLDING TOOL

通用型飛輪阻擋器

- For fixing flywheel.
- Torque wrench is allowed.
- In order to prevent transmission clutch spring washer from rotating, it's necessary to lock the plate.
- Application: Honda, Ford, Mitsubishi, Toyota....., etc.

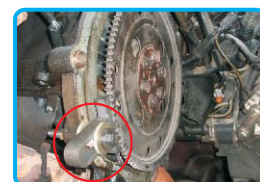

H.C.B-A7007

HONDA (K10 / CR-V) LOWER CONTROL ARM BUSH REMOVER / INSTALLER

HONDA (K10 / CR-V) 三角架鐵套拆裝工具組

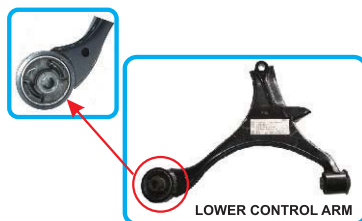

■ FEATURES

- On car maintenance.
- For the replacement of bushes on Honda cars.
- Easy to use and save time and money.
- Application: Honda Ferio / K10 (after 01), CRV 2.0 (2002-2006), Element (2003-2006), Honda Pilot (After 2003), Odyssey (After 2005), Ridgeline (After 2006), Acura MDX (2000-2006)

■ GENERAL INTRODUCTION FOR BUSH

- A flexible bush has a blastomeric element enclosed between an outer sleeve and a centre axis to ensure better road grip and stability.
- Makes driving more comfortable.

■ REMOVAL

NOTE: THE WINDOW INDICATOR IS FOR REFERENCE DURING REMOVAL AND INSTALLATION.

- Step 1: Mount the tool on the lower control arm. Please refer to the removal illustration for guidance.
Step 2: Remove the bush by wrench.
Step 3: Extract the bush.

■ INSTALLATION

NOTE: CLEAN AND LUBRICATE THE BUSH WITH WD-40 LUBRICANT, RECOMMENDED, BEFORE INSTALLATION

- Step 1: Put the bush and align it on the lower control arm.
Step 2: Mount the tool on the lower control arm. Please refer to the installation illustration for guidance.
Step 3: Install the bush by wrench.
Step 4: Remove the tool and make sure the bush is properly installed on the lower control arm.

H.C.B-A7008

HONDA ACCORD AXLE BALL JOINT REMOVAL / INSTALLATION TOOL KIT

HONDA 雅哥仰角球頭拆裝工具組

- The C-clamp was forged, and its material is SCM440, hardness is HRC 38° - 42°.
- On car maintenance.
- Especially designed to remove and install the ball joint on car to save time and labor.



Extraction

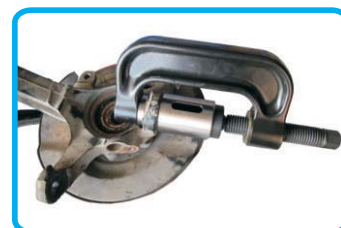

Installation





H.C.B-A7009

ON CAR

HONDA (CIVIC 7) (FERIO 1700 c.c. K10) FRONT AXLE BALL JOINT REMOVAL / INSTALLATION TOOL KIT

HONDA (CIVIC 7) (FERIO 1700 c.c. K10) 前仰角球接頭拆裝工具組

- The C-clamp was forged, and its material is SCM440, hardness is HRC 38° - 42°
- On car maintenance.
- Special design to remove & install the ball joint without removing any parts.
- Application: HONDA CIVIC 7 FERIO (1700 c.c. K10)

- 此本體是鍛造，材質是SCM440硬度是HRC 38°~42°
- 可於車上修護
- 特別的設計可安裝與拆卸HONDA(CR-V)第一代前下球接頭拆裝器而不用拆卸到任何零件
- 適用車種: CIVIC7 FERIO (1700 c.c./K10)

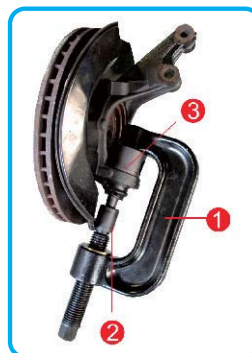

Extraction

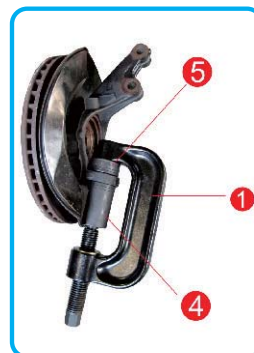

Installation

H.C.B-A7010

HONDA WIPER SPRINKLER HEAD ADJUSTER

HONDA 兩刷調整器

- Used to adjust wiper sprinkler head angle.
- 用於調整雨刷噴水頭角度工具

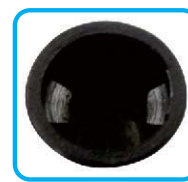

H.C.B-A7011 HONDA ADJUSTABLE FUEL TANK LID REMOVER / INSTALLER

HONDA 燃油濾清器鎖附螺帽拆裝工具

- Firstly, check the model and year of the car.
- Loosen butterfly screws, and then follow the scale form to position the fixing legs to fit the lock ring.
- Loosen and tighten the butterfly screws only by hand. (Do not use tool to adjust butterfly screws)
- Use 1/2" square drive tool to turn .The torque turning force is 120 Nm.
- ※ It may cause spare part or this tool damaged if you do not follow the scale position when repair.

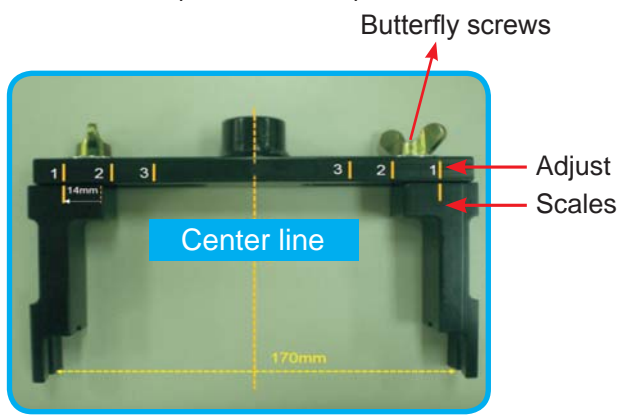
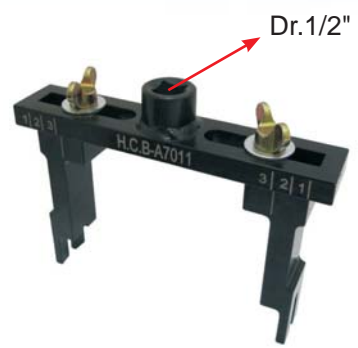

Scale position	1	2	3
Application	After 2006 CIVIC After 2011 CRZ After 2012 CIVIC Lock ring: Ø170 mm	After 2013 SUPER-CRV After 2013 ACCORD Lock ring: Ø155 mm	After 2007 CRV After 2008 ACCORD After 2009 FIT Lock ring: Ø138 mm

H.C.B-A7012 HONDA FRONT / REAR AXLES WHEEL BEARING REMOVAL / INSTALLATION TOOL KIT

HONDA 前 / 後輪軸培林拆裝工具組

- This tool is designed to remove / install the front and rear axle wheel bearings without extracting hub to save time and labor.
- On car maintenance.
- Application:



Model	Year	Position	Bearing Model	Bearing- (outside diameter)
FIT	2008~2012	Front Wheel	44300-TF0 951	74
CIVIC	8 th generation :2006~2012	Front Wheel	44300-TS4 951	78
CRV	2003~2006	Rear Wheel	44300-SAA 003	73
CRV	2 nd generation :2003~2006	Front Wheel	44300-S9A 003	84
CRV	3 rd generation :2007~2011	Front Wheel	44300-SJK J01	91



Removal



Installation



H.C.B-A7013

HONDA SUBFRAME BUSH REMOVAL AND INSTALLATION TOOL KIT (HYDRAULIC, 3/8" ADAPTOR)

HONDA 三角架鐵套拆裝工具組 (油壓, 3/8" 接頭)

- Removal / installation tool kit for bushes on Honda subframe.
- This kit is designed to operate on car.

Application:

Model	Year	Bush model	Bush Outer Diameter	
ACCORD	2003~2007	51391-5DB A01	Ø 74	3000 c.c
CRV	CR-V II	51391-S7A 801	Ø 65	
CIVIC	2006~2011	51391-SNA 305	Ø 65	



H.C.B-A7014

HONDA CIVIC R18A1 CRANKSHAFT REAR OIL SEAL INSTALLATION TOOL KIT

HONDA CIVIC R18A1 曲軸後油封安裝工具 (8/9 代)

- To prevent the crankshaft rear oil seal from damaged when installing it.





010

HWANG CHERNG BIN
Specialty Tools Inc.

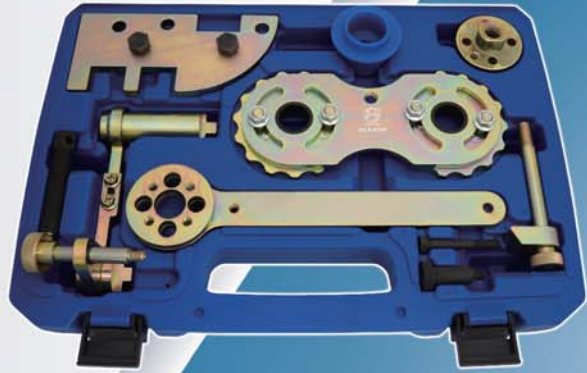

VOLVO

修護工具

VOLVO REPAIR TOOL



H.C.B-A1355

VOLVO BALL JOINT REMOVER

VOLVO 球接頭拆卸器

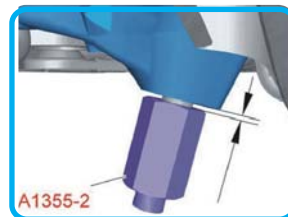
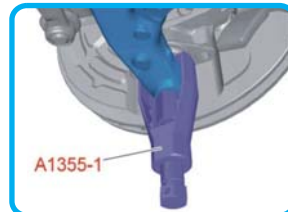

- For removing lower control arms, ball joints and suspension parts.
- Application: V70 (00-08), V70 XC (01-) / XC70 (-07), S60, S80 (-06) · XC90.
- Sizes of nuts: M12 × P1.75, M14 × P2.0

H.C.B-A1358

VOLVO DIFFERENTIAL SEALING NUT WRENCH

VOLVO 差速器密封環螺帽扳手

- Application: XC90, V70 (00-08), V70 XC (01-) / XC70 (-07), S60, 850, S70, V70 (-00), V70 XC (-00), 940, 940 SE, 960, S80 (-06).

- VOLVO OEM no. ref.: 9995371



H.C.B-A1359

VOLVO DIESEL FILTER WRENCH

VOLVO 柴油濾芯扳手

- Application: V70 (08-), XC70 (08-), S80 (-06), XC90, V70 (00-08), V70 XC (01-) / XC70 (-07), S60, C30, C70 (06-), S40 (04-), V50, S80 (07-).

- Engine: D4204T11, D4204T14, D4204T20, D4204T4, D4204T5, D4204T8, D4204T9, D5204T2, D5204T3, D5204T7, D5244T, D5244T10, D5244T11, D5244T12, D5244T14, D5244T15, D5244T16, D5244T17, D5244T18, D5244T19, D5244T2, D5244T20, D5244T21, D5244T22, D5244T23, D5244T3, D5244T4, D5244T5, D5244T6, D5244T7.

- VOLVO OEM no. ref.: 9997084.



H.C.B-A1360

VOLVO FUEL TANK LOCKING RING TOOL

VOLVO 油箱蓋拆裝器

- For removing and installing the fuel tank lid.
- Application: V70 (00-), S80, XC90, S60, V70 XC (01-) / XC70.
- Engine: B5204T4, B5204T5, B5234T3, B5234T7, B5244S, B5244S2, B5244S6, B5244SG, B5244SG2, B5244T3, B5244T4, B5254T2, B6284T, B6294S, B6294S2, B6294T, B6304S3, B8444S, D5244T, D5244T2, D5244T3, D5252T MSA 15.8 and B5204T3.
- VOLVO OEM no. ref.: 9995720.



H.C.B-A1361

VOLVO CYLINDER HEAD REMOVER

VOLVO 汽缸蓋拆卸鉗

- This tool is used for removing cylinder head.
- Application: V70 (08-), XC70 (08-), S80 (-06), XC90, V70 (00-08), V70 XC (01-) / XC70 (-07), S60, C30, C70 (06-), S40 (04-), V50, S40 (-04), V40, 850, C70 Coupe (-02), C70 Conv (-05), S70, V70 (-00), V70 XC (-00), 960, S90, V90, S80 (07-).
- VOLVO OEM no. ref.: 9995670.



H.C.B-A1362

VOLVO TANK LID REMOVER/INSTALLER

VOLVO 油箱蓋拆裝器

- This tool is used for removing and installing the fuel tank lid.
- Application: 240, S40 (-04), V40, 850, C70 Coupe (-02), C70 Conv (-05), S70, V70 (-00), V70 XC (-00).
- Engine: B4184S, B4204S, B5202FS, B5204FS, B5204FT, B5204T2, B5204T3, B5234FS, B5234FT, B5234T2, B5234T3, B5234T4, B5234T5, B5234T6, B5234T8, B5244S, B5244S2, B5244T, B5244T2, B5252FS, B5254FS LH 3.2, B5254FS M 4.3, B5254FS M 4.4, B5254S DENSO, B5254T, D5252T MSA 15.7.
- VOLVO OEM no. ref.: 9995485.

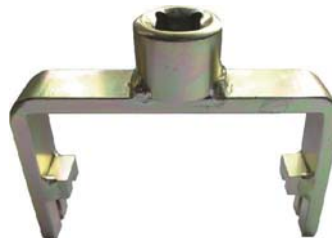



H.C.B-A1378

VOLVO FUEL PUMP TANK LID WRENCH

VOLVO 油箱蓋拆卸器

- Application: V70 (08-), XC70 (08-), C30, C70 (06-), S40 (04-), V50, S80 (07-).
- Engines: B4164S3, B4184S11, B4184S8, B5244S4, B5244S5, B5254T3.
- VOLVO OEM no. ref.: 9997093.



Fuel Pump Tank Lid

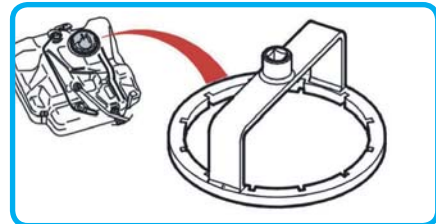

H.C.B-A1381

VOLVO FRONT STRUT LOWER NUT WRENCH

VOLVO 避震器拆装套筒

- Application:
 1. C70 Coupe (-02), C70 Conv (-05), S70, V70 (-00), V70 XC (-00), 850
 2. XC90, V70 (00-08), V70 XC (01-) / XC70 (-07), S60, 850, C70 Coupe (-02), C70 Conv (-05), S70, V70 (-00), V70 XC (-00), S80 (-06).

- VOLVO OEM no. ref.: 1-9995469
2-9995468



H.C.B-A1382

VOLVO IDLER WRENCH

VOLVO 惰輪扳手

- Application: S80 (-06), XC90, V70 (00-08), V70XC (01-) / XC70 (-07), S60, C30, C70 (06-), S40 (04-), V50, S40 (-04), V40, C70 Coupe (-02), C70 Conv (-05), S70, V70 (-00), V70 XC (-00)

- VOLVO OEM no. ref.: 9997109.



H.C.B-A1306 VOLVO COMPUTER CONTROL BOX REMOVER/INSTALLER

VOLVO 電腦控制模組拆裝器

- Easy and safe to remove or install the computer control box.
- Application: VOLVO S40, S60, S/V70, S80, XC90.
- VOLVO OEM no. ref.:** 9995722.



Removal :



Step 1



Step 2



Step 3



Step 4

Installation:



Step 1



Step 2



Step 3



Step 4

H.C.B-A1308 VOLVO SERPENTINE BELT TOOL

VOLVO 惰輪調整扳手

- For turning the idler and replace serpentine belt with square head at the front.
- Application: VOLVO autos after 1995.



H.C.B-A1069 VOLVO CAMSHAFT/ CRANKSHAFT ALIGNMENT TOOL

VOLVO 正時工具組

3 / 19.9 / 20.1 / 2.39'

- For alignment of the cam and crankshafts. Enable the correct installation of the camshafts with the cam cover.
- Application: VOLVO
Engines: B41XX, B42XX, B52XX, B62XX, B63XX.
Models: 700, 800, 850, 900, 960, C70 Coupe and Conv, S40, S60, S70, S80, S90, V70-2000 V70XC, XC70, V90, XC90.
- VOLVO OEM no. ref.:** 9995451/ 9995454.

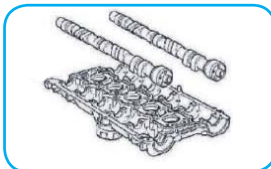

Use specified seal glue on the flange.

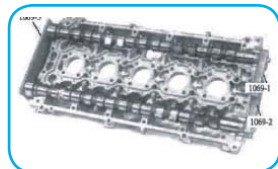

The crankshaft locking hole.

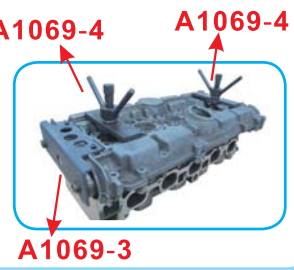

A1069-4

A1069-4

A1069-3



H.C.B-A1395

VOLVO CRANKSHAFT PULLEY HOLDING TOOL

VOLVO 曲軸皮帶盤支撐扳手

- Used to counter-hold the crankshaft pulley to release and tighten the center bolt.
- Application: S80 (98-06), S70/V70 (97-07), XC70 (02-07), S60 (00-09), C30 (06-09), C70 (98-09), S40/V40 (97-09), V50 (04-09), XC90 (02-09).
- VOLVO OEM no. ref.: 9995433.



H.C.B-A1406

LAND ROVER /JAGUAR/VOLVO(T6) CAMSHAFT ALIGNMENT TOOL KIT

LAND ROVER /JAGUAR/VOLVO(T6) 凸輪軸正時工具組

- Special design to align the engine camshaft and crankshaft position, and correct into the side cover.
- Application: Land Rover, Jaguar, VOLVO S80, XC90, XC60, XC70 3.0T, 3.2 (T6 Engine) since 2007
2008 - 2012 Land Rover - LR2/ 2011 - 2013 Volvo - S60
2012 - 2013 Volvo - S60 R/ 2007 - 2013 Volvo - S80
2008 - 2010 Volvo - V70/ 2010 - 2013 Volvo - XC60
2012 - 2012 Volvo - XC60 R/ 2008 - 2013 Volvo - XC70
2007 - 2013 Volvo - XC90/ 2012 - 2013 Volvo - XC90 R



- VOLVO OEM no. ref.: 9997257 / 9997261 / 9997263 / 9997264 / 9997271 / 9997272 / 9997266 / 9997267.

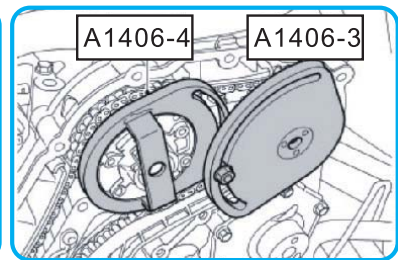
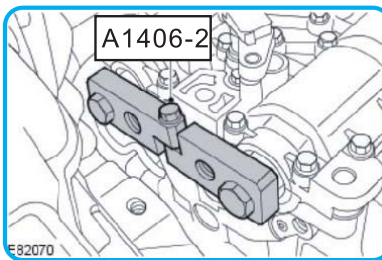
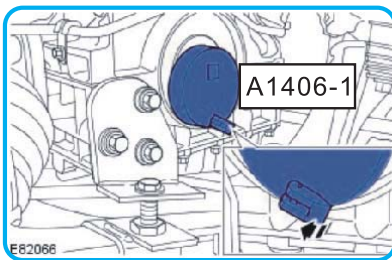

H.C.B-A1427

VOLVO DIESEL PUMP TANK LID WRENCH

VOLVO 柴油幫浦油箱蓋拆裝器

- For removing and installing the metal fuel tank lid.
- Application: S60 Cross Country, S60L, S80 (07-), V60, V60 Cross Country, V70 (08-), XC60, XC70 (08-), S60 (11-).
Engine: B4164T2, B4164T3, B4204T6, B4204T7, B5254T5, B6304T4, B6324S4, B6324S5, D4162T, D5204T2, D5204T3, D5244T10, D5244T11, D5244T15, D5244T17, B4164T.
- VOLVO OEM no. ref.: 9997418.

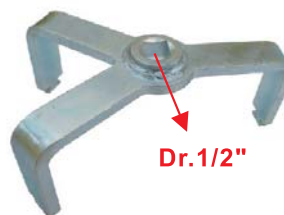

H.C.B-A1447 VOLVO FRONT SUSPENSION SHOCK ABSORBER SPRING COMPRESSOR

VOLVO 前懸吊系統避震器彈簧壓縮工具

- To separate the sub-frame and shock absorber.
- Application: VOLVO S80 (1999-2006)
S60 (2001-2010)
XC60 (2009~)
XC70 (2002-2007)
V70 (2000-2007)
XC90
- VOLVO OEM no. ref.: 9997256.



H.C.B-A1545 VOLVO TIMING TOOL KIT(T4/ T5)

VOLVO 正時工具組 (T4/ T5)

- To adjust and fix the angle of camshaft and crankshaft.
- Application: VOLVO V4 1.6 L, 2.0 L, T4, T5 engine.

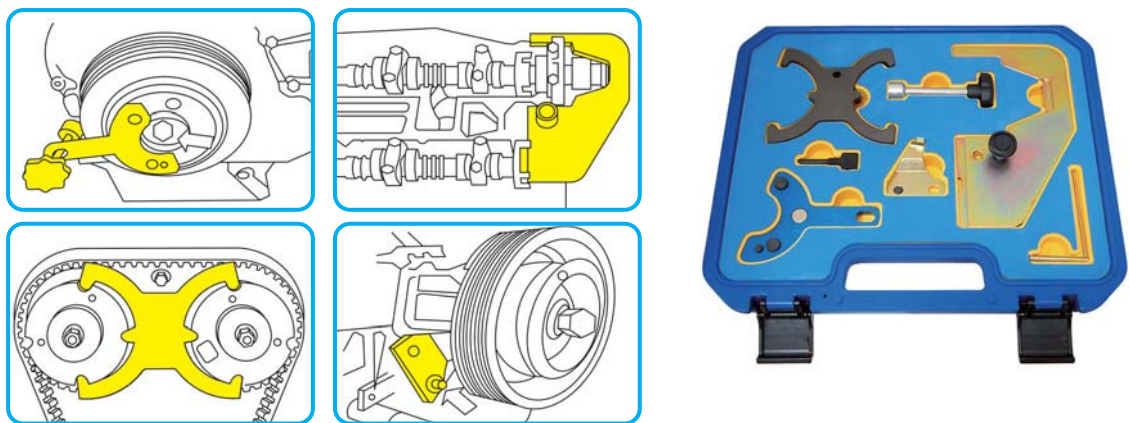

H.C.B-A1564 VOLVO CRANKSHAFT PULLEY HOLDER

VOLVO 曲軸支撐扳手

- Designed for holding crankshaft in place.
- Application: 200, 300.4, 700, 900, 940, 940 SE, 960
- Engine: B200E, B204E, B204FT, B230E, B230F, B230FT, B234F, B234G
- VOLVO OEM no. ref.: 9995284.





H.C.B-A1619

NEW

VOLVO B4204 (8-SPEED TRANSMISSION) CAMSHAFT ALIGNMENT TOOL KIT

VOLVO B4204 (8 速變速箱) 正時工具組

- Special design to align the engine camshaft and crankshaft position, and to get them into the side cover correctly.

■ Application:

VOLVO B4204 engine (8-Speed Transmission).

Volvo S60 (2011~present)

Volvo S60L (2007~present)

Volvo S80 (2007~present)

Volvo V40 (2013~present)

Volvo V40 Cross Country (2008~present)

Volvo V60 (2008~present)

Volvo V60 Cross Country (2008~present)

Volvo V70 (2008~present)

Volvo XC60 (2008~present)

Volvo XC70 (2008~present)

Volvo XC70 (2016)

- **VOLVO OEM no. ref.:** 9997490 Position setting
9997493 Puller
9997495 Counterhold
9997496 Drift
9997497 Counterhold

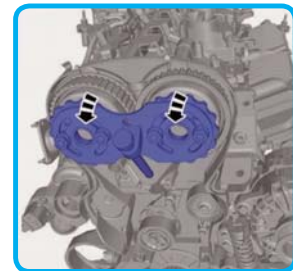

H.C.B-A1638

NEW

VOLVO / FORD / CHRYSLER / DODGE DUAL-CLUTCH TRANSMISSION REMOVAL/INSTALLATION TOOL

VOLVO / FORD / CHRYSLER / DODGE 雙離合器變速箱拆裝工具

- To remove and install the dual-clutch transmission.
- Special design to fix, turn and take out the dual-clutch.

■ Application:

Volvo: C70 (06-), S40 (04-), S60 (11-), S80 (07-), S80L, V40 (13-), V40 Cross Country, V50, V60, V70 (08-), XC60, C30

Volvo Engine: B4164T, B4164T2, B4164T3, B4204S3, B4204S4, B4204T6, B4204T7, D4162T, D4204T, with Power Transmission: MPS6

Ford: Focus (04-), C-Max, S-Max, Galaxy, Mondeo (07-), Kuga (13-).

Chrysler: Sebring.

Dodge: Avenger, Journey.

- **OEM no. ref.:** VOLVO: 9997435/ FORD: 308-763



H.C.B-A1660

NEW

VOLVO HEATER BLOWER REMOVAL/INSTALLATION TOOL

VOLVO 冷氣鼓風機拆裝工具

- Tool for installing and removing the heater fan and the blower motor assembly.

- Application: S60 Cross Country, S60L, S80 (07-), S80L, V60, V60 Cross Country, V70 (08-), XC60, XC70 (08-), S60 (11-)

■ Application:

S60 (S-60) T5 Sedan (2.5L L5 Turbo) - 2012 2013

S60 T6 (T-6) Sedan (3.0L L6 Turbo) - 2011 2012 2013

S80 (S-80) Sedan (4.4L V8) - 2007 2008 2009 2010

S80 3.2 Sedan (3.2L L6) - 2007 2008 2009 2010 2011 2012 2013

S80 T6 Sedan (3.0L L6 Turbo) - 2008 2009 2010 2011 2012 2013

V70 (V-70) 3.2 Wagon (3.2L L6) - 2008 2009 2010

XC60 (XC-60) 3.2 Sport Utility (3.2L L6) - 2010 2011 2012 2013

XC60 3.2 R-Design (R Design, RDesign) Sport Utility (3.2L L6) - 2011

XC60 T6 Sport Utility (3.0L L6 Turbo) - 2010 2011 2012 2013

XC60 T6 R-Design Sport Utility (3.0L L6 Turbo) - 2010 2011 2012 2013

XC70 (XC-70) 3.2 Wagon (3.2L L6) - 2008 2009 2010 2011 2012

XC70 T6 Wagon (3.0L L6 Turbo) - 2009 2010 2011 2012 2013

- **VOLVO OEM no. ref.:** 9997284





010

HWANG CHERNG BIN
Specialty Tools Inc.

一般修護工具 底盤

GENERAL CHASSIS REPAIR TOOL

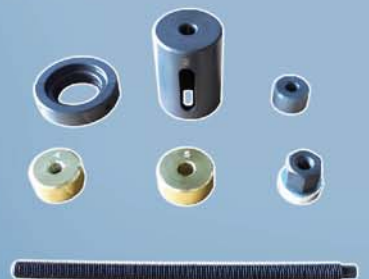
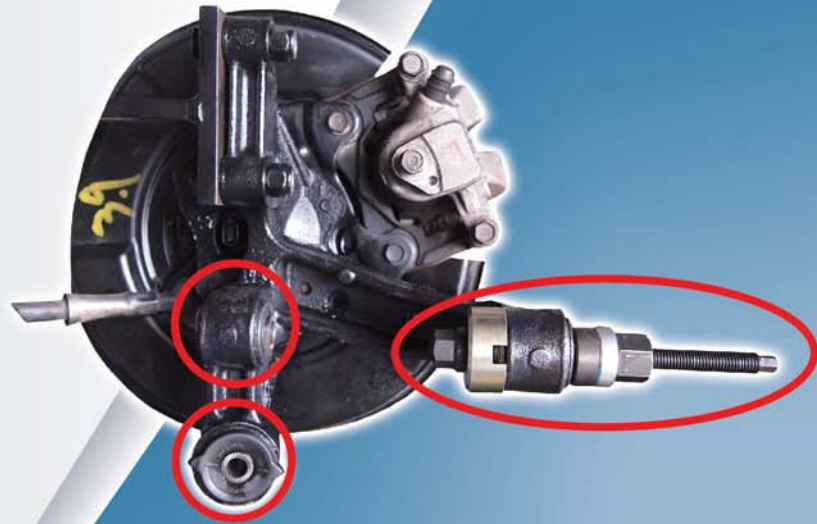



H.C.B-A1005

ROLLER STITCHER PAT.155302

輪胎補胎修補器 (專利品)

- Durable steel handle and bearing inside make operation easier.
- N.W.: 0.35 KGS



H.C.B-A1006

ROLLER STITCHER PAT.155302

輪胎補胎修補器 (專利品)

- Durable steel handle and bearing inside make operation easier.
- N.W.: 0.31 KGS



H.C.B-A1007

ANGLE ADJUSTER

仰角校正器



Step 1



Step 2



Step 3



Step 4 with mercury gauge

H.C.B-A1007-8-6

6 HOLES CONVEX PLATE

六孔凸型盤

- With 4 pcs alignment plates.
- Hydraulic function.
- Application: most of cars.
- The purpose of wheel alignment is to reduce tire wear, improve fuel economy and handling, while increasing driving enjoyment and safety by properly adjusting the angles of the wheels, suspension system, and steering system.
- Combined with H.C.B-A2057.



OPTIONAL : H.C.B-A1007-8-6 FOR TOYOTA

H.C.B-A2311

NEW

WHEEL ALIGNMENT

四輪定位儀

- Fits 14" to 22" wheels.
- Quick alignment check and easy to use.
- Adjustable to any surface.



H.C.B-A2057

SIMPLE MERCURY GAUGE (6°)

簡易式水銀錶 (6°)

25 / 10.5 / 11.5 / 1.67'

- It has a simple leveling adjustment of +/-6°.
- Housed in a durable non-magnetic casting with a magnetic head that attaches firmly to rotors or spindles.
- It's a time and money saving device which returns a strut to its original camber after repair or replacement.
- Measure camber change before reinstalling and alignment heads during camber kit installation.
- Check the amount of camber change before reinstalling tire and wheel assemblies on trucks receiving offset alignment bushings.



H.C.B-A2175

GAUGE FOR CAMBER, CASTER & KING PIN

大王銷檢查表

6 / 21 / 22 / 1.6'

- Specifications:
Dimension: 230 mm in length x 90 mm in width
Camber: -5° ~ +5°
Caster: -3° ~ 0 ~ 10°
King Pin: 0° ~ 16°
Weight: 1.7 KG
- Conjunction with TURNTABLE, you can easily and rapidly measure correct angles of CAMBER, CASTER and KING PIN and a rotation angle of STEERING WHEEL.
Moreover, when the angle of CAMBER and CASTER has been changed simultaneously, you can get the best suited WHEEL ALIGNMENT angle adjusted by the manufacturer because you can read the change of each angle at the same time.

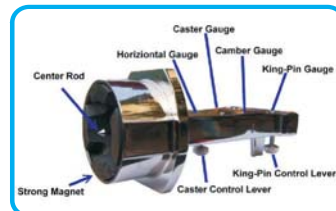

H.C.B-A1060

SSANGYONG BUSH EXTRACTION/ INSTALLATION TOOL KIT

中華昇陽三角架鐵套拆裝工具組

- Used for R&R of rear wheel bearing located in wheel carrier.
- This tool can also be used for installing the rear axle shaft flange.
- Application: SSANYOUNG.
- N.W.: 6.4 KGS G.W.: 6.6 KGS





H.C.B-A2202

FENDER ROLLER TOOL

輪弧擴張器

2 / 17 / 18 / 2'

- Enlarge fender for replacing larger and wider tire.
- Fender rolling for dent car.
- Universal type for 3, 4, 5 lugs wheel.

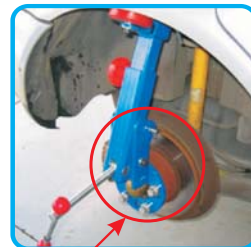

H.C.B-A2202

H.C.B-A1026

AXLE BEARINGS EXTRACTION/ INSTALLATION TOOL KIT

仰角培林拆裝組

4 / 21.2 / 23.2 / 1.64'

- To install and remove the outer races from hub (wheel) bearings as well as for hub press-fitting. This screw-type puller eliminates the need of presses and slide hammers.
- Application: BENZ, BMW, TOYOTA, FORD, MITSUBISHI.....etc.

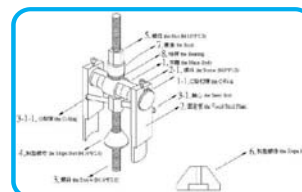
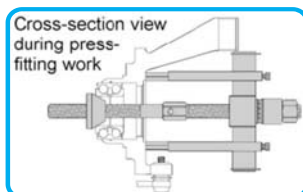
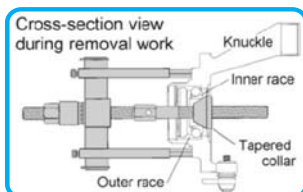
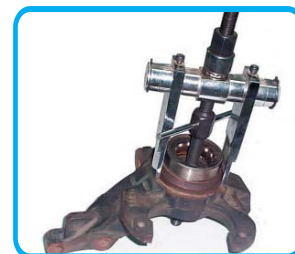

This puller is designed exclusively for unit-Type bearing races (used in most of today's vehicles). (Hub insertion is also possible with detachable types).

H.C.B-A1056

SOCKET TOOL (FOR FWD ONLY)

中華百利 800 c.c. 四輪傳動專用套筒

- Socket reversed for the use of FWD to remove and install the hub.
- N.W.: 0.56 KGS



H.C.B-A1057 NISSAN, SUZUKI SOCKET TOOL (FOR FWD ONLY)

NISSAN, SUZUKI 四輪傳動專用套筒

- Socket reversed for the use of FWD to remove and install the hub.
- Application: NISSAN, SUZUKI
- N.W.: 0.6 KGS



H.C.B-A1084 MITSUBISHI WAGON (CANTER) WHEEL BALANCE ADJUSTER

三菱卡車 (堅達) 校輪盤

- This tool is designed to adjust bigger wheel that the wheel balancer's original option can't do.

Item No.	d (mm)	Applicable Balancers	Applicable Car
H.C.B-A1084-A	185x180	CEMB, HOFFMAN, FAIP, CORGHI, HUNTER, BEISSBARTH	mitsubishi CANTER
H.C.B-A1084-B-36H	36	CEMB, BOSCH	MITSUBISHI CANTER
H.C.B-A1084-B-38H	38	FAIP, CORGHI	MITSUBISHI CANTER
H.C.B-A1084-B-40H	40	HOFFMAN, HUNTER, BEISSBARTH	MITSUBISHI CANTER
H.C.B-A1084-C	40	HOFFMAN, HUNTER, BEISSBARTH	JEEP
H.C.B-A1084-D	40	HOFFMAN, HUNTER, BEISSBARTH	MITSUBISHI CANTER

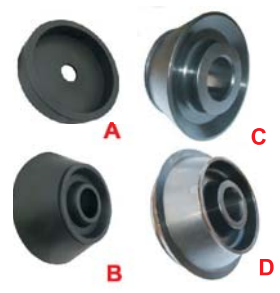

H.C.B-A1374 UNIVERSAL WHEEL BALANCE ADJUSTER

多功能校輪盤

- To align the wheel when changing new ones.
- Application:

∅	Brand of car
100	Toyota, Seat, Audi, Skoda
108	Volvo, Lancia Gamma, Citroen MX
112	Ford, Audi, Benz, BMW
114.3	Mitsubishi, Mazda, Toyota, Nissan, Honda
120	BMW, Opel
139.7	VW, Ford Transit, Benz
160	Ford Transit, Benz

No.	d1	d2
A1374-A	∅36	∅36
A1374-B	∅38	∅38
A1374-C	∅40	∅40



H.C.B-B1374 UNIVERSAL WHEEL BALANCE ADJUSTER

多功能校輪盤

- To align the wheel when changing new ones.
- Application:

∅	Brand of car
98	Alfa Romeo 164, Citroen CX, Lancia Thema 8.32
110	Opel, Saab
118	Ducato, Peugeot, Citroen
120.65	Jaguar, GMC, Maseati, Chevrolet
127	GMC, Rover, USA cars, Jaguar
130	Benz, Audi, Prosche
140	Benz



No.	d1	d2
B1374-A	∅36	∅36
B1374-B	∅38	∅38
B1374-C	∅40	∅40





H.C.B-C1374

UNIVERSAL WHEEL BALANCE ADJUSTER

多功能校輪盤

- To align the wheel when changing new ones.
- Application:

Ø	Brand of car
98	Fiat, Lancia, Alfa Romeo, autobianchi, Talbot, Lada, Skoda
100	BMW, Opel, Audi, Volvo, VW, Toyota, Honda, Nissan
108	Ford, Audi, Alfa Romeo, Citroen BX, Maserati
110	Mazda 323, Mazda 606
114.3	Mitsubishi, Daihatsu, Mazda, Saab, Toyota, Suzuki, Nissan, Ford USA, Honda, Hyundai
120	Honda, Mazda
130	VW, Ford Transit, Benz



No.	d1	d2
C1374-A	Ø36	Ø36
C1374-B	Ø38	Ø38
C1374-C	Ø40	Ø40

H.C.B-A1086

DUST SHIELD INSTALLER

防塵套張力擴張器

10 / 17.2 / 20 / 3.02'

- This tool is designed to extend the dust shield to install into the propeller shaft.



H.C.B-A1086-1

DUST SHIELD KIT

可擴性張力防塵套

30 / 7.5 / 10.1 / 1.75'

- Extendable dust shield can fit most kinds of propeller shaft.

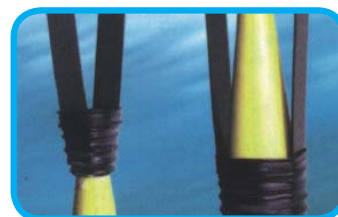



010

HWANG CHERNG BIN
Specialty Tools Inc.

一般修護工具 底盤
General Chassis Repair Tool

General Chassis

H.C.B-A1086-3 STEERING KNUCKLE DUST SHIELD KIT

方向機防塵套



H.C.B-A1086-4 STEERING KNUCKLE DUST SHIELD INSTALLER

方向機防塵套擴張器



H.C.B-A1095-4H EXPELLER BELL FOR HUB EXTRACTION (4 HOLES)

輪軸拔卸器 (4 孔)

4 / 15.48 / 17.2 / 1.6'



H.C.B-A1095-4H



H.C.B-A1095-5H



H.C.B-A1095-5H EXPELLER BELL FOR HUB EXTRACTION (5 HOLES)

輪軸拔卸器 (5 孔)

4 / 12.7 / 17 / 1.6'

- Expeller for hub extraction with mechanical spindle includes 4 or 5 conical washers.
- P.C.D. ranges from diameter 96 - 126 mm
- 4H: HONDA ACCORD, TOYOTA, MITSUBISHI, most Japanese vehicles.
- 5H: BENZ and BMW, most European vehicles.
- Material of main body: SCM 440
- Hardness: HRC 35° ~ 40°



H.C.B-A1503

TOYOTA HIACE AXLE EXTRACTOR PAT.M253503

TOYOTA HIACE 輪軸拔卸器

- This kit can quickly push the axle out of the hub, and remove the hub.
- P.C.D: \varnothing 130 ~ 160 mm
- Application:

\varnothing	Brand of car	Size
130	BENZ,AUDI,PROSCHE	5 HOLES
130	VW,FORD TRANSIT,BENZ	4 HOLES
139.7	VW,FORD TRANSIT,BENZ	4 HOLES
140	BENZ	5 HOLES
160	FORD TRANSIT,BENZ	4 HOLES



No.	Description	Specification	Q' TY	Remark
1	Extractor	D: \varnothing 185x111L	1	D: \varnothing 57x14UNC
2	Screw	D: \varnothing 57x14UNCx36L	1	D:M24xP1.5
3	Bolt	M24xP1.5x185L	1	H19
4	Mandrel	\varnothing 25x30L	1	
5	Washer	M12x t2	6	
6	Nut	D:M12xP1.5	6	H19

H.C.B-B1503

UNIVERSAL AXLE EXTRACTOR (SLIDE HAMMER) PAT.M253503

通用輪軸拔卸器 (滑錘式)

- This kit can quickly push the axle out of the hub, and remove the hub.
- P.C.D: \varnothing 130 ~ 160 mm.
- Application:

\varnothing	Brand of car	Size
130	BENZ,AUDI,PROSCHE	5 HOLES
130	VW,FORD TRANSIT,BENZ	4 HOLES
139.7	VW,FORD TRANSIT,BENZ	4 HOLES
140	BENZ	5 HOLES
160	FORD TRANSIT,BENZ	4 HOLES

- Specification:

No.	Description	Specification	Q' TY	Remark
1	Multi-hole Plate	D: \varnothing 185x111L	1	d: \varnothing 57x14UNC
2	Nut	D: \varnothing 57x14UNCx36L	1	d:M24xP1.5
3	Bolt	M24xP1.5x185L	1	H19
4	Mandrel	\varnothing 25x30L	1	
5	Washer	M12x t2	6	
6	Nut	d:M12xP1.5	6	H19
7	Hand bar	\varnothing 61x660L	1	D:5/8"x10UNC
8	Nut	D:5/8"x10UNC	1	H24
9	Slide hammer	90x168L	1	
10	Nut	D: \varnothing 57x14UNCx36L	1	d:5/8"x10UNC



H.C.B-C1503 UNIVERSAL AXLE EXTRACTOR (HYDRAULIC) PAT.M253503

通用輪軸拔卸器 (液壓式)

- This kit can quickly push the axle out of the hub, and remove the hub.
- P.C.D: Ø 130 ~ 160 mm
- Application:

Ø	Brand of car	Size
130	BENZ,AUDI,PROSCHE	5 HOLES
130	VW,FORD TRANSIT,BENZ	4 HOLES
139.7	VW,FORD TRANSIT,BENZ	4 HOLES
140	BENZ	5 HOLES
160	FORD TRANSIT,BENZ	4 HOLES

■ Specification:

No.	Description	Specification	Q' TY	Remark
1	Multi-hole Plate	D: Ø185x111L	1	d:Ø57x14UNC
2	Hydraulic	10tons	1	D:Ø57x14UNC
3	Mandrel	D: Ø38x59L	1	d:Ø 7/8"
4	Washer	M12x t2	6	
5	Nut	d:M12xP1.5	6	H19

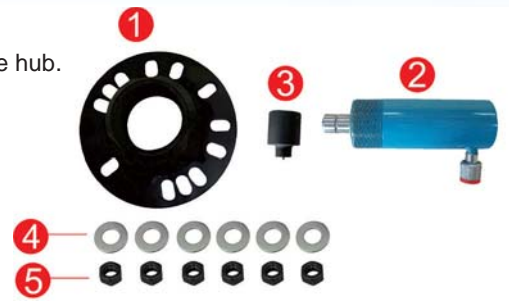

H.C.B-A1096 EXPELLER BELL FOR HUB EXTRACTION (HYDRAULIC) PAT. M 253503

油壓輪軸拆卸組

2 / 21.8 / 22.8 / 0.77'

- Expeller for hub extraction with mechanical spindle includes 5 conical washers.
- P.C.D. rage from Ø 96 – 126 mm
- 4H: HONDA ACCORD, TOYOTA, MITSUBISHI, most Japanese vehicles.
- 5H: BENZ and BMW, most European vehicles.
- Hydraulic Cylinder Pressure: 10 tons
- Material of main body: SCM 440
- Hardness: HRC 35° ~ 40°



H.C.B-A2037 HUB SLIDE HAMMER PULLER (5 HOLES)

前後軸通用倒盾組 (5 孔)

3 / 18.9 / 20.9 / 2.4'

- Pull flange-type rear axles on most latest model passenger cars & light truck.
- Designed to fit axles with bolts & studs up to 5/8" TW10 DIA.



H.C.B-B2037 HUB SLIDE HAMMER PULLER (5 HOLES)

前後軸通用倒盾組 (5 孔)

4 / 27.5 / 29.8 / 2.21'





H.C.B-C2037

PROPELLER SHAFT HAMMER PULLER (ROPE)

前後軸通用倒盾組 (鋼索式)



H.C.B-A2040

HUB SLIDE HAMMER PULLER (4 HOLES)

前後軸通用倒盾組 (4孔)

- Pulls 4 bolts front hub easily with the 10 LB slide hammer.
- Heavy duty tool for rugged jobs.



H.C.B-B2040

HUB SLIDE HAMMER PULLER (4 HOLES)

前後軸通用倒盾組 (4孔)



H.C.B-A2041

FRONT WHEEL DRIVE AXLES PULLER

傳動軸倒盾組 (方形盤)

- Simply secure shaft through opening in adapter to remove the half shaft from CV joints on most FWD vehicles.



H.C.B-B2041

FRONT WHEEL DRIVE AXLES PULLER

傳動軸倒盾組 (方形盤)



H.C.B-A1116-36H

ALUMINUM RETAINING RING ADJUSTMENT TOOL (CEMB)

鋁圈校正器 - 36H



H.C.B-A1116-38H ALUMINUM RETAINING RING ADJUSTMENT TOOL (FAIP, CORGHI)

鋁圈校正器 -38H

■ Set of wheel back centering bushing

- B1: Bushing Ø 56.5-57 (1)
- B2: Bushing Ø 65.67 (2)
- B3: Bushing Ø 73.2-75,4 (3)
- B4: Bushing Ø 63.3-64 (4)
- B5: Bushing Ø 58-60 (5)
- B7: Bushing Ø 56-54 (7)

- (1) AUDI, BMW, CHRYSLER, OPEL, SEAT, VW.
- (2) AUDI, CITROEN, HYUNDAI, LANCIA, MASERATI, MAZDA. MERCEDES, MITSUBISHI, NISSAN, OPEL, PEUGEOT, SAAB, VOLVO.
- (3) BMW, PORSCHE.
- (4) FORD, HONDA, ROVER.
- (5) ALFA ROMEO, CITROEN, FIAT, LADA, MASERATI, MAZDA, PEUGEOT, RENAULT, SEAT, SKODA, TOYOTA.
- (6) CITROEN, DAIHATSU, HONDA, KIA, MAZDA, MITSUBISHI, PEUGEOT, ROVER, SUBARU, TOYOTA.



H.C.B-A1116-40H ALUMINUM RETAINING RING ADJUSTMENT TOOL (HOFFMAN, HUNTER)

鋁圈校正器 -40H



H.C.B-A1163 MITSUBISHI GALANT REAR AXLES BUSH REMOVER/INSTALLER PAT. PEN

三菱 GALANT 後羊角鐵套拆裝工具組

10 / 13.3 / 14.3 / 1.55"

- Removal and replacement tool for metallic bushes on rear axles for MITSUBISHI GALANT.
- This tool incorporates an axial bearing and also incorporates a pressure piece which guarantees the correct position of the new metallic bushes when replaced.
- Application: MITSUBISHI GALANT.





H.C.B-A1354

ON CAR

TOYOTA (4WD/PRERUNNER) FRONT LOWER SUSPENSION ARM BUSH EXTRACTOR / INSTALLER

TOYOTA (4WD / PRERUNNER) 前三角架控制臂鐵套拆裝組



■ Application: Land Cruiser Prado

No.	Description	Qty
1	φ 71 x L130	1
2	φ 63 x L130	1
3	φ 84 x L32	1
4	φ 74 x L32	1
5	φ 72 x L26	1
6	φ 71 x L27	1
7	φ 63 x L26	1
8	φ 62.5 x L24	1
9	M14 x P2.0 x L344	1
10	M14 x P2.0 x L180	1
11	M14 x P2.0 bowl nut	1
12	Bearing 51103	1



Extraction step 1: Remove Big Bush

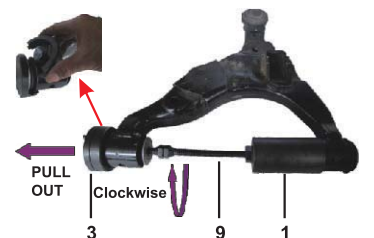

Fix A1354-3 on front of the big bush, and add A1354-1 & A1354-9 on the other side. Turn the tools clockwise and pull the big bush out.

H.C.B-B1354

TOYOTA (4WD/PRERUNNER) FRONT LOWER SUSPENSION ARM BUSH EXTRACTOR / INSTALLER

TOYOTA (4WD / PRERUNNER) 前三角架控制臂鐵套拆裝組



■ Remove the nuts and washers of bushes in two sides.
■ Application: TOYOTA HIACE. VIGO of bushes in two sides.

No.	Description	Qty
1	L138 TY22 x P3.0	1
2	φ 79.5 x L100	1
2-1	Hexagon screw M12 x P1.25 x L50	2
3	φ 67 x L40	1
4	φ 68.5 x L20	1
5	φ 58.5 x L43	1
6	φ 54 x L15	1
7	φ 44 x L15	1
8	φ 69 x L12	1
9	M14 x P2.0 bowl nut	1
10	M20 x P1.5 x L267	1
11	M14 x P2.0 x L240	1
12	Bearing 2904	1
13	Bearing 51103	1

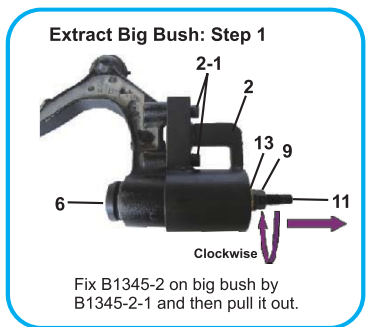

Fix B1345-2 on big bush by B1345-2-1 and then pull it out.

H.C.B-A1173 PEUGEOT (406) BUSH EXTRACTION/ INSTALLATION TOOL KIT

標緻 (406) 三角架鐵套拆裝器

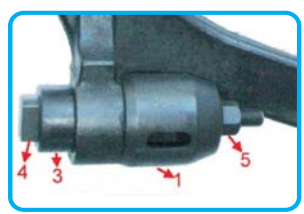
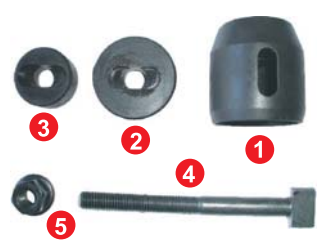

EXTRACTOR



INSTALLER

H.C.B-A1177 TOYOTA ZACE/DAF BALL JOINT EXTRACTOR (32 mm)

TOYOTA 瑞獅 /DAF 方向機主機球頭拔卸器 (32 mm)

- For the removal of the track rod end from the drag link.
- On car maintenance.
- Best tool for removal light truck ball joint.
- Easy to use and can save time and money.
- Application:
TOYOTA ZACE commercial and DAF wagon.

Technical information

- Make sure the propeller shaft dimension or specification is correct while installing.
- Pay attention to propeller shaft removal and installation. No impact, crack, and damage are allowed.
- The ball-joint may suddenly break up from the tie-rod end, so the nut and bolt must have at least 4 to 5 teeth installed, otherwise it may cause casualties.
- Use a hammer to hit the punch nut on the tool in order to separate the ball-joint.

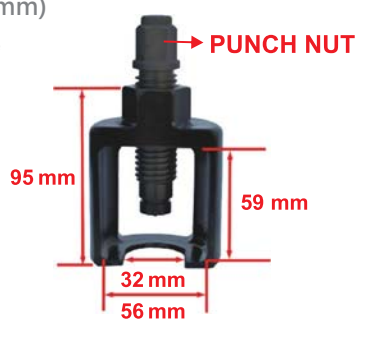

H.C.B-A1191 UNIVERSAL BALL JOINT SEPERATOR (22 mm)

萬用球接頭拆裝工具組 (22 mm)(橫拉桿)

- For splitting track-rod ends, anti-roll bar ball joints.....etc., especially in small space.



H.C.B-A1194 UNIVERSAL BALL JOINT SEPERATOR (20 mm)

立式橫拉桿球頭拔卸器 (20 mm)

- It is good to use with powerful structure.
- Stand design to solve the space problem.
- Jaw open: 20 mm.





H.C.B-A1192

JEEP WRANGLER FRONT SUB-FRAME BALL JOINT EXTRACTOR / INSTALLER

藍哥前三角架球接頭拆裝工具組

■ Application: Jeep Wrangler.



Tool Kit



Wrangler Ball Joint

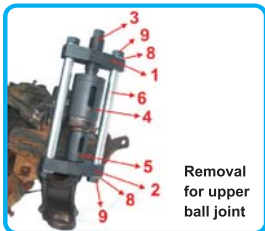

Removal for upper ball joint

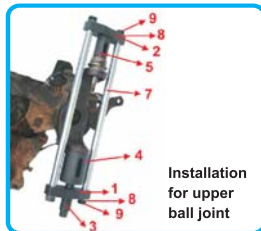

Installation for upper ball joint

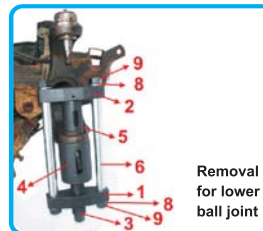

Removal for lower ball joint

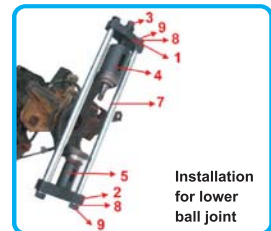

Installation for lower ball joint

H.C.B-B1192

JEEP WRANGLER FRONT SUB-FRAME BALL JOINT EXTRACTOR/INSTALLER (ACCESSORY)

藍哥前三角架球接頭拆裝工具組 (配件)



H.C.B-A1254

PEUGEOT BALL JOINT SOCKET (Dr. 1/2", 4 TEETH, 52 mm)

標緻球接頭拆裝套筒 (Dr. 1/2", 4 齒, 52 mm)



Dr. 1/2"

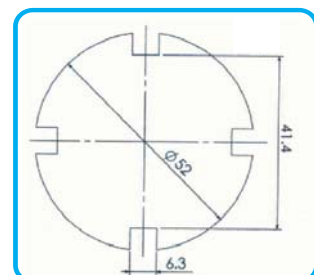

H.C.B-A2308

NEW

HYDRAULIC BALL JOINT SEPARATOR (8 TONS)

油壓球接頭拆卸器 (8 噸)

- Hydraulic ball joint separator: 8 tons
- Jaw opening 56 mm, Jaw width 22 mm, Jaw depth 30 mm
- Fork body Material: SCM 440
- Spindles maximum torque pressure 40 Nm.
- This extra heavy duty ball joint separator is designed to split the most stubborn joint taper with ease.



H.C.B-B2122

BALL JOINT SEPARATOR (19 mm)

橫拉桿球接頭拆卸器 (19 mm)

- High grade (Cr-Mo) alloy steel for maximum strength.
- Fit many domestic and imported front wheel drive vehicles.
- Removable pin fits into two pivot points for versatility.
- Accept a 3/4" socket or wrench.
- Jaw open: 19 mm.
- With safety rope to avoid drop while operating.



H.C.B-C2122

BALL JOINT SEPARATOR (NARROW TYPE)

橫拉桿球接頭拆卸器 (窄版)

- High grade (Cr-Mo) alloy steel for maximum strength.
- Fits many domestic and imported front wheel drive vehicles.
- Removable pin fits into two pivot points for versatility.
- Accepts a 7/8" socket or wrench.
- The mini operation space: 6-7 mm.
- Jaw open: 19 mm.
- Have safety rope to avoid drop while operating.



H.C.B-A2044

AIR PRESSURE DISK BRAKE CALIPER RETURN TOOL

氣壓式後輪碟式分泵回復器

- Application:
TOYOTA, VW, HONDA....., etc.

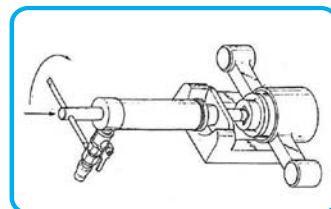

H.C.B-A2052

METAL T HANDLE RASP EYE TOOL

補胎鑽

- Durable metal T handle.
- Changeable tip design.





010
HWANG CHERNG BIN
 Specialty Tools Inc.

General Chassis



H.C.B-A2053

METAL T HANDLE CLOSED EYE TOOL

補胎針

- Durable metal T handle.
- Changeable tip design.



H.C.B-A2055

SPRING COMPRESSOR (STAND)

立式彈簧壓縮器

- Two different U type hooks suit for most cars.
- Grease the screw before using.



H.C.B-A2071

PEUGEOT/ CITROEN PENTAGON BRAKE SOCKET (19 mm)

標緻 / 雪鐵龍 5 角煞車套筒 (19 mm)

- Application:
For using on bendix brakes on PEUGEOT and CITROEN vehicles.



H.C.B-A2072

PENTAGON SOCKET BIT FOR GIRLING BRAKES (Dr. 1/2", 10 mm)

5 角煞車套筒 (Dr. 1/2", 10 mm)

- For most of vehicles fitting with girling brake systems.
- Chrome vanadium bit holder, correctly hardened, tempered and chrome plated.
- Size: Dr. 1/2", 10 mm



Dr. 1/2", 10 mm

H.C.B-A2079

MULTI-PURPOSE INNER TIE ROD TOOL (33-42 mm)

方向機舵桿扳手 (通用型) (33-42 mm)

50 / 27.2 / 28.5 / 0.86'

- The master tie rod tool easily replaces inner tie rod ends without removing the rack and pinion.
- Capacity: 33-42 mm





010
HWANG CHERNG BIN
Specialty Tools Inc.

一般修護工具 底盤
General Chassis Repair Tool

General Chassis

H.C.B-B2079

MULTI-PURPOSE INNER TIE ROD TOOL (36-42 mm)

方向機舵桿扳手 (36-42 mm)

50 / 18.7 / 19.4 / 0.74'

- This master tie rod tool easily replaces inner tie rod ends without removing the rack and pinion.
- Capacity: 36-42 mm



H.C.B-C2079

TRACK ROD END REMOVER/INSTALLER (35~45 mm)

方向機舵桿扳手 (35 mm~45 mm)

H.C.B-D2079

TRACK ROD END REMOVER / INSTALLER (45 mm~50 mm)

方向機舵桿扳手 (45 mm~50 mm)

10 / 15 / 16 / 1.8'

Item no.	C2079	D2079
Head application	Ø 35-45 mm	Ø 45-50 mm
Head OD	Ø 89 mm	Ø 89 mm
Length	400 mm	400 mm



- Hex part on the end of tool: work with 27 mm hex wrench or Dr.1/2" wrench.
- Function: Remove and replace the axial joint.



REMOVAL & INSTALLATION

Step 1.

The hollow body allows the track rod to be passed in until the axial joint touches the head part of this tool.

Step 2.

Use a 27mm spanner or Dr.1/2" socket to work the end of this tool, turn it anticlockwise to loosen the axial joint.

Step 3.

Replace a new axial joint and track rod by the same manner as in step2, and turn the tool, clockwise for fastening.





H.C.B-A2088

SUZUKI AXLE NUT SOCKET (8 TEETH)

金吉星傳動軸專用套筒 (8 齒)

- Special design on 8 teeth for suiting the transmission nut.
- Launched after 2000.
- Application: ISUZU modle with 4WD.



H.C.B-A2099

FRONT WHEEL DRIVE AXLE PULLER

傳動軸滑鏈組 (鋼索式)

- Use the extension and adjustable wire to clip the axle tightly.
- Pull out with the slide hammer easily.

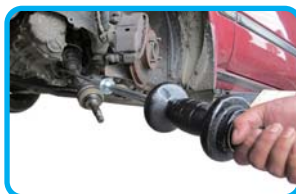

H.C.B-C2095

NEW

PNEUMATIC HYDRAULIC MACPHERSON SPRING DUMPER COMPRESSOR DE.PAT. TW PAT. M518188 CE

氣動多功能油壓彈簧避震器拆裝器

■ Specification:

Height	Length	Width	Upper Base Travel	Lower Base Travel	Weight
1320 mm	690 mm	520 mm	226 mm	240 mm	112 Kg

■ Function:

This compressor is suitable for the disassembly and maintenance of all kinds of shock absorbers. Moreover, it's very suitable for the stiffer shock absorber of SUV as well. Such as: BMW X5, X6, Mercedes-Benz ML, GL, Audi Q5, Q7, Porsche Cayenne, Lexus RX, Infinity FX.....etc.

■ Features:

1. Driven by air pump to save labor and time.
2. Whole new adjustable upper fixing jaw provides stronger holding ability.
3. Safety guard can prevent from danger when operating.
4. Whole new lower supporting base which can support the bottom of the shock absorber.
5. Whole new adjustable stands can fit the ground perfectly to provide the maximum stability.
6. There are wheels and bars behind this compressor which make it more convenient when moving it.
7. The lower fixing base is changeable. It can be changed into lower fixing jaw or lower fixing bracket.

■ Caution:

Please always keep the safety guard closed to avoid any danger when operating.

CE



No.	Description	Range
1	Fixing Jaw	30 ~ 70 mm
2	Fixing Bracket (Small)	Ø 75 ~ 110
3	Fixing Bracket (Medium)	Ø 110 ~ 140
4	Fixing Bracket (Large)	Ø 140 ~ 190



010
HWANG CHENGBIN
Specialty Tools Inc.

一般修護工具 底盤
General Chassis Repair Tool

H.C.B-B2095

NEW

HYDRAULIC MACPHERSON SPRING DUMPER COMPRESSOR DE.PAT. TW PAT.M518188 CE

多功能油壓彈簧避震器拆裝器



No.	Description	Range
1	Fixing Jaw	30 ~ 70 mm
2	Fixing Bracket (Small)	ψ 75 ~ 110
3	Fixing Bracket (Medium)	ψ 110 ~ 140
4	Fixing Bracket (Large)	ψ 140 ~ 190



The lower fixing base is changeable. It can be changed into lower fixing jaw or lower fixing bracket.

CE

Whole new adjustable upper fixing jaw provides stronger holding ability.



Please always keep the safety guard closed to avoid any danger when operating.

Safety guard can prevent from danger when operating.



There are wheels and bars behind this compressor which make it more convenient when moving it.

Whole new lower supporting base which can support the bottom of the shock absorber.

Adjustable stands can fit the ground perfectly to provide the maximum stability.

Specification:

Height	Length	Width	Upper Base Travel	Lower Base Travel	Weight
1320 mm	690 mm	520 mm	226 mm	240 mm	112 Kg

Function:

This compressor is suitable for the disassembly and maintenance of all kinds of shock absorbers. Moreover, it's very suitable for the stiffer shock absorber of SUV as well. Such as: BMW X5, X6, Mercedes-Benz ML, GL, Audi Q5, Q7, Porsche Cayenne, Lexus RX, Infinity FX.....etc.

H.C.B-A2095

HYDRAULIC MACPHERSON SPRING DUMPER COMPRESSOR

多功能油壓彈簧避震器拆裝器

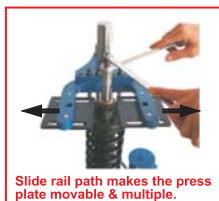

Slide rail path makes the press plate movable & multiple.

The metal press plate can be used on the springs which are in high density (smaller clearance).



Strong press arms design.

Hooks can be turned 360° and easily take apart shaking-avoid spring.

SAFE QUICK STEADY



Multiple function design Apply to all kinds of shaking-avoid spring

Hydraulic design makes the operation Quick, Safe, & Steady.



With design of adjustable clamp, which can clamp and size of shaking-avoid spring stably to avoid danger when operation.

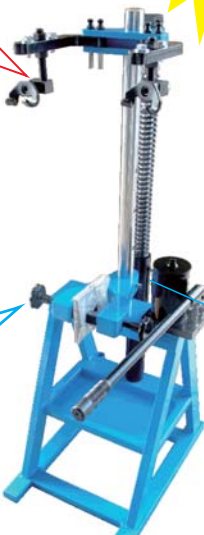

This adjustable mechanical design makes this tool applicable to all lengths of the shock absorbers.

Specification:

Height	Length	Width	N.W./G.W.	Lead of Press
1255 mm	570 mm	405 mm	57.5 / 73KGS	390 mm



H.C.B-C2184

6 PCS IMPACT SOCKET KIT (Dr. 1/2", MS17&15/17/19/21/22 mm)

6 PCS 輪胎套筒組 (Dr. 1/2", MS17&15/17/19/21/22 mm)

- Material: 15 mm & MS17: CR-V17-19-21-22 mm: CR-MO
- Overall Length: 87 mm
- Hexagon socket: 15-17-19-21-22 mm
- Wheel Lug Socket MS17
- MS17 is specially designed to loosen and tighten the new special wheel bolts found on Mercedes vehicles (17 mm waf).
- Suitable for Mercedes vehicles, such as C-Class / GLK (W204), E-Class (W211, W212, W207), SLK (W172), M-Class (W164, W166), CL-Class (W216), S-Class (W221, W222) and Maybach



H.C.B-A2184

3 PCS THIN WALL DEEP IMPACT SOCKET KIT (Dr. 1/2")
(17 mm/19 mm/21 mm)

3 PCS 輪胎套筒組 (Dr. 1/2") (17 mm/19 mm/21 mm)

- The most popular colorful socket are treated by chromate.
- Plastic sleeves protect the aluminum wheels from damaged.
- Heat treatment chamfered ends make the sockets to attach to the nuts easily.
- Non-slip design enforces the adhesion between the nuts and socket.
- Character: Plastic sleeves protect wheels, Durable Cr-Mo Steel avoid slip, high torque design
- Size: 17 mm with blue plastic sleeve
19 mm with yellow plastic sleeve
21 mm with red plastic sleeve



H.C.B-B2184

ALLOY WHEEL DEEP IMPACT SOCKET KIT 150 mm (L) (Dr. 1/2", 5 PCS)

氣動輪胎套筒組 150 mm 長 (Dr. 1/2", 5 PCS)

- Anodized Chrome Molybdenum Dr. 1/2" drive sockets.
- Suitable for using with impact tools.
- Feature nylon sleeve and insert to prevent damage to alloy wheels.
- Colour coded sockets for easy size selection.
- Comprise with deep 17, 19 and 21 mm Dr. 1/2" drive sockets, plus spare nylon sleeves



H.C.B-A2183

HYDRAULIC STEERING SYSTEM PRESS TOOL KIT (47 PCS)

萬用型鐵套拆裝組 (油壓式) (47 PCS)

1 / 32.6 / 33.6 / 2.9'

- Hydraulic cylinder provides a quick repair work.
- Press hydraulic pump then turn short accessory into long accessory to disassemble bush, exchange the position of short and long accessories when replacing bush.
- For universal cars
- Max pressure load: 16 tons

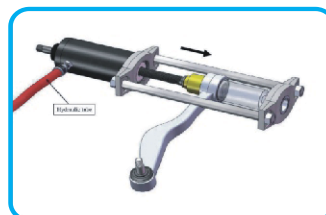

H.C.B-B2183 HYDRAULIC BUSH EXTRACTOR (EXTRA LARGER PARTS)

油壓式鐵套拆裝器 (加大配件)

- Allow the combination with hydraulic cylinder of A2183, C2183, D2183.
- 10 parts from ($\phi 62 \sim \phi 80$, in 2 mm increment), 2 pcs per part.

Description	Q'ty	Specification
Long Bush	10	OD x ID(mm) x 110(mm/L) 70x60, 72x64, 74x66, 76x68, 78x70, 80x72, 82x74, 84x76, 86x78, 88x80
Short Bush	10	OD x ID(mm) x 40(mm/L) 70x60, 72x64, 74x66, 76x68, 78x70, 80x72, 82x74, 84x76, 86x78, 88x80



H.C.B-C2183 STEERING SYSTEM PRESS TOOL (57 PCS)

手動式汽車拉桿避震鐵套更換工具 (57 PCS)

1 / 30.6 / 31.6 / 2.9'

Item No.	Description	Q'ty	Specification
C2183-1	Hydraulic Cylinder	1	10 tons
C2183-2	Connect Bush	1	
C2183-3	Pointed Short Bush	1	28mm
C2183-4	Pointed Long Bush	1	95mm
C2183-5	Short Bush	22	OD x ID(mm) x 40(mm/L) 26x18, 28x20, 30x22, 32x24, 34x26, 36x28, 38x30, 40x32, 42x34, 44x36, 46x38, 48x40, 50x42, 52x44, 54x46, 56x48, 58x50, 60x52, 62x54, 64x56, 66x58, 68x60
C2183-6	Long Bush	22	OD x ID(mm) x 100(mm/L) 26x18, 28x20, 30x22, 32x24, 34x26, 36x28, 38x30, 40x32, 42x34, 44x36, 46x38, 48x40, 50x42, 52x44, 54x46, 56x48, 58x50, 60x52, 62x54, 64x56, 66x58, 68x60
C2183-7	Fixing Nut	1	
C2183-8	Fixing Nut	1	
C2183-9	Pull Spindle	4	M10*1.5P, M12*1.75P, M14*2.0P, M16*2.0P
C2183-10	Fixing Spindle	4	M10*1.5P, M12*1.75P, M14*2.0P, M16*2.0P

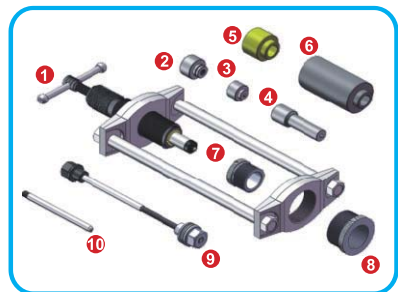

H.C.B-D2183 HYDRAULIC STEERING SYSTEM PULL TOOL KIT (49 PCS)

油壓式汽車拉桿避震鐵套更換工具 (49 PCS)

1 / 30.6 / 31.6 / 2.9'

Item No.	Description	Q'ty	Specification
D2183-1	Hydraulic Cylinder	1	18.2 tons
D2183-2	Pull Spindle	4	$\phi 10, \phi 12, \phi 14, \phi 16$ (mm)
D2183-3	Adjustable Nut	1	
D2183-4	Long Bush	22	OD x ID(mm) x 100(mm/L) 26x18, 28x20, 30x22, 32x24, 34x26, 36x28, 38x30, 40x32, 42x34, 44x36, 46x38, 48x40, 50x42, 52x44, 54x46, 56x48, 58x50, 60x52, 62x54, 64x56, 66x58, 68x60
D2183-5	Short Bush	22	OD x ID(mm) x 40(mm/L) 26x18, 28x20, 30x22, 32x24, 34x26, 36x28, 38x30, 40x32, 42x34, 44x36, 46x38, 48x40, 50x42, 52x44, 54x46, 56x48, 58x50, 60x52, 62x54, 64x56, 66x58, 68x60
D2183-6	3/8" Adaptor	1	

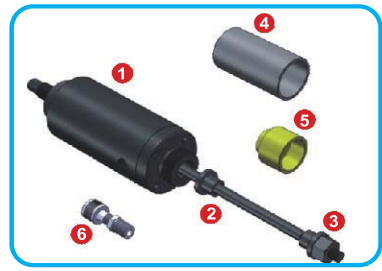



H.C.B-E2183

UNIVERSAL SLEEVE REMOVAL / INSTALLATION TOOL KIT (26 PCS)

中空油壓式汽車拉桿避震鐵套更換組 (全車系)

- Universal purpose bases fit many kinds of different vehicles.
- Easy work to remove and install:
 - Bearing bush
 - Silent bearing
 - Hydraulic bearing
 - Rubber bearing
- Force Screw - L: 450 mm (4 pieces) (with 27 mm HEX nut): M10 x P1.5/M12 x P2.0/M14 x P2.0/M16 x P2.5.
- External Sleeve Diameter.
- Sleeve 'A' (11 pcs) Gold: D44 x d34/D46 x d36/D54 x d44/D56 x d46/D58 x d48/D66 x d56/D68 x d58/D70 x d60/D78 x d68/D80 x d70/D82 x d72.
- Sleeve 'B' (9 pieces) Silver: D48 x d38/D50 x d40/D52 x d42/D60 x d50/D62 x d52/D64 x d54/D72 x d62/D74 x d64/D76 x d66.



H.C.B-A1416

SUZUKI JIMNY FRONT WHEEL AXLE NUT SOCKET (Dr. 1/2")

SUZUKI JIMNY 仰角前輪軸螺帽套筒 (Dr. 1/2")

- To install and remove nut of SUZUKI JIMNY front wheel axle when bearing is broken.
- Due to the special design nut of SUZUKI JIMNY, it is hard to install or remove the nut without this tool.
- Material: SCM440
- It can be used with torque wrench.
- Application: SUZUKI JIMNY front wheel axle.



H.C.B-A1445

UNIVERSAL SUSPENSION ARM LEVER PAT.M450505

撬棒

- For removing ball joints, control arms and other suspension components.
- Six adjustment points to get maximum fit and leverage.
- The suspension arm lever is not intended to break the taper of the suspension joint. The joint must be separated from the suspension arm using the appropriate tool and then the lever can be used to facilitate the removal.
- Refer to figure, the fulcrum point (end of suspension arm lever) should be adjacent to the pivot point of the suspension arm.

Overall length: 100 cm (60 cm + 40 cm)
Inner diameter: 24 cm
Outer diameter: 30 cm





010
HWANG CHERNG BIN
Specialty Tools Inc.

一般修護工具 底盤
General Chassis Repair Tool

General Chassis

H.C.B-C1445 **NEW** UNIVERSAL SUSPENSION ARM LEVER (MULTIPLE) PAT.M450505

撬棒 (多角度)

- For removing ball joints, control arms and other suspension components.
- Eight adjustment points to get the maximum fitness and leverage.
- The suspension arm lever is not intended to break the taper of the suspension joint, the joint must be separated from the suspension arm by using the appropriate tool and then this lever can be used to facilitate removal.
- Refer to figure, the fulcrum point (end of suspension arm lever) should be adjacent to the pivot point of the suspension arm.



H.C.B-A1457 TOYOTA HIACE FRONT WHEEL BEARING NUT SOCKET

TOYOTA HIACE 前輪軸承螺帽套筒

- This tool can remove front wheel bearing nut.
- Four pins design
- Application: TOYOTA HIACE car (After 2006).



H.C.B-A2231 WHEEL HUB NUT SOCKET KIT (Dr. 3/4") (8 PCS)

輪軸螺帽套筒組 (Dr. 3/4") (8 PCS)

- Suit front wheel hub fasteners on later model vehicles requiring longer sockets for hand to reach the hub nut.
- Bi-Hex Deep
Impact sockets are 120 mm long with 91 mm clearance.

- Double-Hexagon Impact Socket: 24 mm, 27 mm, 30 mm, 32 mm, 36 mm.
- Hexagon Impact Bit Socket: 14 mm, 17 mm, 19 mm.





H.C.B-A2234

FORD MONDEO REAR SUB-FRAME BUSH REMOVAL/ INSTALLATION TOOL KIT

FORD MONDEO 後三角架鐵套拆裝工具組

- For removing and installing the bushes on the rear sub-frame.
- Application: FORD MONDEO

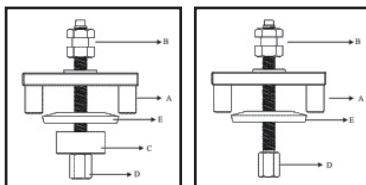

To remove old bushes (Part# No ABCDE) To remove new bushes (Part# No ABDE)



H.C.B-A1467

MITSUBISHI (VIRAGE/ LANCER) REAR TRAILING ARM BUSH REMOVER/ INSTALLER

MITSUBISHI (VIRAGE/ 菱帥) 後游臂鐵套拆裝工具組

- On car maintenance.
- Best tool for the replacement of bushes on MITSUBISHI VIRAGE 1.8 and MITSUBISHI LANCER 1.6.
- Won't damage ABS sensor cable, trailing arm and parts close to bush during maintenance.
- Quick and easy to use which can save time. Within just two minutes, the removal is completed.
- The window indicator is for reference during removal and installation.
- Application: MITSUBISHI LANCER 1.6 (1993 year-2000 year), MITSUBISHI VIRAGE 1.8 (After 2000).



H.C.B-F1168

ON CAR UNIVERSAL BALL JOINT SERVICE KIT PAT M.333280

專利型萬象十字接頭拆卸器

- Specially designed bolt. If the bolt is broken, you only need to replace the bolt of c-clamp, don't have to change the whole c-clamp set.
- The C-clamp is forged, its material is SCM440 and hardness is HRC 38° - 42°
- It contains heavy-duty C frame press, receiver tubes, and adaptors for installing and removing pins.
- This tool set is designed for using on most cars and light trucks that have press-fit type ball joints. It will help the user remove and install ball joints without the need of removing the control arm from the vehicle.

NOTE: Some cars and light trucks may have the upper ball joint spot-welded to the control arm. The weld must be cut before attempting to remove the ball joint.

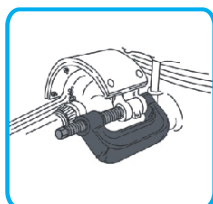

Brake Anchor pin
Extraction and installation

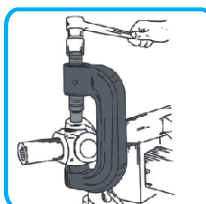

"U" joint Extraction
and installation

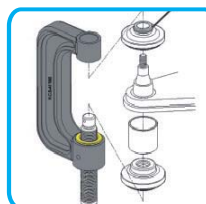

Removal

Patented design O-ring can be fixed in top ,tipprevent the tool from falling.

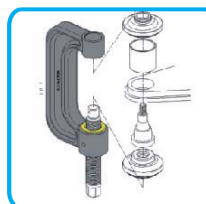

Installation

Patented design O-ring can be fixed in top ,tipprevent the tool from falling.

H.C.B-A2262 **UNIVERSAL STEERING KUNCKLE SPREADER**

綜合型仰角撐開工具組

- This tool is used to spread the steering knuckle to enable the removal and refitting of shock absorbers without the risk of damaging the aluminum or cast iron knuckle.
- This tool is adjustable and is therefore suitable for steering knuckles with either a centralized slot or a non centralized slot.
- Suitable for a wide range of vehicles including AUDI | BMW | CITROEN | VOLKSWAGEN (GOLF | PASSAT) | FORD | SKODA | SEAT | RENAULT | PEUGEOT and many Japanese vehicles.



H.C.B-A2264 **CLIC & CLIC-R HOSE CLAMP PLIERS**

防塵套裝束鉗

- Non-slip soft grip for added comfort and control.
- For the removal of Clic & Clic-R type hose clips fitted to most engines.



H.C.B-A1573 **ON CAR TOYOTA CAMRY REAR AXLES BUSH REMOVAL/ INSTALLATION TOOL KIT**

TOYOTA CAMRY 後仰角鐵套拆裝工具組

- Designed for replacing the three bushes of TOYOTA CAMRY rear axles.



Fig. 1
Remove the under bush.

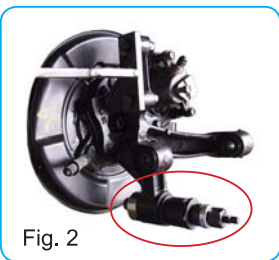

Fig. 2
Install the under bush.



TOYOTA CAMRY REAR AXLES BUSH

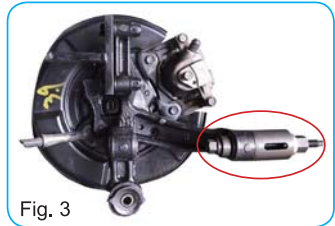

Fig. 3
Remove the right bush.

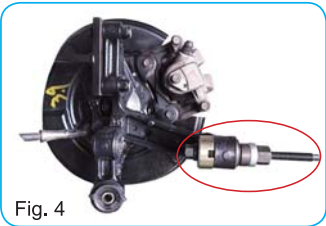

Fig. 4
Install the right bush.

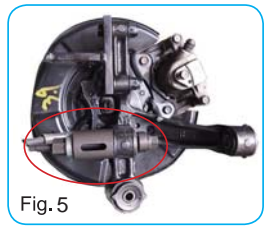

Fig. 5
Remove the left bush.

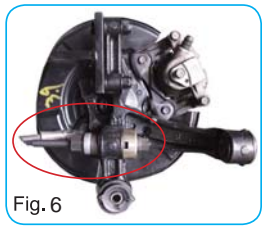

Fig. 6
Install the left bush.



H.C.B-A2277

TWIST AXLE SPINDLE RETHREADING KIT (9 PCS)

傳動軸 (輪軸) 螺牙修復器 (9 PCS)

- This tool set accesses axle threads on spindles of eight popular die sizes for both cleaning and rethreading work.
- Special twist shape provides an easier & quicker work.
- Application: When the axle screw is damaged or rusty.
- Die Sizes:
M20 x 1.25 ; M20 x 1.50
M22 x 1.00 ; M22 x 1.50
M24 x 1.50 ; M24 x 2.00
13/16" x 20 UNEF; 3/4" x 20 UNEF
Extension bar (OD: 27 mm)
- Technical Data:
Die Material: SCM440 ; Hardness: HRC 45 ~ 48 degree
Extension bar: Material-S45C ; Hardness: HRC 38 ~ 43 degree



H.C.B-A2293

INNER BEARING RACE EXTRACTOR KIT

軸承內圈環拔卸器

- Allow precise extraction of inner bearing race from the wheel hub.
- Removal of the hub always leaves the inner race on the hub. The race is impossible to remove without the correct special tool.
- Makeshift methods such as grinders, Chisels, Welding torches, etc. Represent severe risks of personal injury or damage to the components.
- The new puller set allow quick and easy removal of inner bearing races with diameters from 40 mm to 72 mm with a few minutes without risk of damage or injury.
- Application:
VW, Audi, BMW, Ford, Fiat, Mercedes-Benz, Opel, Renault, Peugeot, Volvo.....etc.



Part No.	Description	Part No.	Description
A1	Chuck	A5	Special Ring Spanner 36 mm
A2	Chuck	A6	Special with Pin (M20 x 1.5)
A3	Chuck	A7	Pressure Piece for Hubs
A4	Handle	A8	Pressure Piece for Hubs

Part No.	Description	Car classification
01	Chuck size φ 44-48 mm	Lancia Cappa, Remault
02	Chuck size φ 48-52 mm	Ford Transit, T330
03	Chuck size φ 52-56 mm	VW Audi, Seat, Skoda
04	Chuck size φ 56-60 mm	Mercedes W168
05	Chuck size φ 60-64 mm	Mercedes W201, W202, W203, W210, W214, BMW, Peugeot.
06	Chuck size φ 64-68 mm	Mercedes W163, W140, W169, W211, W220, W245, W124T
07	Chuck size φ 68-72 mm	VW Touareg, Porsche Cayenne

H.C.B-A1554 HYDRAULIC CYLINDER HOIST STAND (50 mm)

油壓缸支撐架 (50 mm)

H.C.B-B1554 HYDRAULIC CYLINDER HOIST STAND (73 mm)

油壓缸支撐架 (73 mm)

- This tool can be combined with jack, it can let operator use hydraulic easily and saving labor. It can be used with H.C.B-B1389 or H.C.B-D1129.
- Fix hydraulic on the support frame, and use with jack, you can adjust 360 degree. You don't need to handle with hand. Let the worker repair easily.



- This tool can be combined with jack, it can let operator use hydraulic easily and saving labor. It can be used with H.C.B-A1536 or H.C.B-D1181.
- Fix hydraulic on the support frame, and use with jack, you can adjust 360 degree. You don't need to handle with hand. Let the worker repair easily.





H.C.B-A1612

NEW

**MITSUBISHI SAVRIN REAR TRAILING ARM BUSHING
REMOVAL/ INSTALLATION TOOL KIT**

三菱 SAVRIN 後三角架鐵套拆裝工具組

- The rear trailing arm bush will be broken under continual wearing. It would increase the instability when driving and make driver feel uncomfortable. To maintain stability of the vehicle and cut down the risk. So replacement of the rear trailing arm bush is needed.
- Application: SAVRIN 2001-2009

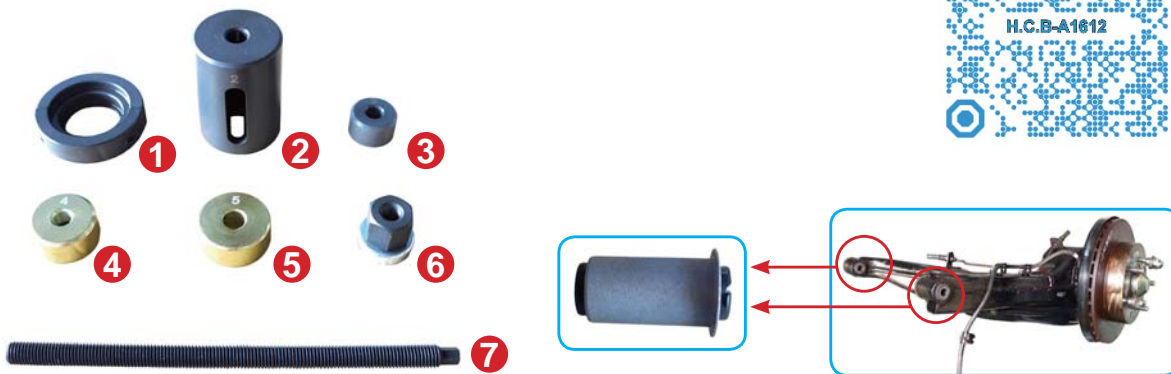
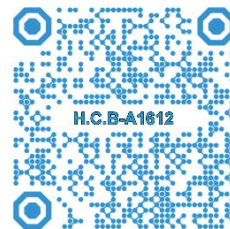

A、Rear Trailing Arm Front Bush

a、Removal:

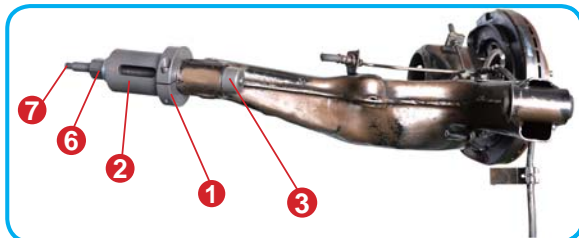

b、Installation:

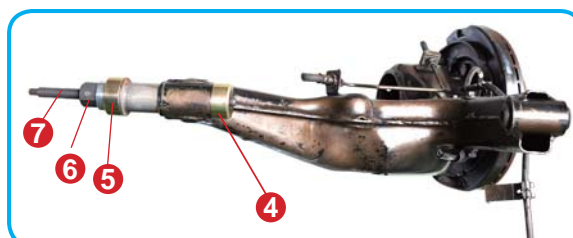

H.C.B-A1665

NEW

UNIVERSAL HYDRAULIC PRESSURE KIT

通用油壓組

- With easy spring reset.
- Hydraulic cylinder with thread and protective cap (3/8 NPT thread)
- Operating pressure: 700 bar
- Stroke length: 45 mm
- Outer diameter: 80 mm
- Hydraulic cylinder: 17.5 tons



H.C.B-A1623 **NEW** **TOYOTA REAR AXLE SUSPENSION BUSH REMOVAL/ INSTALLATION TOOL KIT**

TOYOTA 後橋懸掛鐵套拆裝工具組

- This tool kit is designed to remove and install the bush of TOYOTA rear-axle suspension.



Rear axle suspension bush
OEM no. ref.:
48725 - 28050 - S



Toyota rear axle suspension



Removal:



Installation:

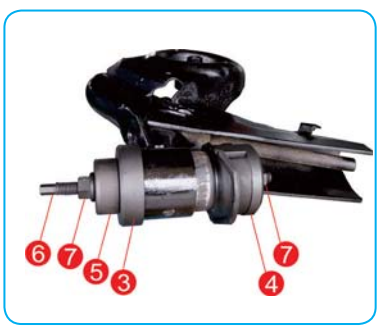

H.C.B-A2315 **NEW** **10 PCS AIR HAMMER W/AIR CHISEL KIT**

10 PCS 綜合型氣動鎚組

- Fast cutting action on mufflers and tailpipes, body panels and general repairs.
- Longer life alloy steel barrel and heat-treated piston, coil spring retainer.
- Chisels include edging tool, tail pipe cutter, straight and cutting chisels and punch



Speed (B.P.M)	2100
Piston Diameter	19 (mm)
Piston Stroke	96 (mm)
Overall Length	395
Air consumption	10 (CFM)
Air Inlet	1/4 in
Air Hose Size	3/8 in

Item	Specification	Length
1	Shape	175
2	Flat	178
3	16mm Jaw open	177
4	23mm Jaw open	177
5	φ36 Round Raised	112
6	1/2"	127
7	φ25 Curve	113
8	φ25 Flat	113
9	3/8" Drive	127
10	40x68 Half moon	100



010

HWANG CHERNG BIN
Specialty Tools Inc.

一般修護工具 引擎

GENERAL ENGINE REPAIR TOOL





010
 HWANG CHERNG BIN
 Specialty Tools Inc.

一般修護工具 引擎
 General Engine Repair Tool

H.C.B-A1081 ADJUSTABLE UNIVERSAL CAMSHAFT PULLEY HOLDING TOOL
 TW PAT. 227176 USA PAT.7069821

專利可調式皮帶盤支撐扳手

10 / 19 / 20 / 2.38"

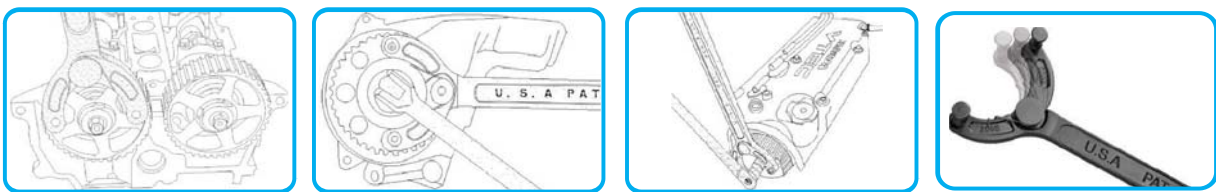
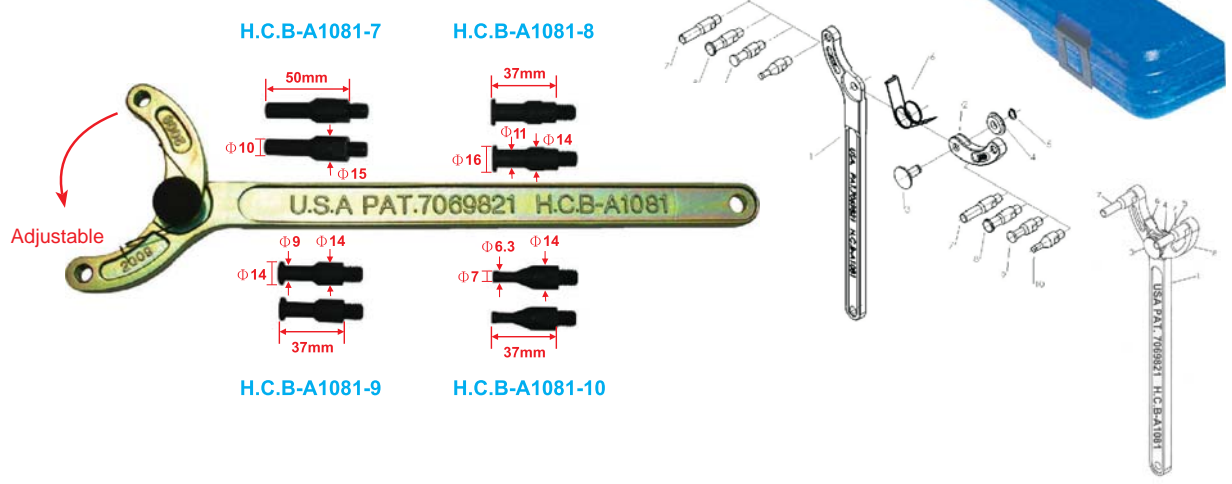

- Suitable for all kinds of engines.
- This wrench is designed with grooved pins which can hold the camshaft pulley steadily while loosening and tightening the center shaft bolt.
- It is useful to most Asian overhead cam engines, especially transverse mounted V6 engines. Such as the VG30 used in NISSAN MAXIMAS, as well as, the 3VZFE and 1MZFE engines used in TOYOTA CAMRY.
- Adjustable distance: P.C.D 21 mm-100 mm
- H.C.B-A1081-10
To hold the camshaft pulley, special for TOYOTA Hi-Ace (Euro 4).
- Application: BENZ, BMW, FORD, MITSUBISHI, HONDA, VW, AUDI, NISSAN, VOLVO, TOYOTA...etc.



CAUTION:

1. READ THE MANUAL CAREFULLY BEFORE USING!
2. THIS TOOL IS DESIGNED TO HOLD THE CAMSHAFT ONLY. IMPROPERLY USE MIGHT CAUSE DAMAGE TO THIS TOOL.
3. THIS TOOL FORBIDS USING ON CRANKSHAFT PULLEY HOLDING.

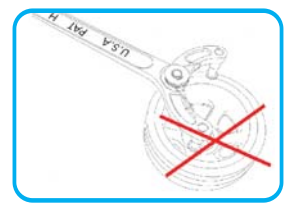

H.C.B-A1081 Won the "2009 AMPA Innovation Awards" Champion

General Engine





H.C.B-A1049

UNIVERSAL CAMSHAFT PULLEY HOLDING TOOL

皮帶盤支撐扳手

- This wrench is designed with groove pins which can hold the camshaft pulley steadily while loosening and tightening the center shaft bolt.
- Application: TOYOTA, NISSAN and other OHC engines.
- N.W.: 0.8 KGS



H.C.B-A2134

UNIVERSAL TWIN/4 CAM LOCK (GAS AND DIESEL ENGINE)

萬用雙凸輪軸 / 4 凸輪軸正時工具 (適用汽油與柴油引擎)

36 / 10.8 / 11.8 / 2.6'

- It is designed to lock twin camshafts to make timing marks during timing belt replacement.
- Fit onto sprockets and extend to lock in sprocket teeth.
- Adjustable arms to fit various diameters and tooth pitch.
- Also suitable for locking between cam and diesel injection pump sprockets.
- Operated by one person only.



H.C.B-A1388

ROVER KV6 PETROL/ROEWE 750 ENGINE TIMING KIT (13 PCS)

ROVER KV6 汽油 / ROEWE 750 引擎正時工具組 (13 PCS)

- To replace engine timing belt.
- Application: 2.0 V6 & 2.5 V6 engine. Year 1999~2005.
Rover 45 75 / 160 180 190 / 825 / MG ZS / MG ZT / AT-T / Land Rover Freelander 2.5
- Note: Not suitable for MG ZT / ZT-T 190.

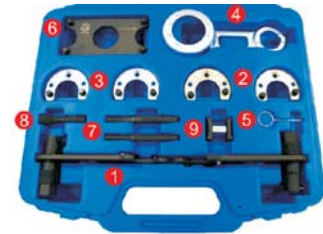

Item No.	Name	Q'ty	Engine no.	Series of car
A1388-1	Camshaft Locking Tools	2	18G 1747	
A1388-2	Cam Tool Adaptors 2.0 V6	2	12-187	2.0 V6
A1388-3	Cam Tool Adaptors 2.5 V6	2	12R208	2.5 V6
A1388-4	Rear Cam Sprocket Setting Tool	1	12-175 (not 825 206 V6)	
A1388-5	Tensioner Pushrod Retension Pin	1		
A1388-6	Rear Cam Sprocket Setting Tool	1	LRT 12-175	825 2.5 V6
A1388-7	Rear Cam Sprocket Guide Pin	2	LRT 12-198 18G 1746	
A1388-8	Crankshaft Setting Pin	1	LRT 12-232 18G 1747-5	
A1388-9	Rear Cam Sprocket Spreader	1	LRT 12-195 18G 1747-1	



H.C.B-A2198

CAMSHAFT SEAL REPLACER

凸輪軸油封拆裝器

- To replace the cam seal in 4&6 cylinder.
- Application: MAZDA, NISSAN, TOYOTA, LEXUS...etc.

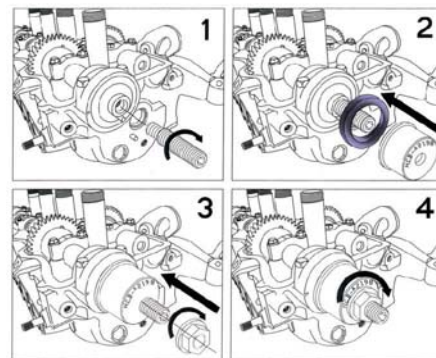

H.C.B-A2171

PETROL ENGINE CAM LOCKING/SETTING TOOL AND FLYWHEEL HOLDING TOOL KIT

汽油引擎雙凸輪軸固定工具及飛輪固定工具組

Standard Parts List	
A2171-01 Camshaft Setting/Locking Plate	
It is used to lock the camshafts in their position by way of a slot at rear of the camshafts.	
A2171-02 Balancer Shaft Locking Pin	
It purposed refitting the balancer shaft belt after renewal of the timing belt.	
A2171-03 Crankshaft TDC Location Pin	
This tool can be used on specific Ford and Mazda twin cam engines, in combination with the Camshaft Setting/Locking Plate to ensure correct TDC position.	
A2171-04 Camshaft Locking Pins (5.0mm, pair)	
A2171-05 Camshaft Locking Pins (6.8mm, pair)	
Kit supplied with two diameter-locking pins: 5.0mm and 6.8mm. Insert the correct diameter locking pins to lock each camshaft in position with the timing marks aligned to those on the casing/cover.	
Camshaft Locking Tools	
Kit contains nine different shape-camshaft locking tools for a variety of vehicles. They are inserted between the two camshaft sprockets to lock the sprockets in position firmly and prevent them from rotating out of their timed position when the timing belt is removed.	
A2171-06	A2171-07
A2171-11	A2171-12
A2171-13	A2171-14
A2171-15	A2171-16
Flywheel Holding Tools	
The pulley bolt has a high torque loading in which case the engine must be "locked" securely when releasing and tightening the bolt. The teeth-like design allows the operator to engage the flywheel teeth and the tool is bolted to the transmission housing to prevent movement of the flywheel. Suitable for Petrol and Diesel engines.	A2171-17
	A2171-18
Applications	
A2171-01	A2171-14
Ford: Fiesta 1.25, 1.4(95-), 1.8 XR2i/Rs 1800 16V, Mondeo 1.6, 1.8, 2.0 16V (93-) Mazda: 121.1.25.	Land Rover: Discovery MPI 2.0 16V (93-), 20T4 engine Rover: 220 M16 (-92), 220/Turbo T16 (92-), 420 M16 (-92), 420 T16(92-), 320/Turbo M16 (-91), 620Ti (94-), 820/Turbo T16 Vitesse Turbo (91-)
A2171-02	A2171-16
Ford: Honda: Accord/Prelude 2.3i (93-), Prelude 2.2 V-Tec, SOHC application: Accord 1.8, 2.0, 2.2 (-93), 2.0i(93-), Shuttle 2.2i	Works on: VOLKSWAGEN BORA, GOLF, LUPO AND POLO TDi'S
A2171-03	A2171-17
Ford: Escort/Orión 1.6, 1.8i 16V(92-) Mazda: 121.1.25.	Vauxhall/Opel: 1.2, 1.4, 1.6, 1.8, 2.0 OHC Petrol engines 1.6D & 1.7 OHC Diesel engines 1.5 & 1.7 OHC Diesel(Isuzu) engines
A2171-04	A2171-18
Ford: Honda: Civic 1.6 VTI Accord (90-), Prelude 2.0 16V (-90) Rover: 216, 416, GTi 16V(-95) D16A9 engine	Citroen: Synergie 2.0/Turbo, ZX 1.9D/TD, Xantia 1.9D/TD, Berlingo 1.9D, Dispatch 1.9D/TD, Synergie 1.9D, Relay 1.9D/TD



A2171-05	Fiat: Ulysse 2.0/Turbo, Ducato 2.0 FSO 1.9D LDV: 200 1.9D, Pilot 1.9D
A2171-06	Rover: 220/Turbo T16 (92-), 420 T16 (92-), 320/Turbo M16 (-91), 820/Turbo T16 Vitesse Turbo (91-), 620 Ti (94-), SOHC application 820 8V (M8) Land Rover: Discovery MPI 2.0 16V (93-), 20T4 engine
A2171-07	Peugeot: 205 1.6/1.9, 305 1.6/1.9, 309 1.6/1.9 405 1.6/1.9, 405 1.8/2.0 (92-), 605 2.0 Boxer 2.0, c205 1.8/1.9D, 305 1.8/1.9D, 306 1.8/1.9D/TD Vauxhall/Opel: Vauxhall Cavalier 2.5i, Calibra 2.5i, Vectra 2.5, OMEGA 2.5/3.0L, Sintra 3.0L SAAB: 900 2.5, 9000 3.0 V6
A2171-08	Vauxhall/Opel: Vauxhall Cavalier 2.5i, Calibra 2.5i, Vectra 2.5/3.0L, Sintra 3.0L SAAB: 900 2.5, 9000 3.0 V6
A2171-09	For Rover K16 DOHC engines
A2171-10	ECOTEC suitable for 16V 1.4/1.6L engines
A2171-11	ECOTEC suitable for 16V 1.8/2.0L engines
A2171-12	Vauxhall/Opel: Astra 1.8/2.0 16V, Cavalier 2.0 16V, Calibra 2.0 16V/Turbo Omega-B 1.4/1.6 16V, Later engines (93-) with small cam sprockets
A2171-13	Vauxhall/Opel: Astra 2.0 16V, Cavalier 2.0 16V, Calibra 2.0 16V, Early engines (-92) with large cam sprockets.
A2171-14	Renault: R5 1.6D, R9 1.6D, 411 1.6D Express/Extra 1.6D - F8M Diesel engines Clio, Express/Extra, R19 1.9D - early F8Q Diesel engines Espace 2.1D, R21 2.1D, R25 2.1D, Trafic/Master 2.1D - J8S Diesel engines Clio 1.2/1.4, Express/Extra, R19 1.4, Megane/Scenic 1.4/1.6 - E7F/E7J Petrol engines R5 1.7, Clio 1.7/1.8, R19 1.7, R21 1.7, Megane/Scenic 2.0 Laguna 1.8/2.0, Trafic 1.7 - F3N/F3P/F2R Petrol engines Clio Williams, R19, Megane 2.0 16V Twin cam F7P/F7R engines Laguna/Safrane 2.0 16V Twin cam N7Q/N7U engines
A2171-15	Rover: Metro GTa/GTi 16V K16 (-95), 214, 414 K16 (89-) 216, 416 K16 (95-), MGF 1.8 MPI/VVC (95-)

H.C.B-A4001

RENAULT TIMING TOOL KIT

雷諾正時工具組



- To adjust RENAULT engines' timing.
- Application:
Clio 1.2/ 1.4, Clio 1.4/ 1.6/ 1.8 16V, Clio Sport 2.0 16V, Clio Williams 2.0 16V
Espace 2.0, Espace 2.0 16V, Espace 2.2 TD
Express 1.4
Extra 1.4
Kangoo 1.2/ 1.4
Laguna 1.6 16V, Laguna 1.8/2.0, Laguna 1.8/ 2.0 16V, Laguna 2.2 D/TD, Laguna 2.5 D/ TD
Master 2.5 D/ TD
Megane 1.4/ 1.6/ 2.0 16V
R19 1.4, r19 1.4 Eco, R19 1.8 16V
Rapid 1.4
Safrane 2.0 16V, Safrane 2.2 TD, Safrane 2.5 20V
Scenic 1.4/ 1.6/ 2.0 16V
Trafic 2.5C
Twingo 1.2



010
HWANG CHERNG BIN
 Specialty Tools Inc.

SINCE 1990

General Engine



H.C.B-A4002

SETTING/LOCKING TOOL KIT FOR VAG, V6, TDI, PETROL ENGINE

VAG, V6, TDI 柴油引擎正時工具組

12 / 12.5 / 13.5 / 1.3'

- To set, lock, support and adjust tensioner of VW 2.5 V6 diesel engines.
- Application: VW 2.5 TDi V6 diesel engine. VW Passat AFB / AKN. Audi A4, A6 and A8.



H.C.B-A4004

CITROEN & PEUGEOT ENGINE TIMING TOOL KIT

雪鐵龍 & 標緻引擎正時工具組

5 / 20.5 / 21.5 / 1.9'

- For engine timing when replacing the timing belt.
- Suitable for most of recent cars with HPI (petrol) or HDI (diesel) engines.
- Applicable to Peugeot and Citroen for locking the flywheel / camshaft / crankshaft, removing the assembly of fuel injection pump and water pump, and changing the timing belt
- Also suitable for identical engines in Fiat, Ford, Nissan, Renault, Rover, Toyota...etc.
- Suitable for:
 Petrol engines:
 1.9 - 1.1 - 1.4 - 1.6 - 1.8 - 1.9 - 2.0
 1.6 - 1.8 - 2.0 - 2.2 16V (Turbo and twin camshaft)
 Diesel engines:
 1.4 - 1.5 - 1.7 - 1.8 - 1.9 - 2.1 - 2.5 D / TD / TDI
 1.4 - 1.6 - 2.0 - 2.2 HDI



H.C.B-A4005

VAUXHALL/OPEL ENGINE TIMING TOOL

VAUXHALL/OPEL 引擎正時工具組

- To lock the camshaft and crankshaft, remove and assemble fuel injection pump and water pump, and change the timing belt.
- Also suitable for identical engines in Saab, Renault...etc.
- Diesel engines: 1.3 CDTi 16V, 1.9 CDTi, 2.0 DTi, 2.2 DTi.
- Application: Agila, Astra, Combo-C, Corsa, Frontera, Omega, Signum, Sintra, Tigra, Vectra and Zafira.



H.C.B-A4006

TIMING LOCKING TOOL KIT (8 PCS)

正時工具組 (8 PCS)

10 / 10.1 / 11.1 / 1.1'

- ★ Aluminum plates with different colors, suitable for locking camshaft pulleys on twin cam engines.

■ A4006-1:

VAUXHALL / OPEL: ASTRA G 1.7 TD
ASTRA-G 2.0 16V
VECTRA 1.8/ 2.0 16V < 95

■ A4006-2:

VAUXHALL / OPEL: ASTRA G 1.4/ 1.6/ 1.8 16C < 94
VECTRA 1.6/ 1.8 16V
ZAFRIA 1.6/1.8 16V

■ A4006-3:

Right side camshaft SAAB:900 · 9000
VAUXHALL / OPEL: CALIBRA 2.5/2.5i/2.6 V6
CAVALIER 2.5i V6
OMEGA-B 2.5/ 2.6/ 3.0/ 3.2 V6
SINTRA 3.0 V6
VECTRA-A 2.5/ 2.5i/ 2.6 V6

■ A4006-4:

Left side camshaft SAAB:900 · 9000
VAUXHALL / OPEL: CALIBRA 2.5/ 2.5i/ 2.6 V6
CAVALIER 2.5i V6
OMEGA-B 2.5/ 2.6/ 3.0/ 3.2 V6
SINTRA 3.0 V6
VECTRA-A 2.5/ 2.5i/ 2.6 V6

■ A4006-5:

ROVER:25 1.4/ 1.6/ 1.8/ VVC, 45 1.4/ 1.6/ 1.8
75 1.8, 200 VI, 214 16V
216 16V / CABRIO / COUPE
218 COUPE, 414 16V, 416 16V / TOURER
BRM 1.8VVC, METRO GTI/GTA 16V
MGF 1.8VVC, Most models

■ A4006-6:

VOLKSWAGEN: BORA 1.9 TDI, GOLF 1.9 TDI
LUPO 1.2/ 1.4/ 3.0 TDI, POLO 1.4TDI
PASSAT 1.9 TDI

■ A4006-7:

CITROEN: BELLINGO 1.9D, DISPATCH 1.9D/
TD, FSO 1.9D
RELAY 1.9D/ TD, SYNERGIE 1.9/ 2.0T, XANTIA
1.9/ 2.0 D/ TD/ HDI
XSARA 1.9/ 2.0D/ HDI, ZX 1.9 D/ TD, Most of
diesel
FIAT:DUCATO 2.0D · ULYSSE 1.8/ 2.0 TURBO
FORD: Most of diesel
PEUGEOT: 205 1.6/ 1.8/ 1.9D · 305 1.6/ 1.8/
1.9D · 306 1.8/ 1.9 D/ TD 309 1.6/ 1.9 · 405
1.6/ 1.9D · 406 1.9D, 605 2.0 D/TD 806 1.9TD,
BOXER 1.9/ 2.0 D/TD, EXPERT 1.9D, PARTNER
1.9D
TALBOT: EXPRESS D, HORIZON D, J5 D,
SOLAKARA D

■ A4006-8:

ISUZU: 1.5/ 1.7 diesel engines
VAUXHALL / OPEL:1.6/ 1.7 diesel engines
1.2/ 1.4/ 1.6/ 1.8/ 2.0 OHC petrol engines



H.C.B-A4007

FORD & MAZDA ENGINE TIMING TOOL KIT

福特 & 馬自達引擎正時工具組

- Comprehensive engine timing tool kit covers most engines in the Ford range including both petrol and diesel and the latest Zetec engines.

- It also includes special pins required to lock the camshaft sprocket, flywheel and align the crankshaft and fuel pump when checking the valve timing on 2.0 & 2.4 L chain driven engines and or replacing the timing belt on 1.4 L engines.

- Application: Engine codes:

DHA, DHB, DHC, DHD, DHE, DHF, DHG, FHA,
FHB, FHF, FXDA/C, DXDB/D, FYDA/C, FYDB/D,
FYDH, LIT, LIV, LIW, M7JA, M7JB, D5BA, D6BA,
FMBA/BTransit: D2FA, D4FA, F4FA.





H.C.B-A4008

FIAT 1.9D/TD ENGINE TIMING TOOL KIT

FIAT 1.9D/TD 正時工具組

- For Fiat 1.9d/TD with Peugeot engines:
Punto 1.9D | Brava | Bravo 1.9D Turbo | Marea | Weekend 1.9d Turbo, Punto 1.9 JTD | Brava | Bravo 1.9 JTD | Marea | Weekend 2.4 JTD | Multipla 1.9 JTD 1996< Marea 2.4D Turbo | Marea Weekend 2.4D Turbo and Alfa Romeo/Fiat 1.9 PSA derived D and TD engines.

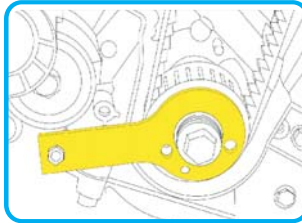

- Including Alfa Romeo 145 | 146 | 156 JTD.

H.C.B-A4009

RENAULT/VAUXHALL/OPEL/NISSAN DIESEL ENGINE TIMING TOOL KIT

RENAULT/VAUXHALL/OPEL/NISSAN 柴油引擎正時工具組

- For Renault 2.0DCi chain drives diesel engines fitted to the Megane | Vel Satis | Espace | Scenic | Trafic | Laguna | Koleos, also fitted to the Nissan Qashqai and the Vauxhall | Opel Vivaro.

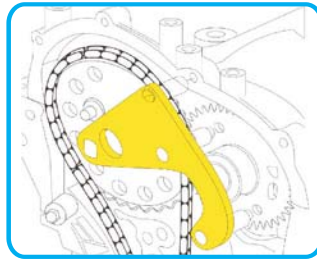

- Engine code M9R.
- OEM no. ref.:
EN48334, EN48332, EN48331, EN48330

H.C.B-A4010

RENAULT/VOLVO 2.0 16V ENGINE TIMING TOOL KIT

RENAULT/VOLVO 2.0 16V 引擎正時工具組

Models:

- Renault Laguna 2.0 16V/ 2.5 20V (1996-1999)
- Renault Laguna 2.0 16V/ 2.5 20V (1996-2001)
- Model Laguna (96-99), Safrane (96-01)
- Engine: N7Q 704/710/711 (2.0 16V), N7U 700/701 (2.5 20V)
- Volvo 850 (1992-1997), C70 (1998-2002), S40 (1996-2004), V40 (1996-2004), Volvo S60 (2001-2005), S70 (1997-2000), S80 (1999-2005)
- Engine Codes:
Volvo: B4164S, B4164S2, B4184S, B4184S2, B4184S3, B4184S9, B4184S10, B4194T, B4194T2, B4204S, B4204S2, B4204T, B4204T2, B4204T3, B4204T5, B5202Fs, B5204FT, B5204T2, B5204T3, B5204T4, B5204T5, B5234FS, B5204FT, B5234T3, B5234T4, B5234T5, B5234T6, B5234T7, B5234T8, B5234T9, B5244S, B5244S2, B5244SG, B5244SG2, B5244T, B5244T3, B5244T4, B5244T5, B5244T7, B5252FS, B5254T, B5254T2, B5254T4.



Parts No.	OEM no. ref.	Description
1	MOT 1337	Camshaft Setting Tool
2	MOT 1348	Tensioning Tool
3	MOT 1340	Crankshaft TDC Timing Pin

H.C.B-A4011

CITROEN / PEUGEOT ENGINE TIMING TOOL KIT

雪鐵龍 / 標緻引擎正時工具組

- A range of timing tools for the latest EW coded PSA engine used on Citroën Xsara | Picasso | C5 | C4 | Evasion | Synergie | C8 | Jumpy | Dispatch and Peugeot 206 | 307 | 406 | Coupe 607 | 806 | 807 | Expert Engine Codes EW12J4(3FC) | EW10D-HPI(RLZ) | EW10J4S(RFK) | EW10J4(RFN/RFR) | EW7J4(6FZ).
- Engine Codes EW12J4 (3FC) | EW10D-HPI(RLZ) | EW10J4S(RFK) | EW10J4(RFN/RFR) | EW7J4(6FZ).
- EW is the prefix used on the vehicles engine number.
- A 3 digit code in the chassis number identifies the engine used in the vehicle.



H.C.B-A4012

CITROEN / PEUGEOT ENGINE TIMING TOOL KIT

雪鐵龍 / 標誌正時工具組

- This comprehensive tool kit enables the correct engine timing to be made when replacing the timing belt.
- Suitable for using on the modern cars with either HPI (petrol) or HDI (diesel) engines.
- Citroen: AX, BX, ZX, XM, Visa, Saxo, Xsara, Xantia Synergie / Evasion, Berlingo, Jumpy, C15, C25, Picasso, C5.
- Peugeot: 106, 205, 305, 306, 307, 309, 405, 406, 605, 607, Expert, Partner, Boxer.

■ **OEM no. ref.:**

4507-TJ | 0132X | 0132X1Z | 9767.89 | 0132Q | 5711-TA | 0132R | 4507-TB | 9767.27 | 7014-TM | 0132QZ | 4507-TA | 0189C | 0153G | 0153N | 0188D | 0153Y | 7004-TG | 7014-TJ | 7017-TR | 9767.34 | 7017-TR | 0153N | 0188D | 0288D | 7099-TM | 0188X | 0118X | 0189R | 0189S1 | 0189S2 | 0195K | 0196C | 0195H | 0188AH | 0188AD | 0132AB | 4527-TS2 | 5711-TD | 0118X | 0188H | 0189B | 4527-TS1 | 0132AJ1 | 4533TAC1 | 0133AJ2 | 0188M | 4533-TAC2 | 5711-TC | 9041-TZ | 0189A | 0189AZ | 0189L | 0178E | 0188/J1 | 5711-TE | 0134AF | 0188F | 9044-T | 0188J2 | 7017-TW | 0132AK | 0153AK | 0187J | 0188K | 0189K | 4533-TAD | 0188P | 0174 | 7015-T | 0188P2 | 1 860 639 000 | D86 | 0153A | 6012T | 9765-54



H.C.B-A4014

VAUXHALL DIESEL SETTING/LOCKING TOOL KIT

VAUXHALL 柴油引擎正時工具組

- Cover timing belt replacement on the current range of Renault DCi common rail diesel engines.
- Updated kit suitable for Clio 2 1.5dCi + 1.9dCi 600/800 series engines.
- To prevent the engine shafts (camshaft, crankshaft) from turning belt tensioner when changing a timing belt or during other engine repairs.
- Application:

Models:

Micra K12 (03-09)
Almera N16 (02-06)
Note E11(06-09)
Qashqai J10(07-09)
Primera P12 (03-07)
Kubistar X76 (03-09)
Primastar (02-07)
Interstar (02-06)

Engines:

1.5DCI K9K: 260/270/272/274/276/702/704/710
1.9DCI F9Q: 760/762/772/774
2.2DCI F9Q: 722/750
2.5DCI G9U: 720/724/726/750/754



Also for RENAULT and VAUXHALL/OPEL models





H.C.B-A1643

NEW

PSA/PEUGEOT/CITROEN 1.0/1.2 VVT PETROL ENGINE TIMING TOOL KIT

PSA/PEUGEOT/CITROEN 1.0/1.2 VVT 汽油引擎正時工具組

Layout no.	Description	OEM no. ref.
1-8	Camshaft Timing Assembly	0109-2A
9	Crankshaft Timing Pin	0109-2B



- Designed to hold the camshafts and crankshaft in their timed position during belt replacement.
- Applications:
Citroen C3 (III)/DS3/DS3 Cabrio/C-Elysee and Peugeot 2008/208/308&latest generation Citroen/Peugeot EBO & EB2 1.0L and 1.2L 3 cylinder engines.
- Peugeot: 208, 2008.
- Citroen: C3 (III).
- Engine: 1.0 VTI, 1.2 Vti.
- Engine codes: EBO (ZMZ), EB2 (HMZ).

Manufacturer	Model	Displacement	Fuel	Engine Code	Year
Citroen	C3 III	1.0 L	Petrol	ZMZ (EBO)	2012
	C3 III	1.2 L	Petrol	HMZ(EB2)	2012
	DS3/DS3 Cabrio	1.2 L	Petrol	HMZ(EB2)	2013
	C-Elysee	1.2 L	Petrol	HMY (EB2M)	2012
Peugeot	2008	1.2 L	Petrol	EB2 (HMZ)	2013
	2008	1.2 L	Petrol	EB2 (HMZ)	2013
	2008	1.2 L	Petrol	EB2 (HMZ)	2013
	208	1.0 L	Petrol	EBO (ZMZ)	2012
	208	1.2 L	Petrol	EB2 (HMZ)	2013
	208	1.2 L	Petrol	EB2 (HMW)	2012
	208	1.2 L	Petrol	EB2 (HMZ)	2012
	208	1.2 L	Petrol	EB2 (HMZ)	2012
	308	1.2 L	Petrol	EB2 (HMZ)	2013
308	1.2 L	Petrol	EB2DTS (HNY)	2014	

H.C.B-A1571

VAUXHALL/OPEL/CHEVROLET/SAAB/ALFA/FIAT PETROL ENGINE TIMING TOOL KIT

科魯茲 / 飛雅特 / 歐寶汽油引擎工具組

- Application:
Vauxhall, Opel: Corsa-D, Agila, Astra-G-H, Meriva, Zafira-B, Vectra-C, Signum, Insignia
Engine: 1.6, 1.8 L
Engine codes: Z16LEL, Z16LER, Z16LET, Z16XE1, Z16XEP, Z16XER, A16XER, 18XER, A18XER, 2HO/A18XEL
Chevrolet: Aveo, Cruze, Orlando
Engine: 1.4, 1.6, 1.8 L
Engine codes: G14D, LDD, LXV (F16D4), 2HO(Z18XER)
Alfa Romeo: 159
Fiat: Croma
Engine: 1.8 L
Engine codes: 939A4.000



Item no.	OEM no. ref.	Description
1	KM 6628A	Camshaft Locking Bar
	2 000 012 000	
2	KM 6340	Camshaft Pulley Locking Tool(2)
	2 000 012 100	
3	KM 6625	Flywheel Holding Tool
	2 000 012 800	
4	KM 6130	Tensioning Pin
	KM 6349	
5	KM 6333	Tensioner Locking Pin
6	KM 911	Flywheel Locking Tool
7	KM 652	Flywheel Locking Device

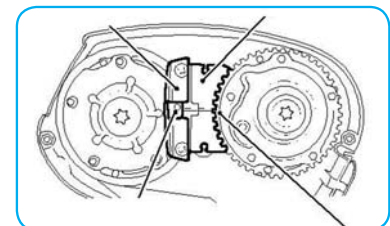

H.C.B-A1543 CUMINS TIMING TOOLS

CUMINS 正時工具組

- This Cumins barring tool is used to rotate the engine by inserting it into a port located on the bell housing/engine adapter plate.
- It provides an easy way to rotate the engine for valve adjustments or injection pump timing.
- Features a 3/8" female square drive.
- Cumins OEM no. ref.: 3824591/4919663/4919107

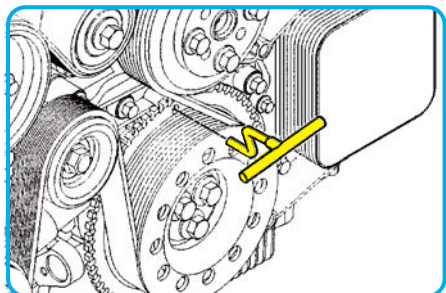
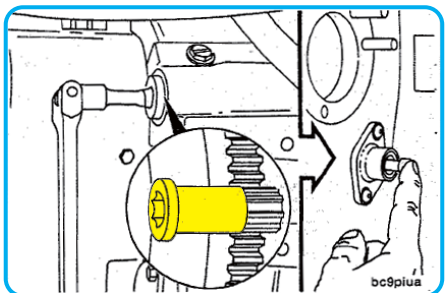

H.C.B-A2214 OPEL 2.2 16V TWIN CAM TIMING TOOL KIT

OPEL 2.2 16V TWIN CAM 引擎正時工具

5 / 6 / 6.6 / 1.5'

- To lock or position the camshaft and the timing chain tensioner during engine repairs.
- To remove and install the water pump. It is necessary to lock the water pump belt pulley by means of the tool.
- Kit for engine timing when carrying out cylinder head work and water pump replacement without the timing chain being disturbed for 2.2 chain drive Vauxhall / Opel engines.
- Application: Opel Twin Cam 2.2 16V petrol engines Astra, Signum, Speedster, Vectra and Zafira etc.

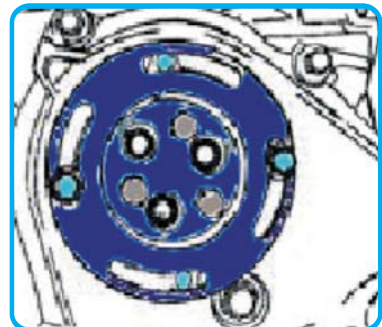
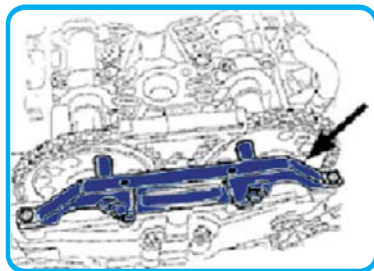



H.C.B-A2216

FIAT/ALFA ROMEO/LANCIA TIMING TOOL KIT

飛雅特 / 愛快羅密歐 / 蘭吉雅正時工具組

5 / 8.4 / 9.4 / 1.86"

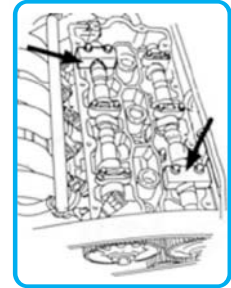

Part No.	Cylinder	Cams	Color	Q'ty	Applicable
A2216-A	2	A	Black	1	Fiat Bravo, Brava, Lancia Y10 1,4 12V
A2216-B1	3	A	Sliver	1	Lancia K5 cylinder 2.0 20V VIS engine before 1996
A2216-B2	2	S	Sliver	1	Lancia K5 cylinder 2.0 20V VIS engine before 1996
A2216-F1	3	A	Green	1	Lancia 4 cylinder VIS engine
A2216-F2	2	S	Green	1	Lancia 4 cylinder VIS engine
A2216-G1	2	A	Dark Gary	1	Fiat Coupe, Fiat Barchetta, Lancia
A2216-G2	3	S	Dark Gary	1	Alfa Romeo 1800 16V 130CV
A2216-H1	3	A	Pink	1	Fiat Bravo, Fiat Brava, Fiat Marea
A2216-H2	2	S	Pink	1	Fiat Marea 2.0 20V
A2216-I1	2	A	Purple	1	Alfa Romeo 145, 146, 147, 156 1600 16V Step A
A2216-I2	3	S	Purple	1	Alfa Romeo 145, 146, 147, 156 1600 16V Step A
A2216-L1	2	A	Dark Brown	1	Alfa Romeo 145, 146, 155 1400 /1600 e, 1400 16V Step A
A2216-L2	3	S	Dark Brown	1	Alfa Romeo 145, 146, 155 1400 /1600 e, 1400 16V Step A
A2216-M1	2	A	Light Blue	1	Alfa Romeo 156 1800~2000 16V
A2216-M2	3	S	Light Blue	1	Alfa Romeo 156 1800~2000 16V
A2216-N1	2	A	Smoke Gray	1	Alfa Romeo 147 105CV
A2216-N2	3	S	Smoke Gray	1	Alfa Romeo 147 105CV
A2216-P1	2	A	Light Green	1	Alfa Romeo 147, 156, 166 GTV Spider GT 2000 JTS 16V 165CV
A2216-P2	3	S	Light Green	1	Alfa Romeo 147, 156, 166 GTV Spider GT 2000 JTS 16V 165CV
A2216-Q1	2	A	Bronze	1	Fiat Coupe, Fiat Barchetta, Lancia Delta, Lanica Dedra Step A
A2216-Q2	3	S	Bronze	1	Fiat Barchette, Fiat Punto HJTALFA 1800 16V 132CV
A2216-R1	3	A	Gold	1	Alfa Romeo 147 160 eco 103CV
A2216-R2	2	S	Gold	1	Alfa Romeo 147 160 eco 103CV
A2216-13				1	To remove / rotate aspiration phase transformer
A2216-14				1	TDC tool

H.C.B-A2199

RENAULT ENGINE TIMING TOOL KIT

雷諾引擎正時工具組

5 / 13 / 13.5 / 1.59"

- This new camshaft pulley setting tool holds two pulleys in place while changing the cam belt and correct engine timing to be performed when changing the timing belt.

- Application: RENAULT 16V & K4J, K4M & F4P, F4R. And petrol 1.4, 1.6, 1.8, and 2.0 L engines.



H.C.B-B2199

RENAULT ENGINE TIMING TOOL KIT

雷諾引擎正時工具組

- This new camshaft pulley setting tool holds two pulleys in place while changing the cam belt and adjust engine. Timing to be performed when changing the timing belt.
- Application: Renault, 16V & K4J,K4M & F4P,F4R.
1.4 16V K4J.
1.6 16V K4M.
1.8 16V F4P & F4R (langunall)



H.C.B-A2123

UNIVERSAL CAMSHAFT ALIGNMENT TOOL

圓孔型雙凸齒輪固定器

- By using sockets to lock onto camshaft central screw.
- Adjustable to fit most kinds of vehicle.
- Special design to align camshaft and remove or install the guide rail pin.



H.C.B-A2221

UNIVERSAL CRANKSHAFT/CAMSHAFT SEAL REMOVER/INSTALLER KIT

萬用凸輪軸 / 曲軸油封拆裝工具組

10 / 18 / 19 / 1.8'

- To replace crankshaft / camshaft seal without dismantling the crankshaft / camshaft case.
- Save your time and cost. Do not worry about scraping the crankshaft / camshaft surface.
- Apply for wide range of cars with oil seals, the diameter between 27 mm and 58 mm.
- Use the existing bolt in the vehicle for installation.
- Screw-type adapter to fit the centering.
- The blue seal adapters are made of aluminum to prevent damage from crankshaft / camshaft.

Note: Some camshaft seals have screws to prevent removing.
Do not use this tool by force.



H.C.B-A1189

GEAR PULLER (THIN JAWS)

曲軸正時皮帶盤拆裝工具組 (薄爪)

24 / 18.5 / 19.5 / 1.41'

- Special puller with ultra thin jaws for removal of crankshaft timing gear.
- Depth: 100 mm.
- Outside: 40-90 mm.

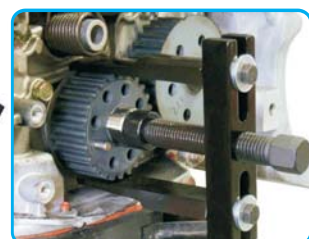



H.C.B-A1143

CHRYSLER CRANKSHAFT PULLEY REMOVER/INSTALLER

克萊斯勒皮帶盤拆卸器



- Two tools are combined in one! On car maintenance. This tool is necessary when servicing the crankshaft pulley on 1981 and newer CHRYSLER cars.
- It removes / installs the crank gear while the engine is still installed on the vehicle.
- No damage to either the gear or crankshaft.

H.C.B-B1143

CHRYSLER CRANKSHAFT PULLEY REMOVER/INSTALLER

克萊斯勒皮帶盤拆卸器



H.C.B-A1115

UNIVERSAL CRANKSHAFT PULLEY & CAMSHAFT PULLEY PULLING AID PAT. M 253504

可換式皮帶盤拆卸組

5 / 15.4 / 16 / 0.74'

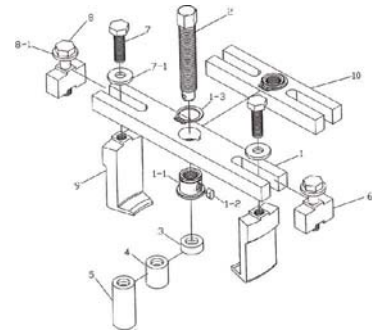
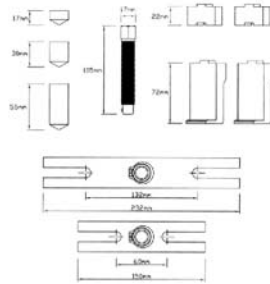

- The kit contains a range of long and short identities, bolt, C-ring, replaceable nut, key, screw, washer, extending block, claw, and center pushing rod.
- This kit is useful when the crankshaft pulley and camshaft pulley get stuck.
- The bolt, C-ring, replaceable nut and key are designed to insert into the identity for removing and installing the crank shaft pulley and camshaft pulley.
- The screw, washer, extending block, and claw are designed to fix on the extremities of the identity.
- The center pushing rod is to fasten the replaceable nut and the key.
- Special bolt with rolling bead is designed to protect the C-ring from being broken.
- The long and short identities, center pushing rod, and screw are universal according to the size of crank shaft pulley and camshaft pulley during operation.
- The extending block could extend the length of the claw according to the height of pulley, so as to protect the pulley from damage.
- The bolt and groove of bolt's hole are replaceable while broken instead of replacing identity itself.
- The long and short identities are time and money saver.
- Two sizes for the identity:
 - Long: 17 x 36 x 232 L
 - Short: 17 x 36 x 150 L
- Two size for the screw:
 - Long: M10 x P1.5 x 50 L
 - Short: M10 x P1.5 x 30 L
- Three sizes for the center pushing rod:
 - Long: $\varnothing 22 \times 55$ L
 - Middle: $\varnothing 22 \times 30$ L
 - Short: $\varnothing 22 \times 17$ L

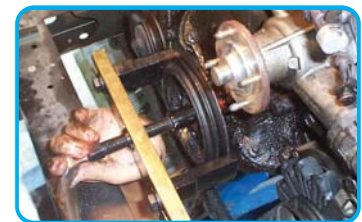

H.C.B-A2179

ON CAR

UNIVERSAL CRANK PULLEY HOLDING PLATE

固定式曲軸皮帶盤拆裝組

25 / 25 / 26 / 0.6'

ON TOYOTA CAR



1. Pulley holding



2. Pulley removal/installation



3. Pulley removing

- This tool is designed to hold the camshaft pulley steadily while loosening and tightening the center shaft bolt.
- Using the central threaded rod to uproot the pulley.
- Locking screw: M6, M8.

Part No.	Part Name	Size (mm)	Q'ty	Material	Hardness
1	Main Body	L 134 x W 50 x H 16	1	SCM440	HRC 40 - 45°
2	Nut	H 24 x D: M40 x P 1.5 x d: M16 x P 2.0	1	S45C	HRC 40 - 45°
3	Bolt	H 17 x Ø M 16 x P 2.0 x L 105	1	S45C	HRC 45 - 50°
4	Center Pushing Rod	Ø 22 x L 17	1	S45C	HRC 35 - 40°
5	Screw	M 8 x P 1.25 x L 68	2	SCM	HRC 35 - 40°
6	Screw	M 6 x P 1.0 x L 46	2	SCM	HRC 35 - 40°
7	Washer	D: 13 x d: 6.1	2	S45C	HRC 30 - 35°

H.C.B-A1440

MAZDA 3/MAZDA 5/FORD FOCUS AIR CONDITIONING COMPRESSION BELT INSTALLER

MAZDA 3/MAZDA 5/FORD FOCUS 冷氣壓縮機皮帶安裝器

- To fasten the belt when installing the belt.
- Application : MAZDA 3/ MAZDA 5/ FORD FOCUS.

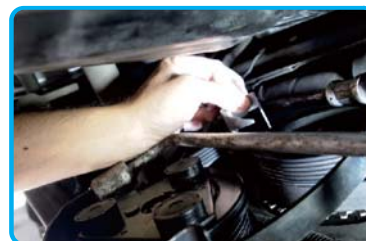

H.C.B-A2243

BELT INSTALLING TOOL KIT

皮帶安裝工具組

- This tool kit can quickly and easily remove and install the new elastic ribbed belts.
- Special designed kit for installing the new belt onto the pulley.
- Application: Alfa Romeo, BMW, Chrysler, Fiat, Ford, Mercedes, PSA, Seat, Skoda, Smart, Volvo, VW-Audi, Mazda, Lancia, Citroen, etc...





H.C.B-A1054-2

UNIVERSAL SEPARATOR (R2) PAT. 172921

萬用拆卸器 (R2)

12 / 17.7 / 20.5 / 1.05"

- Multi-purpose puller set for balancer, puller & gear.
- Screw specification: M8 x P1.25 x 3 PCS, M10 x 1.5 x 3 PCS.
- Application: FORD R2 diesel engine 2000 C.C., TOYOTA crankshaft pulley, LEXUS GS 300(1999-2004).
- N.W.:1.47KGS.
- G.W.:1.62KGS.



H.C.B-A1054-2 on LEXUS GS300 (1999-2004)



H.C.B-A1054-4

STEERING WHEEL PULLER BOLT (EXTENDED)

方向盤拆卸器螺絲 (加長型)



H.C.B-A1157

GEAR TYPE ENGINE MOUNTING BRACKET

齒輪式引擎拆裝架

1 / 65 / 70 / 12'

H.C.B-A1157-1

MULTIPLE FUNCTION TABLE GEAR-TYPE ENGINE MOUNTING BRACKET

多用途桌上型引擎拆裝架

- Apply to all kinds of vehicles' engines . It can be disassembled and mounted on the table for engine maintenance.
- Gear-type drive makes it 360°rotatable to offer multiple angles of position for maintenance.
- It can be combined with H.C.B-A1117-4 or H.C.B-A1097-5 to dismantle and assemble all kinds of transmissions overhaul.
- Best tool for engines and transmissions overfull.



H.C.B-A1157-2

FIXING BASE

固定式底座

- Four wheels with brake mechanism makes it stable during holding engine or transmission.

H.C.B-A1157-3

SLOP OIL PAN

廢油盤

- Special design makes it light-weight and handy. With two handle bar, it is easy to handle waste oil.



H.C.B-A1157-1

H.C.B-A1157-2

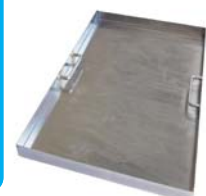

H.C.B-A1157-3



010
HWANG CHERNG BIN
Specialty Tools Inc.

一般修護工具 引擎
General Engine Repair Tool

H.C.B-A1097 UNIVERSAL GEAR TYPE ENGINE K/D RACK USA PAT. PEN PAT.089901

齒輪式引擎拆裝架

- Rotating engine by gear which can assemble & disassemble engines more convenient and labor-saving.
- Small volume, store up very easy.
- DIM. 34.5 x 40 x 43.5 cm
- N.W.: 29.5 KGS

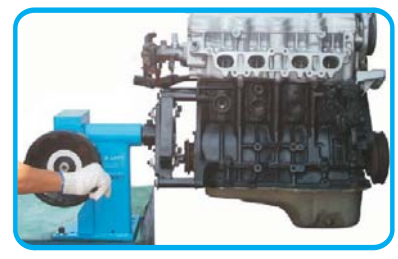

General Engine



H.C.B-A2014 FOLDABLE ENGINE CRANE (1 TON)

1 噸引擎吊架

1 / 81.1 / 96.6 / 22.49'

- This tool is designed to hang up the engine.
- Fast folding for easy storage and transportation.

Foldable



H.C.B-A2014-1 8 TONS HYDRAULIC JACK, LONG RAM

8 噸千斤頂

- This jack can easily handle lift jobs up to 8 tons.
- An ideal jack for hydraulic craning, engine hoisting and has a wide variety of other applications.





H.C.B-B2014

UNIVERSAL ENGINE LIFTING BRACKET

萬用發動機維修起吊支架

- Combine with A2014.
- Capacity: 600 KGS



H.C.B-A2016

ENGINE STABILIZER BAR

引擎平衡桿 (固定架)

2 / 24.4 / 27 / 2.27'

- Stand on the inner walls and act as a bridge to support engines.
- The bridge is adjustable in high and width to fit all vehicles fender walls and securely hold engine including slider bolt that can be positioned anywhere on the bar for best weight distribution.
- Specification: W 1500 mm x H 45 mm

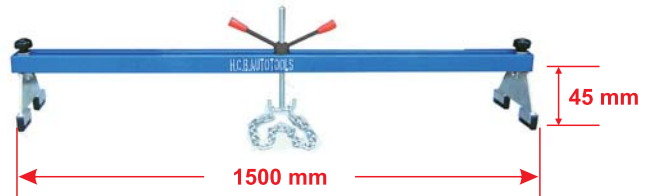

H.C.B-B2016

ENGINE STABILIZER BAR (EXTENDED FIX BASE)

引擎平衡桿 (加高型固定架)

2 / 29 / 33 / 2.27'

- With extended fix base, it can stand on more kinds of vehicles' fender walls.
- With two hooks and two chains (attached), it is good for securely hoisting all kinds of engines and transmission.
- Specification : W 1500 mm x D 247 mm x H 270 mm



H.C.B-C2016 UNIVERSAL TRANSVERSE ENGINE STABILIZER BAR

萬用可調式引擎平衡桿

2 / 28 / 32 / 2.45'

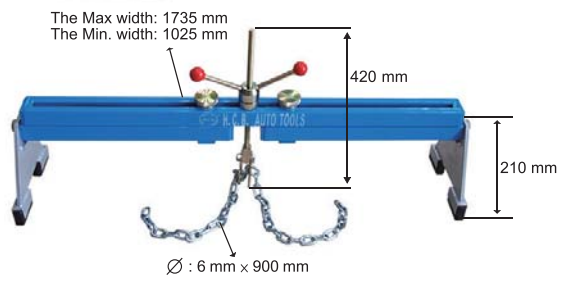

PICTURE 1



PICTURE 2



- There are two ways to hold the chain with a hook into a loop. Please see picture 1 and 2. Put a hook and slide it onto a loop of the chain. Check it to see if the loop is securely held by the hook.
- The width from Min to Max is 1025 mm to 1735 mm, saving space for storage. It is applicable to all kinds of engines.
- N.W.: 14KGS
- The following are the common features for above-mentioned three tools:
 - 1.Straddling the inner fender walls and acting as a bridge to support engines.
 - 2.Adjustable in height and width to bridge various vehicle fender walls and securely hold engine in place.
 - 3.Including slider bolt that can be positioned anywhere on the bar for the best weight distribution.

H.C.B-D2016 DOUBLE HOOKS ENGINE STABILIZER BAR

雙勾引擎平衡桿

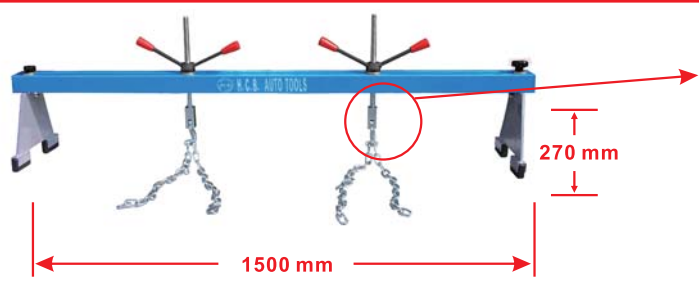

H.C.B-E2016 VW SEDAN ENGINE STABILIZER BAR

VW 轎車引擎平衡桿

1 / 18.5 / 19.5 / 2.38'

- Application: All VW sedans. The supporting plates slanted 10° to fit the angle of VW sedans.
- Capacity : 1000 LBS.

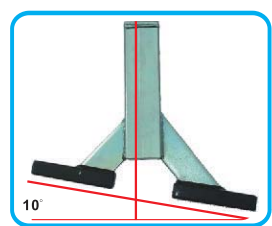
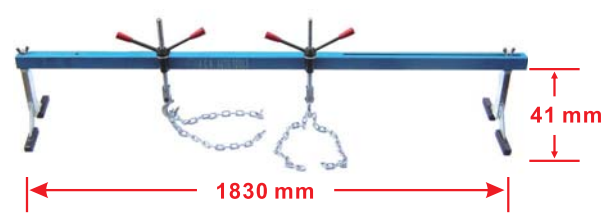



H.C.B-F2016

UNIVERSAL ENGINE STABILIZER BAR (TRI-BRANCHES)

萬用引擎平衡桿 (三叉式)

1 / 23 / 24 / 2.38'

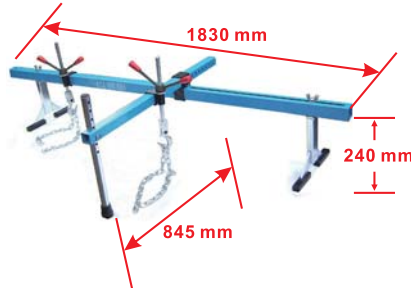

- The main body is made from 50 mm square tube in 1830 mm length. Two removable supporting plates with rubber pad can prevent body of car from scraped.
- The adjustable 40 mm square tube in 845 mm length offers the third support to avoid the engine toppling down. It is a special design with safe and convenience.
- Two forged hooks and chains make it easy to hang on all kinds of engine.
- Application: all vehicles.
- 50 mm方形管、長1830 mm，搭配兩只可移動式、包覆橡膠的腳墊，可防止刮傷車身。
- 40 mm方形管、長845 mm，提供第三點支撐可防止引擎傾倒。安全又便利的特殊設計。
- 鍛造吊勾搭配吊鍊，方便吊掛各式引擎。
- 適用：各式車種。

H.C.B-G2016

VW T4 ENGINE STABILIZER BAR

VW T4 引擎平衡桿

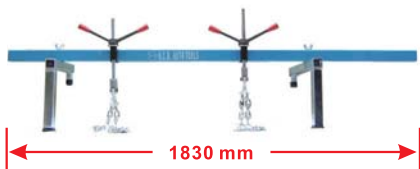

■ Applicable: VW T4.

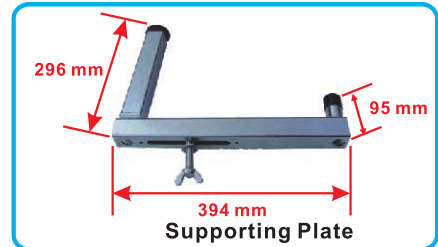

H.C.B-H2016

ENGINE LIFTING BAR (IMPROVEMENT)

引擎平衡桿 (完美改良型)

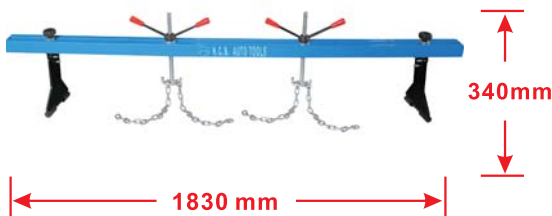

- With extended fix base and adjustable supporting seat, it can be used on most of cars. With round rubber pad it can stand steadily.
- With two hooks and two chains, it is good for securely hoisting all kinds of engines and transmission.
- Specification: W 1830 mm x D 210 mm x H 340 mm.
- 改良版的加長基地座，可旋轉角度，幾乎各種車種使用。底座有橡膠墊支撐，不會損壞車子，且更牢固。
- 兩條鉤子與鏈條的搭配，可將引擎及變速箱更確實地平衡固定。

H.C.B-B1167 TOYOTA DIESEL FUEL WRENCH SOCKET (FLUID RESERVOIR ON CONDENSER) (17 mm)

TOYOTA 柴油冷凝器貯油槽套筒扳手 (17 mm)



H.C.B-A1223 TOYOTA ALTIS SPECIAL 6-POINT SOCKET (Dr. 1/2", 10 S)

TOYOTA ALTIS 特殊套筒 (Dr. 1/2", 10 S)

- For removing and replacing the retaining screws on idler pulley of TOYOTA 1ZZ-FE engine
- Size: (1/2"x10S)



Drive	Size	Length (mm)	Weight (g)
1/2"	10S	32	46

H.C.B-B1223 NISSAN SPECIAL 6-POINT-STAR IMPACT SOCKET (Dr. 1/2", M12S)

NISSAN 特殊套筒 (Dr. 1/2", M12S)

- To remove and replace the bolt on head gasket.
- Size: Dr. 1/2" x M12S x 38 mm
- Engine tool for NISSAN.

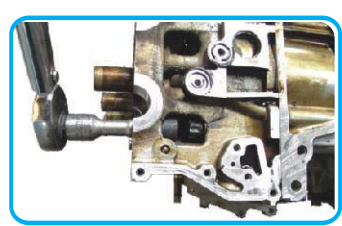

Drive	Size	Length (mm)	Weight (g)
1/2"	12S	38	72

H.C.B-C1223 NISSAN SPECIAL 6-POINT-STAR IMPACT SOCKET (Dr. 1/2", 8 S)

NISSAN 特殊套筒 (Dr. 1/2", 8 S)

- Engine tool for NISSAN.

Drive	Size	Length (mm)	Weight (g)
1/2"	8S	38	50





H.C.B-D1223

SPECIAL 6-POINT SOCKET (Dr. 1/2", 6 S)

特殊套筒 (Dr. 1/2", 6 S)

Drive	Size	Length (mm)	Weight (g)
1/2"	6S	38	47

- Application: Volvo S40 variable valve pulley nut.



H.C.B-E1223

NISSAN SPECIAL 3-POINT-STAR IMPACT SOCKET (Dr. 1/2", 8 TS)

NISSAN 特殊套筒 (Dr. 1/2", 8 TS)

Drive	Size	Length (mm)	Weight (g)
1/2"	8TS	38	45



H.C.B-A1098

HAND HOLDING VALVE SPRING COMPRESSOR

握把式汽門彈簧壓縮組

- For both the removal and assembly of valve springs where only hand pressure is required.
- Ideal for the replacement of valve stem seals without removing the cylinder head.
- Used when the valves on No.1 cylinder are to be used for setting piston height for valve timing.
- This useful tool is supplied with 2 adapters: 25 mm and 30 mm.



H.C.B-A2116

VALVE SPRING COMPRESSOR KIT

免拆式凡爾鉗

5 / 17.7 / 18.7 / 2'

- This is a kit with everything you need to remove & install the valve spring with the cylinder head on or off the OHV & OHC petrol or diesel engines.
- An ideal tools kit for most of engines.
- The multi-point adjustable base of this tool bolted securely to the head while the adjustable lever mechanism pivots from the beam. Thus, compressing the spring quickly by one hand operation.
- Fast removal & installation of the spring retaining keeper. Can be easily accomplished through the large open on both sides of the compressing tube.
- On car maintenance.



H.C.B-B1376

**UNIVERSAL VALVE SPRING REMOVER/INSTALLER (22 PCS)
PAT.M411316 & M409923 DE PAT.**

多功能免拆式汽門彈簧拆裝工具組 (22 PCS)

- Replace valve spring and oil seal of valve rod on car, without removing head gasket.
- Work great in the narrow engine room.
- Save enormous time from the replacement of valve stem seals.
- Special design helps compress valve spring regardless of firewall barrier.
- Apply for European, and Japanese cars. Such as BENZ, VOLVO, TOYOTA TERCEL, MITSUBISHI SAVRIN, VW, FORD etc.
- Especially suitable on BENZ V6 Engine and BMW V8 Engine.
- Application:
BENZ M102, M103, M104, M111, M112, M113, M271, M272.
BMW N42, N52, N62, M52, M54, M56, M60.
- Gain Germany and Taiwan patent.
A1376 has adapters application in universal cars.
B1376 has additional five adapters for BMW N42/N52/N54/E65/E66 and BMNZ M102/M103/M272/M273



B1376-18	BMW N52、N54, Mercedes Benz M272, M273
B1376-19	BMW N52、N54, Mercedes Benz M272、M273
B1376-20	For BMW E65/E66 BMW N52、N54, Mercedes Benz M272、M273
B1376-21	For BMW N42
B1376-22	For BENZ M102/M103

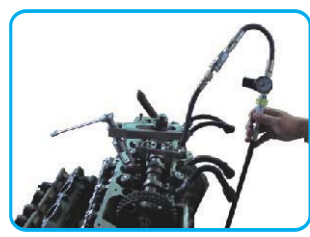
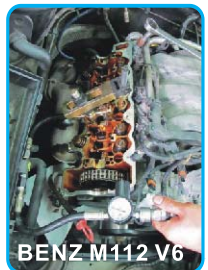

B1376-20
D:24
d:21
L:53.5mm



B1376-21
D:20
d:17
L:53.5mm



B1376-18 M12 x P1.25 xL 330mm



B1376-19 M7 x P1.0 x L70mm

B1376-22 M8

+ Optional (選購)



B1376-23 can use on N63(X6 4400 cc.)

H.C.B-A1376

**UNIVERSAL VALVE SPRING REMOVER/INSTALLER
PAT. M411316 & M409923 DE PAT.**

多功能免拆式汽門彈簧拆裝工具組

- Applicable engine model:
Benz M102, M103, M104, M111, M112, M113, M271, M272.
BMW N42, N52, N62, M52, M54, M56
TOYOTA-Tercel, FORD, MITSUBISHI SAVRIN, VW, AUDI





H.C.B-A2156 VALVE SPRING COMPRESSOR

萬能凡爾鉗

- Reversible jaw adaptor for multi-valve engines.
- Capacity 45-145 mm, throated clearance 250 mm big window jaw adaptor for easy replacement of valve collects.
- Dual size in 25 mm and 30 mm diameter.



H.C.B-A2223 VALVE OIL SEAL REMOVER/ INSTALLER KIT

汽門油封拆裝組

10 / 18 / 19 / 2.1'

- Work on both valves still seated or removed.
- To guide and set the seal by seal driving adapters.
- Specification:
 - A. deep seal driving sockets for seals O.D. 10.8-14.8 mm (2 pcs)
 - B. seal driving adapters: fit seals 5, 5.5, 6, 6.6, 7, 8 & 3/8" mm (7 pcs)
 - C. valve stem seal pliers (1 pcs)
 - D. drive handle 6" (150 mm) long (1 pcs)



H.C.B-A1193 CADILLAC NORTHSTAR/OLDSMOBILE AURORA WATER PUMP R&R SOCKET (4600 c.c.) (Dr. 1/2", 6 TEETH)

凱迪拉克 NORTHSTAR/OLDSMOBILE AURORA 水幫浦拆裝套筒(4600 c.c.) (Dr. 1/2", 6 齒)

- This unique socket is used for removing and installing the water pump on Cadillac Northstar 4.6 Liter V-8 engines 1993 and later Oldsmobile Aurora 4.0 Liter V-8 engines 1997 and later.



H.C.B-A1142 GAS REVOLUTION HOLDER BAT

油門轉速固定器

- This tool is designed to help the technicians to hold a stable RPM for functional check or troubleshooting on the engines.
- Application: all kinds of vehicles, sedan, RV, SUV, turcks...etc.
- Mount one end of holder bat on gas paddle,another end at the steering wheel.

Note: Adjustable nut should face upward.

- Adjust the nut clock-wise to increase the RPM (extend holder bat) required,otherwise counter clock-wise revolution will reduce the RPM.
- Combine the tool with chemicals to clean the engines.



H.C.B-B2026

HEAVY DUTY SPARK PLUG FIRING TESTER

調整式火花測試器

- To judge the quality of coil according to spark color and distance.
- The car factory choose the appropriate coil depends on engine and ignition system.
- Application:

The normal spark distance is 2 cm, and the shape is straight with violet blue color. The coil is aged or defect if the spark is either red or curved. Spark plug in oil vapor that spark ignition cylinder, and also in combustion chamber with pressuring. Higher pressure would cause larger impedance of spark plug. In order to apply many kind of compression ratio of engine, adjust the distance of spark tester to simulate the state of cylinder is burning.



H.C.B-A2033

STRAIGHT EDGE

汽缸平面量規壓尺

- Great stability with 5/8" width, 1-3/8" height and 20-1/2" length.
- Convenient hanging hole and edge protector.
- Use feeler gauges to check for distortion in engine blocks, cylinder head and flywheels.
- G.W:2.4 KGS
- Material: S50C
- Hardness: HRC 43°~48°
- Parallel accuracy: ±3°
- L x W x H: 600 x 16 x 36 mm
- Check for warpage across the head surface with the headclean and dry.
- Use a precision straight-edge and a feeler gauge to measure the head for warpage.
- If it is less than 0.002" (0.05 mm), resurfacing is not required. If warpage is between 0.002-0.008" (0.05-0.2 mm), the head must be resurfaced. The standard is 95 mm (3.66"). The max surfacing clearance is 0.008" (0.2 mm).



H.C B-A2027

SEAL PULLER

油封拉拔器 (雙頭大型)

- Remove oil & grease seals.
- Two tips fit most application.
- N.W.: 0.36 KGS



H.C.B-A1166

HYUNDAI TRAJET (DIESEL ENGINE) OIL FILTER WRENCH (Dr. 1/2", 15 POINTS, 82 mm)

HYUNDAI TRAJET (柴油休旅車) 機油芯拆裝器 (Dr. 1/2", 15 角, 82 mm)

- Dr.1/2", 5 POINTS, 82 mm
- Application: HYUNDAI TRAJET (diesel engine)

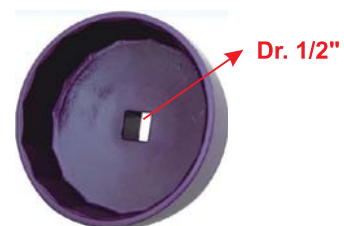



H.C.B-A2018-4

MITSUBISHI OIL FILTER WRENCH (Dr. 1/2", 14 POINTS, 66 mm)

三菱機油芯扳手 (Dr. 1/2", 14 角, 66 mm)

30 / 8.1 / 10 / 1.49'

- Size: 14 points, 66 mm
- Application: LANCER 1.6T & VIRAGE 1.8T
- Genuine NO.: MD349105

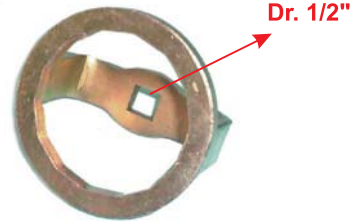

H.C.B-A2018-6

VW OIL FILTER WRENCH (Dr. 1/2", 9 RIBS, 95 mm)

VW 機油芯扳手 (Dr. 1/2", 9 齒, 95 mm)

- N.W.: 0.394 KGS



BOSCH 0 451 203 087
T4 2400C.C. Diesel,
2500C.C. Gasoline



Audi 078 115 561 J
Audi A4 (2800C.C.),
Audi A6 (3000C.C.),
VW Passa (2800C.C.)

H.C.B-A2018-7

RENAULT OIL FILTER WRENCH (Dr. 1/2", 6 RIBS, 66 mm)

雷諾機油芯扳手 (Dr. 1/2", 6 齒, 66 mm)

- Size: 66 mm
- N.W.: 0.202 KGS



H.C.B-A2018-8

NISSAN OIL FILTER WRENCH (15 POINTS, 80 mm)

NISSAN 機油芯扳手 (15 角, 80 mm)

- N.W.: 0.292 KGS



H.C.B-A2018-9 NISSAN OIL FILTER WRENCH (15208 53J00) (14 POINTS, 64 mm)

NISSAN 機油芯扳手 (15208 53J00) (14 角, 64 mm)

- Size: 14 points, 66 mm
- Genuine no.: 15208 53J00
- N.W. : 0.248 KGS



H.C.B-A2018-10 NISSAN OIL FILTER WRENCH (15208-31U01 MD136466) (14 POINTS, 63mm)

NISSAN 機油芯扳手 (15208-31U01 MD136466) (14 角, 63 mm)

- Genuine No. : 15208-31U01 MD136466
- N.W. : 0.294 KGS



H.C.B-A2018-15 MITSUBISHI SAVRIN (2000 c.c.) OIL FILTER WRENCH (15 POINTS, 79 mm)

三菱 SAVRIN (2000 c.c.) 機油芯扳手 (15 角, 79 mm)

- Genuine No.: MD136466
- Application:
Mitsubishi SRV – Savrin 2.0 L (Oil filter OEM No. ref.: MD136466),
Subaru WRX 2.0 (2015 - 2016) (Oil filter OEM No, ref.: 15208AA170),
Subaru WRX STI (2015-2016) (Oil filter OEM No, ref.: 15208AA170).



H.C.B-A2018-16 SUZUKI SWIFT OIL FILTER WRENCH (Dr. 1/2" ,14 POINTS, 65 mm)

SUZUKI SWIFT 機油芯扳手 (Dr. 1/2",14 角, 65 mm)

- Oil Filter No. : 16510-61A01-T
- Application: SUZUKI SWIFT



H.C.B-A1272 TOYOTA LEXUS OIL FILTER WRENCH (Dr. 3/8" , 14 POINTS, 64 mm)

TOYOTA LEXUS 機油芯扳手 (Dr. 3/8", 14 角, 64 mm)

- Dimensions: Dr. 3/8", 14 Points, 64mm
- Application:
Fits 2007–2008 Toyota 3.5L V6
Lexus Models:
GS 300 (2006), IS 250 (2006-), IS 350 (2006-), ES 350 (2007-), GS 350 (2007-),
GS 450h (2007-), LS 460 (2007-), RX 350 (2007-) and LS 600h L (2008).
- Size: Dr. 3/8", 14 Points, 64 mm

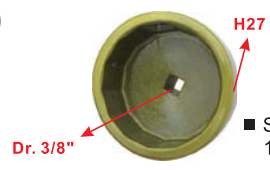

■ Caution: Please use 27 mm socket with a wrench to manipulate this tool when the torque is over 25 Nm, otherwise this tool will risk being broken. The torque value limit is 25 Nm if this tool is operated with a wrench.



H.C.B-B1272

TOYOTA LEXUS OIL FILTER WRENCH (Dr. 1/2", 14 POINTS, 64 mm)

TOYOTA LEXUS 機油芯扳手 (Dr. 1/2", 14 角, 64 mm)

- Application: Fits 2007–2008 Toyota 3.5L V6
Lexus Models: GS 300 (2006), IS 250 (2006-), IS 350 (2006-), ES 350 (2007-), GS 350 (2007-), GS 450h (2007-), LS 460 (2007-), RX 350 (2007-) and LS 600h L (2008).
Allion, Auris, Corolla axio, Corolla fielder, Corolla rumion, Isis, Ist, Noah, Premio, Prius, Voxy, Wish



Size: Dr. 1/2", 14 Points, 64 mm



H.C.B-B1370

TOYOTA OIL FILTER WRENCH (Dr. 3/8", 14 POINTS, 64.5 mm)

TOYOTA 機油芯扳手 (Dr. 3/8", 14 角, 64.5 mm)

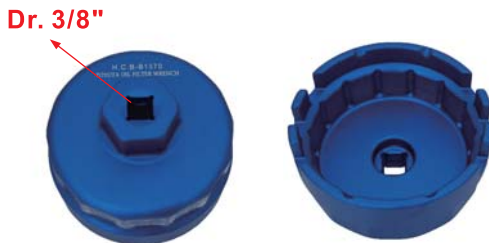

- Size: Dr. 3/8" x H24, 14 POINTS, 64.5 mm
- Combined with a 24 mm or 15/16" socket.
- Application: Allion, Auris, Corolla axio, Corolla fielder, Corolla rumion, Isis, Ist, Noah, Premio, Prius, Voxy, Wish



- Caution: Please use 27 mm socket with a wrench to manipulate the tool when the torque is over 25 Nm, otherwise the tool will risk being broken.
- The force of torque is under 25 Nm if the tool is operated with a wrench.

H.C.B-A1639

NEW

TOYOTA/LEXUS FUEL TANK LID WRENCH (Dr. 1/2", 24 POINTS)

TOYOTA/LEXUS 汽油浮筒拆裝器 (Dr. 1/2", 24 POINTS)



- Toyota fuel pump gauge retainer: 77169-52040, 77144-04010, 77144-52040
- Lexus fuel pump gauge retainer: 77144-48020
- Application:
 - Corolla: 2004-2014; CE, ECO, ECOSW, LE, S, STD, XR, XRS; 4-Cyl 1.8 L, 4-Cyl 2.4 L
 - Land Cruiser: 2008-2015; 8-Cyl 5.7 L
 - Matrix: 2004-2014; CE, LE, S, STD, XR, XRS; 4-Cyl 1.8 L, 4-Cyl 2.4 L
 - Tacoma: 2005-2014; 4-Cyl 2.7 L, 6-Cyl 4.0 L
 - Yaris S, Yaris Base: 2007-2011; 4-Cyl 1.5 L
 - Vios: After 2014
 - Lexus: RX330 2004-2006; 6-Cyl 3.3 L, 6-Cyl 3.5 L
RX350 2007-2014; 6-Cyl 3.3 L, 6-Cyl 3.5 L
RX450h 2010-2014; 6-Cyl 3.5 L



010
HWANG CHERNG BIN
Specialty Tools Inc.

一般修護工具 引擎
General Engine Repair Tool

General Engine

H.C.B-A2220 FILTER SOCKET MASTER KIT (7 PCS)

機油芯扳手組 (7 PCS)



Item No.	Size	Suitable
A2220-A	24mm	Cadillac 36
A2220-B	27mm	Benz A Class, VW, 2.8L, 3.2L & 3.6L V6 Cadillac CTS, STS and SRX Buick Rendezvous Ultra, Lacrosse CXS and Saturn L3000, SAAB 9-5 & Benz 1.8L
A2220-C	29mm	Dodge Cummins Fuel Filter Housing
A2220-D	32mm	2.2 Saturn Ecotec, SAAB and GM
A2220-E	35/36mm	Ford 6.0L Diesel Fuel and Oil Filter Housings, Mini Cooper and Some BMW Oil Filter Housings and Mack Truck Oil Filter Housing /VWT5
A2220-F	38mm	Vauxhall / Vectra 2 Liter Diesel Engine
A2220-G	30mm	Korean Car



H.C.B-A2218 TOYOTA/ NISSAN OIL TUBE REMOVER

TOYOTA/ NISSAN 汽油管拆卸器

- Application: Toyota, Nissan injector tube



H.C.B-A2172 MITSUBISHI BELT TENSION ADJUSTER

三菱惰輪皮帶張力調整器

- Two cylinder design helps fix the tension pulley easily by the 1/4" wrench.
- Application : MITSUBISHI model with injection engine.

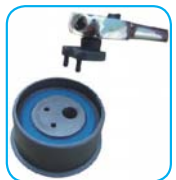

H.C.B-A2058 UNIVERSAL HOSE CLAMP REMOVER

可彎式喉式管束夾鉗

48 / 22 / 23 / 1.9'

- For replacement of fuel, oil and water hose.
- Convenient for working in hidden areas and long distance.



H.C.B-B2058 UNIVERSAL HOSE CLAMP REMOVER

可彎式喉式管束夾鉗

- This tool is able to reach the working place where bare hands or other pliers are untouchable.
- Universal use on all kinds of clamps. Easy to use.
- Hose clamp with flexible 600 mm wire.





H.C.B-C2058

UNIVERSAL HOSE CLAMP REMOVER (EXTENDED)

可彎式喉式管束夾鉗 (加大型)

- For replacing the hose of fuel, oil and water.
- Application: BENZ, VW Passat Diesel.



H.C.B-D2058

ROPE HOSE CLIP PLIERS

鋼索式管鉗

- For replacement of fuel, oil and water hose.
- Hose clamp with flexible 600 mm wire.
- Convenient for working hidden areas and long distance.



H.C.B-A1365

PEUGEOT (207, 308, 3008 1.6/HDI) BELT IDLER ADJUSTER

PEUGEOT (207, 308, 3008 1.6/HDI) 皮帶惰輪調整扳手

- To adjust the belt idler.
- Application: Peugeot 207, 308, 3008 1.6/HDI



H.C.B-A2042

UNIQUE COMPRESSION TESTER KIT

汽缸壓力錶 (膜片式)

24 / 20.8 / 22 / 1.63'

- Test compression on all cars and trucks with gasoline engines.
- Long flex NBR hose and adapters allow the compression test without removing engine accessories.
- 2-1/2" gauge-300 PSI and 0-21 KG
- Adapters included:
 - 1.Extension 14 mm thread head
 - 2.Extension aluminum tube
- NBR hose with 10 mm & 12 mm and 14 mm & 18 mm in two separate thread head.

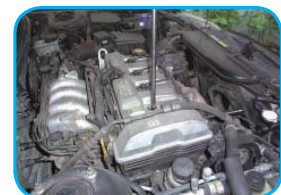
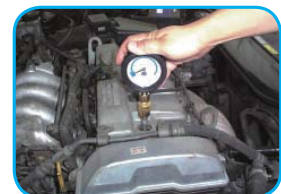

H.C.B-A2054

GASOLINE ENGINE INJECTING PRESSURE TESTER KIT

汽油燃油壓力試驗器 (全車種)

5 / 21.2 / 22 / 4.91'



The uniquely designed relief valve



The gauge can be held easily with the attach



The quick coupling system

- This tester is for fuel injection pressure test with complete instruction manual.
- Application: American, Japanese and European cars.
- Easy to use and save time.
- Accurate, best choice for troubleshooting
- Specification:
 1. Large 3 inch gauge with dual readings of 0 PSI and 0 KPA to 800 KPA.
 2. A quick coupling designs: Adapters, gauges, and hose assemblies feature a quick Coupling system for speedy and efficient testing connection
 3. The uniquely designed relief valve relieves the pressure and the fuel safely.
 4. Easy to check fuel flow.
 5. No need for wrenches or hand tools.
 6. The special designed compact, neatly arranged plastic blow-molded case makes storage easy.



H.C.B-A2063

COMPRESSION TESTER KIT

改良型汽缸壓力錶

10 / 12.5 / 13.5 / 1.26'

- Air gauge with quick coupling & releasing valve.
- High-tension connecting pipe with safety lock coupling.
- Crank shaft type test pipe with rubber.
- Transverse axis test pipe with rubber plug.
 10. M10 x 1.0 adapter
 12. M12 x 1.25 adapter
 14. M14 x 1.25 adapter
 18. M18 x 1.5 adapter



H.C.B-A2225

DIESEL ENGINE COMPRESSION TESTER KIT

柴油汽缸壓力錶

- Comprehensive test kit for both direct and indirect diesel injection cars.
- Simple & easy to use.
- Check engine compression under cranking conditions.
- Small profile, quick coupling adapters for speed & security.
- Built-in pressure relief valve enables repeat tests without dismantling.
- Flexible hose (355 mm) gives access to restricted plug & injector ports.
- Dual scale 80 mm dia gauge 0-1000 lb/in² & 0-70 Bar.
- Application: BMW, BENZ, CARBODIES, CITROEN, DACIA, DIAHATSU, FIAT, FORD, HOLDEN, ISUZU, LAND ROVER, LEYLAND / DAF, MAZDA, MITSUBISHI, NISSAN, OPEL, PEUGEOT, RENAULT, ROVER, SEAT, TOYOTA, VAUXHALL, VOLKSWAGEN, VOLVO



Glowplug Adapter:

A2225-B	M10 x P1.25 x 73.5mm/L
A2225-C	M12 x P1.25 x 54mm/L
A2225-D	M14 x P1.25 x 72mm/L
A2225-H	M10 x P1.25 x 114.5mm/L
A2225-I	M10 x P1.0 x 119mm/L

Injector Adapter:

A2225-J	M20 x P1.5 x 78mm/L
A2225-F	M24 x P2.0 x 64mm/L
A2225-G	STANADYNE, ϕ 19mm, 112mm/L
A2225-E	DL, ϕ 21mm, 114mm/L

Clamp Plate: ϕ 17 mm (Hole), 63.5 mm/L, 25 mm/W





H.C.B-A2065 ENGINE OIL PRESSURE TESTER

機油壓力測試錶

10 / 13 / 14 / 3.02'

- Dial diameter: 2-1/2"
- Pressure range: 0-300 psi/0-21 KG/cm²
- Housing: black-painted steel
- Ring: chrome-painted steel
- Lens: acrylic
- Pointer: flat black-painted aluminum
- Rubber protector
- 6 ft (1.8 m) of oil proof hose with 1/8" PT.
- Also including 9 pieces adaptors.



H.C.B-A2143 COOLING SYSTEM TESTERS (7 PCS)

水箱壓力錶組 (快速型) (7 PCS)

10 / 22.3 / 23.5 / 4.6'

- To test water tank and density of water tank cover.
- Application: Mercedes, GM (Buick), Jeep, Peugeot Subaru, Chrysler, Acura, GM (Nova, Spectrum, Sprint) Nissan, Mazda, Toyota, Mitsubishi, Infiniti, Geo, Suzuki, Isuzu, Ford, Honda, Mitsubishi

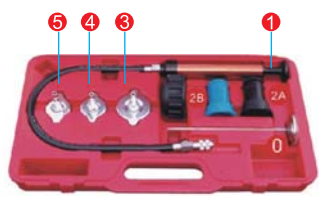

H.C.B-A2096 UNIVERSAL RADIATOR PRESSURE TESTER KIT

簡易式水箱測試組

5 / 12.5 / 13.5 / 2.64'

- This tester kit is used for checking the radiator to see if any water leaked because the body or the connector is not fitted properly or any broken. It is tested through pressure increase by using an adapter for closing the master or second inlet of the radiator then pushing the manual pump by hand.

■ **Contents:**

- # 0: Needle Thermometer
- # 1: Manual pump with quick joint & release valve
- # 2: Universal adapter with 3 rubber rings (used for cars not listed on Nos. 3-5) (See Fig.1,2,3)
- # 3: Japanese R123 adapter- suitable for Benz, GM(Buick) & Jeep
- # 4: Japanese R134 adapter- suitable for Peugeot, Subaru, Chrysler, Acura, GM(Nova, Spectrum & Sprint), Mitsubishi, Nissan, Mazda, Toyota, Infiniti, Geo, Suzuki, Isuze & Ford
- # 5: Japanese R125 adapter- suitable for Honda, Toyota, Suzuki, Mitsubishi, Chrysler & Acura

■ **Operation:**

1. According to the type of car, choose a suitable adapter and screw it in the inlet of radiator then have the manual pump pressure increased to 15-20PSI and stay the level 5-10 minutes for checking. If the pressure in the meter lower automatically, then check the body of radiator or the connector joint to see if any leaked. If the pressure is kept same, then the radiator is in good condition.
2. Before using No. 2 universal adapter, be sure to clear up the inlet of the radiator then check its size and chose an appropriate rubber ring to fit then screw securely to the inlet of the radiator. Before loosening the adapter and the manual pump, be sure to leak out the pressure to prevent the water coming out from the radiator.

■ **Warning:**

1. While the water in the radiator stay in high temperature, please do not open the lid of radiator to prevent hot water come out.
2. While No. 2 universal adapter is used, the pressure in the manual pump must be not above 15-16PSI to prevent the adapter shut off because of high pressure.
3. While testing, if the pressure in the meter go lower but no water is leaked, then be sure to check the adapter if any not closed securely or the pump is broken.

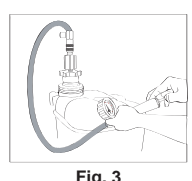
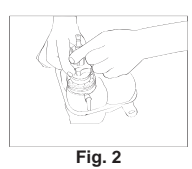

H.C.B-A2066

VACUUM & FUEL PUMP PRESSURE TESTER

引擎真空與燃油壓力測試錶

24 / 19 / 19.5 / 2.45'

- Dial diameter: 3-1/2"
- Pressure range: 0-15 psi / 0-1 kg / cm² & 0-30 inhg / 0-76 cmhg.
- Housing: black-painted steel.
- Ring: black-painted steel.
- Lens: glass.
- Pointer: flat white-painted aluminum.
- Rubber protector.
- 6.5 mm brass fittings.
- 950 mm nbr hose with taper vacuum fitting.
- 3 pcs adaptors.



H.C.B-A2067

AUTOMATIC TRANSMISSION & ENGINE OIL PRESSURE TESTER

引擎機油測壓錶

14 / 114.3 / 15.8 / 2.39'

- Dual gauges
- Dial diameter: 2-1/2"
- Pressure range: A: 0~400 psi / 0~28 bar
B: 0~100 psi / 0~7 bar
- Housing: black-painted steel
- Ring: chrome-painted steel
- Lens: acrylic
- Pointer: flat black-painted aluminum
- Rubber protector
- 6 ft (1.8 m) oilproof hose with super speed adaptor
- Including 9 piece of adaptors



H.C.B-A2149

EXHAUST BACK PRESSURE GAUGE

排氣背壓錶組

10 / 21.2 / 23 / 2.3'

- To prevent engine from being unsteady in idleness, accelerate incapable and over oil consumption. This kit can detect exhaust back pressure and test the effective of catalytic converter.
- Accessory:
 - (1) One piece of Main body and PTFE hose (High temperature resistance: over 280°C)
 - (2) One piece of universal copper joint.
 - (3) One piece of joint, special for TOYOTA and MITSUBISHI (connect with joint No. 2).





H.C.B-A2150

UNIVERSAL RADIATOR PRESSURE TESTER KIT (NYLON 66) (18 PCS)

萬用水箱壓力測試組 (尼龍 66) (18 PCS)

4 / 14.5 / 15.5 / 2.93'

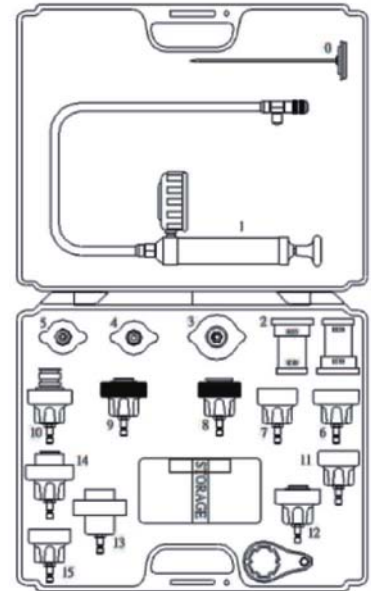

■ Specification

- 0: Temperature
- 1: Pressure Testing Pump with Gauge
- 2A: Connector R123/R124 (Black color)
- 2B: Connector R123/R125 (Blue color)
- 3: BENZ, GM(BUICK), JEEP
- 4: PEUGEOT, SUBARU, CHRYSLER, ACURA, GM(NOVA, SPECTRUM, SPRINT) , KIA, MITSUBISHI, NISSAN, MAZDA, TOYOTA, INFINITI, GEO, SUZUKI, ISUZU, FORD
- 5: HONDA, TOYOTA, SUZUKI, MITSUBISHI, CHRYSLER, ACURA
- 6: BENZ(ML-CLASS), GM(ACHIVA, SKYLARK, GRAMD AM-1992~2002)
- 7: VOLVO, SAAB, STERLING, CITROEN, RENAULT, FIAT, ALFA, JEEP
- 8: VW(VENTO, T4, PASSA-1996, GOLF, BEETLE, SHARAN)
- 9: AUDI(A4 · A5 · A6) , BMW345, VW (PASSA-1997~2002), PORSCHE(CAYENNE)
- 10: BMW
- 11: AUDI, VW
- 12: FORD, INTERNATIONAL, SSANG YONG MOTOR, LAND ROVER, OPEL, JAGUAR, MERCEDES-BENZ
- 13: MERCEDES-BENZ (C-CLASS, E-CLASS, S-CLASS)
- 14 : FORD
- 15 : MAZDA(M3)
- H : HAND



H.C.B.-C2210 RADIATOR PRESSURE TESTER & VACUUM-TYPE COOLING SYSTEM KIT (NYLON 66) (28 PCS)

萬用水箱壓力測試組 (尼龍 66) (28 PCS)

- For cooling system pressure test and refilling new coolant by creating vacuum in the cooling system.
- A comprehensive cooling system pressure testing kit for universal use.
- Suitable for large of vehicles.



No.		No.		No.		No.					
0	Thermometer	4	Kia	6	Cadillac	8	VW	16	Mercedes Benz		
1	Pressure Testing		Lexus		Daewoo		9	Audi	17	BMW	
2A	Connector R123/		Mazda		Ford	BMW		Porsche	18	VW	
2B	Connector R123/		Mercury		GM		Jaguar	VW	19	Toyota	
3	Buick	5	Mitsubishi	7	Jeep	10	BMW	20	Saab		
	Chrysler		Mercedes Benz		Land Rover		11	Audi	21	Ford	
	Chevrolet		Nissan		Mercedes Benz			VW		Hummer	GMC
	Dodge		Subaru		Mercury						Audi
	Jeep		Suzuki		Pontiac	Porsche	VW	Lincoln			
	Mercedes Benz		Peugeot		Saab			Saab		Ssangyong moto	Mazda
	Oldsmobile		Toyota		Saturn	Ford	International				Mercury
Pontiac			Land Rover	Opel	Oldsmobile						
4	Acura	5	Acura	7	Alfa Romeo	12	Land Rover	Opel	Pontiac		
	Chevrolet		Chevrolet		Citroen		Opel	Saab	Opel	Saab	
	Chrysler		Dodge		Fiat				Ssangyong moto	Chrysler	Saturn
	Dodge		Eagle		Mini Cooper						Mercedes Benz
	Eagle		Geo		Peugeot	Renault	Ford		22	BMW	
	Ford		Honda		Saab			Sterling			Ford
	Geo		Isuzu		Jeep	Volvo	Mazda				
	GM		Lexus								
	Honda		Mercedes Benz								
	Hyundai		Mitsubishi								
Infiniti	Suzuki										
Isuzu	Toyota										



H.C.B-A2113 LEAK-CHECK FOR COMBUSTION

引擎燃燒室測漏組 (藥水型)

10 / 12.5 / 13.5 / 3.13'

- Spot and locate combustion leaks quickly in cracked or warped heads, leaky gaskets or cracked block. Use leak-check in the radiator opening with engine idling. The blue test liquid will turn into yellow to green in 60 seconds if there is a combustion leak, no matter how small. Get exact location of leak by disconnecting one spark plug at a time and retest. Complete to proof of leak.
- Perfect combination with H.C.B-A2008.



H.C.B-B2113 LEAK-CHECK FOR COMBUSTION WITH 3PCS RADIATOR CAP

引擎燃燒室測漏組 (藥水型) 附 3 PCS 水箱蓋

10 / 13.5 / 14.5 / 3.05'

- Spot and locate combustion leaks quickly in cracked or warped heads, leaky gaskets or cracked block. Use leak-check in the radiator opening with engine idling. The blue test liquid will turn into yellow to green in 60 seconds if there is a combustion leak, no matter how small. Get exact location of leak by disconnecting one spark plug at a time and retest. Complete to proof of leak.

Application:

- #6 radiator cap: BENZ (W123/W126/W124/W201), GM (Buick), Jeep.
- #7 radiator cap: Peugeot, Subaru, Chrysler, Acura, GM (Nova, Spectrum, Sprint), Mitsubishi, Nissan, Mazda, Toyota, Infiniti, GEO, Suzuki, Isuzu, Benz.
- #8 radiator cap: Honda, Toyota, Suzuki, Mitsubishi, Chrysler, Acura



H.C.B-A2089 1/2" M9 CYLINDER HEAD BOLT TOOL (100 mm)

1/2" 12 角軸套筒 (100 mm) (M9)

- The 100 mm length allows easy access the recessed head bolts.
- Come with Dr. 1/2" for use with a torque wrench.
- Use for TOYOTA TERCEL cylinder head bolt.



ITEM No.	Size
A2089-M6	M6
A2089-M8	M8
A2089-M9	M9
A2089-M12	M12
A2089-M14	M14
A2089-M16	M16

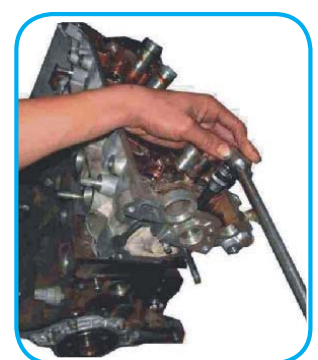



010
HWANG CHERNG BIN
 Specialty Tools Inc.

一般修護工具 引擎
 General Engine Repair Tool

General Engine



H.C.B-B2089

6 PCS TRIPLE SQUARE DRIVE KIT (M6, M8, M10, M12, M14, M16)
 (Dr. 1/2" x 140 mm)

6 PCS 星形套筒組 (Dr. 1/2" x 140 mm)

- The 140 length allows easy access the recessed head bolts.
- Come with Dr.1/2" for combining with a torque wrench.
- The same function as H.C.B-A2089

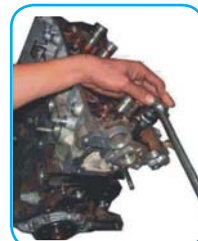

H.C.B-A2097

DEEP TWIST SOCKET KIT (Dr. 1/2")

螺旋拆裝器 (Dr. 1/2")

- Used on the damaged screws & nuts. Special spiral design for easier removal of the damaged screws.
- The deep design for easier use on the tire screws.
- Size:Dr. 1/2"17, 19, 21, 22 mm Length: 50 mm



H.C.B-A2090

1/2" x M10S CYLINDER HEAD BOLT TOOL (100 mm)

1/2" X M10S 12 角軸套筒 (100 mm)

- 100 mm long tool is to access the recessed head bolts.
- Dr. 1/2" drive for combining with a torque wrench.
- Application: VW, AUDI cylinder head bolts.
- The same function as H.C.B-A2089.



H.C.B-B2090

1/2" x M10S CYLINDER HEAD BOLT TOOL (100 mm)

1/2" X M10S 12 角軸套筒 (100 mm)

- 100 mm long tool is to access the recessed head bolts.
- Dr. 1/2" drive for combining with a torque wrench.
- Application: VW, AUDI cylinder head bolts.

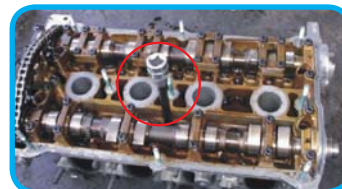

H.C.B-C2090

1/2" x M10S CYLINDER HEAD BOLT TOOL (140 mm)

1/2" X M10S 6 角齒輪軸套筒 (140 mm)

- 140 mm long tool is to access the recessed head bolts.
- Dr. 1/2" drive for combining with a torque wrench.
- Application: VW, AUDI cylinder head bolts.

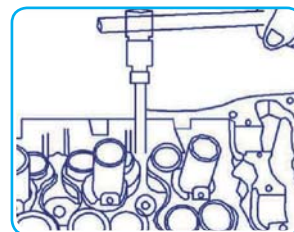



010
HWANG CHERNG BIN
Specialty Tools Inc.

SINCE 1990

General Engine



H.C.B-A1297

FLEXIBLE FLARE NUT COMBINATION WRENCH (7 PCS)

彎頭油管扳手 (7 PCS)

- It is an ideal tool to work in those areas up to 45 degrees that regular flare nut wrenches can't reach.
- Not necessary to remove obstacles from the narrow spaces before loosen or tighten a nut.
- Specification:

ITEM No.	Size (mm)	Length (mm)	Weight (g)
H.C.B-A1297-1	8	129	50
H.C.B-A1297-2	10	129	50
H.C.B-A1297-3	11	148	85
H.C.B-A1297-4	12	148	85
H.C.B-A1297-5	13	175	130
H.C.B-A1297-6	14	175	125
H.C.B-A1297-7	17	190	192
H.C.B-A1297-8	19	190	195



Optional - H.C.B-A1297-8



H.C.B-A2301

NEW

75° BOX END & FLEXIBLE GEAR RATCHET WRENCH WITH GO-THROUGH SOCKET KIT (17 PCS)

穿透式套筒組 (17 PCS)

- 1PCS - 20 mm 75° Box end & flexible gear ratchet wrench with go-through socket wrench handle
- 1PCS - 20 mm x 75 mm (L) Go-through extension bar
- 12PCS - Go-through sockets: 8, 9, 10, 11, 12, 13, 14, 15, 16, 17, 18 & 19 mm
- 1PCS - 20 mm x 1/4" Socket adaptor
- 1PCS - 20 mm x 3/8" Socket adaptor
- 1PCS - 20 mm x 1/2" Socket adaptor

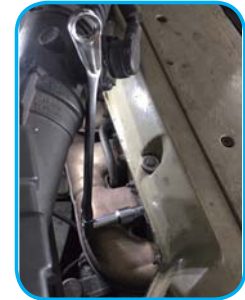

H.C.B-A2302

NEW

DOUBLE FLEXIBLE RATCHET FLARE NUT WRENCH (10 x 12 /13 x 14/15 x 17 mm) (3 PCS)

雙搖頭開口油管扳手 (10 x 12 /13 x 14/15 x 17 mm) (3 PCS)

- These wrenches are upgraded version of the traditional long pipe wrenches which becomes a ratchet pipe wrench that can be used in the brake line, and the small space such as small-angle ABS, EBD, EBC, ESP, etc. In active safety technology.
- The head of this wrench can rotate 180 degrees.
- Color marking buckles, red is forward, black is reversal.
- Car: This size is a common size, or to be in accordance with the various types of vehicles.
- The size of brake systems: 8/10/11/12; The fuel lines with the size: 13/14/15/17
- Mid-size species, large vehicles will become larger.





010
HWANG CHERNG BIN
Specialty Tools Inc.

一般修護工具 引擎
General Engine Repair Tool

H.C.B-A2300 **NEW** **FLEXIBLE CROW'S FOOT SOCKET WRENCH KIT (12 PCS)**

搖頭鴨掌扳手組 (12 PCS)

- 3/8" square drive rotatable head wrenches
- Sizes: 8, 9, 10, 11, 12, 13, 14, 15, 16, 17, 18 & 19 mm
- Rotatable head which can rotate 230 degrees
- Traditional flare nut wrench with crowfoot function.
- Used with F-bar, H-bar, T-bar, speed-handle
- A rotatable crowfoot wrench can be used in hard-to-reach areas with the limit of 110 degrees
- Suitable for all hydraulic, fuel, oil brake, A/C, O2 sensor and air line work.

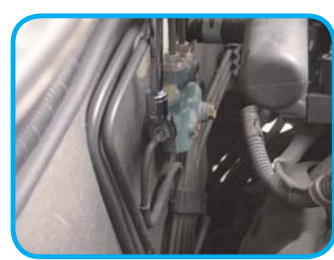

General Engine



H.C.B-A2197 **HEAVY DUTY OIL FILTER CHAIN WRENCH (350 mm)**

鏈條式機油濾芯扳手 (350 mm)

24 / 19.2 / 20.2 / 2'

- Available for all type of oil filter.
- Flexible handle for narrow space.
- Size available: \varnothing 60 mm-105 mm.
- Length of chain: 350 mm.



H.C.B-B2197 **HEAVY DUTY OIL FILTER CHAIN WRENCH (520 mm)**

鏈條式機油濾芯扳手 (520 mm)

24 / 22.6 / 23.6 / 1.9'

- Available for all type of oil filter.
- Flexible handle for narrow space.
- Size available: \varnothing 60 mm-160 mm.
- Length of chain: 520 mm.





H.C.B-A2213

GLOW PLUG SOCKET KIT (5 PCS) (Dr. 1/4", 12 POINTS)

可彎式套筒組 (5 PCS) (Dr. 1/4", 12 角)

20 / 8 / 9 / 0.7"

Size (mm)	Application
8	Peugeot, Renault, Citroen, Ford, Benz...etc.
9	Opel, Fiat, Lancia, Alfa Romeo, Seat, VW...etc.
10	Benz, Peugeot, Audi Seat, VW...etc.
12	Peugeot, Renault Citroen, BMW, Opel...etc.
14	Universal

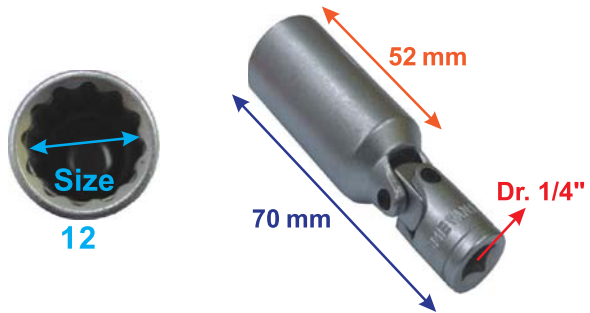

H.C.B-A2094

TWO WAY OIL FILTER WRENCH (60 ~ 80 mm)

二爪正反轉機油芯扳手 (60 ~ 80 mm)

50 / 24.9 / 27.2 / 1.78"

- The tool is used for removing and installing the oil filter.
- Used with Dr. 1/2" or 21 mm wrench.
- Size : range 60-80 mm
- 可用來拆卸和安裝機油芯。
- 可搭配Dr. 1/2"或21 mm扳手使用。
- 尺寸：60-80 mm



H.C.B-B2094

TWO WAY OIL FILTER WRENCH (80 ~ 110 mm)

二爪正反轉機油芯扳手 (80 ~ 110 mm)

25 / 24 / 25 / 1.6"

- The sawtooth design makes it set in place.
- Used with Dr.1/2" or 22 mm wrench.
- Size: range 80-110 mm
- 可用來拆卸和安裝機油芯。鋸齒狀設計，可將工具固定在正確位置。
- 可搭配Dr. 1/2"或22 mm扳手使用。
- 尺寸：80-110 mm



H.C.B-D2094 TWO WAY OIL FILTER WRENCH (104 mm ~ 150 mm)

二爪正反轉機油芯扳手 (104 ~ 150 mm)

- The tool is for removing and reinstalling oil filter.
- Use with Dr. 1/2" or 24 mm wrench.
- Size: range 104-150 mm
- Application: European, Japanese, American cars and FUSO 10.5-17 tons EURO 4.
- 可用來拆卸和安裝機油芯。
- 可搭配Dr. 1/2"或24 mm扳手使用。
- 尺寸：104-150 mm
- 適用車種：歐系、日系、美系車輛及FUSO 四期環保10.5-17噸卡車



H.C.B-A1310-14 FLARE NUT WRENCH (Dr. 3/8" x 14 mm)

單開口扳手 (Dr. 3/8" x 14 mm)

- For TOYOTA, HONDA bolts of fuel filter and tube.
- Full Length: 93 mm , suitable for narrow space
- Holding the nut completely and prevent slipping

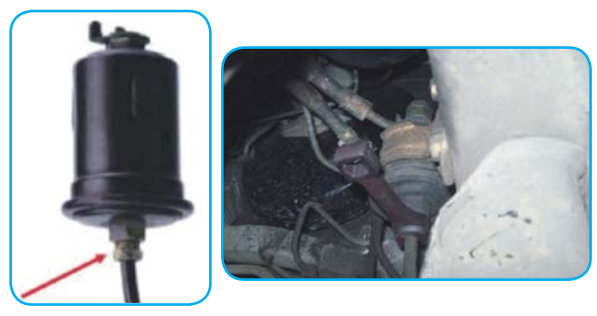

H.C.B-A1310-17 FLARE NUT WRENCH (Dr. 1/2" x 17 mm)

單開口扳手 (Dr.1/2" x 17 mm)

- For TOYOTA, HONDA nuts of fuel filter.
- Full Length: 93 mm, suitable for narrow space
- Holding the nut completely and prevent slipping.

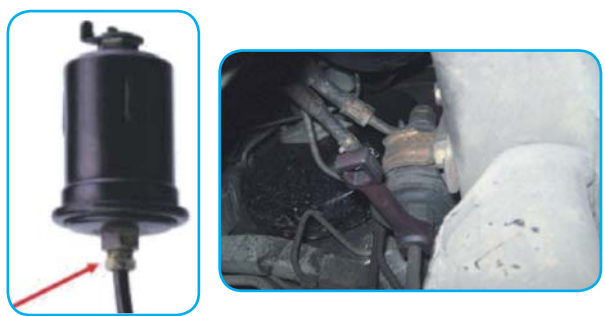



H.C.B-A2098

HOUSING DISASSEMBLE KIT

端子拆卸盒

■ Operation:

1. Detach the plastic box first and easily operate for any callow user.
2. Put the plastic bolt aside from the oblique of approximate 30 degrees.
3. Take the terminal out, then clean or correct or replace it.

■ Characters:

1. Five types of terminal disassemble kit for market demand.
2. Easy, rapid and convenient to take out the terminal and don't damage the terminal head.
3. Repair the cable head easily.

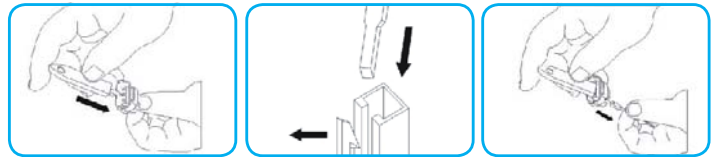

H.C.B-A2114

OIL PAN SEPARATOR TOOL

油底殼密合處分離器

- Wide, tapered, round blade edges between metal surfaces to break gasket seals on engine pumps, transmissions or any difficult to separate gasket joints.

- Blade width: 47 mm

- Length: 70 mm

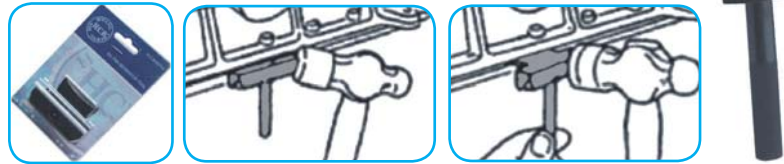

H.C.B-A2125

FAST CHECK WIRE-CLIP

快速查線夾

100 / 18 / 18.8 / 3.2'



Connecting cable

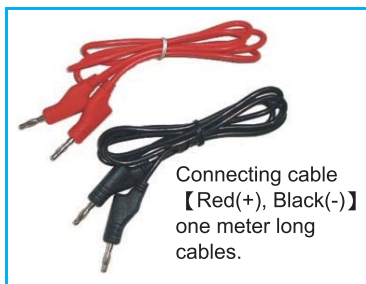

Connecting cable
【Red(+), Black(-)】
one meter long cables.

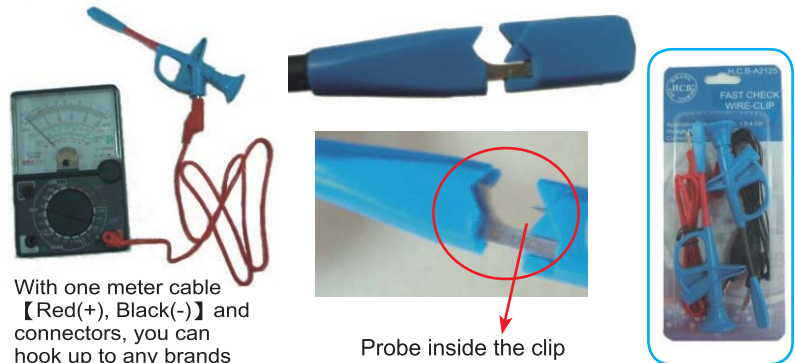

With one meter cable
【Red(+), Black(-)】 and
connectors, you can
hook up to any brands
of multiple-meters.

Probe inside the clip



Fast, easy
check.

No damage
to wires.



With connecting to any
brands of multiple-meters,
you can easily get the
reading of voltage, resistance,
and current, nice tool for
wiring troubleshooting.

H.C.B-B2031

UNIVERSAL LINE KIT

萬用線組

5 / 12.35 / 13 / 2.72'

■ The line kit with multi-function.



Variable resistance (5KΩ)



LED examining light



SRS replacing & testing device



Crocodile Clip



Measure Stick



Various types of probes



One to two form



Referring to the picture



Round Shape Connector



One to one form



Referring to the picture



Flat Shape Connector

H.C.B-C2031

SIMPLY UNIVERSAL LINE KIT

簡易型萬用線組

25 / 13.5 / 16.3 / 3.3'



Component No.	Quantity(pcs)	Length(cm)	Name	Description	Picture
1. Acicular Probe	4	21.3	Various types of probes	Please pay attention to the touching angle when the probe is used to avoid the accident. (It is made of HCS for better tough hardness.)	
2. Probe	2	12.43	Stick Measure	Users can examine and measure according to demand, it can be used with Alligator Clip, extension line, etc.	
3. Alligator Clip	2	8.58	Alligator Clip	Users can examine and measure according to demand, it can be used with Measure Stick, extension line, etc.	
4. Led Stroboscope	2	12.7	LED examining light	The color of LED light will change when the anode & the cathode of two-color and double-way LED light change	
5. Connecting Cable	4	106 cm & 53 cm	Connecting Cable	【Red(+), Black(-)】 100cm & 50cm long cables	
6. Fast Check Wire-Clip	1	16.55 cm	Fast Check Wire-Clip	Fast check wire-clip makes wiring check easy and accurate without damage on wires. With connecting to any brands of multiple-meters, you can easily (quickly) get the reading of voltage, resistance, and current, Nice tool for wiring troubleshooting.	



H.C.B-A2121

PORTABLE POWER STATION (FOR SEDAN)

電霸 (一般轎車用)

3 / 28.5 / 29.5 / 0.58'

- Don't worry when your car's battery is dead.
- Prevent audio from locking up or computer shutting down when changing the car battery.
- Power supplier for home electric appliances.
- Emergency power supply.
- Easy and quick charge.
- Portable, rechargeable, cordless, easy to carry along in vehicles or boats.
- Powerful enough to start engine.
- No need other vehicle or booster cables.
- Safe and sealed battery won't be leak or spill.
- Polarity protection device if clamps connected to battery poles in reverse. And prevent clamps from sparking if the 2 clamps touched together.

- 當車輛電瓶沒電時，毋需擔心。
- 可避免在更換電瓶時，發生音響或電腦當機。
- 可使用家用電源來充電。
- 緊急的電源供應器。
- 充電簡單、快速。
- 手提、可重覆充電、無線，易於攜帶在車或船上。
- 強效電力，可啟動引擎。
- 不需要其他車輛或電纜。
- 安全、密封式電池，不用擔心溢漏。
- 電極保護裝置可避免接錯電或兩個夾子互相接觸引發的短路。



Battery : 12V/17AH



H.C.B-B2121

PORTABLE POWER STATION (FOR VEHICLE)

電霸 (汽油車, 柴油車用)

3 / 26 / 26.5 / 2.03'

- Don't worry when your car's battery is dead.
- Prevent audio from locking up or computer shutting down when changing the car battery.
- Power supplier for home electric appliances.
- Emergency power supply.
- Easy and quick charge.
- Portable, rechargeable, cordless, easy to carry along in vehicles or boats.
- Powerful enough to start engine.
- No need other vehicle or booster cables.
- Safe and sealed battery won't be leak or spill.
- Polarity protection device if clamps connected to battery poles in reverse. And prevent clamps from sparking if the two clamps touched together.

- 當車輛電瓶沒電時，毋需擔心。
- 可避免在更換電瓶時，發生音響或電腦當機。
- 可使用家用電源來充電。
- 緊急的電源供應器。
- 充電簡單、快速。
- 手提、可重覆充電、無線，易於攜帶在車或船上。
- 強效電力，可啟動引擎。
- 不需要其他車輛或電纜。
- 安全、密封式電池，不用擔心溢漏。
- 電極保護裝置可避免接錯電或兩個夾子互相接觸引發的短路。



H.C.B-C2121

PORTABLE POWER STATION (FOR 230 V/50 Hz)

電霸 (230 V/50 HZ)

1 / 9 / 9.5 / 0.64'

- LED Operation Function:
The power pak battery voltage level is indicated by the LED's:
Green >12.8V
Yellow 12.2-12.7V
Red <12V
- Low Voltage Warning-Buzz warning for low battery and naturally discharge/ unload the voltage down to 7V ± 0.5V.
- LED指示功能：電霸的電量可由LED的燈色來表示。
綠 > 12.8V
黃 12.2-12.7V
紅 <12V
- 低電量、或電量不足7V ± 0.5V時，會響起警告聲。



H.C.B-D2121

PORTABLE POWER STATION (FOR VEHICLE)

電霸 (電力士)

6 / 23.5 / 24 / 1.11'

- It's the lightest in the market, the weight only 3.3 kg , easy operation and stock.
- Powerful enough to start engine of under 3500 c.c. vehicle.
- It can power supply alone , don't need another vehicle.
- The battery charger is designed automatic disconnection power supply so battery life can be prolonged.
- It also can supply for lots of equipment of vehicle (ex. mobile phone , intercom of vehicle, vacuum cleaner).
- 淨重3公斤，是市售最輕的電霸。便於操作和存放。
- 強效的電力，足以發動3500 c.c.以下的車輛引擎。
- 可單獨供電，不需藉助其他的車輛。
- 自動斷電設計，可延長電霸的壽命。
- 也可以做為車上其他設備的電源。(例如：手機、對講機和吸塵器)



H.C.B-B2119

INFRA-RED TEMPERATURE PICK-UP

紅外線溫度槍

INFRARED THERMOMETER:

Display	Backlight LCD display
Measurement Range	-35°C ~ 500°C (-4°F ~ 932 °F)
Resolution	0.1 °C / 0.2 °F
Accuracy	±2% reading or ±2°C
Spectral Response	6 ~ 14 μm
Field of View	10 : 1 optics ratio with a 1" min target
Emissivity	0.17 ~ 1.00, (1326: fixed 0.95)
Sighting	Laser marker < 1mw





H.C.B-A2100 CURRENT LEAKAGE TESTER FOR IGNITION ACTION

漏電測試器

4 / 6 / 7 / 2.8'

Contents:

- Ignition leakage catcher probe.(one)
- Alligator clip,ground cables(two)
- Spark plug firing tester (two)
- Manual (one)

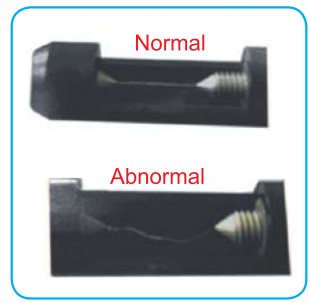

Features:

- Easy and safe to catch ignition leakage. Use ignition leakage catcher probe to the firing system component which is suspicious leakage. If the light on the handle illuminates, it indicates ignition leakage.
- Ignition leakage catcher guide can be used with spark plug firing tester to inspect disdirect type spark plug leakage around the connectors.
- Spark plug firing tester is applicable to all kinds of coils and ignition wires.
- Easy to read the joules on coil wires, distributor cap and plug wires from the different ignition type checked with the specifications.
- Absolutely isolation, no danger during the operation.

Cylinder compressed pressure	Standard tester gap
9.5:1 below	1 cm
9.5:1 ~ 10.5:1	1 ~ 2 cm
10.5:1 ~ 11.5:1	2 ~ 3 cm

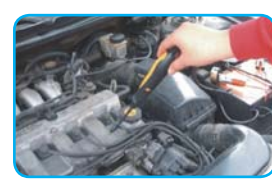

Operational demo



Ignition leakage catcher & spark plug firing tester

H.C.B-A2192 OIL DRAIN REPAIR KIT

油底殼螺絲更換組

- Disassemble the damaged oil drain screw.
- Choose a tap. For example, if the original diameter of oil drain hole is M14, then operator needs a M15 tap.
- Enlarge the diameter of oil drain hole by the tap.
- Take a washer through a new oil drain plug, and insert them into the oil drain hole.

Item No.	Size	Tap	Oil Drain Plug	Cooper Washer
H.C.B-A2192-13	M13 x P1.5	1 pc	6 pcs	12 pcs
H.C.B-A2192-15	M15 x P1.5	1 pc	6 pcs	12 pcs
H.C.B-A2192-17	M17 x P1.5	1 pc	6 pcs	12 pcs
H.C.B-A2192-20	M20 x P1.5	1 pc	6 pcs	12 pcs
H.C.B-A2192-22	M22 x P1.5	1 pc	6 pcs	12 pcs



H.C.B-A2192-13



H.C.B-A1371 ELECTRONIC TORQUE SCREWDRIVER

電子式扭力螺絲起子

- Range: 0~20 Nm.
- This tool sounds and vibrates to warn when over the set torque.



H.C.B-B2192 OIL DRAIN REPAIR KIT

油底殼螺絲更換組

8 / 20 / 21 / 2.2'

- Renew the diameter and replace a new oil drain plug.
- Six popular sizes fit nearly all applications.
- Material: Tap:SKS3
Oil drain piug: 1015
Washer: Copper

Size	Tap	Oil drain plug	Washer
M13 x P1.25	1 pc	6 pcs	12 pcs
M13 x P1.5	1 pc	6 pcs	12 pcs
M15 x P1.5	1 pc	6 pcs	12 pcs
M17 x P1.5	1 pc	6 pcs	12 pcs
M20 x P1.5	1 pc	6 pcs	12 pcs
M22 x P1.5	1 pc	6 pcs	12 pcs



H.C.B-B2160 50L WASTE OIL DRAINER (MANUAL)

手動升降式佇油機 (50 升)

- Gravity drain using tap on rear of unit. Includes visible 'Full Drum' device.
- Include large diameter drain pan insert and heavy duty mesh for draining oil filters.
- High density Polyethylene.
- Manual operation
- Dimension: 550 x 550 x 900-1070 mm
- Capacity: 50 L
- Weight: 12 KGS



H.C.B-A2160 WASTE OIL DRAINER (80 L)

廢油桶 (80 升)

- Waste oil mobile reservoirs for motor and gear oil collection .
- Drainers can be used under vehicle lifts or inside lubrication pit.
- Large handle for easy maneuverability.
- Two brake wheels (3") and two casters (3")
- Extra large drain bowl / Adjustable collecting bowl / For the convenient and safe collection

■ **Specification**

Model	H.C.B – A2160
Dimension	470 x 560 x 1140~1580 mm
Capacity	80 L
Weight	36 KGS
Oil Draining	Compressed Aiv 100~120 PSI
Power	Air Pressure

■ **Accessory:**

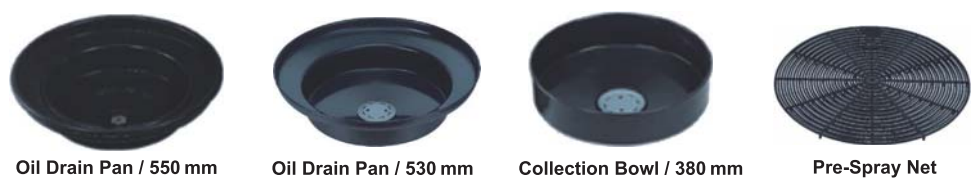



H.C.B-A2310

NEW

OIL DRAIN PAN

油盤

Contents:

Item no.	Capacity	Weight	Dimension of product
A2310-035	3.5 L	284 g	410 (L) x 330 (D) x 100 (H) mm
A2310-080	8 L	566 g	502 (L) x 400 (D) x 132 (H) mm
A2310-160	16 L	952 g	582 (L) x 472 (D) x 156 (H) mm



Features & Benefits:

- This Oil Drain Pan includes easy grip, large carrying handles and integral spout for pouring waste oil or fluids into a recycling container.
- The anti-splash lip prevents spillage. Ideal for draining antifreeze or oil.
- Meets **PAHs /REACH** regulations
- ※Not suitable for spray gun cleaner

H.C.B-A2312

NEW

2L OIL DRAIN PAN

2L 油盤

Features & Benefits:

- Catch the engine waste oil when changing the Motorcycle's engine oil.
- The 2 Liter Drain Pan also can use in catch the cleaning solvent when cleaning the Motorcycle's chain.
- The front side opening design for easy dumping of oil collection.
- Capacity: 2 Liters
- Material: Polyethylene (PE)
- Dimension of product: 380 (L) x 212 (D) x 73 (H) mm
- Weight: 240 g ~ 270 g



H.C.B-A1396

MITSUBISHI/ KIA ENGINE BALANCE SHAFT O-RING REMOVER SOCKET

三菱 /KIA 平衡軸套筒

- For removing the o-ring of engine balance shaft.
- The special socket will remove the special screw on the o-ring and then replace the o-ring easily.
- Application: Mitsubishi, KIA

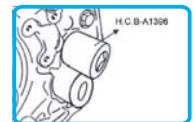
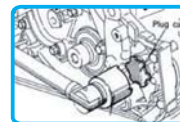

H.C.B-A1417

FUEL FILTER LID WRENCH (Dr.3/8", 108 mm)

汽油箱蓋拆裝器 (Dr. 3/8", 108 mm)

- For removing and installing the fuel filter cap when replacing the fuel cartridge.
- Used to avoid damage to components when working on fuel system.
- Application: PEUGOET, CITROEN,RENAULT with HDI ENGINES

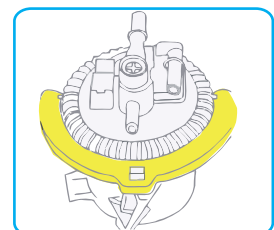
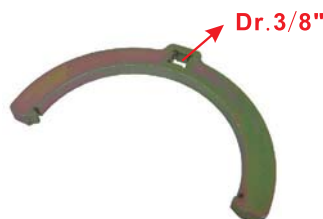

H.C.B-A1418

FUEL FILTER LID WRENCH (Dr. 3/8", 8 RIBS, 109 mm)

汽油箱蓋拆裝器 (Dr. 3/8", 8 齒, 109 mm)

- Size: Dr. 3/8", 8RIBS, 109 mm
- Used to avoid damage to components when working on fuel system.
- Application: PEUGOET, CITROEN,RENAULT

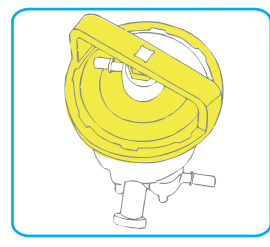
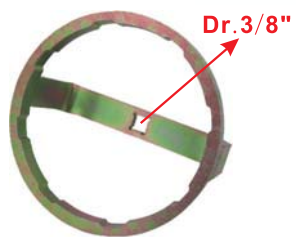

H.C.B-C2250

NEW 8 PCS SPECIALIST SOCKET KIT (Ribe sockets: 1/2" Dr. x M6S, M8S, M10S, M12S/Pentagon sockets: 1/2" Dr. x 10, 12, 14, 19 mm)

8 PCS 特殊套筒組 (Ribe sockets: 1/2" Dr. x M6S, M8S, M10S, M12S/Pentagon sockets: 1/2" Dr. x 10, 12, 14, 19 mm)

- Special ribe and pentagon sockets for removing some special screws on vehicle. Such as engine head screws, idle wheel center screws, and etc.
- Contents : Ribe sockets: 1/2"Dr. x M6S, M8S, M10S, M12S
- : Pentagon sockets: 1/2" Dr. x 10, 12, 14, 19 mm



H.C.B-A2250

13 PCS SPECIALIST SOCKET KIT

13 PCS 特殊套筒組

- A range of specialist sockets for a variety of applications and vehicles.
- Impact quality.

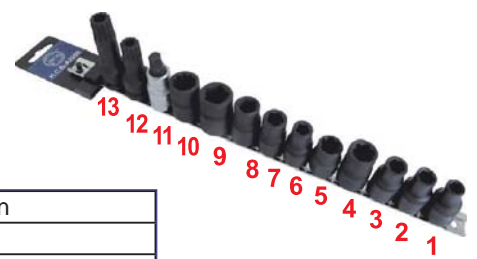

	Socket Size	Socket Type	Vehicle	Application
1	6S (D1223)	Special 6 Point	Nissan Renault	Clutch
2	8S (C1223)	Special 6 Point	Nissan	Cylinder head and balance shaft screw
3	8TS (E1223)	Special 3 Point	Nissan	Balance shaft screw
4	12S (B1223)	Special 6 Point	Nissan	Head bolts
5	10S (A1223)	Special 6 Point	Toyota	Idle wheel Centre Screw
6	10mm (A2241)	Pentagon		Brakes
7	12mm (A2242)	Pentagon	Nissan	Fuel Pump
8	14mm (A2131)	Pentagon	General Motors Smart Car	
9	19mm (A2071)	Pentagon	Citroen Peugeot Renault	Brakes
10	20mm (A2180)	10 Point	Honda Civic Honda CR-V	Rear Trailing arms
11	10mm (A2072)	Pentagon Insert Bit Socket		Girling brake system
12	M16 (A2070)	Spline Impact Bit Socket	AUDI: A3 A4 A6 VW :Gold IV	Transmission /gearbox drain plug
13	M18 (B2070)	Spline Impact Bit Socket	VW	half-axes.





H.C.B-A2241 PENTAGON SOCKET (Dr. 1/2", 10 mm)

內五角套筒 (Dr. 1/2", 10 mm)

- Impact quality.
- Application: Brakes



H.C.B-A2242 PENTAGON SOCKET (Dr. 1/2", 12 mm)

內五角套筒 (Dr. 1/2", 12 mm)

- Impact quality.
- Application: Nissan Fuel Pump



H.C.B-A2249 13 PCS SPECIALIST SOCKET KIT (HEX)

13 PCS 特殊套筒組 (六角)

	Socket Size	
1	6mm	Dr. 1/4"
2	7mm	Dr. 1/4"
3	8mm	Dr. 1/4"
4	9mm	Dr. 1/4"
5	10mm	Dr. 1/4"
6	12mm	Dr. 3/8"
7	14mm	Dr. 3/8"
8	17mm	Dr. 3/8"
9	18mm	Dr. 3/8"
10	19mm	Dr. 3/8"
11	MT14	Dr. 1/2"
12	MT16	Dr. 1/2"
13	MT18	Dr. 1/2"



Material: CR-MO with Sand Blasted & Zinc Phosphate
 Contents:
 5 - 1/4" Dr. : 6-7-8-9-10 mm x 20 mm (L)
 5 - 3/8" Dr. : 12-14-17-18-19 mm x 30 mm (L)
 3 - 1/2" Dr. Tamper.spline: M14-16-18 x 38 mm (L)

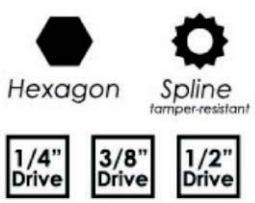

H.C.B-A1469 7 PCS Dr.1/4" TX-STAR BALL END INSERT BIT SOCKET KIT

7 PCS Dr.1/4" 球型扳手

- Screwdriver bits sockets with ball head, T-profile without hole 6.3 mm (1/4") drive, 130 mm long, for spots that are difficult to reach.



Part No.	Description	Q'ty
A1469-010	T10x130 (L)	1
A1469-015	T15x130 (L)	1
A1469-020	T20x130 (L)	1
A1469-025	T25x130 (L)	1
A1469-027	T27x130 (L)	1
A1469-030	T30x130 (L)	1
A1469-040	T40x130 (L)	1

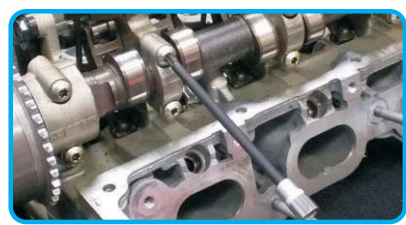

H.C.B-A2237 DISC BRAKE PISTON TOOL

碟煞活塞調整器

- Used on vehicles with four wheel disc brakes.
- Use with 3/8" drive ratchet and extension.

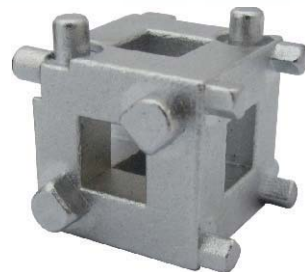

H.C.B-A2244 DIESEL COMPRESSION TESTER (37 PCS)

柴油測試組 (37 PCS)

Contents:

- For removing original injector or glow plug.
- Choose suitable test parts with appropriate length to match original injector/ glow plug.
- Connect with gauge and start engine for compression testing.

Features:

- Common checking diesel compression tester with wide range adapto..
- Test process must be under vehicle cranking condition.
- Provided high quality hydraulic gauge with modern design rubber jacket.
- Full glow plug and injector adaptors.
- Additional clamp-on adaptors in case provide more application to truck, van, bus, marine, and agricultural vehicles.



H.C.B-A2248 GLOW PLUG DRILLING KIT (16 PCS)

預熱塞拔脫器 (16 PCS)

- For extracting the damaged/ sized glow plugs on many modern diesel engines easily.
- Without removing cylinder head and avoid damaging cylinder head casting.
- Suitable for Mercedes-Benz CDI diesel engine.



ITEM No:	Description
1	Ratchet T-Bar
2	Drill 9x4.2 mm
3	Drill 7x5.5 mm
4	Top connection removal tool star socket (9.2 mm square socket)
5	Alley key 3mm
6	Ø6*3.5*40L
7	Tap, M10x P1.0
8	Tap, M8x P1.0
9	Tap, M5x P 0.8
10	Spindle M5x0.8P
11	Pilot drills 3.5mmx2 pcs
12	Puller outer housing(Hex 12 mm spindle) (Hex 30mm Force nut)(cone center tool)
13	Drill Installer





010
HWANG CHERNG BIN
 Specialty Tools Inc.

SINCE 1990

General Engine



H.C.B-A1497 ALUM-A-STACK HYDRAULIC RAM KIT

堆疊式油壓組

- Convenient kit allows you to select your ram length
- 10 Ton ram include 1" (2.5 cm), 2" (5 cm) and 3" (7.5 cm) extensions
- Extensions can be used individually or joined
- Ships in carrying case
- Weight: 4.3 kg
- Retracted height: 3.5" (9 cm)
- Stroke length: 1.5" (3.8 cm)



H.C.B-A1499 RENAULT (1.8/2.0 16 V) BELT DRIVE PETROL ENGINE CAMSHAFT SPROCKET LOCKING DEVICE

雷諾正時工具組 (1.8/2.0 16 V)

- Required for releasing the camshaft sprocket bolts when timing engines, after belt replacement.
- Suitable for locking the camshaft sprockets in order to release the centre bolts on Renault 1.8, 2.0 16v engines
- Suitable for locking the camshaft sprockets in order to release the centre bolts on Renault 1.8, 2.0 16v engines
- Engine code: 1.8 16v - F4P, 722, 770, 721, 722, 773, 774, 775, 2.0 16v - F4R, 700, 701, 712,713, 714, 715, 720, 730, 732, 736, 738, 740, 741, 744, 746, 747, 760, 761, 762, 763, 764, 765,766, 767, 770, 771, 774, 776, 784, 786, 787, 790, 792, 794, 795, 797, 830
- Application: Renault 1.8 – Laguna II (01-05), 2.0 - Laguna II, Megane II, Scenic (02-09)
- OEM no. ref.: 1509/01



H.C.B-A2252 RETURN FUEL VOLUME TESTER FOR COMMON RAIL INJECTORS (6 V)

柴油燃油測試組 (6 V)

Kit Specification & Application

- 1 off measuring unit with 6 off 800 mm rubber hoses.
- 1 set (6 unit) C1 adapters for BOSCH injectors
- 1 set (6 unit) C2 adapters for SIEMENS injectors
- 1 set (6 unit) C3 adapters for DENSO injectors
- 1 set (6 unit) C4 plastic adapters for DEPHI injectors

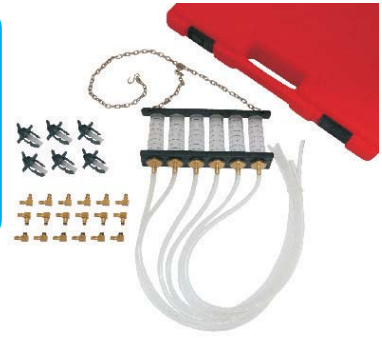

- Measure return fuel flow from diesel common rail system.
- Simple test for rough or bad engine starting & power.
- 800 mm hose can easily connect with original clip.
- Testing with running engine.

H.C.B-A2255 Dr. 3/8" AND Dr. 1/2" SCREW EXTRACTOR KIT (9 PCS)

螺絲破壞器 (9 PCS)

- Material : SNCM-V with phosphate coating.
- 3/8" Dr. : 3, 4, 5, 6, 7, 8, 10 mm, hexagon 17 mm, 38 mm long.
- 1/2" Dr. : 12-14 mm, hexagon 22 mm, 44 mm long.
- Designed to remove broken screws, studs and fittings.



3/8" SQ.Dr.

1/2" SQ.Dr.

H.C.B-A2261 UNIVERSAL Dr. 1/2" STUD EXTRACTOR (FOR 6.0 X 12.0)

通用無頭螺絲拆卸器 (FOR 6.0 X 12.0)

- Infinitely adjustable.
- Ideal for bolts with rusted or stripped threads.
- Also for bolts with undersize.
- This tool will also remove damaged nuts
- Due to the nature of the task the jaws are consumable
- Hex Drive can be driven with wrench or impact tool.
- Universal tool for studs with diameter 6 - 12 mm. Suitable even for broken screws when the rest length is at least 5 mm.

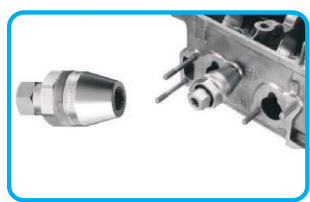

H.C.B-A2263 UNIVERSAL GM, CHRYSLER, MITSUBISHI HARMONIC DAMPER PULLEY PULLER

通用 GM/CHRYSLER, MITSUBISHI 皮帶輪拆卸工具

- This unique tool has been developed to aid in the removal of the harmonic damper pulleys found on many CHRYSLER · G.M · MITSUBISHI engines.
- This pulley is hard to access and remove due to space limitations in and around the engine compartment.
- In most cases this compact tool eliminates the need of a technician to go through the time consuming process of first removing the radiator before being able to remove the pulley.
- This low profile puller has been designed for use on the following automobiles, SUV's, vans & pickups: RE-ENGINEERED to fit the following additional Chrysler & GM applications: This unique tool has been developed to aid in the removal of the harmonic damper pulleys found on many CHRYSLER · G.M · MITSUBISHI engines. This pulley is hard to access and remove due to space limitations in and around the engine compartment. In most cases this compact tool eliminates the need of a technician to go through the time consuming process of first removing the radiator before being able to remove the pulley. This low profile puller has been designed for use on the following automobiles, SUV's, vans & pickups: RE-ENGINEERED to fit the following additional Chrysler & GM applications:





H.C.B-A2266

UNIVERSAL HYDRAULIC FLARING TOOL KIT

液壓夾管成型器

- This flaring kit includes various sizes of dies and adapters to work on flaring tube of GM fuel line, brake line, transmission line and A/C line.
- One 45 degree adapter is suitable for working a double flare.
- A big handle on the hydraulic pump helps save energy.
- The set is packed with a case for easier and safer storage for dies and adapters.
- Specification:
Push-Connect: 1/4", 5/16" and 3/8"
GM Fuel Line: 5/16" and 3/8"
Single/Double: 3/16", 1/4", 5/16", 3/8" and 1/2"
Metric Bubble: 4.75 mm, 6 mm, 8 mm and 10 mm



H.C.B-A1527

PEUGEOT ENGINE MOUNT BUSH REMOVER/ INSTALLER

標緻 (PEUGEOT) 引擎座鐵套拆裝工具組

- Application:

Position of Bush	Model	Piston Displacement	Dimension of bush	OEM NO.
RIGHT FRONT OF ENGINE	406	3,000 c.c.	Big	184442
RIGHT FRONT OF ENGINE	406	2,000 c.c.	Big	184442
RIGHT FRONT OF ENGINE	206	2,000 c.c.	Big	184442
RIGHT FRONT OF ENGINE	206	1,600 c.c.	Small	184477
RIGHT FRONT OF ENGINE	206	1,400 c.c.	Small	184477
RIGHT REAR OF ENGINE	406	3,000 c.c.	Big	180933
RIGHT REAR OF ENGINE	406	2,000 c.c.	Big	180933
RIGHT REAR OF ENGINE	206	2,000 c.c.	Big	180933
RIGHT REAR OF ENGINE	206	1,600 c.c.	Small	184454
RIGHT REAR OF ENGINE	206	1,400 c.c.	Small	184454



Right rear bush of engine



Right rear bush of engine



OEM No.:180933 OEM No.:184454 OEM No.:184477 OEM No.:184442

With this tool, you will not have to remove the engine seat and you can remove or install directly on the car. This tool will save your time and do this thing conveniently.



Right rear bush of engine -removal



Right rear bush of engine -installation

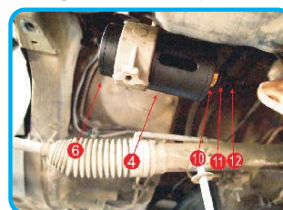

Right rear bush of engine - removal

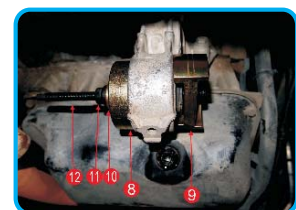

Right rear bush of engine - removal

- Application:
PEUGEOT 406 (3000 c.c.) 、 406 (2000 c.c.)
PEUGEOT 206 (2000 c.c.)

- Application:
PEUGEOT 206 (1600 c.c.) 、 206(1400 c.c.)

H.C.B-A1531

INJECTOR RAIL ASSEMBLY REMOVER

噴油嘴拆卸工具

- The fuel rail and injector assembly used on the Hitachi SIDI system on 2010 LF1 3.6L V6 and LAF 2.0L ECOTEC has two seals on each injector, and these seals are installed with very tight tolerances.
- Once the engine has been run, injector and rail removal is very difficult, and the assembly must be removed as straight as possible to prevent the chance of damaging an injector bore in the cylinder head, or to the mount assembly.
- Each mount assembly contains an isolator, and cannot have any force applied to the mount for removal.
- A1531 installs in place of the mounting bolts, and reaches under the injector rail near each mount location.
- The hand wheels on A1531 at each mount location are tightened evenly to un-seat all injectors evenly, preventing damage to the injectors, cylinder head, and rail mount assemblies.



H.C.B-A1537

HYUNDAI INJECTOR REMOVER

HYUNDAI 噴油嘴拆卸工具

- This kit is designed to remove stuck injectors from most Korean vehicles
Suits: Kia Models
- **Application:**
Hyundai Models
Starex, Lativa, Matrix, Trajet, Terracn,
Santa Fe (sm), Libero, Avante XD,
Grandeur XD,
Getz, Tucson, NF Sonata, 06 Accent
4044 4044



H.C.B-A2274

CAM AND CRANKSHAFT SEAL PULLER

曲軸 / 凸輪軸油封拉拔器

- Engage the adjustable hook behind the seal.
- Brace the push rod against the engine head then push the handle to remove the seal.
- Remove the seal easily & quickly without damage to the cam & crank shaft.



H.C.B-A2279

UNIVERSAL OIL FUNNEL KIT

萬用型漏斗組

- The width of the clamp is automatically adjustable 28 mm-74 mm (1.1in-2.9in).
- The funnel has a thread that fits perfectly in the clamp.
- The funnel has a special transparent design in the lower chamber to see the passage of the oil.
- No need to hold the funnel with your hand when refilling the oil.





H.C.B-B2279 OIL FUNNEL FOR SUBARU

SUBARU 漏斗

- Suitable for all SUBARU models with small oil filler neck.
- No more unsafe spills.
- Transparent lower chamber design clearly shows oil flow process.
- Large oil passage shortens oil fill time.
- Remove oil filler cap from the vehicle, and install funnel onto the oil filler neck securely.
- Prepare engine oil for refilling process without spilling.
- Application:

Brand	Model	Year
Subaru	B9 Tribeca	2006-2007
Subaru	Baja	2005-2006
Subaru	Forester	1998-2012
Subaru	Impreza	1993-2012
Subaru	Justy	1989-1994
Subaru	Legacy	1990-2012
Subaru	Outback	2001-2012
Subaru	SVX	1994-1997
Subaru	Tribeca	2008-2012

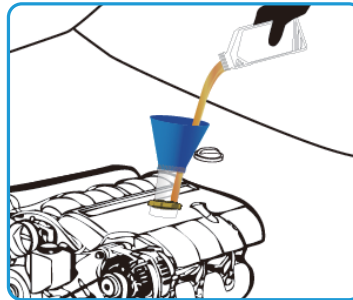

H.C.B-C2279 FLEXIBLE FUNNEL

可彎式漏斗

- Bring much convenience to an auto repairing service shop.
- Particularly useful when draining and refilling different types of fluids in a vehicle, such as brake fluid, engine oil, transmission fluid, coolant and so on.
- Useful when operating in limited spaces.
- Easy to store flat or rolled up in toolbox.
- Length: 372 mm
- Width: 170 mm
- Inside material: Aluminium
- Outside plastic material: NBR

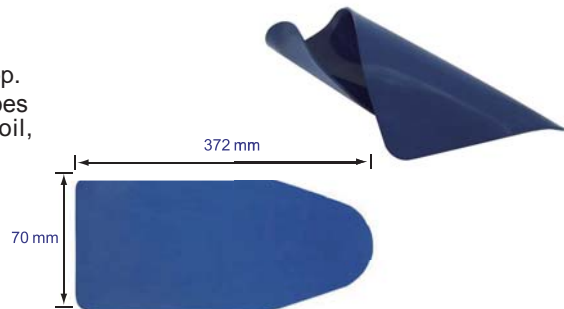

H.C.B-A2297 OIL/BRAKE FLUID INSPECTION SYRINGE (200 ml)

NEW

機油 / 剎車油注射器 (200 ml)

- Transparent design allows the clear view of the fluid
- Suitable for fluid suction and injection when doing vehicle service
- Made from composite plastic which is resistant to brake fluid and antifreeze
- 200 c.c. capacity with quick disconnect tube



H.C.B-B2297 MULTI-PURPOSE SYRINGE (1.5 L)

NEW

多功能注射器 (1.5 升)

- Transparent design allows a clear view of the fluid.
- Suitable for fluid suction and injection when doing vehicle service
- Ideal for applications such as engine/gear oil and differential fluid changes.
- 1.5 L capacity with rotatable switch off



H.C.B-C2297

NEW

DIESEL / PETROL FUEL SYRINGE (1.5 L)

柴 / 機油真空抽取注射器 (1.5 升)

- 1.5 liters
- Designed for both petrol and diesel vehicles, to retrieve excess fuel from fuel lines before maintenance.
- Eliminate the risk of fuel spills and damage to pipes, if clamped.
- Connectors for PSA/Vauxhall/Opel vehicles and two universal connectors for older cars.
- Prevents spillage.
- Adaptor 3/8" (Male)
- Adaptor 5/16" (Male)
- Connector Assembly 5/16" (Female)
- Adaptor Universal
- Connector Assembly 3/8" (Female)



H.C.B-A2303

NEW

ENGINE OIL FUNNEL KIT (7 PCS)

引擎油加油蓋組 (7 PCS)

- Include six adaptors to fit over a hundred models
- DO NOT USE BRAKE CLEAN! Using brake parts cleaner or parts washer on plastic voids warranty. DO NOT USE BRAKE CLEAN!
- **Application:**
Orange Adaptor for VAG/BMW
Silver Adaptor for VOLVO
Green Adaptor for TOYOTA
Black Adaptor for SUBARU
Blue Adaptor for FORD(MAZDA)(Hyundai diesel)
Red Adaptor for HONDA(Hyundai 16V)(NISSAN 2.5)



H.C.B-A2304

NEW

OIL FILLER FUNNEL TOOL KIT (7 PCS)

加油漏斗蓋組 (7 PCS)

- Oil filler kit for modern engines
- 1 liter funnel
- Prevents oil leakage when refilling with engine oil avoiding contamination of engine block, exhaust manifold etc
- Suitable for bayonet fittings on all VAG models plus screw fittings in 4 thread sizes
- For pouring oil where access is difficult
- Designed to effectively seal onto the engine's oil filler aperture thus avoiding spillage onto the cam cover, engine block or exhaust manifold.



Name	Qty
Angled Aluminium Extension	1
Bayonet Adaptor Fitting - BMW, Dodge, Mercedes Benz, VAG	1
Funnel	1
Sealing Connector Adaptor - BMW V6 & V8 (1996-2013)	1
Sealing Connector Adaptor - Dodge Sprinter	1
Sealing Connector Adaptor - Mercedes Benz 112 & 113 engines	1
Sealing Connector Adaptor - VAG 1.8T, 1.9 TDI, 2.0T, 2.8L, 3.0L, 3.2L, 3.6L, 4.2L	1
Sealing Connector Adaptor - Volvo 2.5T	1
Threaded Adaptor (M32 x 3.5) Some Ford, Jaguar, Honda, Mazda & Nissan	1
Threaded Adaptor (M35 x 4.0) Most Mazda	1
Threaded Adaptor (M37 x 3.0) Lexus & Toyota (exc. Prius & Yaris)	1
Threaded Adaptor (M42 x 4.5) Subaru All Models (exc. Tribeca)	1





H.C.B-A2298

NEW

BRAKE BLEEDER WRENCH KIT W/ CHECK VALVE

簡易型剎車油更換扳手加附逆止閥配管

- Internal seals for longer lifespan
- Set of special socket wrenches for loosening & tightening bleed nipples of 7, 8, 9, 10 & 11 mm to cover all popular applications
- 1.2 meters silicon hose with safety check valve
- For bleeding brake and clutch hydraulic systems without removing the wheels



H.C.B-A2290

FLEXIBLE HOSE CLIP NUT DRIVER

軟性套筒起子

- Comfortable, high-grip, textured handle.
- Simplify the tightening/loosening of those awkwardly positioned hose clips.
- Blade Material: WIRE STEEL
- Handle Material: TPR+P.P
- Flexible Shaft Length: 150 mm
- Overall Length: 260 mm



H.C.B-A1611

STEERING FIXED BASE

方向盤固定器

- This tool is designed to fix the steering wheel.
- Description:
 1. When the vehicle front wheels are incorrect, you can use this tool to align the steering wheel and the front wheels.
 2. After the steering box is removed, it will idle run. If you don't fix the steering wheel, it will damage the internal coil of the airbag.
- So this is the necessary tool!



H.C.B-B2124

NEW

3/8" OIL DRAIN SOCKET KIT (15 PCS)

3/8" 油底殼螺絲套筒組 (15 PCS)

Specifications:

- ◆ 8 mm HEX-BMW (BA), FORD (GB), GM (BA, GB)
- 9 mm HEX-GENERAL MOTORS (BA)
- 9.5 mm (3/8") HEX-BLMC (MORRIS) (BA), LANCIA BETA (DIFF)
- 10 mm HEX-FORD (GB)
- 12 mm HEX-FIAT LANCIA (GB,SU), PEUGEOT TALBOT (GB,SU)
- 14 mm HEX-LANCIA (GB,SU), MERCEDES (BA,GB)
- 17 mm HEX-LANCIA, AUDI (GB), AUSTIN (GB), BMW (GB), VW (GB)
- 8 mm (5/16") CITROEN (GB,SU), PEUGEOT (BA,GB,SU), RENAULT (SU), TALBOT (GB,SU), VOLVO(SU)
- 9.5 mm (3/8") HONDA (GB,SU), MAZDA (BA,GB), PEUGEOT (GB,SU), SAAB (GB), VOLVO (BA,SU)
- 11 mm FORD (BA,GB)
- 12 mm TOYOTA
- 13 mm NISSAN (BA,GB),SUBARU (BA)
- 10 mm BMW, FORD RENAULT TOYOTA
- ▲ 3/8" RENAULT



H.C.B-A2295

NEW

AIR BAG TOOL(4 PCS)

安全氣囊工具 (4 PCS)

- Dr. 1/4" x 85 mm long
- Sizes: 3 x Star Tamperproof T25/T27/T30, 1 x Hex bit 5 mm torx*
- Materia: Chrome Vanadium, bits from S2 steel
- The tool kit is used to remove and replace the airbag fixings accurately and securely on a wide range of vehicles.
- Application: Audi/Volkswagen/BMW/Mercedes-Benz/Vauxhall/Opel



H.C.B-A2296

NEW

HOSE CLAMP PLIER (0-38 mm)

水管夾線鉗 (0-38 mm)

- Size: 0-38 mm jaws x 240 mm long
- The jaw is made from Chrome Molybdenum - handle Carbon Steel, and it also has Nickel plated finish & electro deposited coating.
- Suitable for a variety of ring type or flat band hose clips/clamps
- The jaws have a special waffle shape which can securely reach, grab, remove or lock the hose clamp in place.
- This hose clip pliers has solved the problem of being used on all sizes of spring-type hose clips and clamps. They have a lattice-shaped tooth design that lets them grip the tangs of the clamp securely at any angle — even from the margin.
- The patented design includes a ratchet mechanism which is used to lock the clamp in place when it is removed, this protects the hose or induction pipe from being crushed by the clamp and makes it much easier to refit the clamp. The slim design is ideal for narrow spaces and both of the carbon steel handles and chrome molybdenum steel jaws make this patented plier have extra force to pull the stubborn clips.



H.C.B-B2296

NEW

HOSE CLAMP PLIER (22-55 mm)

水管夾線鉗 (22-55 mm)

- Hose clamp pliers 22-55 mm
- Length of jaws: 22-55 m x 240 mm
- Jaw is made from Chrome Molybdenum - handle Carbon Steel, and it also has Nickel plated finish & electro deposited coating.
- Suitable for a variety of ring type or flat band hose clips/clamps
- The jaws have a special waffle shape which can securely reach, grab, remove or lock the hose clamp in place.
- Patented product.



H.C.B-A2307

NEW

RATCHET EXHAUST PIPE CUTTER

排氣管切管器

- Universal application pipe cutter designed for where access is restricted.
- Ratchet mechanism allows cutting without having to rotate the tool completely around the tubing.
- Suitable for the toughest materials including stainless steel exhaust pipes.
- Contents: 1-1/8" - 2-9/16" → 31 - 65 mm
thickness ≤ 3 mm





010

HWANG CHERNG BIN
Specialty Tools Inc.

一
般
修
護
工
具
變
速
箱

GENERAL TRANSMISSION REPAIR TOOL



H.C.B-A1009 AUTOMATIC TRANSMISSION CLUTCH SPRING COMPRESSOR

自動變速箱離合器壓板拆裝工具

- For removing and installing the transmission rear clutch piston snap ring.
- This tool is adjustable and suitable for most models of American cars and light trucks.



H.C.B-B1010

TOYOTA/LEXUS AUTOMATIC TRANSMISSION CLUTCH SPRING COMPRESSOR

TOYOTA/LEXUS 自動變速箱離合器壓板拆裝工具

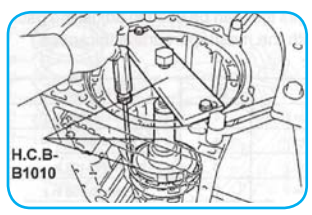

H.C.B-C1010

TOYOTA/LEXUS AUTOAMTIC TRANSMISSION CLUTCH SPRING COMPRESSOR (FOUR TEETH)

TOYOTA/LEXUS 自動變速箱離合器壓板拆裝工具 (4 齒)

- Conjunction with B1010.
- Application: TOYATA, LEXUS.



H.C.B-A1097-5 TOYOTA LEXUS TRANSMISSION HOLDING BASE

TOYOTA LEXUS 變速箱拆裝架

- Transmission fixing base sub-assy which can turn the transmission 360° for dismantling and assembling the transmission in different angles.
- Accessory: C type fixed base × 1, slide fixed lever (adjustable to different size of transmission) × 4 sets, screw × 4 pcs.
- Notice: Conjunction with any K/ D rack of the three: H.C.B-A1097, H.C.B-A1117, H.C.B-A1157.
- Application: Front wheel drive car , such as TOYOTA, LEXUS....., etc.

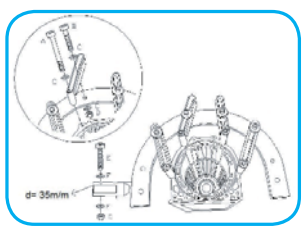

H.C.B-A2009 CLUTCH ALIGNMENT TOOL (IRON)

離合器對孔校正器 (鐵)

- Align single disc clutches on most of vehicles, light trucks & tractors. Properly aligns clutch plate by tapered cone fitting into pilot bushing or bearing.
- Size of 8 collects: from 0.456" (11 mm) to 0.980" (24.9 mm).
- N.W.: 0.7 KGS
- 可校正大部份汽車、輕型卡車和拖車上的單碟離合器。將圓錐伸入導向鐵套或培林中，即可校正離合器盤。
- 接頭尺寸：0.465"-0.98" (11mm-24.9mm)
- 淨重：0.7公斤





H.C.B-A1015 BLIND HOLE BEARING PULLER

隱蔽型培林拔卸組

5 / 17.2 / 18 / 1.64'

- This kit contains one slide hammer and 4 clamps.
- Clamps' dimensions:
 - ① 3/8" to 1/2" (10~14 mm)
 - ② 9/16" to 11/16" (15~19 mm)
 - ③ 5/8" to 1" (18~25 mm)
 - ④ 1" to 1-1/4" (25~32 mm) ID bearings' pulling.
- Turn the handle clockwise to open the front end of clamps to snug against the bearing for pulling out evenly without damaging the parts.
- 本組工具包含一支滑錘和四支螺桿拔取爪。
- 螺桿拔取爪尺寸：
 1. 3/8" - 1/2" (10-14 mm)
 2. 9/16" - 11/16" (15-19 mm)
 3. 5/8" - 1" (18-25 mm)
 4. 1" - 1-1/4" (25-32 mm)
- 順時針方向轉動手把、張開螺桿拔取爪直到貼合培林的內側，以拔出培林。不會損壞相關零件。



H.C.B-A1015-1	3/8" to 1/2" SAE (10-14mm)	For sedan
H.C.B-A1015-2	9/16" to 11/16" SAE (15-19mm)	For sedan
H.C.B-A1015-3	5/8" to 1" SAE (18-25mm)	For truck
H.C.B-A1015-4	1" to 1-1/4" SAE (25-32mm)	For truck

H.C.B-A2115 BLIND HOLE BEARING PULLER

隱蔽型培林拔卸組

- Applicable to automobiles, motorcycles, and machine repairing. It is convenient and easy to use.
- Both slide hammer-type bearing puller and two-leg universal puller are capable of removing the bearings.
- It is the best tool to use on manual transmission blind hole flywheel bearing. For example, TOYOTA, FORD....., etc
- H.C.B-A2115-9-3 can be used for removing the log pin installed on motorcycles.

Ref	Range
H.C.B-A2115-1	min ~ max 8mm~11m
H.C.B-A2115-2	min ~ max 12mm~17mm
H.C.B-A2115-3	min ~ max 18mm~23mm
H.C.B-A2115-4	min ~ max 24mm~29mm
H.C.B-A2115-5	min ~ max 30mm~34mm
H.C.B-A2115-9-1	A size M10*1.5P B size
H.C.B-A2115-9-2	A size M10*1.5P B size M8*1.25P
H.C.B-A2115-9-3	A size M10*1.5P B size M6*1.0P

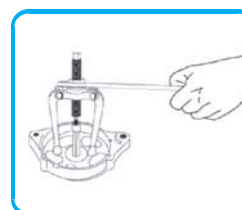
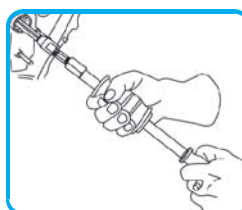
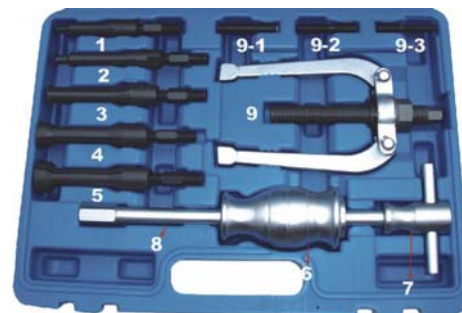



010
HWANG CHERNG BIN
 Specialty Tools Inc.

一般修護工具 變速箱
 General Transmission Repair Tool

General Transmission

H.C.B-A2013 TRANSMISSION FLOOR JACK (1 TON)

臥式變速箱千斤頂 (1 噸)

1 / 60 / 63.8 / 3.81'

- Designed ideally for removing and installing automobile and light truck transmission or differential.
- Universal saddle, brackets and chain sling are fully adjustable to accommodate transmission, clutches and differential in varying size.
- Safety overload system and safety by-pass system prevent damage to cylinder.
- Flash chromed ram inhibits rust from entering the hydraulic system.
- Four swivel caster wheels allow for easy position.
- Low frame passes undercarriage obstacles easily.
- Sensitive releasing valve helps to lower the load.
- 可用來移除和安裝汽車及輕型卡車的變速箱或差速器的理想設計。
- 萬用的托架、支撐座和吊鏈可調整，用於各種尺寸的變速箱、離合器和差速器。
- 防超載、防傾倒系統，可避免損壞油壓缸。
- 亮面的鍍鉻油壓缸，可以預防夾帶灰塵進入油壓系統中。
- 四個可轉動的腳輪，方便推動。
- 低底座可輕易地通過汽車底盤下的障礙物。
- 感應式洩壓閥可讓載重後的千斤頂放得更低。



H.C.B-A2035 HIGH POWER DOUBLE PISTON TRANSMISSION JACK

雙活塞變速箱千斤頂

- Transmission jack with double pistons that can provide 2 times faster rising speed.
- The load is up to 500 KGS.
- Specification:

Model	Capacity	Low	High	Base Size
H.C.B-A2035	500 KGS	870 mm	1800 mm	670 x 870 mm
N.W.	G.W.	Forward	Back	Side
56.5 KGS	60 KGS	24°	19°	± 20 mm



H.C.B-A2159 AIR ASSISTED HIGH LIFT TRANSMISSION JACK

氣壓式變速箱千斤頂

1 / 63 / 65 / 3.9'

- The high lift transmission jack is designed for the installation and removal of automobile transmissions.
- Specification:

Model	Capacity	PSI	Low Height	High Height
H.C.B-A2159	454 kgs (1000 lbs.)	90	939.8 mm	1905 mm
Base Size	Forward Tilt	Back Tilt	Left Tilt	Right Tilt
850.9 x 635 mm	42°	46°	12°	12°





H.C.B-A2012

VERTICAL TRANSMISSION JACK

立式變速箱千斤頂

1 / 58 / 59.5 / 3.34'

- A professional hydraulic transmission jack for removing and installing transmissions and axles on sedans, vans and light trucks.



H.C.B-A2185

DOUBLE PISTON TRANSMISSION JACK (5 FEET) PAT. D134321

雙活塞變速箱千斤頂 (5 腳)

- Transmission jack with double pistons that can provide rising speed twice as fast than traditional jack.
- With high standard safety design for five feet, when the transmission jack is moved.
- The load is up to 500 kgs.

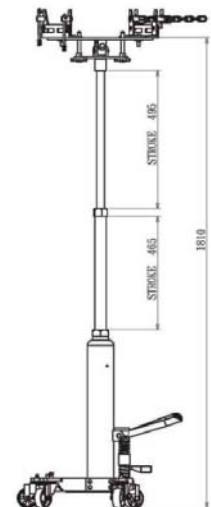
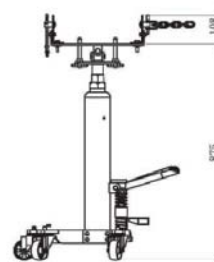
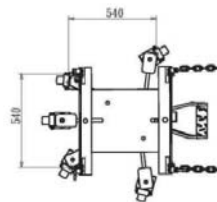

■ Specification:

Model	Capacity	Low	High	Base size
H.C.B-A2185	500 KGS	875 mm	1810 mm	540 x 540 mm (5 feet)
N.W.	G.W.	Forward Tilt	Back Tilt	Side
56 KGS	59 KGS	24°	19°	± 20 mm



010
HWANG CHERNG BIN
 Specialty Tools Inc.

一般修護工具 變速箱
 General Transmission Repair Tool

General Transmission

H.C.B-B2009

UNIVERSAL CLUTCH ALIGNMENT TOOL KIT

通用離合器校正工具組

- For modern front wheel drive vehicles with or without pilot / spigot bearings with flywheel fitting diameters from 12 – 20 mm.
- This tool allows the user to quickly and easily align a clutch disc towards the clutch pressure plate. Required for vehicles which do not feature a pilot- /guide bearing in the crankshaft (mostly on front-wheel-drive vehicles having a transversely installed engine).
- This tool main advantage is that it includes parallel expanding supports in place of more traditional tapered fittings that are hard to keep locating.
- The vehicles equipped with late-model front wheel drives without pilot bear in flywheel.
 For clutch-hub $\varnothing 15- \varnothing 28$ mm
 Sleeve: $\varnothing 12, 14, 15, 16, 17, 18, 19, 20$ mm



H.C.B-A2272

MASTER CLUTCH ALIGNMENT RECTIFIER KIT (15 PCS)

離合器中心校正器 (15 PCS)

- Universal application.
- Available for manual passenger cars and small trucks. (below 3500 c.c.)
- Available for manual transmission system:
 Nearly all vehicles with single disc.
 Some vehicles with double disc.
- Not suitable for DSG (double clutch) system.
- FF small car has very limited space for alignment. Short spindle can fit in very small space.
- Size: 10, 12, 14, 15, 16, 17, 19, 25, 27, 30 mm



H.C.B-A2289

ANGLE TIP LOCK RING PLIERS

平口鋼圈鉗

- Spread snap lock rings pliers for brakes, transmissions, pedal shafts, clutch shafts & machine tools.
- Jaws have deep serrations on the outside of tip to help lock rings securely.
- Spreading: 3.5 ~ 28 mm.
- Total length: 225 mm.

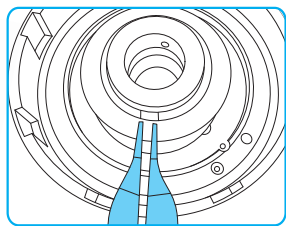

H.C.B-A1637

NEW

TRACTOR TRANSMISSION SECOND GEAR SERVICE TOOL

收割機變速箱二檔維修工具





010

HWANG CHERNG BIN
Specialty Tools Inc.

一
般
修
護
工
具
修
護
設
備

GENERAL REPAIR EQUIPMENT



H.C.B-B1022

TURNBUCKLE FOR SHOCK ABSORBER'S TOP LID

避震器上蓋鬆緊器



Description		Specification	Apply the type of car	
10.5 mm #01	10.5x3.5	VW Golf Rear Axle	[Diagram of car axle]	
12.5 mm #02	12.5x3.5	VW Polo Front Axle	[Diagram of car axle]	
14.5 mm #03	14.5x5	Polo, Golf, Passat, Audi 80	[Diagram of car axle]	
14.5 mm #04	14.5x3	Austin Maestro	[Diagram of car axle]	
14 mm #05	14x4	Mercedes Benz W203(C-class) W209(CLR)	[Diagram of car axle]	
14 mm #14	14mm	Honda, Nissan	[Diagram of car axle]	
16 mm #16	16mm	VW-Audi, Seat Fiat	[Diagram of car axle]	
17 mm #17	17mm	Ford, VW-Audi, Seat, Fiat	[Diagram of car axle]	
18 mm #18	18mm	Ford, VW-Audi, Seat, Rover, Fiat, Opel, Peugeot, Renault, Japanese Cars	[Diagram of car axle]	
19 mm #19	19mm	VW-Audi, Seat, Citroen, Fiat, Opel, Peugeot, Toyota	[Diagram of car axle]	
21 mm #21	21mm	Mercedes Benz(W203), Chrysler, VW-Audi, Japanese Cars, Ford	[Diagram of car axle]	
22 mm #22	22mm	VW-Audi, Seat, Citroen, Fiat, Opel, Peugeot, Renault, BMW	[Diagram of car axle]	
24 mm #24	24mm	VOLVO	[Diagram of car axle]	
27 mm #27	27mm	VW-Audi, Citroen, Peugeot	[Diagram of car axle]	
4 mm #34	4mm	Nissan	[Diagram of car axle]	
5.2 mm #35	5.2mm	VW-Audi, Nissan	[Diagram of car axle]	
6 mm #36	6mm	VW-Audi, Renault	[Diagram of car axle]	
6.3 mm #37	6.3mm	Nissan	[Diagram of car axle]	
7 mm #38	7mm	VW-Audi, Seat, Fiat	[Diagram of car axle]	
8 mm #39	8mm	Seat, Fiat	[Diagram of car axle]	
9 mm #40	9mm	Japanese Cars	[Diagram of car axle]	
10 mm #41	10mm	Seat, Fiat, Volvo	[Diagram of car axle]	
12 mm #42	12mm	Seat, Fiat	[Diagram of car axle]	
5mm"TD" #45	5mm	DS Nissan	[Diagram of car axle]	
10mm"TD" #50	10mm	Nissan, Ford	[Diagram of car axle]	
8 mm #55	8mm	Mercedes Benz	[Diagram of car axle]	
9mm #59	9mm	Opel Nashua, Chrysler	[Diagram of car axle]	
10mm #60	10mm	Chrysler, Ford & Bit holder	[Diagram of car axle]	
11mm #61	11mm	Japanese Cars	[Diagram of car axle]	
5mm #65	5mm	Honda	[Diagram of car axle]	
6mm #66	6mm	Seat, Fiat, Citroen, Peugeot, Ford, Opel, Renault, Jap car, BMW	[Diagram of car axle]	
7mm #67	7mm	VW-Audi, Seat, Fiat, Citroen, Peugeot, Mercedes Benz(W203), Renault	[Diagram of car axle]	
8mm #68	8mm	Mercedes Benz	[Diagram of car axle]	
3mm #73	3mm	Mercedes Benz, Opel Renault	[Diagram of car axle]	
3.5mm #74	3.5mm	Chrysler, Fiat, Citroen, Peugeot	[Diagram of car axle]	
4mm #75	4mm	Citroen, Peugeot	[Diagram of car axle]	
XZN-M12 #81	M12	Opel/Vauxhall	[Diagram of car axle]	
T60 #82	T60	Ford	[Diagram of car axle]	
T50 #83	T50	Nissan, Ford	[Diagram of car axle]	

H.C.B-A1051-1

PUNCHED BOARD (885 mm x 870 mm)

洞洞板 (3 尺 X 3 尺)

- The board is designed to hang up the tools.
- Specification: 885 mm x 870 mm
- N.W: 11 KGS, G.W: 12.3 KGS
- 特別設計來吊掛工具
- 規格：885 mm x 870 mm
- 淨重：11 公斤 毛重：12.3 公斤

■ Delivery without tools



H.C.B-A1051-2

PUNCHED BOARD (L1800 mm x W865 mm x H20 mm)

洞洞板 (長 1800 mm x 寬 865 mm x 高 20 mm)

- The board is designed to hang up the tools.
- Specification: L1800 mm x W865 mm x H20 mm
- N.W: 26 KGS, G.W: 29 KGS
- 特別設計來吊掛工具
- 規格：長1800 mm x 寬865 mm x 高20 mm
- 淨重：26公斤 毛重：29公斤

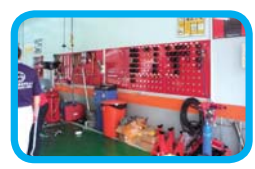
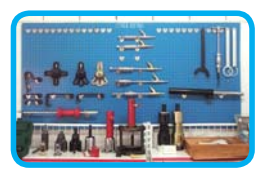
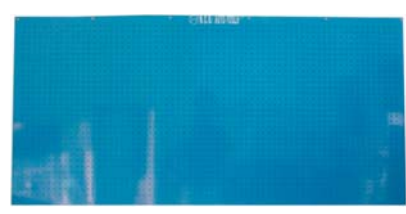



010
HWANG CHERNG BIN
Specialty Tools Inc.

SINCE 1990

General Repair
Equipment



H.C.B-A1051-3

3" FIXED HOOK

3" 洞洞勾



H.C.B-A1051-4

PUNCHED BOARD (561 mm x 866 mm x 20 mm)

洞洞板 (561 mm x 866 mm x 20 mm)

- The board is designed to hang up the tools.
- Specification: L 561 mm x W 866 mm x H 20 mm
- N.W: 5.21 KGS

- 特別設計來吊掛工具
- 規格：長561mm x 寬866mm x 高20mm
- 淨重：5.21公斤



H.C.B-A1065

WAGON SUPPORTER

貨車專用安全頂架 (配合平板頂車機使用)



H.C.B-A1124

FAN CLUTCH OIL

風扇離合器專用油



(1) Remove the fan clutch first and clean it.
先將風扇離合器拆下清洗乾淨



(2) Drill two small holes diameter about 2.5mm as photo.
於離合器對角線各鑽一個直徑約2.5mm的小孔



(3) Fill with the fan clutch oil.
將專用油注滿

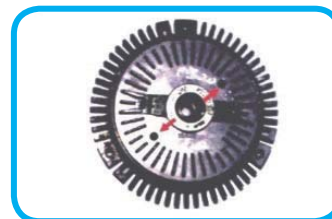

(4) At last, seal the small holes by screws.
將小孔用螺絲封閉即可

H.C.B-A1135-R

THE COMPACT TOOLBOX TROLLEY (RED)

美式工具車 (紅)

- Length: 490 mm, Width: 764 mm, Height: 1020 mm
- N.W: 55 KGS, G.W: 60 KGS
- 尺寸 : 490(長) x 764(寬) x 1020(高)mm
- 淨重 : 55公斤 毛重 : 60公斤



H.C.B-A1073

3 - SHELF SERVICE CART (STAINLESS)

三層不銹鋼工具車

- Thickness: 1.5 mm
- Size: 1050 x 400 x 780 mm
- The open-type tool cart for placing repair tools.
- 厚度 : 1.5 mm
- 尺寸 : 1050 x 400 x 780 mm
- 開放式的工具車



H.C.B-C1076

11 - DRAWER ROLLER CABINET

11 抽工具車

- Product Dimension:
 - OVERALL : 660 mm (W) x 307 mm (D) x 374 mm (H)
 - 3 DRAWERS : 170 mm (W) x 275 mm (D) x 50 mm (H)
 - 2 DRAWERS : 569 mm (W) x 275 mm (D) x 50 mm (H)
 - 1 DRAWER : 569 mm (W) x 275 mm (D) x 75 mm (H)
 - N.W. : 25.4 KGS G.W. : 28.4 KGS CUFT : 3.97'
 - Top - : 660 mm (W) x 307 mm (D) x 251 mm (H)
 - 2 DRAWERS : 569 mm (W) x 275 mm (D) x 50 mm (H)
 - 1 DRAWER : 569 mm (W) x 275 mm (D) x 75 mm (H)
 - N.W. : 13 KGS G.W. : 15.5 KGS CUFT : 2.7'
- Bottom - : 670 mm (W) x 460 mm (D) x 812 mm (H)
- OVERALL WITH 5" CASTERS :
 - 670 mm (W) x 460 mm (D) x 960 mm (H)
 - 5 DRAWERS : 576 mm (W) x 380 mm (D) x 75 mm (H)
 - 2 DRAWERS : 576 mm (W) x 380 mm (D) x 154 mm (H)
 - N.W. : 64 KGS G.W.:72 KGS CUFT : 12.24'





H.C.B-A2010 4 - SHELF CART

工具車 (4 層開放式附間隔塊)

- The open tool cart to place repair tools.
- Specification: W 550 mm x D 480 mm x H 900 mm
- 開放式的工具車
- 尺寸：550(長) x 480(寬) x 900(高) mm



H.C.B-A2011 TOOL BOX, 6 DRAWERS (MODEL 300)

6 抽工具車 (300 型)

- This cabinet's drawers are equipped with ball bearing slides to increase the load.
- Quick release design ball bearing drawers can be easily removed for replacement.
- Specification: W 560 mm x D 460 mm x H 910 mm
- 配備滾珠培林抽屜的鐵櫃，可提高耐重量。
- 滾珠培林式的抽屜，方便將整個抽屜取出。
- 尺寸：560(長) x 460(寬) x 910(高) mm



H.C.B-A2049 PROFESSIONAL TOOL BOX (7 DRAWERS)

7 層工具車

1 / 67 / 72 / 20.1'

- Specification: W 860 mm x D 480 mm x H 1030 mm



H.C.B-A2049-1

220 PCS COMBINATION TOOL KIT

220 件工具組

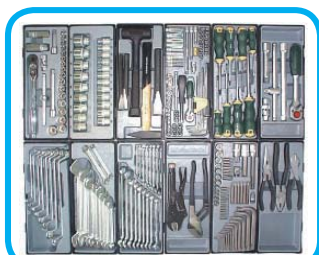

H.C.B-A2049-2

245 PCS COMBINATION TOOL KIT

245 件工具組





010
HWANG CHERNG BIN
Specialty Tools Inc.

一般修護工具 修護設備
General Repair Equipment

H.C.B-A2060 TOOL BOX, 7-DRAWER ROLLER CART (BALL BEARING SLIDE)

7 抽工具車

H.C.B-B2060 WALL CABINET (W: 660 mm x D: 305 mm x H: 600 mm)

工具壁櫃 (W: 660 mm x D: 305 mm x H: 600 mm)

H.C.B-C2060 TOP TRAY

上方膠盤

H.C.B-D2060 (18") SIDE PANEL

(18") 側板



H.C.B-A2060
TOOL BOX, 7 DRAWERS ROLLER CART (BALL BEARING SLIDE)
7 抽工具車

Size (WxDxH): 26.3" x 18" x 32"
(670 x 460 x 813 mm)
尺寸: 670 mm(寬) x 460 mm(深) x 813 mm(高)



H.C.B-C2060
TOP TRAY
上方膠盤

Turn the top of your A2060 series roll cabinet into a work/storage bench with one of these heavy duty tray tops. Also protects the top of your roll cabinet. Features include: sturdy handles, a large tray area, screwdriver slots, front & side storage wells.
此膠盤放置壁櫃的上方，可保護壁櫃上方避免撞擊，並多出可利用空間。
特點：有堅固的手柄與大托盤，前方與側邊有凹槽可以擺放個人平常使用的小工具，使工具不易滑落。

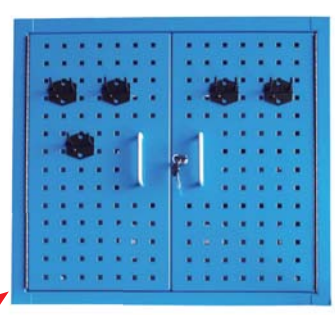
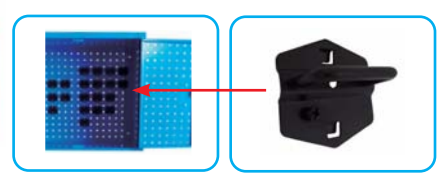

H.C.B-B2060
WALL CABINET
工具壁櫃

Size (WxDxH): 660 mm x 305 mm x 600 mm
尺寸: 寬: 660 mm x 深: 305 mm x 高: 600 mm



H.C.B-D2060
(18")SIDE PANEL
(18") 側板

■ A2060 系列工具車方便收納，其特點包括：堅固的手柄，一個大托盤區，螺絲刀槽，壁櫃可以吊掛工具及側邊可以吊掛擦手紙。

General Repair Equipment



H.C.B-E2060

14-DRAWER ROLLER TOOL CABINETS

14 抽滾輪工具櫃

- This sturdy tool storage cabinet consists of heavy duty ball bearing slides on all its drawers for smooth action. Features include key-locking drawers and 14,600 cu. in. of storage.
- This tool storage cabinet includes four casters to easily move your tools around the shop making it the ideal tool storage cabinet for any garage or shop!



H.C.B-F2060

NEW

3-DRAWER DOUBLE SIDED TROLLEY

3 抽雙開工具車

- This trolley is equipped with the laptop panel which can place the laptop on and helps do diagnosis service or software tuning.
- Double sided design makes it more convenient to take out the tools.
- Dimensions:
Overall: 765 mm (W) × 490 mm (D) × 948 mm (H)
Overall plus the 4" casters:
765 mm (W) × 490 mm (D) × 1050 mm (H)
1 drawer: 576 mm (W) × 415 mm (D) × 75 mm (H)
2 drawers: 576 mm (W) × 415 mm (D) × 154 mm (H)



H.C.B-A2001

3-SHELF SERVICE CART

3 層工具車

1 / 21.5 / 23.5 / 4.3'

- For garage, office, warehous service.
- Two or three strudy 2" deep trays with red enamel pain.
- 4 large 3" swivel casters and two with brakes device.
- It is coming with 1 piece of tools holder.
- Capacity: 150 KGS
- Specification: W 750 mm x D 440 mm x H 960 mm

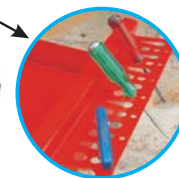

■ Delivery without tools

- 適用於修車廠、辦公室和倉庫。
- 3層紅色烤漆2吋深的托盤。
- 4個3吋腳輪，其中2個附有煞車。
- 方便組裝與使用。
- 配備有工具架。
- 載重：150公斤
- 尺寸：750(長) x 440(寬) x 960(高)mm



H.C.B-A2004 8 PCS SPECIAL SOCKET KIT

8 PCS 有齒特殊套筒組 (拆天線 . 後視鏡)

- Special socket for antenna nuts, radio trim nuts, remote control mirror adjustment lever and ball joint sleeve.
- This set services vehicles of FORD, VW, GM, NISSAN, GMC, MITSUBISHI, CHRYSLER, MAZDA and TOYOTA.
- N.W.: 0.6 KGS



H.C.B-B1117 GEAR TYPE UNIVERSAL K/D RACK PAT. M 252610 USA PAT. 7093809

專利齒輪式多功能拆裝器

- Application: V6, V8, V10, V12 and general engines.
- Technical information:
 1. With two strong support frames, make it stable while rotating engine.
 2. By manual turning rotating wheel, you can adjust the distance between two frames. Save time and labor!
 3. It can be rotated to any angle by using universal joint, applicable to any kind of engines.
 4. Capacity: 500 KGS

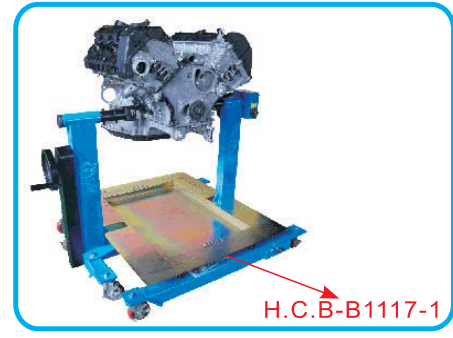

H.C.B-B1117-1

H.C.B-B1117-1 DRAIN PAN

廢油盤

- Height: 50 mm

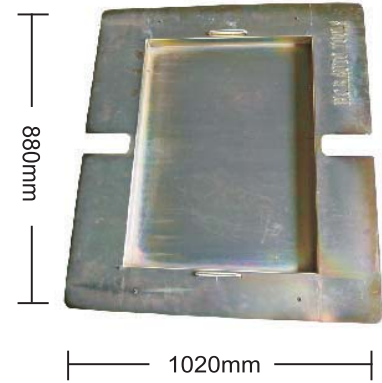



H.C.B-A1117

GEAR TYPE UNIVERSAL K/D RACK PAT. M 252610 USA PAT. 7093809

專利齒輪式多功能拆裝器

- The gear type universal K/D rack is designed for engine maintenance only.
- The gear type universal K/D rack can be removed and be replaced with H.C.B A-1117-4 C-type holding base for transmission maintenance if necessary.
- The gear and engine can be pivoted from 360 degrees during operation. Whenever the gear turning around, the engine will be rotated passively at the same time.
- The K/D rack is time, money, and labor saver.
- The K/D rack can be folded for storage.

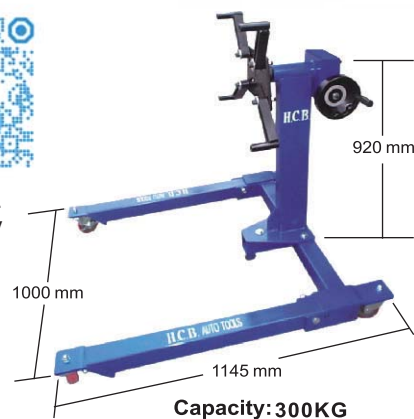

Caution:

Please kindly do not use any hammer or tools to knock the activated pin before you use. The accurate method of operation is to softly press the pin head and gently move it out.



Easy to store

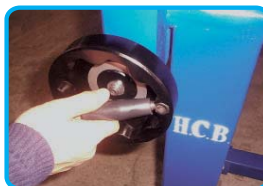

Hand wheel



H.C.B-A1117-1

MAGNETIC TRAY

長方形吸盤



H.C.B-A1117-2

DRAIN PAN

廢油盤

- Length: 1020 mm,
Width: 1010 mm,
Height: 110 mm,
Thickness: 2 mm

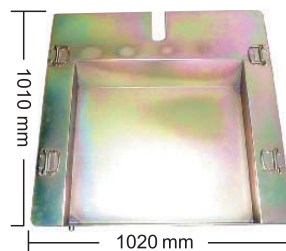

H.C.B-A1117-3

MAGNETIC LADDER TYPE T WRENCH FIXING BASE

T 桿階梯固定座





010
HWANG CHERNG BIN
 Specialty Tools Inc.

一般修護工具 修護設備
 General Repair Equipment

H.C.B-A1117-4 500 C-TYPE TRANSMISSION HOLDING BASE
 PAT. M 270936 USA PAT. 7093809

500 C 型變速箱固定座

- This tool is combines with H.C.B-A1117 or H.C.B-A1097 that are designed to turning 360° when repairing transmission. This tool can help extract or install any parts of transmission in different angles. It is really convenient and useful.
- Length : 500 mm



H.C.B-A1117-4-1 MITSUBISHI VIRAGE 1800 c.c. TRANSMISSION TOOL FITMENT

MITSUBISHI VIRAGE 1.8 變速箱工具配件

- This tool must be combined with H.C.B-A1117-4.



H.C.B-A1117-4-2 MITSUBISHI FREECA TRANSMISSION TOOL FITMENT

MITSUBISHI FREECA 變速箱工具配件

- This tool must be combined with H.C.B-A1117-4.



H.C.B-A1117-4-3 AUDI TRANSMISSION TOOL FITMENT

AUDI 變速箱工具配件

- This tool must be combined with H.C.B-A1117-4.
- Application: AUDI A3, A4, 1.8T TURBO, A6 1.8T



General Repair
 Equipment



H.C.B-A1117-5

600 TRANSMISSION HOLDING BASE TW PAT. USA PAT. PEN

600 ㄇ 型變速箱固定座

- This tool is combines with H.C.B-A1117 or H.C.B-A1097 that are designed to turning 360° when repair transmission. This tool can help extract or install any parts of transmission in different angles. It is really convenient and useful.
- Length : 600 mm



H.C.B-A1117-5-1

MITSUBISHI MG TRANSMISSION TOOL FITMENT

MITSUBISHI MG 變速箱工具配件

- This tool must be combined with H.C.B-A1117-5.



H.C.B-A1117-5-2

MITSUBISHI 6-SPEED TRANSMISSION TOOL FITMENT

MITSUBISHI 6 速變速箱工具配件

- This tool must be combined with H.C.B-A1117-5.
- Application: MITSUBISHI GOBAL LANCER GLXi, GOBAL LANCER Exi, GOBAL LANCER Sei/ EXi, VIRAGE iO

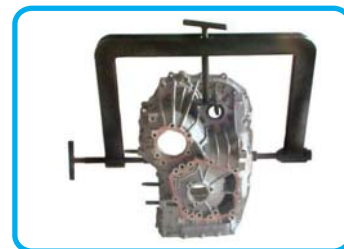

H.C.B-A1117-6

NEW

VIRAGE TRANSMISSION TOOL

VIRAGE 變速箱拆裝工具



H.C.B-B2015 CAR WASHER (3HP/220V)

高級進口洗車機 (3HP/ 220V)

- 9L/ min
- 155 bar Max pressure
- 2.7 KW Power
- 2800 R.P.M.
- 17-18 KGS
- An electrical cold water high pressure cleaner. B2015 has a three-piston axial pump, flanged directly to the electric motor, and a brass pump head and detergent suction from its 1.8 ltr internal tank.
- The total stop device is standard on all models. Motor is guaranteed to start in all conditions thanks to the easy-start mechanism. It also has an amperometric motor protector with manual restart.



H.C.B-A2019 3 TONS FOUR WHEELS HYDRAULIC FLOOR JACK

3 噸油壓 4 輪千斤頂

1 / 69 / 74 / 4.9'

- Features :
 1. Ideally suitable for all automotive, agricultural and light truck repair facilities.
 2. Mobile "T" handle and two mobile foot pedals can speed up for loading.
 3. "T" handle can be locked in the position of the three specific angles to lower load and easy maneuvering.
 4. Extra long chassis can reach any position under the vehicle.
 5. Hydraulic power unit with dust seals to prevent oil contamination.
 6. Large and heavy-duty near swivel caster wheels to provide easy maneuvering and positioning of jack.
- Capacity: 3 tons
- 產品特色 :
 1. 適用於所有的汽車、農機和輕型卡車的維修。
 2. 活動式的T型把手和兩個活動式踏板，可加速裝載。
 3. T型把手可以固定在三個特殊的角度，用來放低重心、方便移動。
 4. 加長的底座可以深入車底。
 5. 油壓系統加防塵油封，可預防油污。
 6. 大型耐重的旋轉輪輪，可防止傾倒和定位千斤頂。
- 載重：3噸

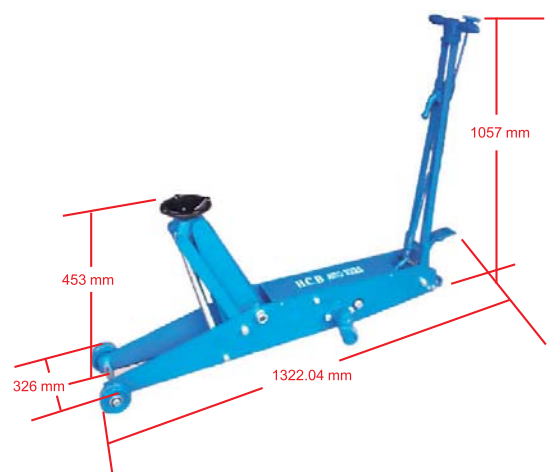

H.C.B-A2084 5 TONS FOUR WHEEL HYDRAULIC FLOOR JACK

5 噸 4 輪千斤頂

- Capacity: 5 tons





H.C.B-B2043

ALUMINIUM ALLOY FOUR WHEEL HYDRAULIC FLOOR JACK (FANCY TOOL) (2 TONS)

鋁合金 4 輪液壓千斤頂 (2 噸)

■ **Characteristic:**

Light weight- Only 19.5 KGS
High performance (Only 13 ½ pumps can reach 445 mm height)
Maximum capacity 2000 KGS.
Your best choice.

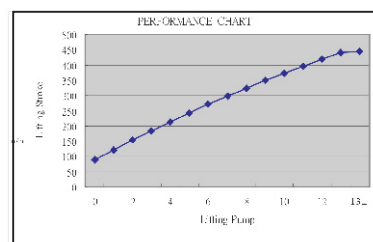
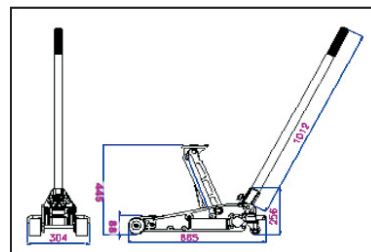

Stroke mm	88	120	152	183	213	242	272	298	325	349	373	396	418	440	445
Pump times	0	1	2	3	4	5	6	7	8	9	10	11	12	13	13½

Min Height	Max Height	Stroke	N.W.	G.W.	Lifting Pump	Lifting Capacity	CUFT
88 mm	445 mm	357 mm	19.5 KGS	21.5 KGS	13½ times	2000 KGS	2.2'

H.C.B-A2129

3 TONS JACK

3 噸千斤頂



JACK SIZE L*W*H	MIN HEIGHT	MAX HEIGHT	STROKE	HANDLE SIZE	LIFTING PUMP	LIFTING CAPACITY	N.W.
720*400*175	89 mm	518 mm	429 mm	1252 mm	11.5 STROKES	3 TON	47 kg

- Before operating, study, understand and follow all setup, operating and maintenance instructions that accompanied this device. Hazards such as dropping, tipping or slipping of load can happen if instructions are not followed. Failure to avoid hazards could cause accidents resulting in serious or fatal personal injury and/or property damage.
- Avoid hazards: ① Do not exceed rated capacity. ② Use only on a hard level surface. ③ Support vehicle with appropriate means immediately after lifting. ④ Lift only on areas of the vehicle as specified by the vehicle manufacturer. ⑤ Be sure setup is stable. ⑥ Do not move or dolly the vehicle while on the jack. ⑦ Do not alter or modify this device. ⑧ Do not use saddle adapters unless approved by HCB.



010
HWANG CHERNG BIN
 Specialty Tools Inc.

一般修護工具 修護設備
 General Repair Equipment

General Repair
 Equipment

H.C.B-A2020 SCREW DRIVER TOOL KIT (78 PCS)

星型、E 型起子綜合組 (78 PCS)

- You may never have to buy star tools again.
- This kit contains the most popular and complete sizes of screw driver packed with storage blow case.
- Specification:
 - 1pcs 1/2" drive ratchet (quick release)
 - 1pcs 1/4" drive ratchet
 - 2 bit holders 1/4"x1/4" hex & 1/2"x10 mm hex
 - 1 telescopic magnet & needle
 - 10pcs 1/4" drive bit sockets T7, 8, 9, 10, 15, 20, 25, 27, 30 & T40
 - 10 tamper proof bits 25mmx1/4 hex T7, 8, 9, 10, 15, 20, 25, 27, 30, T40
 - 7pcs 1/4" drive E sockets E4, 5, 6, 7, 8, 10, 11
 - 5 star bits 30mmx10mm hex T40 45 50 55 60
 - 9 star bits 75mmx10mm hex T15 20 25 30 40 45 50 55 and T60
 - 7pcs 1/2" drive sockets E12, 14, 16, 18, 20, 22, 24
 - 9 star screwdrivers T8, 9, 10, 15, 20, 27, 30, 40
 - 12 keys: T8, 10, 15, 20, 25, 27, 30, 40, 45, 50, 55, 60
 - 4 star wrenches E6x8, E10x12, E14x18, E20x24
- N.W.: 4.7 KGS



H.C.B-A2021 SOCKET TOOL KIT (34 PCS)

星型中空、E 型綜合套筒組 (34 PCS)

- Contents:
 - 5 pcs 1/4" Star-E socket: E4, E5, E6, E7, E8
 - 4 pcs 3/8" Star-E socket: E10, E12, E14, E16
 - 2 pcs 1/2" Star-E socket: E18, E20
 - 2 pcs 1/2" Torx bit socket: T55, T60
 - 4 pcs 3/8" Torx bit socket: T40, T45, T47, T50
 - 1 pcs 1/2" TAMPER. Torx bit socket: T55
 - 3 pcs 3/8" TAMPER. Torx bit socket: T40, T45, T50
 - 7 pcs 1/4" Torx bit socket: T8, T10, T15, T20, T25, T27, T30
 - 6 purchase 1/4" Tamper. Torx bit socket: T10, T15, T20, T25, T27, T30
- N.W.: 1.5 KGS



H.C.B-A2022 18 PCS IMPACT HEXAGON & TX-STAR WRENCH KIT

6 角、星型凸套筒組 (18 PCS)

- Specification / 規格 :
 - Hexgon / 六角 : H5, H6, H7, H8, H10, H12, H14, H17
 - TX-Star / 星形 : T30, T40, T45, T50, T55, T60, T70
 - Dr. 1/2 x 125 mm extension bar / 延長桿
 - Dr. 1/2 x 250 mm sliding T-handle / T 形扳手
 - Dr. 1/2 ratchet handle / 棘輪扳手
- Application: Most of cars / 適用大部分車輛
- N.W.: 3.3KG / 淨重 : 3.3 公斤





H.C.B-A2023 UNIVERSAL SOCKET TOOL KIT (12 PCS)

1/2" 中空全能套筒組 (12 PCS)

- 12 pcs socket tool for multi-function
- 1 pcs Go-thru gearless ratcheting handle
- 11 pcs sockets:
 - 1: 14 mm 6: 20 mm 11: 26 mm
 - 2: 15 mm 7: 21 mm 12: 22 mm x Dr. 1/2"
 - 3: 16 mm 8: 22 mm
 - 4: 17 mm 9: 23 mm
 - 5: 19 mm 10: 24 mm
- N.W.: 2.15 KGS



H.C.B-A2023-1 13 PCS 3/8" DRIVE GO-THRU SOCKET WRENCH KIT

13 PCS 3/8" 中空全能套筒組

- 1 pcs Go-thru gearless ratcheting.
- 1 pcs 16 mm to 3/8" drive standard socket adaptor
- 1 pcs universal joint
- 1 pcs dual purpose 16 mm spark plug socket also for 50 mm extension bar.
- 8 pcs Go-Thru sockets: 8, 10, 11, 13, 14, 16, 17, 19 mm



H.C.B-A2028 8 PCS MIRROR POLISHED COMBINATION WRENCH KIT (FINE-TOOTH, 72 TEETH)

8 PCS 開口止滑迴旋扳手組

- Allow to remove of 75% rounded of bolt & nut.
- Specification:
 - 1: 8 mm 5: 13 mm
 - 2: 10 mm 6: 14 mm
 - 3: 11 mm 7: 17 mm
 - 4: 12 mm 8: 19 mm

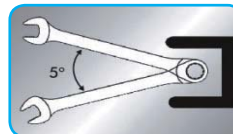
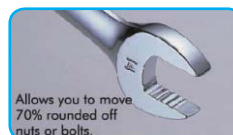

H.C.B-A2029 8 PCS PIN PUNCH KIT

8 PCS 平沖組

- The cylinder shank with ultra-fine tolerances is perfectly smooth to ensure a high degree to toughness.
- N.W.: 0.5 KGS



Item No.	Length
1	1.6 mm
2	2.3 mm
3	3.2 mm
4	4.0 mm
5	4.8 mm
6	5.5 mm
7	6.4 mm
8	8.0 mm

H.C.B-A2038

AUTOMOTIVE VACUUM TEST KIT

全配備真空吸力槍組

10 / 13 / 14.3 / 2.9'

- The use of a vacuum gauge is so often overlooked when determining mechanical condition and carrying out fault diagnosis on internal combustion engine.
- Monitoring actual manifold vacuum is invaluable when troubleshooting engine faults.
- This can only be done by using a good quality vacuum gauge and with this coupled to test vacuum pump; it allows static testing of all types of vacuum operated systems.
- Content:

1. Vacuum pump	6. 70mm container hose x 1 pc
2. Fluid container	7. Assorted vacuum hose fitting x 12 pcs
3. Transfer cap	8. Brake bleeder fittings x 3 pcs
4. 500mm pvc vacuum hoses x 2 pcs	9. Instruction manual x 1 pc
5. 100mm pvc vacuum hose x 1pc	10. Blow moulded case x 1 pc



H.C.B-B2038

AUTOMOTIVE VACUUM & PRESSURE TEST KIT

全配備正負壓槍

- Contain many kinds of joint to fit most kinds of vehicles.
- The body has a switch to control two kinds of pressure conditions.
- Include the parts of brake bleeder.
- Pressure range: positive pressure: 0~60 psi (1~4 inhg)
Negative pressure: 0~-30 psi (0~-1inhg)



H.C.B-A2024

9 PCS BALL-END HEX. KEY KIT

9 PCS 球型 6 角扳手組

- Work in hard to reach areas, faster inserting and removing, and full depth engagement.
- Specification:

1: 1.5 mm	6: 5 mm
2: 2 mm	7: 6 mm
3: 2.5 mm	8: 8 mm
4: 3 mm	9: 10 mm
5: 4 mm	
- N.W.: 0.48 KGS



H.C.B-A2039

FENDER COVERS (870 x 570 mm)

葉子板護套 (870 x 570 mm)

- Dimension: 870 x 570 mm
- Thickness: 1.2 mm



Heavy, long wearing vinyl protects the car.





010
HWANG CHERNG BIN
 Specialty Tools Inc.

General Repair
 Equipment



H.C.B-A2068

FENDER COVER (1050 mm x 650 mm)

葉子板護套 (1050 mm x 650 mm)

- Material : surface: non-woven materials; inside: sponge leather.
- Dimension : 1050 mm x 650 mm
- Thickness : 0.9 mm
- Freeze resistance : -15°C
- To keep vehicle away from grease and scratches.
- Wipe-clean leather-grained vinyl is grease resistant.
- Magnetic design helps the fender cover install and remove easily.
- Variety of colors are available.



H.C.B-B2068

NEW

UNIVERSAL FENDER COVERS (1500 mm x 860 mm)

葉子板護套 (1500 mm x 860 mm)

- Optimal protection for your customers' vehicles.
- Prevent from scratches, dents, oil and dirt.
- Save costs, time and nerves.
- Increase work quality – reduce refinishing works.
- Suitable for nearly all vehicle types.
- High-quality materials provide long service life.
- Dimensions: 1500 mm x 860 mm



H.C.B-A2051

DIODE FLEXIBLE LIGHT

二極體可彎燈

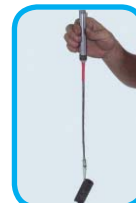

H.C.B-A2056

FLEXIBLE LED LIGHT

LED 照明燈

- Push on/ off button.
- 300 mm full flex shaft.



H.C.B-A2061 HEIGHTENED MANUAL HYDRAULIC PRESS (15 TONS)

加高型手動油壓床 (15 噸)

- Application: Used for wide range of mechanical parts like reformation of shaft bearing, gear, pressed in or extruded.
- It is a very useful tool for vehicle or industrial mechanical parts maintenance.
- Feature: High precision hydraulic press for industry.
- It is designed with double oil-cycle system.
- Press head assembly is movable to right and left sides.
- Press head and worktable are adjustable up and down for pressure process.
- A 600kg/cm² precision pressure gauge is included.
- N.W.: 160KGS. G.W.: 190KGS
- 適用範圍：大範圍的機械加工。例如：培林、齒輪加工成型。
- 車輛、工業零件維修的好工具。
- 高精密度的油壓。
- 雙油壓循環系統。
- 壓頭可向左、右轉動。
- 壓頭和工作檯都可以調整高低。
- 配備有精密的油壓表。(600公斤/公分²)
- 淨重：160公斤，毛重：190公斤



H.C.B-A2073 14 PCS HEXAGON & TX-STAR SOCKET BIT KIT

14 PCS 6 角 & 星型套筒組

- Dr. 1/2" x 55 mm length bit socket set.
- 7 pcs Tx-star: T30, T40, T45, T50, T55, T60, T70
- 7 pcs Hexagon: 5, 6, 7, 8, 10, 12, 14 mm
- #SAE: 7 pcs Hexagon 3/16, 1/4, 5/16, 3/8, 7/16, 1/2, 9/16



H.C.B-A2075 44 PCS PROFESSIONAL TX-STAR BIT & BITS KIT

44 PCS 專業星型起子組

- Specification
- 9 pcs 30 mm length tamper. TX-STAR bit: T20, T25, T27, T30, T40, T45, T50, T55, T60
- 9 pcs 75mm length TX-STAR bit: T20, T25, T27, T30, T40, T45, T50, T55, T60
- 7 pcs Hexagon bit: 4, 5, 6, 7, 8, 10, 12 mm
- 5 pcs spline bit: M5, M6, M8, M10, M12
- 2 pcs slotted bit: 8, 10 mm
- 3 pcs ppozidriv bit: PZ1, PZ2, PZ3
- 4 pcs Phillips bit: PH1, PH2, PH3, PH4
- 1 pcs 10mm HEX. Flexible ratchet handle
- 1 pcs 75mm length 3/8" SQ. x 10mm HEX. Extension bar
- 1 pcs 1/4" SQ. x 10mm HEX. Socket adapter
- 1 pcs 3/8" SQ. x 10mm HEX. Bit adapter
- 1 pcs 1/2" SQ. x 10mm HEX. Bit adapter



H.C.B-A2074 40 PCS PROFESSIONAL QUALITY MECHANICS BIT KIT

40 PCS 專業級機械套筒組

- Specification
- 30 mm & 75 mm length bit
- 14 pcs Hexagon bit: 4, 5, 6, 7, 8, 10, 12 mm
- 14 pcs TX-STAR bit: T20, T25, T30, T40, T45, T50, T55
- 10 pcs spline bit: M5, M6, M8, M10, M12
- 1 pcs 1/2" SQ. Dr.x 10mm bit adapter
- 1 pcs 3/8" SQ. Dr.x 10mm bit adapter





H.C.B-A2059

SIDE SLIP TESTER

雙輪定位側滑試驗機



- Length: 2370 mm Width: 580 mm Height: 115mm
- N.W.:174 KGS



Rapid assessment of the wheel geometry by measuring the lateral deviation (side slip) of one wheel in comparison with the other wheel.

POWER SWITCH



The sensor for revolving frequency

Adjustable to horizontal level

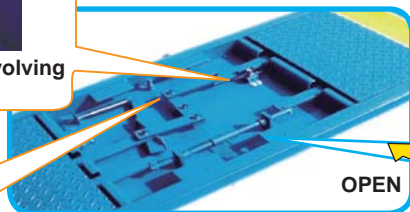

OPEN

CLOSE



SWITCH ON / OFF

H.C.B-B2059

COMPLETE IC DESIGNED TOEIN & TOEOUT TESTING

數控式偏滑測試錶



Connect the sensor with digital display



Power resource

H.C.B-A2059-1

SINGLE SIDE SLIP TESTER

單輪定位測滑試驗機

- Convenient for small space.
- To carry by hand.

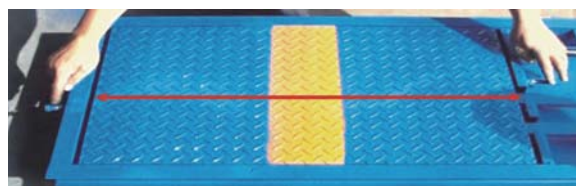

Adjustable to fit the both positions

H.C.B-C2059

SINGLE SIDE SLIP TESTER

單輪定位測滑試驗機

- A portable measuring gauge plate for trucks with 1 tons wheel load.
- Portable, ultra-flat design.
- Accurate readings.
- Scale with millimeter divisions.
- Use on any viable level ground.
- Low drive.
- Fast and reliable testing wheel alignment.
- Always operational.
- Easy to do fast and reliable wheel alignment testing.

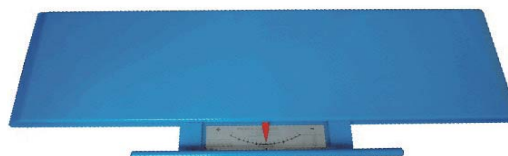

Wheel load max.	1 t
Length	950 mm
Width	385 mm
Depth	24 mm
Color	Blue
Weight	21 kg

H.C.B-A2050

CAST STEEL SWIVEL-BASE VISE (6")

老虎鉗 (6")

H.C.B-A2050-1

CAST STEEL SWIVEL-BASE VISE (8")

老虎鉗 (8")

H.C.B-A2050-2

CAST STEEL SWIVEL-BASE VISE (10")

老虎鉗 (10")

H.C.B-B2050

CAST IRON VISE (6")

老虎鉗 (6")



- 360° swivel base.
- Material: Cast steel.
- 360° 旋轉底座
- 材質：鑄鐵
- Material: High quality cast iron.
- 材質：高級鑄鐵

H.C.B-A2062

3/8" IMPACT SOCKET KIT (VOLUTE)

渦型衝擊套筒

- Straight rod: diameter 8 mm

■ Size:

Size	D1 (mm)	D2 (mm)	S (mm)	L (mm)
10			10	
11	14.5	17.5	11	32
12	17.5	19	12	32
13	22	20.4	13	32
14	22	21.5	14	32
15	22	22.5	15	32
16	22	24	16	32
17	25	25.8	17	32
19	27	27.8	19	34



H.C.B-B2062

TWIST SOCKET KIT (12 PCS)

螺旋式防脫套筒 (12 PCS)

■ Features:

1. This twist socket kit is specially designed for loosening a nut, which can not be done by a socket or wrench.
2. This tool is only useful for a nut with positive threads.
3. This tool can be used while a nut could not be loosened because of rust and deformation.
4. This socket set is made of AISI4340 with HRC 52-55 degree hardness.

■ Instruction:

Use on the damaged screws & nuts. Special spiral design for easier removal of the damaged screws.

■ Size:

- Dr. 3/8" 8, 10, 12, 13 mm (Length: 32 mm)
- Dr. 1/2" 14, 15, 16, 17, 19, 21 mm (Length: 34 mm)
- 2 pcs pin punches 8 mm x 74 L: 12 mm x 80 L



H.C.B-C2062

TWIST SOCKET 3/4" 27,30,32,33,34,36 mm + BAR

3/4" 外六角螺旋套筒 (7 PCS)

■ Material:

Socket: SCM440
Tonny bar: S45C

■ HRC:

Socket: 45-48 degree
Tonny bar: 38-43 degree

■ Size:

- 3/4" Dr-38L-27 mm-HEX
- 3/4" Dr-38L-30 mm-HEX
- 3/4" Dr-38L-32 mm-HEX
- 3/4" Dr-38L-33 mm-HEX
- 3/4" Dr-38L-34 mm-HEX
- 3/4" Dr-38L-36 mm-HEX
- A Tonny bar-80 mm (Ø12 mm)





H.C.B-A2076

12 PCS DEEP STAR-E SOCKET KIT

12 PCS 長 E 型套筒組

■ Specification:

- 6 pcs Dr. 1/4" socket: E4, E5, E6, E7, E8, E10
- 5 pcs Dr. 3/8" socket: E11, E12, E14, E16, E18
- 1 pcs Dr. 1/4" x 3/8" adapter



H.C.B-A2077

47 PCS BITS & SOCKET MULTI-TOOL KIT

47 PCS 起子、套筒複合工具組

- 12 pcs Dr.1/4" HEX. Socket: 4, 4.5, 5, 5.5, 6, 7, 8, 9, 10, 11, 12, 13 mm
- 8 pcs Hexagon bit: 2, 2.5, 3, 4, 5, 6, 7, 8 mm
- 7 pcs TX-STAR bit: T10, T15, T20, T25, T27, T30, T40
- 5 pcs soltted bit: 4, 4.5, 5.5, 6.5, 8 mm
- 4 pcs Philips bit: PH1, PH2, PH3, PH4
- 4 pcs pozidriv bit: PZ1, PZ2, PZ3, PZ4
- 1 pcs hammer wrench tool
- 1 pcs center punch
- 1 pcs 1/4" HEX. x Dr. 1/4" socket adapter
- 1 pcs 7/16" HEX. x Dr. 1/4" socket adapter
- 1 pcs Dr. 1/4" x 1/4" HEX. bit adapter
- 1 pcs 1/4" x 75 mm length magnetic bit holder
- 1 pcs 7/16" HEX. x 1/4" HEX. ratchet bit holder



H.C.B-A2078

7 PCS Dr. 1/2" TAMPER. TX-STAR BIT SOCKET KIT

7 PCS Dr. 1/2" 星型套筒組

- Size: T30H, T40H, T45H, T50H, T55H, T60H, T70H
- Length: 100 mm



H.C.B-A2081

MULTIPLE WINDOW SCALE DIGITAL ADJUSTABLE TORQUE WRENCHES WITH LIGHT (Dr. 3/8")

3/8" 扭力扳手

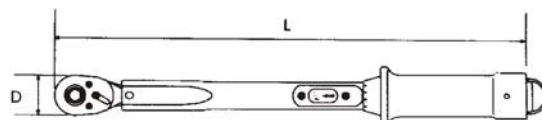

Model No.	Square driver	Gear Teeth	Increments (FT-LB)	Minimum Maximum				D	L	Head Depth
				FT-LB	NM	FT-LB	NM			
HCB-A2081	3/8"	32	10	20	20	80	110	36.5	403	18.5

H.C.B-B2081 3/8" DIGITAL TORQUE WRENCH W/ ANGLE HEAD (LENGTH: 400 mm)

3/8" 仰角式數位扭力扳手 (長度 : 400 mm)



Model No.	Driver Square	Teeth	Nm	Lbf-ft	Weight	Length
B2081	3/8"	48T	10-135	7.4-99.6	1.05kgs	40 mm

H.C.B-A2083 RIGHT HAND CLICK TYPE TORQUE WRENCH (Dr. 1/4")

1/4" 扭力扳手

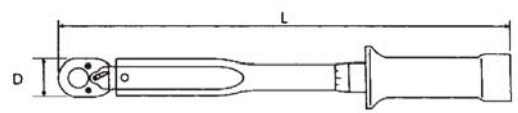

Model No.	Square driver	Gear Teeth	Increments (FT-LB)	Minimum Maximum		D	L	Head Depth
				FT-LB	FT-LB			
HCB-A2083	1/4"	24	5	20in-1b	200in-1b	26.0	284	11.2

H.C.B-A2082 MULTIPLE WINDOW SCALE DIGITAL ADJUSTABLE TORQUE WRENCHES WITH LIGHT (Dr. 1/2")

1/2" 扭力扳手

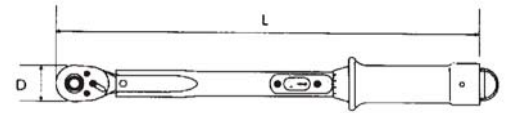

Model No.	Square driver	Gear Teeth	Increments (FT-LB)	Minimum Maximum				D	L	Head Depth
				FT-LB	NM	FT-LB	NM			
HCB-A2082	1/2"	32	10	50	50	250	350	36.5	625	18.5

H.C.B-B2082 MULTIPLE WINDOW SCALE DIGITAL ADJUSTABLE TORQUE WRENCHES WITH LIGHT (Dr. 1/2")

1/2" 扭力扳手

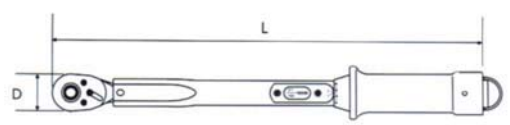

Model No.	Square driver	Gear Teeth	Increments (FT-LB)	Minimum Maximum				D	L	Head Depth
				FT-LB	NM	FT-LB	NM			
HCB-B2082	1/2"	32	10	20	20	80	110	36.5	403	18.5



H.C.B-C2082

1/2" DIGITAL TORQUE WRENCH W/ ANGLE HEAD (LENGTH: 570 mm)

1/2" 仰角式數位扭力扳手 (長度: 570 mm)



Model No.	Driver Square	Teeth	Nm	Lbf-ft	Weight	Length
C2082	1/2"	48T	20-200	14.8-147	1.6kgs	570 mm

H.C.B-A2086

160 PCS COMPREHENSIVE TOOL KIT

160 PCS 專業級套筒組

2 / 23.5 / 24.5 / 1.42'

■ **Specification:**

- 8-3/8" socket: 10, 13, 14, 15, 16, 17, 18, 19 mm
- 6-3/8" deep socket: 10, 11, 12, 13, 14, 15 mm
- 3-3/8" spark plug: 16, 18, 21 mm
- 8-3/8" star socket: 8, 10, 11, 12, 14, 16, 18, 20 mm
- 1-coupler 3/8" x 5/16"
- 1-3/8" ratchet handle
- 1-tm head 3/8"f x 1/2"m
- 1-adapter 3/8"f x 1/4"m
- 2-3/8" extension bar 3' & 10"
- 1-3/8" universal joint
- 1-3/8" bit adapter
- 10-1/2" socket: 17, 19, 20, 21, 22, 24, 27, 30, 32, 34mm
- 4-1/2" power socket: 17, 19, 21, 23mm
- 3-1/2" deep socket: 17, 19, 22mm
- 1-coupler 1/2" x 5/16"
- 1-1/2" ratchet handle
- 2-1/2" extension bar 5" & 10"
- 1-tm head 1/2"f x 3/8"m
- 1-adapter 1/2"f x 3/8"m
- 1-1/2" universal joint
- 34-5/16" bit
- 3-gear wrench: 8x10, 13x15, 17x19 mm
- 12-combination wrench:
- 8, 10, 11, 12, 13, 14, 15, 16, 17, 18, 19, 22 mm
- 11-hexkey: 1.5, 2, 2.5, 3, 4, 5, 6, 7, 8, 10 mm
- 2 set/23.5 kgs/24.5 kgs/1.42'



- 13-1/4" socket: 3.5, 4, 4.5, 5, 5.5, 6, 7, 8, 9, 10, 11, 12, 13 mm
- 5-1/4" deep socket: 5.5, 6, 7, 8, 9 mm
- 1-1/4" ratchet handle
- 1-1/4" spanner handle
- 1-1/4" bit adapter
- 2-1/4" extension bar 2" & 4"
- 1-1/4" sliding t-bar
- 1-1/4" universal joint
- 18-1/4" bit socket

H.C.B-A2103

Dr. 1/2" MULTI-SPLINE BIT SOCKET KIT (26 PCS)

1/2" 12 角星型綜合套筒組 (26 PCS)

- Material: Bit-S.2 steel; Socket-Cr-Van steel
- 8 pcs Length 55 mm: M5, M6, M8, M9, M10, M12, M14, M16
- 7 pcs Length 100 mm: M5, M6, M8, M9, M10, M12, M14
- 7 pcs Length 140 mm: M5, M6, M8, M9, M10, M12, M14
- 4 pcs Length 200 mm: M8, M10, M12, M14





010

HWANG CHERNG BIN
Specialty Tools Inc.

一般修護工具 修護設備

General Repair Equipment

General Repair
Equipment

H.C.B-A2104

Dr. 1/2" HEXAGON BIT SOCKET KIT (30 PCS)

1/2" 六角綜合套筒組 (30 PCS)

- Material: Bit-S.2 steel; Socket-Cr-Van steel
- 9 pcs Length 55 mm: 5,6,7,8,10,12,14,17,19 mm
- 8 pcs Length 100 mm: 5,6,7,8,10,11,12,13 mm
- 7 pcs Length 140 mm: 5,6,7,8,11,12,14 mm
- 6 pcs Length 200 mm: 5,6,7,8,10,12 mm



H.C.B-A2105

Dr. 1/2" TX-STAR BIT SOCKET KIT (32 PCS)

1/2" 六角星型綜合套筒組 (32 PCS)

- Material: Bit-S.2 steel; Socket-Cr-Van steel
- 10 pcs Length 55 mm: T20,T25,T27,T30,T40,T45, T50,T55,T60,T70
- 10 pcs Length 100 mm: T20,T25,T27,T30,T40,T45 ,T50,T55,T60,T70
- 6 pcs Length 140 mm: T40,T45,T50,T55,T60,T70
- 6 pcs Length 200 mm: T40,T45,T50,T55,T60,T70



H.C.B-A2106

Dr. 1/2" RIBE BIT SOCKET KIT (32 PCS)

1/2" 六角綜合套筒組 (32 PCS)

- Material: Bit-S.2 steel; Socket-Cr-Van steel
- 9 pcs Length 55 mm: M5, M6, M7, M8, M9, M10, M12, M13, M14
- 9 pcs Length 100 mm: M5, M6, M7, M8, M9, M10, M12, M13, M14
- 7 pcs Length 140 mm: 8, M9, M10, M12, M13, M14
- 7 pcs Length 200 mm: 8, M9, M10, M12, M13, M14
- For FIAT cylinder head bolts :
Ribe M6 - M7 - M8 (55 mm long)
Ribe M8 - M10 - M12 - M13 - M14 (140 mm long)
Ribe M6 - M8 - M10 (200 mm long)
- For VW and Audi cylinder head bolts :
Ribe M10 - M12 (100 mm long)
Ribe M9 - M10 (140 mm long)
Ribe M8 - M9 - M10 (200 mm long)
M12 x 140 mm for New Beetle, FORD, GM, MERCEDES-BENZ





H.C.B-C2195

ANGLE ADJUSTABLE 30PCS LED WORKING LIGHT W/ AC /DC RECHARGEABLE BATTERY

LED 工作燈 (附磁鐵)

- W: 1 pc of 3W high power LED light
- L: 4 pcs of LED light
- U: 1 pc of U.V light



W/U

L

360 SWIVEL HOOK

Unbreakable Acrylic lens

AC100-240V

DC 12V~24V

30pcs LED LIGHT

recharge light

on/off

High strength magnet

60°

Angle Adjustable

■ Specification:

- A.LED quantity: 30 pcs of LED with top light LED*4 or 3W LED*1 or U.V*1
- B.LI-ION rechargeable battery: 3.7V 2200MAH.
- C.Charger input: AC100 ~ 240V 50/60Hz /DC12V~24V
- D.Power output: 5.0V 1000mAH.
- E.Charger time: 3.5 ~ 4.0 hours.
- F.Active time: 4~5 hours
- G.Storage temperature: -20°C to 70°C.
- H.Operation temperature: -5°C to 50°C.
- PS: LED sector: 15°
- At 50 cm: 2250 LUX
- Waterproof grade: IP65

H.C.B-B2091

110V WORK LIGHT (POWER SWITCH)

110V 工作燈 (附開關)



H.C.B-A2092

12V WORK LIGHT

12V 工作燈



H.C.B-C2294

NEW

LED POWER PACK LIGHT

LED 行動電源工作燈

■ Feature:

1. The mobile power can be removed to be used as an independent mobile power. It can support power to mobile phone or PAD.
- 2.The body is with strong magnet. The lamp can be rotated in 360 degree.
3. The slim body designed can be used in narrow place.
4. The power with safety device of excessive charged or excessive discharged.
5. The lamp have glitter function, it can used as a warning lamp.

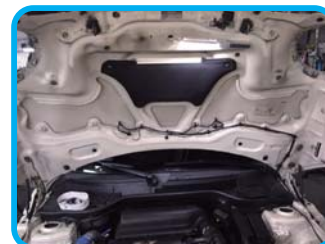

H.C.B-B2294 LED WORK LIGHT

LED 工作燈

- This light is with powerful magnet and hook which can rotate 360 degree freely and attach or hang on any place.
- This light is with cooling function which can extend the life-span of LEDs, prevent the LEDs from light fades, and ensure the quality.
- Specification:
Input voltage: 12 V.
Power consumption: 6 W.
Color temperature: White.
LEDs: 12.
Length/Width/Height: 24 mm/24 mm/300 mm.
Material: circuit board,aluminum,electric wire, plastic.



H.C.B-A2107 EXTRA LONG OFFSET BOX WRENCH KIT (8 PCS)

加長型梅花扳手組 (8 PCS)

Item	SPEC. (mm)	Length	Item	SPEC. (mm)	Length
A2107-1	8x10	235	A2107-5	14x17	370
A2107-2	10x12	295	A2107-6	16x18	405
A2107-3	12x14	330	A2107-7	17x19	405
A2107-4	13x15	370	A2107-8	22x24	435



H.C.B-B2107 EXTRA LONG OFFSET BOX WRENCH KIT (6 PCS)
(10 x 12 ,12 x 14 ,13 x 15 ,16 x 18 ,17 x 19 ,22 x 24 mm)

加長平型梅花扳手組 (6PCS) (10 x 12 ,12 x 14 ,13 x 15 ,16 x 18 ,17 x 19 ,22 x 24 mm)

- Special extra long design. Material is the chrome molybdenum.
- Easy to use in the confined space, such as pulley core screws and the water tank frame screws, etc.
- Contents : 10 X 12 ,12 x 14 ,13 x 15 ,16 , x 18 ,17 x 19 ,22 x 24 mm



H.C.B-A2111 UNIVERSAL ADJUSTABLE FUEL TANK LID REMOVER / INSTALLER

可調式汽油箱蓋拆裝器

- The fix bars are adjustable. It can be applied to all different sizes of fuel lid from 31 mm to 168 mm.
- The spline dimension is 6.2 mm. It is applicable to all different sizes of fuel lid convex from 5.6 mm to 6.2 mm.
- Application: all vehicle with salient fuel tank lid.
- Application: BENZ, BMW, CHRYSLER, European cars ... etc.

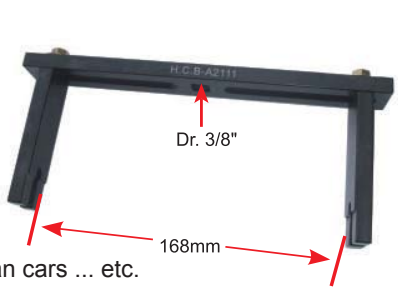



H.C.B-B2111

UNIVERSAL ADJUSTABLE FUEL TANK LID REMOVER / INSTALLER (IMPROVEMENT)

可調式汽油箱蓋拆裝器

- Jaw adjustable rang: 122~199 mm, suitable for different fuel tank lid.
- Special jaws design to remove/ install the tank closely.
- Used with Dr. 3/8" wrench.



H.C.B-D2111

UNIVERSAL ADJUSTABLE FUEL TANK LID REMOVER / INSTALLER

可調式汽油箱蓋拆裝器

- Jaw adjustable rang: 122~199 mm, suitable for different fuel tank lid.
- Special jaws design to remove/ install the tank closely.
- Used with Dr. 3/8" wrench.



H.C.B-A2144

LIFT SUPPORT FIXING CLAMP

升降桿固定器

- Use to fix the engine compartment, luggage area, and back door lift support.
- To prevent the lift from slipping and damaged.
- Place the tool on lift rod next to cylinder body. Tighten with knob until it is secure on lift rod when finished.



H.C.B-A2128

AIR HOSE REEL (10 METERS)

捲式風管 (10 米)

4 / 21 / 25 / 4.27'

- PU air hose is up to 300 psi (20 bar).
- ABS resin case, against impact.
- Easy installation on the wall or the ceiling.
- High impact and corrosion resistant.
- PVC water hose can bear up to 150 psi (10 bar).
- Suitable for commercial workspaces, industrial workspaces, automotive garages, and machine shops.
- Free rotation within 180°, and can be installed at 45°, 90°, 135° fixed angle.
- Metal spray gun, heat and cold resistant.

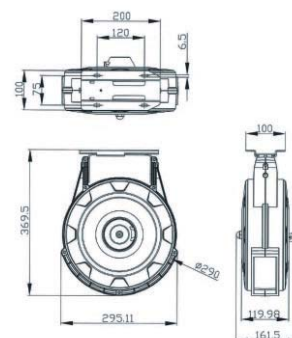

- 規格：
PU風管可承受300 psi (20 bar)
ABS外殼可防止撞擊
防撞 / 防鏽基座
組裝容易(只需螺絲起子即可組裝)
適用於商業、工業工作坊、維修廠和機械店
180° 轉動的捲軸，可提供廣大工作範圍。
也可以用45°、90° 和135° 角固定

Model	Name	Specifications	Max pressure
H.C.B-A2128	Air hose reel (10 meter)	Φ8 X Φ12 X 10M Φ5/16" X Φ15/32 X 33FT	300 psi

H.C.B-B2128

CORD REEL

捲式三插座

4 / 21 / 25 / 4.27'

■ **Specification:**

Plug can reach nearest outlet 3.3 FT.
ABS resin material against impact.
High impact/ corrosion resistant housing.

JIS (Japanese Industrial Standard) standard copper material.

Easy to install, lead wire with plug cap, plug cap, plugs into nearest receptacle.

Three outlets for use by three electric tools/ appliances simultaneously.

Easy installation-(Reel mounts only requires screw driver for assembly).

Ideal for use in commercial/ industrial workspaces, automotive garages and machine shops.

Reel swivels 180° to cover a wide work area or can be installed at 45°, 90°, 135° fixed angle.

■ **規格：**

風管可拉長至接近3.3呎

ABS外殼可防止撞擊

防撞 / 防鏽基座

符合JIS規格的銅材製造

電線和插座蓋安裝容易

三個插座，可供應三項電器使用

組裝容易(只需螺絲起子即可組裝)

適用於商業、工業工作坊、維修廠和機械店

180° 轉動的捲軸，可提供廣大工作範圍。也可以用45°、90° 和135° 角固定



H.C.B-C2128

CORD REEL+110V WORK LIGHT

捲式三插座 + 日光燈 (110V)

4 / 22.5 / 26 / 4.27'

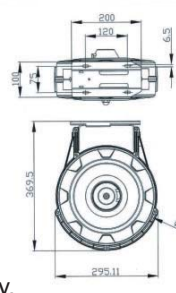

Model	Name	Specifications	Max Voltage	AMP
H.C.B-B2128	Cord reel	2.0 mm ² X 3C X 10m 14AWG X 3C X33FT	100~120V	12A
H.C.B-C2128	Cord Reel+110V work light	2.0 mm ² X 3C X 10m 14AWG X 3C X33FT	100~120V	12A

H.C.B-D2128

WATER HOSE REEL (8 METERS)

水管捲揚器 (8 米)

4 / 22.8 / 26.3 / 4.27'

- ABS resin case, against impact.
- Easy installation on the wall or the ceiling.
- High impact and corrosion resistant.
- PVC water hose can bear up to 150 psi (10 bar).
- Suitable for commercial workspaces, industrial workspaces, automotive garages, and machine shops.
- Free rotation within 180°, and can be installed at 45°, 90°, 135° fixed angle.
- Metal spray gun, heat and cold resistant.

■ **規格：**

ABS外殼可防止撞擊

易於安裝於牆上或屋頂上

防撞 / 防鏽基座

PVC水管可耐受150 psi (10 bar)

適用於商業、工業工作坊、維修廠和機械店

180° 轉動的捲軸，可提供廣大工作範圍。

也可以用45°、90° 和135° 角固定

金屬噴槍，耐熱又耐寒

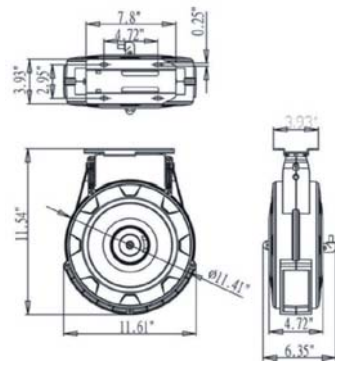

Model	Name	Specifications	Max Pressure
H.C.B-D2128	Water Hose Reel	ø 7.5 mm x ø 13 mm x ø 8 M ø 19/64" x ø 33/64" x ø 26 ft	150 psi

H.C.B-B2138 WORKING TABLE (CABINET)

美式工作桌 (加壁櫃)

- W 1525 x D 700 x H 1520
- 12 mm, block fiberboard.
- Tolerate the hammer beating without destroying the surface and the structure.
- Take round angle for preventing to be wounded.
- The length is suitable to hang on and take out.



H.C.B-B2138-1 FIXED HOOK

壁櫃掛勾

ITEM NO.	SIZE (INCH)
B2138-1-A	1"
B2138-1-B	2"
B2138-1-C	4"
B2138-1-D	8"



H.C.B-A2152 15 PCS CRAW FOOT WRENCH KIT

15 PCS 開口扳手

- Size: 8 mm, 9 mm, 10 mm, 11 mm, 12 mm, 13 mm, 14 mm, 15 mm, 16 mm, 17 mm, 18 mm, 19 mm, 21 mm, 22 mm, 24 mm.



H.C.B-A2140 OIL FILTER CRUSHER

機油芯壓平機

1 / 88.5 / 92.5 / 9.47'

■ Features:

1. This model is equipped with a cylinder powered by air/ hydraulic pump to crush oil filter and paint cans.
2. This unit can handle filters up to 9" long and 5" in diameter.
3. Crushing capacity: 20 tons.
4. Air pressure: 90 – 120 psi.
5. This model removes 85% of the residual oil from a predrained filters and crush filters to 1/6 of the original size, and the pain can to 1/10 original size.
6. Security switch is equipped to prevent pump from operating once the door opened.
7. High stand is designed for oil drainage with a drum placed underneath it.
8. Crushing time base on 10 CFM at 120 psi is 30 seconds.
9. This is an essential tool for environmental protection.

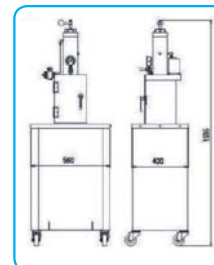

H.C.B-A2142 BATTERY ANALYZER

電瓶電量診斷儀



■ Notice

- 1.This machine is for 12V vehicle battery only.
- 2.Don't store the machine in high temperature or humidity place so as to prevent the machine from damage.
- 3.The working voltage range is 9V~15V DC, don't operate on a series battery (24V).
- 4.Operate after turn on the headlight 3~5 minutes to clean the surface voltage when the battery is full recharged.

■ 注意事項：

- 1.本產品為車輛12伏特電瓶專用之檢測工具。
- 2.請勿將本產品存放或使用於陽光會直接照射到之場所，或暴露於高溫、高濕中，否則可能會導致產品變形或損壞。本產品之工作電壓範圍為DC 9V~15V，請勿在串聯2顆電瓶(24V)的電壓下測試。
- 3.電瓶於剛充滿電後的狀態會有表面電壓的現象，可開啓頭燈3~5分鐘將表面電壓清除，建議再等待約5分鐘後再行測試。

JIS Battery Model Convert Chart

- 1.Please refer to the CCA values marked on the battery.
- 2.This table shows reference value of common JIS battery specification.
- 3.See the manual for details.
- 4.For testing single 12V battery only.
- 5.CMF: Closed Maintenance Free MF: Maintenance Free

Battery Model		Cold Cranking Amp (CCA)		
JIS(New)	JIS(Old)		MF	CMF
26A19	12N24-4	200	220	264
32C24	N40	240	325	400
34B19	NS40ZA	270	325	400
36B20	NS40Z	275	300	360
38B20	NX60-N24	330	340	410
46B24	NS60	325	360	420
48D26	N50	280	360	420
50D20		310	380	480
55D23		355	480	500
55B24	NX100-S6	435	420	500
55D26	N50Z	350	440	525
65D23		420	540	580
65D26	NS70	415	520	625
70D23	35-60	490	540	580
75D23		500	520	580
75D31	N70Z	450	540	735
80D26	NX110-5	580	580	630
95E41	N100	515	640	770
105E41	N100Z	580	720	880
115E41	NS120	650	800	960
115F51	N120	650	800	960
145G51	N150	780	900	1100
190H52	N200	925	1100	1300

H.C.B-A2164 UNIVERSAL BATTERY TESTER

多功能電瓶測試器

- This machine is for 12V vehicle battery only.
- Don't store the machine in high temp or humidity place. It'll damage the machine.
- The working voltage range is 9V~15V DC, don't operate on a series battery (24V).
- Operate after turn on the headlight 3~5 minutes to clean the surface voltage when the battery was just full recharged.
- Please refer to the CCA values marked on batteryMf: Maintenance free.
- This table shows reference value of common JIS battery specificationCMF: Closed maintenance free.
- For testing single 12V battery only.
- When testing battery right after engine off, analyzer will alarm.
- Please turn on the headlight for 2 minutes and follow the instructions being shown on LCD.





H.C.B-A2145 94 PCS (Dr. 1/4" & 1/2") TOOL KIT

94 PCS (Dr. 1/4" & 1/2") 套筒組

■ **Contents:**

- 13-1/4" Socket: 4-4.5-5-5.5-6-7-8-9-10-11-12-13-14 mm
- 18-1/2" Socket: 10-11-12-13-14-15-16-17-18-19-20-21-22-23-24-27-30-32 mm
- 5-1/2" Deep Socket: 14-15-17-19 mm
- 8-1/4" Deep Socket: 6-7-8-9-10-11-12-13 mm
- 1-1/2" Ratchet handle
- 1-1/4" Ratchet handle
- 2-1/4" Extension Bar 50 & 100 mm
- 2-1/2" Extension Bar 125 & 250 mm
- 1-1/4" Sliding T handle
- 1-1/2" Universal joint
- 2-1/2" Spark Plug Socket: 16 & 21 mm
- 1-1/4" Spanner handle
- 1-1/4" Universal joint
- 1-T-M head
- 1-Coupler
- 1-1/4" Flexible Extension Bar 150 mm
- 17-1/4" Bit-Sockets: (-) 4/5.5/7, (+)#1/2, (*)#1/2, (H)3/4/5/6, (T)8/10/15/20/25/30
- 15-Bits: (-)8-10-12, (+)#3-4, (*)#3-4, (H)8-10-12-14, (T)40-45-50-55



H.C.B-A2146 PNEUMATIC GREASE PUMP (20 L)

氣動黃油機 (20 升)

- Pneumatic grease pump uses air as power to suck grease into lubrication points. It is suitable for using with machines, automobiles and vessels... ect. It is a very useful tool for lubrication and maintenance.

分離式幫浦，取用壓縮空氣驅動抽取流質液體，幫浦為兩個獨立循環系統，空氣水份不致接觸油質，適用於各種機械、車輛、飛機、輪船等，為保養潤滑時強勁注入黃油的利器。



Model 型號	Capacity 容量	Air Input Pressure 容氣輸入壓力	Pressure Ratio 壓力比	Grease Output Pressure 黃油輸出壓力	Deliver Rate 輸出量	Hose Length 油管長度	N.W. 淨重	G.W. 毛重	CUFT 材積
H.C.B-A2146	20L	4-9Kg/cm ²	45:1	180-405Kg/cm ²	30cc/sec	10 ft	20.9Kgs	23.4Kgs	6.2'

H.C.B-A2151 3/8" SPARK PLUG SOCKET KIT

3/8" 火星塞套筒組

- 9016, 25016 are 16 mm hexagon socket, used on spark plug.
- 9014, 25014 are 14 mm double-hexagon socket, used for spark plug on CITROEN C5 HPI, PEUGEOT 406 HP1 and RENAULT CLIO 1.2 16V, TWINGO 1.2 16V BMW X5

Item No.	Size	Drive	L(mm)	Wt. (g)
A2151-9014	14 mm	3/8"	90	92
A2151-25014	14 mm	3/8"	250	274
Item No.	Size	Drive	L(mm)	Wt. (g)
A2151-9016	16mm	3/8"	90	132
A2151-25016	16mm	3/8"	250	380

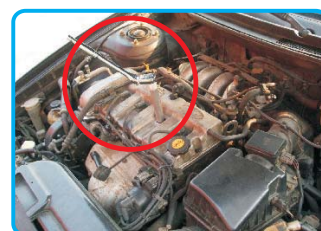

H.C.B-A2162 38 PCS SOCKET KIT

38 PCS 套筒組



Sort No.	Description	Specification	Q'ty
1	Extention Bar	3/8" x 10"	1 pc
		3/8" x 6"	1 pc
		3/8" x 3"	1 pc
		3/8" x 1 1/4"	1 pc
2	3/8" DR. 12PT. Socket	8 mm	1 pc
		10 mm	1 pc
		12 mm	1 pc
		13 mm	1 pc
		14 mm	1 pc
		15 mm	1 pc
		16 mm	1 pc
		17 mm	1 pc
		18 mm	1 pc
		19 mm	1 pc
		22 mm	1 pc
3	3/8" DR. E Socket	6 mm	1 pc
		8 mm	1 pc
		10 mm	1 pc
		12 mm	1 pc
4	3/8" Universal Joint	14 mm	1 pc
			1 pc
5	3/8" Hex (L=50mm)	5 mm	1 pc
		6 mm	1 pc
		7 mm	1 pc
6	3/8" Torex (L=50mm)	8 mm	1 pc
		T20	1 pc
		T25	1 pc
		T27	1 pc
		T30	1 pc
		T40	1 pc
7	3/8" Sliding T Bar	T45	1 pc
		T50	1 pc
8	3/8" Ratchet Handle		1 pc
		72T	1 pc
9	3/8" Deep Socket Slim Nose	10 mm	1 pc
		13 mm	1 pc
		17 mm	1 pc
10	3/8" Magnetic Spark Plug Socket	16 mm	1 pc
			1 pc
Tool Box(Size: 320 x 150 mm)			

H.C.B-A2153

UNDER HOIST STAND

圓柱型支撐架 (腳踏型)

- Capacity: 3/4 ton.
- Height range: 1400 – 2065 mm.
- Base size : Φ 305 mm.
- Controlled by foot.



H.C.B-A2163 UNIVERSAL ENGINE BELT TENSION TESTER

萬用引擎皮帶張力測試器

- This tool can be used for testing the tension on the engine belt of cars.
- Simply to check the belt for proper tension.
- Application: all common types of engine belt. Including timing, ribbed, tooth and V-belt.

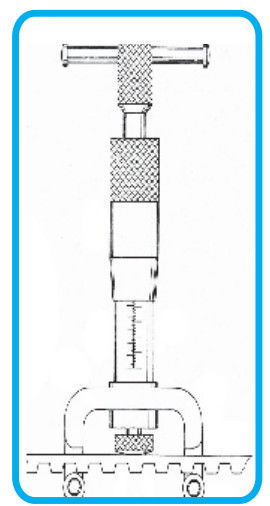
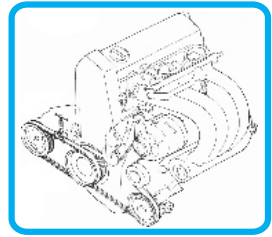



010
HWANG CHERNG BIN
Specialty Tools Inc.

SINCE 1990

General Repair
Equipment



H.C.B-A2165 HYDRAULIC BEARING PULLER (8 TONS)

油壓式培林拔輪器 (8 噸)

H.C.B-B2165

HYDRAULIC BEARING PULLER (8 TONS)

油壓式培林拔輪器 (8 噸)

H.C.B-C2165

HYDRAULIC BEARING PULLER (12 TONS)

油壓式培林拔輪器 (12 噸)

H.C.B-D2165

HYDRAULIC BEARING PULLERS (4 TONS)

油壓式培林拔卸器 (4 噸)

- Four stages of foldable & removable handle saves the handle force during operation.
- 360° rotary socket.
- Self-contained hydraulic pump and puller body with integral safety valve.
- Heat treated & chrome plated hydraulic cylinder rod provides linear force.
- Easily release valve.
- Spring loaded live centering nut for easy job (removable).
- 2/3 jaws combination puller cross head with manganous-phosphate plated for rust proof and durability.
- Heat treated forged alloy steel cross bolts & jaws with manganous-phosphate plated for rust proof and long life service.



H.C.B-A2165
H.C.B-D2165



H.C.B-B2165



H.C.B-C2165

Item No.	CAPACITY	Reach(mm)		Spread(mm)		Stroke(mm)			Pump Tip(mm)			Jaw Tip(mm)			Weight (Kg)
		A	B	C	D	H	E	F	G	A	B	C	I		
H.C.B-A2165	8 TONS	270	-	95	220	85	50	25	122	-	-	-	-	-	14.3
H.C.B-B2165	8 TONS	229	57	100	350	85	50	25	122	11	10	25	51	8.2	
H.C.B-C2165	12 TONS	381	-	120	290	85	60	28	118	-	-	-	-	18.0	
H.C.B-D2165	4 TONS	250	-	55	110	60	42	22	84	-	-	-	-	7.6	

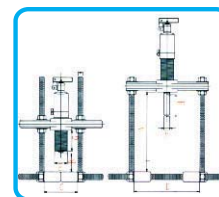
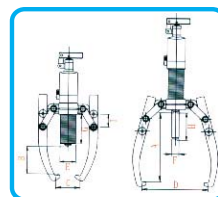

HYDRAULIC BEARING PULLER 油壓式培林拔輪器

- 四段式的折疊、可移除的手把，讓操作更省力。
- 360° 旋轉式套筒。
- 包含一體成型的油壓組和附有安全閥門的拔取器。
- 熱處理鍍鉻油壓桿，提供更強的拔取力。
- 方便操作的閥門。
- 可更換式彈簧支撐中心螺帽，方便操作。
- 鍍磷酸錳的拔取爪，可防塵、更耐用。
- 熱處理鍍磷酸錳螺絲，可防塵、更耐用。

H.C.B-A2167 STAR-E SOCKET KIT (5 PCS) (Dr. 1/2", E10/E12/E14/E16/E18)

E 型套筒組 (5 PCS) (Dr. 1/2", E10/E12/E14/E16/E18)

12 / 19 / 19.5 / 0.55"

- Dr. 1/2", 140 mm Length
- E10, E12, E14, E16, E18.





010
HWANG CHERNG BIN
 Specialty Tools Inc.

一般修護工具 修護設備
 General Repair Equipment

H.C.B-A1296

3 PCS BENT WRENCH

3 PCS 單頭彎柄梅花扳手

- Size: 12 mm, 13 mm, 14 mm.
- Length: 150 mm.
- Convenient in tiny space (ex: Chassis, Door handle...)



General Repair
 Equipment

H.C.B-A1298

FLEX SWIVEL GEARTECH WRENCH

正反轉搖頭棘輪扳手

- Flex Head Geartech, Combination Wrench
- 180° flex head design
- Size: 8 mm, 9 mm, 10 mm, 11 mm, 12 mm, 13 mm, 14 mm, 15 mm, 16 mm, 17 mm, 18 mm, 19 mm



H.C.B-A2141

ELECTRIC CIRCUIT TESTER

供電型驗電筆

- Power up components.
- Prior to fitting including:
 - Cooling fan motors
 - Fuel pumps
 - Window & sunroof motors
 - Wiper motors
 - Fuel Pumps
 - Relays & Lamps
- Test continuity in:
 - Switches
 - Relays
 - Diodes & fuses
 - Wiring harnesses
- Polarity test cables and sockets.
- Find short circuits and bad earths fast.
- Powered by vehicles own 6-24 Volt DC power supply – supplied with 4.5 mt of cable.
- Fitted with sensitive trip device to prevent circuit damage.
- Computer safe.





H.C.B-A2176 4 PCS DOUBLE WRENCH (E TYPE)

4 PCS 扳手 (E 型)

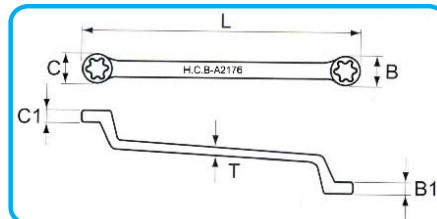

Material: Chorme vanadium, mat finished.

Size	L(mm)	Item No	C(mm)	B(mm)	C1(mm)	B1(mm)	T(mm)	WT(g)
6x8	168	H.C.B-A2176-1	12.0	10.0	6.4	6.0	4.2	50
10x12	205	H.C.B-A2176-2	17.0	14.5	7.5	7.0	4.8	85
14x18	245	H.C.B-A2176-3	22.0	18.0	9.0	8.2	5.5	145
20x24	265	H.C.B-A2176-4	29.5	25.5	12.0	11.0	6.5	240

H.C.B-A2177 5 PCS HALF-MOON RING WRENCH

5 PCS 扳手 (半月型)

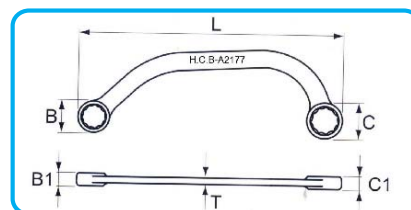

Material: Chorme vanadium, silvering finished.

SIZE	L(mm)	ITEM NO.	C(mm)	B(mm)	C1(mm)	B1(mm)	T(mm)	WT(g)
10x12	141	H.C.B-A2177-1	15.6	18.2	6.6	6.5	4.2	56
11x13	166	H.C.B-A2177-2	18.2	21.0	8.2	8.0	4.9	93
14x17	190	H.C.B-A2177-3	22	25	9.2	8.2	5.3	134
16x18	220	H.C.B-A2177-4	25.5	28	9.6	8.8	5.6	180
19x22	256	H.C.B-A2177-5	28.6	32.5	11.1	10.1	6.6	240

H.C.B-A2182 COOLING SYSTEM VACUUM PURGE & REFILL KIT

真空式水箱水更換器

10 / 15 / 16 / 3.44'



- No more bleeding and save the time of clean up.
- Easy to connect with air pump and creates a vacuum.
- Attaching the filler hose, opening the valve and letting the pre-mixed coolant flow into the system.



Fill new radiator liquid



Vacuum by air

H.C.B-A2190 FINGER RATCHET (Dr. 1/4" & 1/4" Hex.)

掌心雷棘輪 (Dr. 1/4" 頭 & 1/4" 孔)

- Features and benefits:
New finger style ratchet.
Small size works great for extremely tight areas.
Aluminum knurled outer ring for sure grip.
Reversible ratchet.
Dr. 1/4" on one side and 1/4" hex drive on other side.
Size: 28 mm Dia. x 35 mm L.



Joins to screwdriver bit



Joins to socket









H.C.B-A2191 NOISE STETHOSCOPE

異音聽診器

- To search for the noise resources of car.
- Including holding sensor, magnetic sensor, sucker sensor and clipping sensor, to deal with different places in the car.



■ Specification:

Holding sensor	Magnetic sensor	Sucker sensor	Clipping sensor
 1pc	 2pcs	 2pcs	 2pcs
Earphone	Main Body	Power line	Sensor extended line
 1pc	 1pc	 1pc	 4pcs

H.C.B-A2169

13 PCS T-HANDLE SOCKET WRENCH KIT

13 PCS T 桿套筒組



Sort No.	Description	Specification	Q'ty
1	T-Handle	100*61 mm	1pc
2	Dr. 1/4" Joint		1pc
3	Socket L=200mm	5 mm	1pc
		5.5 mm	1pc
		6 mm	1pc
		7 mm	1pc
		8 mm	1pc
		9 mm	1pc
		10 mm	1pc
		11 mm	1pc
		12 mm	1pc
		13 mm	1pc
		14 mm	1pc
Total: 13 pcs in a Tool Box			13pc

H.C.B-A2196

AUTO COMPUTER MEMORY UNIT

電瓶繼電器



	1.Remove the key.
	2.Connect H.C.B-A2196 to the OBDII connector on the vehicle.
	3. Go step 4 after first green light. ※It is bad connection or unavailable detection when you can't see the first green light.
	4. Connect spare power.
	5. Make sure there are 2 green lights, the red light means the capacity of spare power is not enough. 6.Close all doors. 7. Replace the battery.

■ Attention:
Please replace the battery after closing all doors. The indoor light will spend extra power if any door is opened.

H.C.B-A2203 PNEUMATIC FLUID EXTRACTOR (8.5 L)

氣動抽油機 (8.5 L)

4 / 6 / 10 / 3.8'

- Extracting new series of car engine oil. Capacity 8.5 L.
- Pneumatic extractor, non-sparking making.
- Only need one person to operate.
- 1 meter silicon hose with universal rubber adapters can assemble with most of brake fittings.
- Special fixing valve and safety cup are for automatic cut-off extracting.
- 可抽取汽車機油，最大容積8.5公升。
- 氣動式抽取，不會產生火花。
- 只需一人即可操作。
- 1公尺長矽膠管配上萬用橡膠接頭，可用於大部份的車輛。
- 特殊的固定式閥門和安全杯，可自動中斷抽油動作。

ADAPTER (OPTION):

- NITTO ■ MILTON ■ ORION

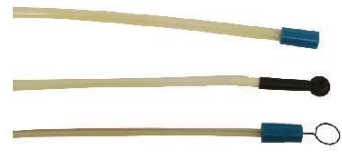

SPECIFICATIONS:

* Air inlet	1/4"
* Avg. Air cons	2 CFM
* Working pressure	40 ~ 170 PSI
* Temperature range	-19.4°C ~ 60 C
* Max. Capacity	8500 c.c. °

H.C.B-A2205 BASIC BRAKE OIL EXTRACTOR (2000 c.c.)

專業剎車油吸取機 (2000 c.c.)

12 / 15 / 16 / 6'

- Economical - fast and easy, reduce labor costs.
- Versatile - handle most standard and ABS brake systems.
- Clean - collect old brake fluid without spillage.
- Quiet - integrated silencer for a quiet working environment.
- Silicon suction assemblies with universal rubber fitting.
- 經濟－快速、簡便，可節省人力成本
- 用途多－可用於大部份標準和ABS煞車系統
- 乾淨－收集廢油、不用擔心溢漏
- 快速－一體成型式消音器，提供安靜的工作環境
- 配備有矽膠抽取器和萬用橡膠接頭

ADAPTER(OPTION):

- NITTO ■ MILTON ■ ORION



SPECIFICATIONS:

* Air inlet	1/4"
* Avg. Air cons	2 CFM
* Working pressure	40 ~ 170 PSI
* Temperature range	-19.4°C ~ 60°C
* Max. Capacity	2000 c.c.

H.C.B-A2206 BRAKE OIL FILLER (1000 c.c.)

剎車油補充油瓶 (1000 c.c.)

12 / 7 / 8 / 1.8'

- To fill brake oil easily.
- Capacity: 1000 c.c..
- 方便灌注剎車油
- 容量：1000 c.c.



ADAPTER(OPTION):

- NITTO ■ MILTON ■ ORION

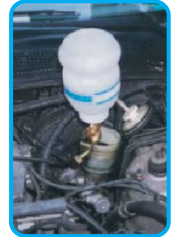
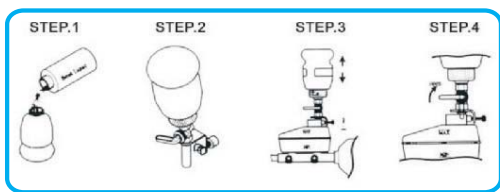



H.C.B-A2227

Dr. 1/2" TX-STAR UNIVERSAL BIT SOCKET KIT (8 PCS)
(T30/T40/T45/T50/T55/T60/T70)

Dr. 1/2" 六角星型通用套筒組 (8 PCS) (T30/T40/T45/T50/T55/T60/T70)

12 / 15.7 / 16.2 / 0.58'

- ★ 7-Tx-star: T30, T40, T45, T50, T55, T60, T70
- ★ 1-1/2" Square drive, universal socket adapter



H.C.B-B2227

Dr. 1/2" XZN (SPLINE) UNIVERSAL BIT SOCKET KIT (8 PCS)
(M5/M6/M8/M10/M12/M14/M16/1/2" ADAPTER)

Dr. 1/2" 十二角型通用套筒組 (8 PCS) (M5/M6/M8/M10/M12/M14/M16/1/2" ADAPTER)

12 / 15.8 / 16.3 / 0.58'

- ★ 7-XZN: M5, M6, M8, M10, M12, M14, M16
- ★ 1-1/2" Square drive, universal socket adapter



H.C.B-C2227

Dr. 1/2" RIBE UNIVERSAL BIT SOCKET KIT (8 PCS)
(M6/M7/M8/M9/M10/M12/M14&1/2" ADAPTER)

Dr. 1/2" 六角齒輪型通用套筒組 (8 PCS) (M6/M7/M8/M9/M10/M12/M14&1/2" ADAPTER)

12 / 15.6 / 16.1 / 0.58'

- ★ 7-Ribe: M6, M7, M8, M9, M10, M12, M14
- ★ 1- 1/2" Square Drive, Universal Socket Adapter



H.C.B-A2229

Dr. 1/2" DEEP STAR-E IMPACT SOCKET KIT (9 PCS)
(78 mm) (E10/E11/E12/E14/E16/E18/E20/E22/E24)

Dr. 1/2" 星形長套筒組 (9 PCS) (78 mm) (E10/E11/E12/E14/E16/E18/E20/E22/E24)

15 / 20 / 20.5 / 0.8'

- ★ 9-78 mm (L)
- ★ E10, E11, E12, E14, E16, E18, E20, E22, E24



H.C.B-A1426 **TOYOTA、SUBARU、DAIHATSU OIL FILTER WRENCH (Dr. 1/2", 14 POINTS, 65.5 mm)**

TOYOTA、SUBARU、DAIHATSU 機油芯扳手 (Dr. 1/2", 14 角, 65.5 mm)

- Size: Dr. 1/2", 14 POINTS, 65.5 mm
- Application : TOYOTA, SUBARU Justy and DAIHATSU Sirion.



H.C.B-B2167 **STAR-E SOCKET KIT (6 PCS) (Dr. 1/2", E10/E12/E14/E16/E18/E20)**

E 型套筒組 (6 PCS) (Dr. 1/2", E10/E12/E14/E16/E18/E20)

- For cylinder-head bolts on BMW, Mercedes CDI engines.
- Length – 140 mm.
- Size: E10, E12, E14, E16, E18, E20.



H.C.B-A2230 **Dr. 3/4" TX-STAR & SPLINE IMPACT BIT SOCKET KIT (6 PCS) (61 mm) (T70/T80/T90/T100/M16/M18)**

Dr. 3/4" 氣動星形 12 角凸型套筒組 (6 PCS) (61 mm) (T70/T80/T90/T100/M16/M18)

10 / CTN / 18.2 / 18.7 / 0.72'

- ★ TRX-Star: T70, T80, T90, T100
- ★ Spline: M16, M18
- Length: 61 mm
- Material: CR-MO

M16 Application: Touareg Phaeton from 2003, braking system, camshaft drive gear, caliper, rear.
M18 Application: Touran 2004 • Audi A3 from 2004, landing gear assembly and disassembly, wheel bearing / hub unit.



H.C.B-B2230 **3/4" SQ. DRIVE HEXAGON & SPLINE IMPACT BIT SOCKET KIT (9 PCS) (61 mm) (14/17/19/21/22/23/24 mm/M16/M18)**

Dr. 3/4" 氣動 6 角 & 12 角套筒組 (9 PCS) (61 mm) (14/17/19/21/22/23/24 mm/M16/M18)

- Material: CR-MO with special blue finish or manganese phosphate.
- Overall Length: 61 mm.
- Size: 7 - Hexagon : 14-17-19-21-22-23-24 mm
2 - Spline : M16-18
- Durable Chrome Molybdenum steel gives optimum balance between hardness and flexibility.
- Suitable for using with any impact tool.



H.C.B-C2230

3/4" SQ. DRIVE HEXAGON & TX-STAR IMPACT BIT SOCKET KIT (9 PCS) (61 mm) (19/ 21/ 22/ 23/ 24 mm/ T70/ 80/ 90/ 100)

Dr. 3/4" 氣動星形 12 角凸型套筒組 (9 PCS) (61 mm) (19/21/22/23/24 mm/T70/80/90/100)

- Material : CR-MO with special blue finish or manganese phosphate.
- Overall Length: 61 mm.
- Size: 5 - Hexagon: 19-21-22-23-24 mm.
4 - TX-Star: T70-80-90-100.
- Durable Chrome Molybdenum steel gives optimum balance between hardness and flexibility.
- Suitable for using with any impact tool.



H.C.B-A2236

7 PCS GLOW PLUG SOCKET KIT (with 3" EXTENBAR)

7 PCS 預熱塞火星塞套筒組 (含 3" 接桿)

12 / CTN / 15 / 16 / 1.1'

- Specially designed for the removal and replacement of glow plugs easily.
- 6 PCS: 8.9.10.12.14.16 mm (12 – point).
- 1 PCS: 3" EXTENSION BAR.
- Dr. 3/8 "



H.C.B-B2235

AUTOMATIC TRANSMISSION OIL FILLING KIT (12.5 L)

通用變速箱補充瓶 (12.5 公升)

ITEM NO	DESCRIPTION	THREAD	APPLICATION
NO.1 B2235-1	FORD ATF REFILL ADAPTER	1/8" NTP	FORD
NO.2 B2235-2	VOLVO ATF REFILL ADAPTER	5/16-24UNF	VOLVO
NO.3 B2235-3	VW ATF REFILL ADAPTER	10X1.2	VOLKSWAGEN
NO.4 B2235-4	VW ATF REFILL ADAPTER, SHORT	N/A	VOLKSWAGEN
NO.5 B2235-5	VW ATF REFILL ADAPTR, LONG	N/A	VOLKSWAGEN
NO.6 B2235-6	ANGLED ATF REFILL ADAPTE	N/A	BMW, HONDA, NISSAN
NO.7 B2235-7	TOYOTA ATF REFILL ADAPTE	18X1.5	TOYOTA
NO.8 B2235-8	VW/AUDI ATF REFILL ADAPTER	24X1.5	VW, AUDI W/DSG TRANSMISSION
NO.9 B2235-9	AUDI ATF REFILL ADAPTER	22X1.5	AUDI W/CVT TRANSMISSION
NO.10 B2235-10	MERCEDES ATF REFILL ADAPTER	12X1.5	MERCEDES W/722.9 TRANSMISSION



H.C.B-C2235 AUTOMATIC TRANSMISSION OIL FILLING KIT (7.5 L) (14 PCS)

通用變速箱補充瓶 (7.5 公升) (14 PCS)

- The unit is designed to fill fluid in transmission, differentials and transfer cases.

C2235-1	FORD	1/8 NPT
C2235-2	UNIVERSAL(BMW,HONDA,NISSAN)	
C2235-3	VW/AUDI	Short adapter
C2235-4	VW/AUDI,PORSCHE	Long Adapter
C2235-5	VW/AUDI,MINI COOPER	
C2235-6	BENZ 722.9	M12x1.5
C2235-7	VW/AUDI DSGM	24x1.5
C2235-8	VW/AUDI CVTM	22x1.5
C2235-9	VOLVO	
C2235-10	TOYOTA/LEXUS	
C2235-11	SKODA	
C2235-12	VW/Passat and Tiguan after 2007	
C2235-13	Infiniti 7speed	
C2235-14	Universal (HONDA , Hyundai, Kia.)	



H.C.B-A2235 AUTOMATIC TRANSMISSION OIL FILLING KIT (7.5 L)

通用變速箱補充瓶 (7.5 公升)



Operating Instruction:

1. Open the filling cap on the reservoir. Fill in dispensing fluid
2. Tank capacity is 7.5 L.
3. Find the suitable adaptor from the selection and connect to the vehicle.
4. Connect the adaptor with dispensing hose.
5. Push-pull the dispensing handle to begin the operation.

A2235-1	FORD	1/8 NPT
A2235-2	UNIVERSAL(BMW, HONDA,NISSAN)	
A2235-3	VW/AUDI	Short adapter
A2235-4	VW/AUDI,PORSCHE	Long Adapter
A2235-5	VW/AUDI,MINI COOPER	
A2235-6	BENZ 722.9	M12x1.5
A2235-7	VW/AUDI DSG	M24x1.5
A2235-8	VW/AUDI CVT	M22x1.5



H.C.B-A2253

BEARING SEPARATOR (20~150 mm)

培林拆卸器 (20~150 mm)

- Forged steel jaws.
- Suitable for removing bearings, gears and bushes from shafts.

ITEM NO	SIZE
A2253-1	20-40 mm
A2253-2	30-50 mm
A2253-3	50-75 mm
A2253-4	75-105 mm
A2253-5	105-150 mm



H.C.B-A1655

NEW

UNIVERSAL BEARING EXTRACTOR

萬用培林拆卸器

- For extracting inner bearings, bearing outer rings and bushings.
- Mechanical pressure screw.
- Milled thread treated with special coating.
- Strong design, high performance and long service life.
- Safety label to ensure protection of intellectual property.
- Self-healing corrosion protection for galvanized parts.



No.								
	mm	inch	mm	inch	mm	inch	Segment	kg
A1655-01	6 - 10	15/64 - 25/64	14	9/16	73	2 7/8	2	0.12
A1655-02	8 - 12	5/16 - 15/32	14	9/16	73	2 7/8	2	0.115
A1655-03	10 - 14	25/64 - 9/16	14	9/16	73	2 7/8	2	0.115
A1655-04	12 - 16	15/32 - 5/8	25	1	72	2 27/32	2	0.16
A1655-05	14 - 19	9/16 - 3/4	27	1 1/16	72	2 27/32	2	0.12
A1655-06	18 - 23	23/32 - 29/32	35	1 3/8	89	3 1/2	2	0.225
A1655-07	20 - 30	25/32 - 1 3/16	40	1 9/16	92	3 5/8	2	0.235
A1655-08	28 - 40	1 7/64 - 1 9/16	23	29/32	101	3 31/32	2	0.395
A1655-09	35 - 46	1 3/8 - 1 13/16	50	1 31/32	113	4 7/16	2	0.68
A1655-10	45 - 58	1 25/32 - 2 9/32	85	3 11/32	135	5 5/16	2	1.23

H.C.B-A2254

9.75" PROFESSIONAL CRIMPING TOOL

9.75" 撥線鉗

- Material: Carbon steel HRC: 48°~53°.
- Function:
 1. Wire cutter
 2. Crimps insulated terminals
 3. Bolt cutter
 4. Crimps non- insulated terminals
 5. Open barrel terminals
 6. Wire stripper
 7. Crimps pin terminals
 8. Bending wire





010
HWANG CHERNG BIN
 Specialty Tools Inc.

一般修護工具 修護設備
General Repair Equipment

H.C.B-A2257

FUEL GAUGE & PUMP SENDER COLLAR WRENCH

燃油壓力錶 & 泵浦油箱蓋扳手

- Innovative tool for installation & removal of fuel pump/gauge sender collars.
- Adjustable to suit most collars from 89 to 170 mm.
- Lock in place and then turn with a 19 mm wrench or socket.
- A damage free method of removing & re-fitting collars.
- A universal alternative to OEM tools.



H.C.B-A1502

20 TON AIR/HYDRAULIC FLOOR JACK-LOW PROFILE

20 TON 氣動 / 油壓千斤頂 (超低型)

- **INTENDED USE:**
 Heavy duty truck, agricultural and heavy construction equipment. Ideal for loaded truck and trailer roadside service calls.
- Long handle with 36-1/2" reach helps in positioning jack under vehicles with low overhang.
- May be stored in a vertical position.
- Hand grip also works as a stand to store the jack in a vertical position.
- Compact design fits easily between tandem wheels.
- Parkerized coating on pump piston, extension screw and extension adapters and chrome coated ram offer protection against rust.
- Removable extension screw is used with the two 4" extension adapters (included) for added height when necessary.
- Self-retracting ram eliminates manual lowering of the jack.
- 5 1/4" diameter high impact composite wheels make maneuverability easy.
- Fast efficient air pump reduces lifting time and has a built-in relief mechanism which prevents the jack from being used beyond its maximum capacity.
- Convenient push button air valve connected to an in-line filter prohibits contaminants from entering the air/hydraulic system.

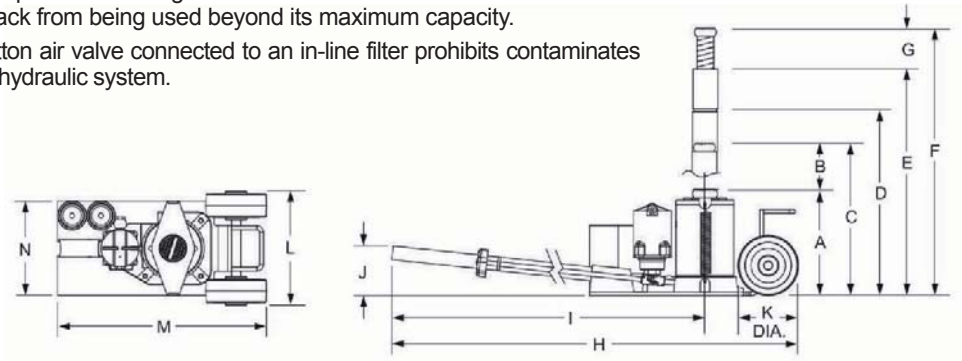

MODEL NUMBER	CAPACITY	PSI RANGE	A	B	C	D	E	F	G	H	I	J	K	L	M	N	SHIPPING WEIGHT (Lbs.)
A1502	20 TON	100-130	8.625"	4"	12.75"	16.75"	20.75"	22.75"	2.75"	53"	36.5"	6.25"	5.25"	9.25"	17.25"	7.75"	63

Low Lift Height	High Lift Height	Stroke	Screw Extension	Base Size	P.S.I. Range	Shipping Weight
8.625	22.75"	4"	2.75"	9.25" x 17.25"	100-130	63 lbs

General Repair Equipment



H.C.B-B1502

20 TON AIR/HYDRAULIC TRUCK JACK-LOW TYPE

20 TON 氣動 / 油壓千斤頂

- Professional use in repairing heavy duty truck, agricultural and heavy construction equipment.
- Ideal for loaded truck and trailer roadside service.
- Compact low profile design for maximum access, fit easily and safely between wheels of a tandem axle vehicle.
- "T" handle allows jack operation at any handle position.
- Handle locking lever secures handle in either vertical, horizontal or 45 degree position.
- Self-retracting ram eliminates manual lowering of jack.
- Quick rated capacities life using air actuated operation.
- Automatic by-pass mechanism protects user and hydraulic cylinder from over pumping danger.
- Rust inhibitive coating on ram and extension screw.
- Extension screw gives added height when necessary.



Model	Capacity (Ton)	Stroke (mm)	Min. Height (mm)	Max. Height (mm)	Ext. Bar (A) mm	Ext. Bar (B) mm	Ext. Bar (C) mm	L x W x H (mm)	Weight (kgs)
B1502	20	90	190	280	15	40	60	570x140x1100	29

H.C.B-C1502

50 TON AIR/HYDRAULIC JACK

50 TON 氣動 / 油壓千斤頂

- Low profile design for most of industrial applications.
- Forged base as the strongest construction to catch the needs in industry market.
- Housing welding onto the forged base makes to be free of leakage problem as well.
- Telescopic design of C1502 reaches the extra needed during operating to save time and labor cost much.
- This jack is equipped with two large Dia. Rubber wheels provide the greatest convenience and mobility you need.



H.C.B-C1051 TOOL CABINET

壁櫃

- Manufactured with heavy gauge sheet steel for extra strength and durability.
- Superb quality lockable 2 door wall cabinet.
- It combines easy access and tool storage with security.
- Dimensions: W: 900 mm D: 215 mm H: 1000 mm.
- 厚規格鋼板製造可增加強度與耐久性.
- 具有精湛品質且有上鎖功能的櫥櫃,是保養場技工的最佳儲物櫃!
- 多孔設計可方便拿取與存放.
- 規格: 寬:900 mm 深:215 mm 高:1000 mm



H.C.B-C1051-001
(Not Include tools)

ITEM NO	C1051-002	C1051-003	C1051-004	C1051-005	C1051-006	C1051-007	
Description	TOOL HOOK inclined hook end	TOOL HOOK inclined hook end	TOOL HOLDER vertical hook end	TOOL HOLDER double,vertical hook end	TOOL HOLDER double,vertical hook end	TOOL HOOK inclined hook end	
PHOTO							
Q'TY	6	5	1	2	3	2	
ITEM NO	C1051-008	C1051-009	C1051-010	C1051-011	C1051-012	C1051-013	C1051-014
TOOL HOOK for wrench	TOOL HOLDER double,vertical hook end	TOOL HOLDER double,vertical hook end	SPRING CLAMP	Ø4 x 50 L TOOL HOLDER for wrench	Tool holder for screwdrivers	ROUND HOLDER	
1	12	1	2	3	1	1	
ITEM NO	C1051-015	C1051-016	C1051-017	C1051-018	C1051-019	C1051-020	C1051-021
Socket holder	Socket holder	Socket holder	Socket holder	Socket holder	Tool holder for screwdrivers	Tool holder for screwdrivers	
1	2	1	1	1	2	3	
ITEM NO	C1051-022	C1051-023	C1051-024	C1051-025	C1051-026	C1051-027	
Tool holder for torque wrench	Tool holder for screwdrivers	Tool holder	Drill-bit holder With 5 holes	TOOL HOLDER double, vertical hook end	clamp		
2	1	2	1	14	100		



H.C.B-A6005-5 TOOL HOLDER(5 SLICES)

工具櫃 (5 片)

- Easy to install and disassemble, small size for transportation; double hooks for hanging a variety of tools.
- The plate thickness 1.5 mm, robust, easy to change.
- Customize: Can be made according to customer requirements size with color.

- 易於安裝和拆卸，運輸體積小
- 雙面掛鉤，可以掛各種各樣的工具
- 板子厚度1.5MM，堅固結實，不易變型
- 可以根據客戶要求做尺寸跟顏色

Item no	Description
A6005-3	3 slices
A6005-4	4 slices
A6005-5	5 slices
A6005-8	8 slices



H.C.B-A2265 PORTABLE MINI FLOOR JACK

輕便型油壓剪式千斤頂

- Low profile and wide lifting range, from 153 mm to 368 (6" to 14").
- Four wheels provide user position jack easier and faster.
- Built-in spring can lower vehicle and lower jack to lowest position easily.
- High strength plastic saddle designed to receive panel rail and avoid damaging vehicle body.
- Big and heavy cast iron base provides stability when loaded.
- Built-in stopper to prevent ram from over-traveling.
- Scissor' assembly and handle adopt electro deposition coating.
- This special treatment provides outside appearance highest protection, so it never peels off.
- High operating effort, only 14 kgs (31 lbs) force is required to operate.
- Compact size and light weight (gross weight 7.3 kgs/16 lbs) easy for carrying and operating.
- Purpose: For lifting one wheel of the vehicle's gross weight below 2000kgs (4400 lbs) off the ground in order to change a tire or install snow chains.

- 低機身及大揚程(自153 mm到368 mm)
- 搭配四個滾輪方便使用者更迅速地定位。
- 內藏式強力彈簧讓千斤頂更容易完全收合。
- 高強度塑膠鞍座的設計以配合車子的千斤頂托架並避免傷及車子鈹金和烤漆。
- 巨大且沉重的鐵板座於承載時提供更高的穩定性。
- 內藏式制止器以防超高使用而發生危險。
- 頂昇臂組和手把採電鍍處理，不易刮傷生鏽。
- 高超的效率，只需14kg的使力即可操作。
- 輕巧體積與超輕重量容易攜帶與使用。
- 用途：適用於總重在2000kgs以下車輛

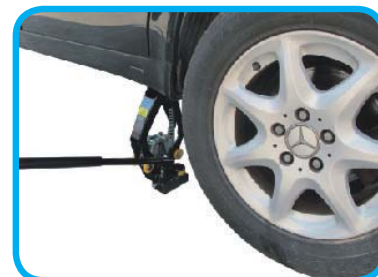

H.C.B-A2258

TOE JACK

L 型油壓千斤頂

- Heat treated & chrome plated hydraulic rod provide longer seal life and optimum performance.
- Internal safety valve prevents toe jack from over its rated capacity.
- Housing welding onto the forged base can avoid leakage problem.
- Removable handle saves the handle force during operation.
- High strength toe-lift in tight clearances.
- Swivel sockets for easy operation.
- Use the safe dependable toe jacks and speed rollers to safely lift and move a heavy load in a low clearance situation.
- Super low height (the lowest in the industry) toe jacks, easy operation under the most difficult situations.
- These are the best choice for lifting heavy machinery and cargo, especially when installing industrial machinery, relocating shipyard equipment, or during bridge and plant construction.



Item	TOP CAP.	TOP-LIFT CAP.	TOE-LIFT STROKE	MIN.	MAX.	PISTON	BASE	HEIGHT	TOP-LIFT	WEIGHT
	U(Tons)	F(Tons)	(mm)	HEIGHT A(mm)	HEIGHT B(mm)	ROD DIA. J(mm)	DIMENSIONS LxW(mm)	H(mm)	L1xW1(mm)	
A2258-025	2.5	1.2	70	194	294	19	140 X 190	19	65 X 50	6.5
A2258-040	4	2	80	204	314	25	150 X 200	19	65 X 50	8.2
A2258-060	6	3	80	212	322	36	160 X 217	19	65 X 50	10
A2258-100	10	5	100	258	388	40	189 X 242	22	75 X 55	16.9
A2258-160	16	8	100	275	406	52	211 X 256	25	90 X 55	24.9
A2258-200	20	10	90	303	443	56	228 X 274	25	100 X 60	33
A2258-300	30	15	80	322	469	70	259 X 305	32	110 X 60	52
A2258-500	50	25	80	333	481	90	299 X 347	38	150 X 60	81

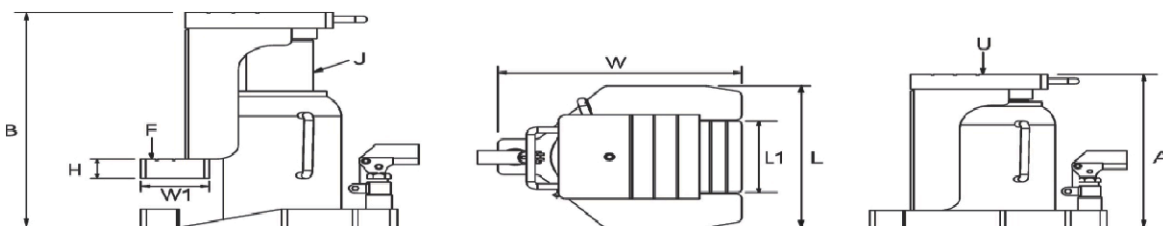



H.C.B-A1541

DIGITAL CALIPER

極速卡尺

Functions

- On/off: press <on> button once to turn on. Press button an additional time to turn off.
- Zero setting: press <zero> function button.
- Change measuring standard: Press <mm/in> function button.
- Absolute/incremental: press <abs> button, to return to zero function press button again.



Technical Data

- Measuring range: 0-6"/150 mm, 0-8"/200 mm, 0-12"/300 mm
- Resolution: 0.0005"/0.01 mm
- Accuracy: 6"/150 mm: ±0.001"/±0.02 mm
12"/150 mm: ±0.0015"/±0.04 mm
- Repeatability: 0.0005"/0.01 mm
- Measuring system: Capacitive
- Display: LCD (10.0 mm high)
- Maximum measuring speed: 120" per second
- Battery: 3V, type CR2032 Lithium
- Battery life: approx. 1 year
- Operational temperature range: 0°C to + 40°C
- Maximum relative humidity: 80%

H.C.B-A2283

Dr. 1/2" DEEP IMPACT SOCKET KIT (13 PCS) (10/11/12/13/14/16/17/19/21/22/24/27/30 mm)

Dr. 1/2" 長型氣動套筒組 (13 PCS) (10/11/12/13/14/16/17/19/21/22/24/27/30 mm)

- Sizes: 10 mm, 11 mm, 12 mm, 13 mm, 14 mm, 16 mm, 17 mm, 19 mm, 21 mm, 22 mm, 24 mm, 27 mm, 30 mm.



H.C.B-B2299

NEW

3 FUNCTION TIRE PRESSURE GAUGE (FOR CAR)

三用胎壓量錶 (小車)

- Multi-function tire pressure gauge: check pressure, Inflate, Deflate.
- Pressure Range: 0-15 kg/cm, 0-220 psi, 0-15 bar, 0-1500 kpa
- Aluminum die-casting body with H-D brass valve
- Air inlet: 1/4" PT





010

HWANG CHERNG BIN
Specialty Tools Inc.

一般修護工具 修護設備
General Repair Equipment

H.C.B-A2306

NEW

Dr. 3/4" TORQUE WRENCH (200-1000N.M)

Dr. 3/4" 扭力扳手 (200-1000 牛噸米)

- Industrial application.
- Wide range of choice.
- Tolerance of torque $\pm 3\%$.
- Easy torque-adjusting design brings energy-saving benefit.
- Applied to both clockwise and counterclockwise directions.
- Quality meets DIN ISO 6789 & ASME B107.300-2010.



General Repair
Equipment



H.C.B-A2316

NEW

MECHANICS CREEPER

臥板

- Made from durable, rust-proof fiberglass
- Ergonomically shaped: cut out arm areas for optimal elbow-room
- Padded head cushion
- Comfortable ergonomic shape
- Six wheels (hard rubber for smooth operation)
- Convenient tool trays
- Easy-to-clean surface
- Dimensions: 104.5 x 517 mm.



Innovative and functional



with assortment for BMW



010

HWANG CHERNG BIN
Specialty Tools Inc.

鈑金修護工具

PANEL REPAIR TOOL



H.C.B-A1011 SPOT WELDING SLIDE HAMMER KIT

自動點焊滑鎚

10 / 15.5 / 17.8 / 1.02'

- Directly weld to denting auto body. Pull with slide hammer without drilling a hole in the body.

Parts NO	Quantity	Description
1	1	Identity
2	4	Screw M6xP1.0
3	1	∅10x84L
4	1	∅10x55L
5	1	∅7/16" x336L
5-1	1	H21x17L
5-2	1	Screw M12xP1.5
6	1	Hammer

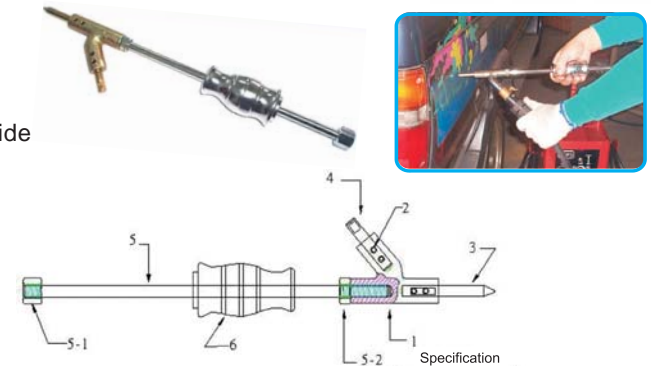

H.C.B-A1012 WASHER SLIDE HAMMER KIT

點焊滑鎚

10 / 15.3 / 17 / 1.32'

- Pull with slide hammer with washer in the body.

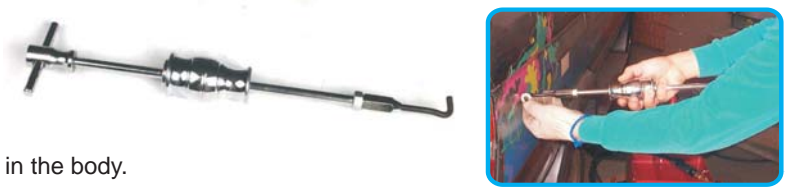

H.C.B-A1032 PANEL SLIDE HAMMER

車體鈹金滑鎚

- A master tool set for auto body shop.



H.C.B-A3018 SPOT WELDING SLIDE HAMMER KIT MINI MODEL

自動點焊滑鎚袖珍型

10 / 9.6 / 12 / 0.6'

- Directly weld to denting auto body. Pull with slide hammer without drilling a hole in the body.

Parts NO	Quantity	Description
1	1	Identity
2	4	Screw M6xP1.0
3	1	∅10x84L
4	1	∅10x55L
5	1	∅7/16" X210L
5-1	1	H21x17L
5-2	1	Screw M12xP1.5
6	1	Hammer

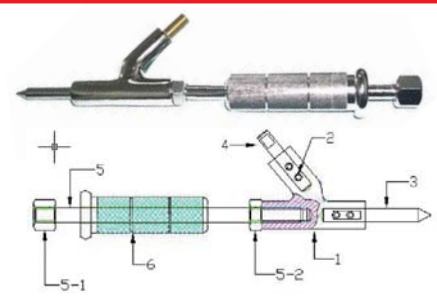

H.C.B-A3019 SPOT WELDING SLIDE HAMMER KIT MINI MODEL

自動點焊滑鎚袖珍型

10 / 10.9 / 12.7 / 0.6'

- Directly weld to denting auto body. Pull with slide hammer without drilling a hole in the body.





H.C.B-A1013 EXTENSION BAR

10 噸接杆組

- Combined with pump.
- N.W.: 8.3 KGS



H.C.B-A1014 ADJUSTABLE EXTENSION BAR

調整型接杆

- You can extend it by turning the bar.
- N.W.: 3 KGS



H.C.B-A3003 SPOT WELDER

自動點焊機

1 / 31 / 33 / 2.7'

- It promotes the speed of sheet metalling functional durable and strong welding.



H.C.B-A3016 AIR SPOT DRILL

點焊氣鑽 (直型)



H.C.B-A3017 AIR SPOT DRILL

點焊鑽除機

10 / 15 / 16 / 1.4'



H.C.B-A3001

10 TONS POWER PULLER PACKAGE

10 噸鈹金拉柱組

1 / 118 / 175 / 34.5'

- Adjustable pulley on tower performs both straight and angle pulls from 6" above base to maximum of 70".
- For using in conjunction with floor system for auto body repair.
- Equipped with two big wheels for the easy moving range of chains by pulling 50 cm.
- Gently remove pulley in desired height by hand only.
- N.W.: 118.5 KGS

Specification:

- | | |
|--------------------------|-------------------|
| 1: Panel pull rod | 1. 鈹金拉柱 |
| 2: Hydraulic cylinder | 2. 油壓缸 (10噸加長型) |
| 3: Chain | 3. 鍊條 (15尺) |
| 4: Air pump | 4. 氣動幫浦 (台製) |
| 5: Pulling pulley | 5. 鍊條滑輪 |
| 6: Main pulley | 6. 油壓缸撐頭 |
| 7: Pin | 7. 插銷 |
| 8: 90° fixing device | 8. 鈹金拉柱 90° 固定塊 |
| 9: Extension fixing (RV) | 9. 鈹金拉柱加高器 (休旅車用) |



H.C.B-B3001

10 TONS POWER PULLER PACKAGE

10 噸鈹金拉柱組

- To combine with A3001-2, A3001-3, A3001-4, A3001-5, A3001-6, A3041.
- It has to equipped with A3022 or A3023.



H.C.B-A3002

SIMPLER AND EASIER PANEL FRAME

簡易式鈹金拉柱

- This kind of panel puller frame has to be used.
- Specification:
W 700 mm x D 400 mm x H 1225 mm.





H.C.B-A3036

**AIR HYDRAULIC PUMP (1600 c.c.)
(Dr. 3/8" ADAPTOR)**

氣動幫浦 (1600 c.c.)
(Dr. 3/8" 接頭)



■ Application: 10~30 tons.

Sound level test	80 dba/m
N.W.	8.32 KGS
G.W.	8.5 KGS
CUFT	0.8'
Oil reservoir capacity	1600 c.c.

Hyd. pressure (PSI)	0	1000	2000	3000	4000	5000	6000	7000	8000	9000	10000
Oil flow (c.c./min)	1327	913	718	598	513	475	393	315	257	233	193

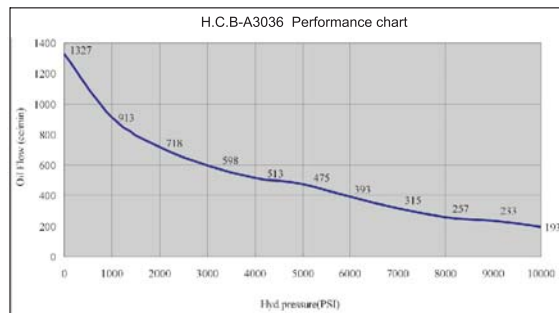

H.C.B-B3036

AIR HYDRAULIC PUMP(1800 c.c.)

氣動幫浦 (1800 c.c.)



■ Application: 10~30 tons.

Hyd. pressure (PSI)	0	1000	2000	3000	4000	5000	6000	7000	8000	9000	10000
Oil flow (c.c./min)	1170	970	850	700	600	515	440	370	315	250	195

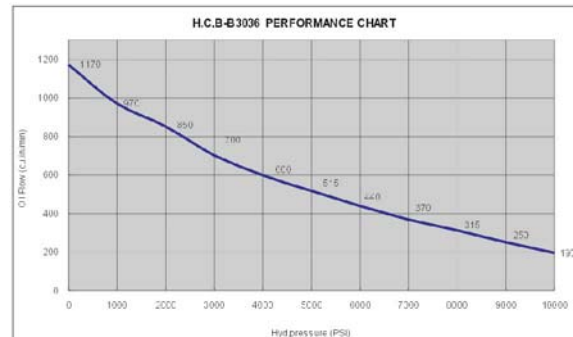

Model Number	Oil Capacity (c.c.)	Pressure Rating (psi)	Air Pressure Range (kg/cm ²)	Dimensions L*W*H(mm)	Sound Level Test (dba/m)	N.W. (Kgs)	G.W. (Kgs)
H.C.B-B3036	1800	10000	7 ~ 10	310*144*208.5	80	10.2	10.7

H.C.B-C3036

DOUBLE HOSE AIR HYDRAULIC PUMP (3800 c.c.)

雙管幫浦 (3800 c.c.)



■ Oil reservoir capacity: 3800 c.c.

Pressure (psi)	0	1000	2000	3000	4000	5000	6000	7000	8000	9000	10000
Oil Flow (c.c./min)	850	720	590	540	520	420	350	300	260	230	210

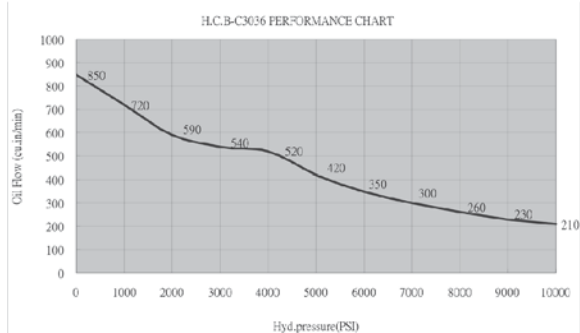

Item no.	Oil Capacity (c.c.)	Pressure Rating (psi)	Air Pressure Range (kg/cm ²)	Dimensions L*W*H(mm)	Sound Level Test (dba/m)	N.W. (Kgs)	G.W. (Kgs)	CUFT
H.C.B-C3036	3800	10000	7~10	470*147*210	80	11.6	12.6	1

H.C.B-D3036

AIR / HYDRAULIC PUMP (7600 c.c.)

氣動 / 油壓幫浦 (7600 c.c.)

inflow
1/4"-18NPT



outflow
3/8"-18NPT

Pressure (psi)	0	1000	2000	3000	4000	5000	6000	7000	8000	9000	10000
Oil Flow (c.c./min)	1170	970	850	700	600	515	440	370	315	250	195

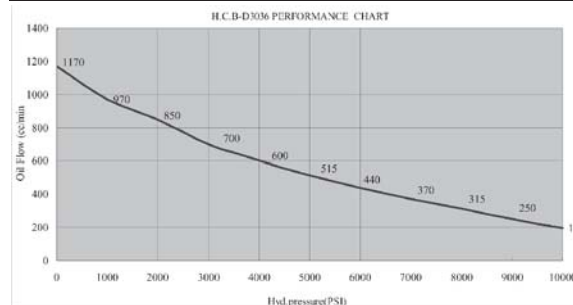

Item no.	Oil Capacity (c.c.)	Pressure Rating (psi)	Air Pressure Range (kg/cm ²)	Dimensions L*W*H(mm)	Sound Level Test (dba/m)	N.W. (Kgs)	G.W. (Kgs)	CUFT
H.C.B-D3036	7600	10000	7~10	352*289*250	80	22	23	1



H.C.B-E3036

AIR / HYDRAULIC FOOT PUMP (2000 c.c.) (WITHOUT HOSE)

氣動 / 油壓幫浦 (2000 c.c.) (不含管)

Intended use:

- For automotive / truck, industrial & construction jobs.
- The added convenience of an air motor reduces pumping time and effort to activate cylinders.

Features

- Designed to utilize exhaust air to help power the pump, requiring only 80 p.s.i. air pressure to develop 10,000 p.s.i. hydraulic pressure.
- Air exhaust muffler for quieter operation.
- Air and oil inlet filters for reduced risk of damage from contamination.
- Designed with durable light weight, corrosion resistant plastics.
- Foot pedal provides hands free pumping and release of load.
- Designed to be used with a single-acting cylinder.
- Internal pressure relief valve for overload protection.
- Equipped with a more durable aluminum reservoir.
- Comes with two different size poppit valves that can be quickly and easily installed. Poppit valves reduce the return flow of oil back to the pump's reservoir providing a safer controlled lowering of load.



MODEL NUMBER	HYDRAULIC PRESSURE RATING (P. S.I.)	USABLE OIL CAP. (Cu. In.)	OUTPUT FLOW RATE (Cu.In.Per Min.)		AIR PRESSURE RANGE(P. S.I.)	AIR CONSUMPTION (scfm)	VALVE FUNCTION	SOUND LEVEL (dBA)	THREAD CONNECTIONS		DIMENSIONS (Inches)			WEIGHT (Lbs.)
			No Load	Load					AIR (NPT)	HYDRAULIC (NPT)	Length	Width	Height	
E3035	10,000	122	80.5	12.8	40-170	24	Advance / Hold Retract	85	.25"-18	.375"-18	12.5	5.75	8	22

H.C.B-F3036

NEW

AIR/HYDRAULIC PUMP (WITHOUT HOSE) 6.2-6.8 BAR AIR PRESSURE / PUMP 230-245 BAR

氣動 / 油壓幫浦 (不含管) 6.2-6.8 BAR AIR PRESSURE / PUMP 230-245 BAR

INTENDED USE:

- For automotive, truck, industrial & construction jobs.
- The added convenience of an air motor reduces pumping time and effort to activate cylinders.

Features:

- Designed to utilize exhaust air to help power the pump, requiring only 80 p.s.i. air pressure to develop 10,000 p.s.i. hydraulic pressure.
- Air exhaust muffler for quieter operation.
- Air and oil inlet filters for reduced risk of damage from contamination.
- Designed with durable light weight, corrosion resistant plastics.
- Foot pedal provides hands free pumping and release of load.
- Designed to be used with a single-acting cylinder.
- Internal pressure relief valve for overload protection.
- Equipped with a more durable aluminum reservoir.
- Comes with two different size poppit valves that can be quickly and easily installed. Poppit valves reduce the return flow of oil back to the pump's reservoir providing a safer controlled lowering of load.



H.C.B-A3004

4 TONS PANEL REPAIR KIT

4 噸 鍍 金 組

- Quick "snap together" design for the fast and easy assembly and disassembly.
- Flexible hydraulic hose with spring guards at both ends.
- Rugged & welding construction features its hand pump base, which is made by forging for resisting of oil leakage under collision & denting.
- Components are also made by forging with the best rigidity and strength to ensure never broken during operation with high safety.
- Each components are connected through female connector for easy operation.





H.C.B-A3005

10 TONS TWO SPEEDS DYNAMIC POWER KIT

10 噸雙段油壓鉸金組

1 / 31 / 36 / 2.01'

- Quick "snap together" design for fast and easy assembly and disassembly.
- Flexible hydraulic hose with spring guards at both ends.
- Rugged & welding construction features its hand pump base is made by forging for resisting of oil leakage under collision & denting.
- Components are also made by forging with the best rigidity and strength to ensure never broken during operation with high safety.
- Each component is connected through female connector for easy operation.



H.C.B-A3006

EXTRA LARGE BODY SHEET SLIDE HAMMER KIT

鉸金滑鏈組 (5 件鋼製爪把)

2 / 16.3 / 24.5 / 1.48'

- Every attachment is made of steel plate and designed against the different angle & position availability.

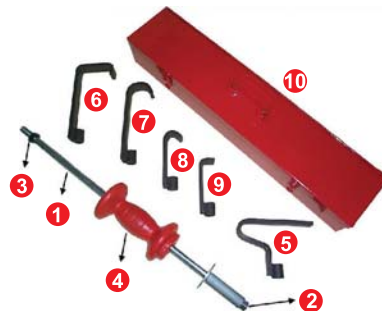

H.C.B-A3014

10 TONS HYDRAULIC CYLINDER (SPHERE)

10 噸球型壓桿組

NW: 7.5 KGS



H.C.B-A3015

10 TONS MINI HYDRAULIC CYLINDER

10 噸迷你油壓缸

NW: 1.4 KGS



120 mm

Dr. 2 1/4"
d: 40 mm



010
HWANG CHERNG BIN
Specialty Tools Inc.

鈹金修護工具
Panel Repair Tool

Panel Repair Tool

H.C.B-A3020 4 TONS CYLINDER

4 噸迷你油壓缸

30 / 18.3 / 20.5 / 0.67'

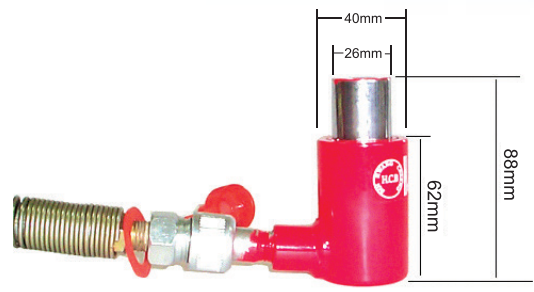

H.C.B-A3008 PULL RAMS (5 TONS)

5 噸油壓倒拉千斤頂

NW: 6KGS



H.C.B-A3021 10 TONS PULL RAMS

10 噸倒拉缸

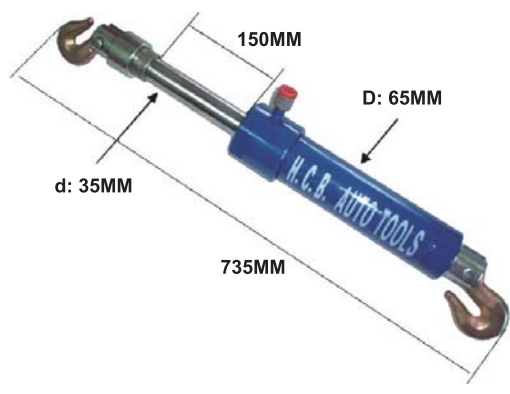

H.C.B-A3007 PULL HOOK KIT

深拉鉤組

2 / 21.5 / 23 / 1.03'





H.C.B-A3009

DOWN PULLY ASSEMBLY

底盤拉鉤

2 / 18.6 / 20 / 0.43'



H.C.B-A3010

10 TONS CHAIN FIXING BASE

鏈條錨座 (八卦台用)

6 / 24 / 24.5 / 0.31'

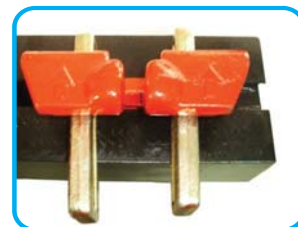

H.C.B-A3011

3 TONS SCISSOR CLAMP

剪型拉夾鉗

10 / 26 / 27 / 0.92'



H.C.B-A3012

AIR SAW

氣動鋸

20 / 13 / 14 / 1'

- Free speed: 9000 RPM
- Cutting size: 1.6 M/M
- Air inlet: 1/4"
- Air consumption: 230 L/ Min
- Length: 9-1/4" (235 M/M)
- Weight: 2.2 LBS (1 KG)





010
HWANG CHERNG BIN
 Specialty Tools Inc.

鈹金修護工具
Panel Repair Tool

Panel Repair Tool

H.C.B-B3012 AIR SAW

氣動鋸



H.C.B-A3012-1 AIR SAW BLADE

氣動鋸片

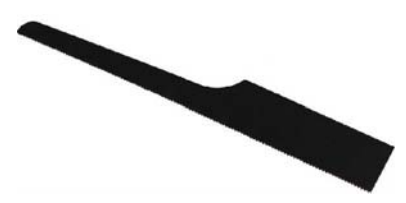

H.C.B-A3022 THE SYSTEM OF BODY REPAIR EQUIPMENT (FOR ONE CAR)

鈹金八卦台 (一台份)

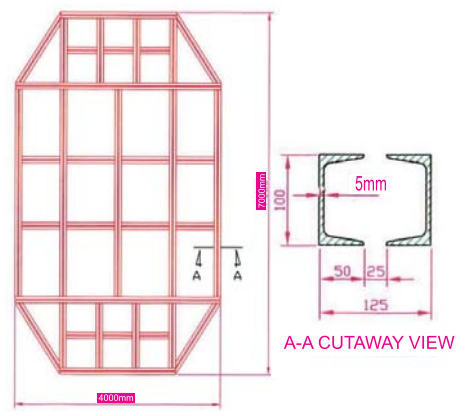

H.C.B-A3023 THE SYSTEM OF BODY REPAIR EQUIPMENT (FOR TWO CARS)

鈹金八卦台 (二台份)

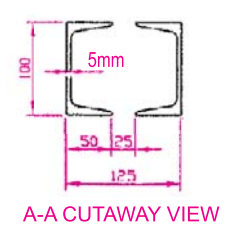
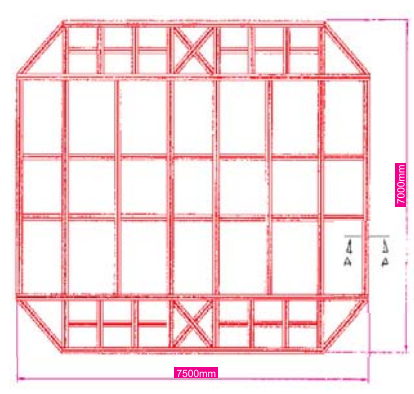



H.C.B-A3031

CLAMP ANCHOR BASE

油壓桿撐頭

- Use with 5/16" and 3/8" chains.
- Install on the top of H.C.B-A3001-2.



H.C.B-A3032

BALL PIVOT

油壓桿支轉頭

- Combined with H.C.B-A3001-2 and H.C.B-A3003.



H.C.B-A3033

BALL PIVOT BASE

支轉頭錨座

5 / 24.5 / 25 / 0.38'

- Applicable chain: 5/16", 3/8".
- Include two pins to fix the stander.
- The base of H.C.B-A3032.



H.C.B-A3029

ADJUSTABLE EXTENSION BAR

調整型接桿

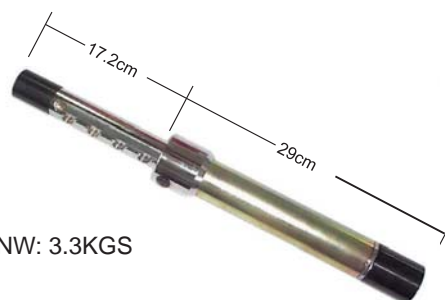

NW: 3.3KGS

H.C.B-A3030 **ADJUSTABLE EXTENSION BAR**

調整型接桿



NW: 5.4KGS

H.C.B-A3034 **STAND AUTO WELDER**

自動送料電焊機

- Single phase, robust and high efficiency.
- Easy to use.



■ Specification:

Main voltage	Phase	Power	Power Adjustment	Max. Welding Current	Duty cycle	Weight	Dimension (mm)
220V	1PH	5.5KVA	6 Steps	190A	165A 70%	49 kgs	780 x 345 x 450

H.C.B-A3035 **PORTABLE AUTO WELDER**

迷你型鈹金機

- Single phase, robust and high efficiency.
- Easy to use.
- Accessories:
 - Slide hammer x 1
 - Electrode for washer x 1
 - Carbon rod x 1
 - Round electrode x 1
 - Washer x 20
 - Trolley x 1 ----- optional



■ Specification:

Main voltage	Phase	Power	Power Adjustment	Max. Welding Current	Weight	Dimension (mm)
220V	1PH	12KVA	Micro-adjustment	3000A	25 kgs	405 x 205 x 205



H.C.B-A3037-A

ARCH ANCHOR BASE

弧度錨頭

- Application: All kinds of automobiles.
- To fix the door by using hydraulic cylinder with arch anchor base attached.
- It is convenient and easy to correct the damaged door frame, out of shape at arch anchor position.
- Accurate, easy to use, save time and money.
- Your best choice for panel repair.



H.C.B-A3037-B

ANGLE ANCHOR BASE

角度錨頭

- Application: All kinds of automobiles.
- To fix the door by using hydraulic cylinder with angel anchor base attached.
- It is convenient and easy to correct the damaged door frame, out of shape at 90° position.
- Accurate, easy to use, save time and money.
- Your best choice for panel repair.



H.C.B-A3038

UNIVERSAL BASE FRAME CLAMP KIT

萬能車底固定夾具組

- Base frame clamp set x 4 sets
- Fixed base x 4 pcs
- Locking pin x 8 pcs
- Accessory x 16 pcs
- Use the two clamps to hold and retain the car.
- The puller and clamps are adjustable. The range for fitting the place is changeable. The height of base frame is adjustable according to the cars in order to perform the maintenance.

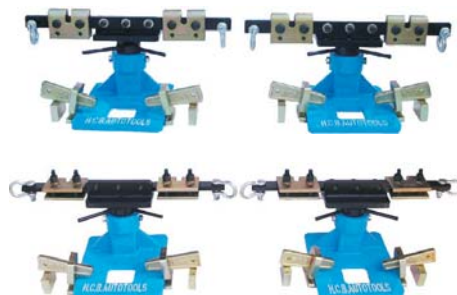

H.C.B-A3039

HYDRAULIC PLIERS

油壓撐開鉗

- Using with air pump.
- When the panel shapeless, the emergency solution is to enlarge the damaged part.





H.C.B-A3024

SMALL MOUTH PULL CLAMP (5 TONS)

窄型張引夾 (5 噸)

15 / 28 / 29 / 0.97'

- Capacity: 5 tons
- Bolt size: 16 mm \varnothing x 70 mm (L)
- Single-way pull operation

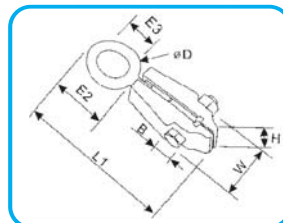

L1	W	H	E2	E3	B (bolt)	D (dia.)
210 mm	40 mm	44 mm	73 mm	41 mm	17 x 92 mm	13 mm

H.C.B-A3025

SMALL MOUTH PULL CLAMP (TWO-WAY)

窄型張引夾 (雙向)

10 / 11 / 12 / 0.39'

- Capacity: 5 tons (Straight way) and 2 tons (cross way)
- Bolt size: \varnothing 16 mm x 70 mm (L)
- Two-way pull operation.

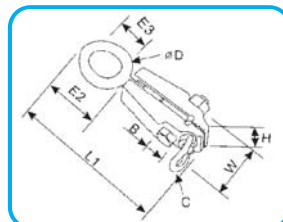

L1	W	H	E2	E3	B (bolt)	D (dia.)	C (L x W x H)	Weight (kg)
210 mm	40 mm	44 mm	73 mm	41 mm	17 x 92 mm	13 mm	50x60x11mm	2.12kg

H.C.B-A3026

BOX CLAMP (3 TONS)

寬型張引夾 (大小邊、3 噸)

12 / 25 / 26 / 1'

- Capacity: 3 tons
- Single-way pull operation
- Both sides' jaws are different in order to fit the confined room.
- Bolt size: \varnothing 14 mm x 70 mm (L)

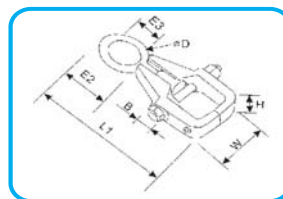

L	W	H	E2	E3	Fixing Bolt	D(dia)
225 mm	84 mm	37 mm	75 mm	14 mm	14 mm x 130 mm	13 mm

H.C.B-A3027

LONG NOSE CLAMP (2 TONS)

扁嘴型張引夾 (2 噸)

6 / 10 / 11 / 0.48'

- Capacity: 2 tons
- Bolt size: \varnothing 14 mm x 73 mm (L)
- Single-way pull operation
- The flat design is specialize for the confined room.

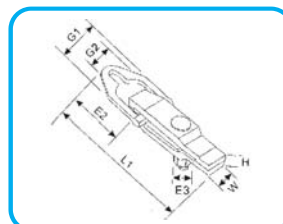

L	W	H	E2	E3(Bolt)	G1	G2
225 mm	32 mm	25 mm	115 mm	14 mm x 90 mm	66 mm	11 mm



H.C.B-A3028

MINI CLAMP (TWO-WAY)

迷你型張引夾 (雙向)

20 / 20 / 21 / 0.58'

- Capacity: 3 tons (Straight way) and 2 tons (cross way).
- Bolt size: Ø14 mm x 45 mm (L)
- Two-way pull operation.
- Special mini design is good to use in narrow and small space.

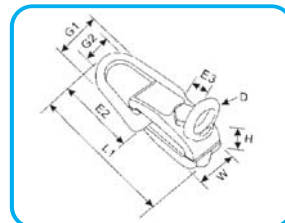

L1	W	H	E2	E3 (bolt)	G1	G2	D (L x W x H)
150 mm	37 mm	44 mm	84 mm	12 mm x 53 mm	62 mm	30 mm	41 mm x 9 mm

H.C.B-A3042

FRAME RACK CLAMP (5 TONS)

寬齒型張引夾 (5 噸)

6 / 16 / 17 / 0.67'

- SCM 440
- Capacity: 5 tons
- One-way pull operation.
- Serrate Length: 120 mm
- To use with plate makes it hard to be broken.
- Bolt size: Ø14 mm x 73 mm (L)

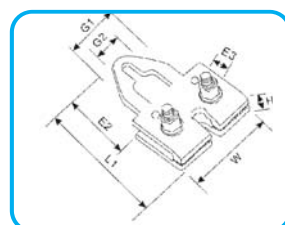

L1	W	H	E2	E3 (bolt)	G1	G2
180 mm	120 mm	35 mm	80 mm	17 mm x 88 mm	L77 mm	11 mm

H.C.B-A3043

BOX CLAMP (TWO-WAY)

寬型張引夾 (雙向)

5 / 11 / 12 / 0.46'

- Two-way pull operation.
- Two different jaws to fit the confined room.
- Capacity: Straight 3 tons
Cross 2 tons
- Bolt Size: Ø14 mm x 110 mm (L)

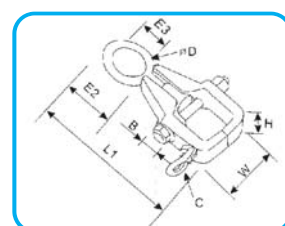

L1	W	H	E2	E3	B (bolt)	D (dia.)	C (L x W x H)
225 mm	84 mm	37 mm	75 mm	41mm	14 mm X 130 mm	13 mm	50 x 60 x 11 mm

H.C.B-A3040

STRUT PULLER KIT

避震器座拉引器

6 / 23.5 / 24 / 0.4'

- Overall length: 5".
- Capacity: 3 tons
- Easy, fast, reliable method for pulling strut towers.
- Develop for strutting towers without bolts, and correcting chassis dimensions to factory specifications. Strut tower removal is necessary.

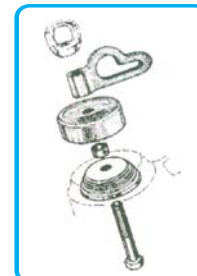

H.C.B-A3041 ANCHOR POT

地雷 (八卦台)



H.C.B-A3044 FRAME RACK CLAMP (MULTI-WAY)

寬齒型張引夾 (多方向)

6 / 21.5 / 22.5 / 1.24'

- Capacity: 5 tons (Straight way)
3 tons (Cross way)
3 tons (Multi-way)
- This puller is made from steel. It's hard to be broken.
- Bolt size: \varnothing 14 mm x 73 mm (L).

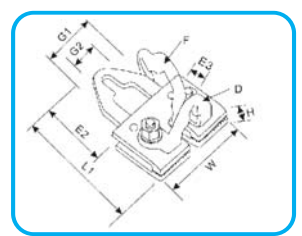

L1	W	H	E2	E3 (bolt)	G1	G2	D (L x W x H)	F (L x W x H)
180 mm	120 mm	35 mm	80 mm	17 mm x 88 mm	L77 mm	11 mm	77 x 100 x 10 mm	120 x 150 x 13 mm

H.C.B-A3045 FRAME RACK CLAMP (TWO-WAY)

寬齒型張引夾 (雙向)

6 / 18.5 / 19.5 / 1.04'

- Capacity: 5 tons (Straight way)
3 tons (Cross way)
- This puller is made from steel. It's hard to be broken.
- Bolt size: \varnothing 14 mm x 73 mm (L).

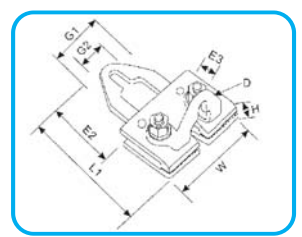

L1	W	H	E2	E3 (bolt)	G1	G2	D (L x W x H)
180 mm	120 mm	35 mm	80 mm	17 mm x 88 mm	L77 mm	11 mm	77 x 100 x 10 mm

H.C.B-A3046 HEAVY DUTY CLAMP

重型張引夾

6 / 18.5 / 19.5 / 0.6'

- Capacity: 5 tons
- For single-way pull operation.
- Special for exert pull.
- Bolt size: \varnothing 20 mm x 130 mm (L).

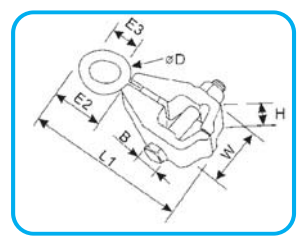

L1	W	H	E2	E3	B (bolt)
227 mm	100 mm	46 mm	75 mm	41 mm	19 mm x 153 mm L



H.C.B-A3047

CHAIN JOINT (DOUBLE GAP HOOKS)

雙勾型鍊條連接器 (間隙式)

10 / 12 / 13 / 0.3'

- Capacity: 6 tons
- To shorten or connect the chain.
- To work with 5/16" and 3/8" chains.

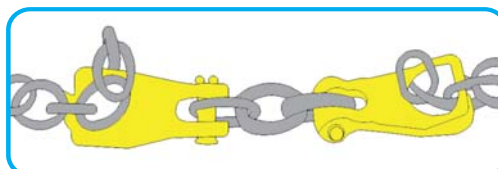

H.C.B-A3048

CHAIN JOINT

鍊條轉換器

10 / 10.5 / 11.5 / 0.21'

- Capacity: 6 tons
- To shorten or connect the chain.
- To work with 5/16" and 3/8" chains.
- To help two chains stay on the same level instead of twisted.

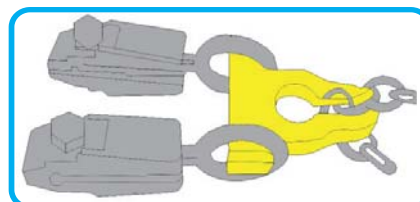

H.C.B-A3049

HANDY LINK

扁型鍊條連接器

10 / 6.5 / 7.5 / 0.17'

- Capacity: 6 tons
- To shorten and connect chains. It also connects with hooks.

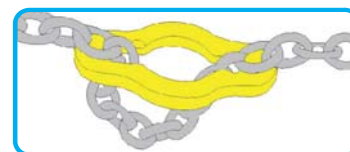

H.C.B-A3050

CHAIN HANDY HOOK

手掌型拉鉤

12 / 12.5 / 13.5 / 0.36'

- To pull and fix the hook into the indentation.

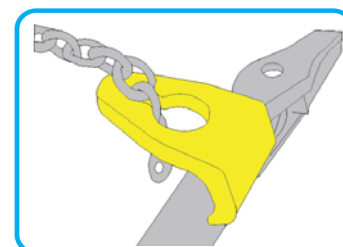

H.C.B-A3051 3" C TYPE CLAMP

3" C 型張引夾

6 / 18.5 / 19.5 / 1.54'

- Capacity: 5 tons
- Multi-way pull operation.
- Throat opening: 3"
- Small C-shaped for getting deeper into panel.

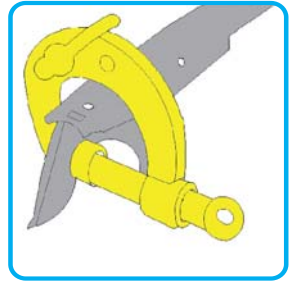

H.C.B-A3052 6" C TYPE CLAMP

6" C 型張引夾

4 / 19 / 20 / 1.6'

- Capacity: 4 tons
- Multi-way pull operation.
- Throat opening: 6"
- Large C-shaped for getting deeper into panel.



H.C.B-A3013 3 TONS MULTI-HOLE PULL PLATES

拖拉板

20 / 26.8 / 27.8 / 0.53'



H.C.B-A3053 LATERAL PULL PLATE

橫向拖拉板

10 / 18.5 / 19.5 / 0.47'

- Applicable chain: 5/16", 3/8"
- Fixed on the car to pull sidelong-line.

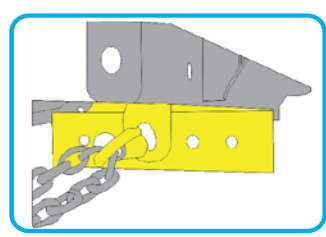



H.C.B-A3054

UNIBODY CLAMP

車板夾

6 / 11.5 / 15.5 / 0.34'

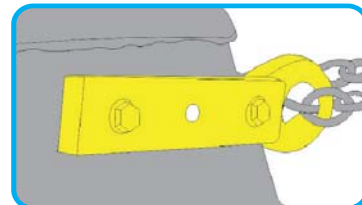

- For single-way pulling operation.
- If the damage is in the middle of car, it must be repaired by this clamp.

H.C.B-A3055

CHAIN JOINT (DOUBLE GRAB HOOKS)

雙勾型鍊條連接器 (掛勾式)

10 / 12 / 13 / 0.3'



- Capacity: 6 tons
- For shorten or connect the chain.
- To work with 5/16" and 3/8" chains.

H.C.B-A3056

CHAIN JOINT (GAP & GRAB HOOKS ASSEMBLY)

雙勾型鍊條連接器 (掛勾 & 間隙勾)



H.C.B-A3057

TIGHT OPENING CLAMP (3 TONS)

立式張引夾 (3 TONS)

- Gripping surface: 1½" wide (38 mm), ½" deep (13 mm)
- Overall length: 6½" (165 mm)
- Capacity: 3 tons



H.C.B-A3058

CORNER CLAMP

張引夾

- Drop forged Chrome Molybdenum alloy steel for maximum strength.
- Eliminate the need to use two separate clamps and will be able to get into confined areas.
- To be used with slide hammer.





010
HWANG CHERNG BIN
Specialty Tools Inc.

鍍金修護工具
Panel Repair Tool

Panel Repair Tool

H.C.B-A3059 CORNER CLAMP

張引夾

- Drop forged Chrome Molybdenum alloy steel for maximum strength.
- Eliminate the need to use two separate clamps and will be able to get into confined areas.

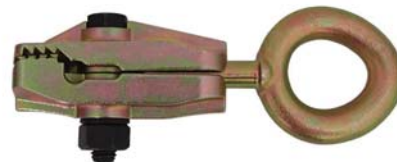

H.C.B-A3060 NEW CLEVIS SHORTENING CLUTCH (2 TONS)

U 型夾短掛勾 (2 噸)

H.C.B-B3060 NEW CLEVIS SHORTENING CLUTCH (3.15 TONS)

U 型夾短掛勾 (3.15 噸)

H.C.B-A3060
CLEVIS SHORTENING CLUTCH (2 TONS)



H.C.B-B3060
CLEVIS SHORTENING CLUTCH (3.15 TONS)



H.C.B-A3060

- This clutch secures the chain link in place to reduce the risk of chain deformation due to its design.
- Hooks are designed for using with Grade 80 alloy chain.
- The hook is not easy to loosen chain due to its feature.
- To shorten or grapple the long chain.
- Pass the chain through the groove to prevent from disengaging.
- The design of the clevis opening is to match the right chain size which can prevent from using the wrong chain, and to save the connecting link for alloy chain.
- Capacity, PASAK and WLL are embossed on the products.
- Construction: Heat treatment and high temperature treatment (Quenched and Tempered)
- Safety Factor: 4 : 1

Item No.	W.L.L.	Size	
	Ton	mm	inch
A3060	2.0	7-8	5 / 16"
B3060	3.2	10	3 / 8"

H.C.B-B3060

- There is no need for component connector owing to the special design of this clevis.
- This clutch secures the chain link in place reducing the risk of chain deformation due to its design.
- Hooks are designed for using with Grade 80 alloy chain.
- The hook is not easy to loosen chain due to its feature.
- To shorten or grapple the long chain.
- Pass the chain through the groove to prevent from disengaging.
- The design of the clevis opening is to match the right chain size which can prevent from using the wrong chain, and to save the connecting link for alloy chain.
- Capacity, PASAK and WLL are embossed on the products.
- Materia: High Tensile Forged Alloy Steel
- Construction: Heat treatment and high temperature treatment (Quenched and Tempered)
- Safety Factor: 4 : 1



H.C.B-A3061

NEW

DOOR FRAME PULLER (810-1000 mm)

車身門框撐開器 (810-1000 mm)

- Extension length: 810-1000 mm.
- Both sides have one clamp attached.
- Application:

When the door frame, engine, space or truck gets hit, this puller can hold one holding position with two clamps to fix the angle and increase holding coverage.



H.C.B-B3061

NEW

DOOR FRAME PULLER (1080-1600 mm)

車身門框撐開器 (1080-1600 mm)

- Extension length: 1080-1600 mm.
- Both sides have one clamp attached.
- Application:

When the door frame, engine, space or truck gets hit, this puller can hold one holding position with two clamps to fix the angle and increase holding coverage.





010

HWANG CHERNG BIN

Specialty Tools Inc.

冷氣修護工具

AIR CONDITIONING REPAIR TOOL



H.C.B-A5001

R-12 MANIFOLD GAUGE KIT

R-12 冷媒高低壓量錶組 (台製)(5 尺)



H.C.B-A5002

R134A MANIFOLD GAUGE KIT

R-134A 冷媒高低壓量錶組



H.C.B-A5003

AUTO A/C SWIVEL ADAPTERS KIT

冷媒快速接頭

- Adaptor: 1/4" x 1/4", 1/4" x 3/16", 1/4" x 1/8".
- Hose: 1/4" x 3/16", 1/4" x 1/8"
- Also GM R4 & A6, HR-6, DA-6 & V5 A/C compressors and compressors of sedan SD505, 507, 508, 510, 575, 708 and 709.
- 2 & 3 hole puller plate fits the most clutches, the mechanical force does the pulling job.



H.C.B-A5004

R134A LOW & HIGH PRESSURE QUICK COUPLING

冷媒高低壓快拆接頭 R134A 用 (附接頭)



H.C.B-A5005-EA

A/C TESTING TOOL KIT (EUROPEAN & AMERICAN)

冷氣測漏工具組 (歐美系)

- Various adaptor for testing leakage on each parts of air condition system.
- This tool is designed for testing drier, expansion valve, compressor, air condenser, and evaporator, etc.
- Application: European & American car.



H.C.B-A5005-JP

A/C TESTING TOOL KIT (JAPANESE)

冷氣測漏工具組 (日系綜合)

- Various adaptor for testing leakage on each parts of air condition system.
- This tool is designed for testing drier, expansion valve, compressor, air condenser, and evaporator, etc.
- Application: All Japanese car.



H.C.B-A5005-GE

A/C TESTING TOOL KIT (GENERAL)

冷氣測漏工具組 (一般)

- Various adaptor for testing leakage on each parts of air condition system.
- This tool is designed for testing drier, expansion valve, compressor, air condenser, and evaporator etc....
- Application: VW/AUDI, NISSAN-MARCH, GM, VOLVO, TOYOTA, HONDA, etc.



H.C.B-A5006

FLARING TOOL

銅管擴張器

- To flare or swage soft copper or aluminum tube.





010

HWANG CHERNG BIN
Specialty Tools Inc.

AIR CONDITIONING
REPAIR TOOL



H.C.B-A5008

COMPRESSOR BEARING EXTRACTION/ INSTALLATION TOOL KIT

壓縮機培林拆裝組

Removal and installation

Select the correct tool to remove the clutch hub.
According to removal steps as follows:



■ Clutch hub removal

1. Remove clutch retaining ring or nut.
2. Attach the tool to end plate by threading the outer nut of the tool into the center hole of the clutch end plate. (Nut type remover)
- 2-1. Attach the disk to end plate by threading the screws into the holes of the clutch end plate. (Disk type remover)
3. Tighten the inner tool arbor against the end of the compressor shaft to lift the plate. (Nut type remover)
- 3-1. Attach the push rod to the disk. Tighten the push rod against the end of the compressor shaft to lift the plate. (Disk type remover)

■ Clutch hub removal

1. Position the shaft key in place.
2. Slide the clutch hub onto the shaft of the compressor.
3. Take the button out the outer nut. Insert the bearing into the cylindrical end of outer nut.
4. Put the outer nut with bearing into the hole of the clutch end plate by cylindrical end.
5. Thread the inner part of the tool onto the shaft. Tighten the outer nut of the tool to push the clutch end plate back.
6. Set the air gap. Add or remove shims to obtain the MFG, specifications. Always set at the minimum number and measure at multiple points around the circumference.
7. Reinstall the retain ring or nut.

H.C.B-A5007

CHARGING CYLINDER

冷媒定量筒

- Make charging fast and accurate to save your time and money.
- Using a charging cylinder eliminates under and over-charging which reduces additional service.
- It has a precision gauge and a clearly calibrate that you could charging more quickly and correctly.
- For use both on R-134a and R-12 system.
- Capacity: 3200 g (7LB).



NW: 4.5KGS

H.C.B-A5009

VACUUM PUMP

冷媒真空幫浦 (推車型)

- Designed for vacuum and pressure test.
- With the relief valve for security, it will be urgent stop when it close to 350 psi.
- This tool has the charging window for survey, and the special design bottle to separate the oil and water.
- Voltage: AC-110V
- Capability: 1/3 HP.



H.C.B-A5010

A/C COMPRESSOR CLUTCH REMOVER (DOUBLE HEAD THREADS)

壓縮機離合器拆卸器 (雙頭牙)

- To remove the plate of clutch.
- Application: most of American cars





010
HWANG CHERNG BIN
Specialty Tools Inc.

冷氣修護工具
Air Conditioning Repair Tool

AIR CONDITIONING
REPAIR TOOL

H.C.B-A5011 A/C SPRING DISCONNECT TOOLS FOR TOYOTA

TOYOTA 冷氣管路拆卸器

- Special design for removing the spring lock coupling in A/C system
- Two tools in a set for the different size of coupling.
- Application: TOYOTA after 2000.



H.C.B-B5011 A/C SPRING LOCK COUPLING TOOLS FOR TOYOTA

TOYOTA 冷氣管路固定夾

- These tools are spring-loaded to close them to deflect any spray that occurs when the line is disconnected.
- Application: TOYOTA after 2000.



H.C.B-A5012 UNIVERSAL VALVE CORE REMOVAL/INSTALLATION TOOL KIT

冷煤氣嘴拆裝工具組

- This master tool kit allows you to service valve cores without losing the systems charge.
- The new unique design offers a locking device that holds the shaft in place while removing or installing the valve core. The remover/installer kit makes removal or insertion much easier especially on the larger R134a valve cores.
- Saves time and money.
- This new kit is an innovative tool saving time and money.
- This kit allows the user to change the service port valve core while the system is charged. The unique design cuts the usual 1/2-hour procedure time down to about 3 minutes.
- Kit covers all R12 & R134a system valve cores.



H.C.B-A5013 UNIVERSAL FLARING TOOL

銅管擴張器

- This universal tool is capable of producing all SAE and DIN flares as well as the special flares used by CITROEN and ROLLS-ROYCE. Vice mounted, with nothing to set or adjust, pipe positioning is automatic and there is a fail-safe method for locating the unique hardened wedge-shaped clamps. Different part numbers are used to determine the punch and clamp sets supplied with each tool. All sizes are available from 3/16" (4.75 mm) to 1/2" (12 mm) including 3.5mm, 4.5mm and 6.35mm for Citroen and Rolls-Royce.





010

HWANG CHERNG BIN Specialty Tools Inc.

機械五金類

MACHINERY & HARDWARE





H.C.B-A6001

HYDRAULIC ELEVATOR CART (300 KGS)

油壓升降推車 (300 KGS)



Model	Capacity	Max Height	Min Height
H.C.B-A6001	300 KGS(135.9 LBS)	882 mm	267 mm
Table Size	Net Weight	Handle	Wheel
800 mm x 500 mm	71.2 KGS	Fix type	5.4 INch

H.C.B-A6002

ELECTRIC CABLE RACK (HYDRAULIC)

電纜放線架 (油壓式)



H.C.B-A6004

DISPLAY SHELF
(L: 945 W: 490 H: 2100 mm)

展示架
(L: 945 mm W: 490 mm H: 2100 mm)

1 / 42 / 43.5 / 3.6'



- This tool is designed to draw the customer's attention and communicate the main features of the products belonging to the product range.
- Easy to assemble & disassemble.
- The displays are equipped with adjustable shelves with raised frontal part to comfortably support our kits.
- Size: L: 945 mm x W: 490 mm x H: 2100 mm.
- Works with H.C.B-A1051-3.

H.C.B-A6003

MOTORCYCLE LIFT

機車頂車機

1 / 138 / 158 / 18.2'



- Loading: 300 KGS.
- Applicable 110/220 V.





H.C.B-A8001

MULTI-FUNCTION PNEUMATIC/HYDRAULIC ENGINE LIFT PAT.M 430377

多功能剪型氣 / 油壓引擎拆卸設備

- This is the best extracting tool for all kinds of transmission and engine. It can afford both weights of engine and transmission at the same time.
- Seven support frames on platform are adjustable depend on the size of transmissions or engines. It also increases the safety and stability.
- Four swivel caster wheels and pull rod design makes this equipment easy to move.
- Scissor structure.
- Power source: Dual-use design- hydraulic control and manual control.
- Capacity: 1.5 tons.
- Stroke: 1250 mm.
- Min height: 400 mm.
- Max Height: 1650 mm.





010

HWANG CHERNG BIN
Specialty Tools Inc.

氣動工具

AIR POWER TOOL



1085Nm





H.C.B-A2005

1/2" AIR IMPACT WRENCH

1/2" 氣動扳手 (下排式)

■ Specification / 規格 :

- Square drive / (方榫)-----1/2" (12.7 mm)
- Free speed (轉速)-----6000 RPM
- Max.Torque (最大扭力)-----420 ft-lbs (570 Nm) / 570 (牛頓·米)
- Air inlet (進氣口規格)-----1/4" NPT (6.35 mm)
- Weight (重量)-----6 lbs (2.7 kgs)
- Overall length (全長)-----7.4" (188 mm)



H.C.B-A2005-1

1/2" AIR IMPACT WRENCH (WITH 10PCS SOCKET)

1/2" 氣動扳手 (下排式, 含套筒)

■ Specification of air ratchet wrench / 氣動扳手規格 :

- Square drive / (方榫)-----1/2" (12.7 mm)
- Free speed (轉速)-----6000 RPM
- Max torque (最大扭力)-----420 ft-lbs (570 Nm) / 570 (牛頓·米)
- Air inlet (進氣口規格)-----1/4" NPT (6.35 mm)
- Weight(重量)-----6 lbs (2.7 kgs)
- Overall length (總長)-----7.4" (188 mm)

■ Specification of socket / 套筒尺寸 :

- 1: 27 mm 6: 17 mm
- 2: 24 mm 7: 14 mm
- 3: 22 mm 8: 13 mm
- 4: 21 mm 9: 12 mm
- 5: 19 mm 10: 10 mm

■ N.W. / 淨重 :4.22 KGS



H.C.B-B2025

3/8" AIR MINI RATCHET WRENCH

3/8" 氣動棘輪扳手

- The tool is constructed of the best light material including a sturdy noise cap, handy power regulator and control trigger. All fit your fingertips.

- 本工具以輕量化材質製造，包含堅固的接榫、靈敏的調節閥和開關控制器。完全適合您使用。

■ Specification / 規格 :

- Square drive / (方榫)-----3/8"
- Free speed (轉速)-----240 RPM
- Max torque (最大扭力)-----18 ft-lbs
- Air inlet (進氣口規格)-----1/4" NPT
- Air pressure bar(空壓)-----90 psi
- Air consumption(耗氣量)-----3 CFM
- Weight (重量)-----1.1 lbs (0.55 kgs)
- Overall length (總長)-----7"



H.C.B-A2034

1/4" 90° AIR STUBBY AIR RATCHET WRENCH

1/4" 90°氣動扳手



- Specification / 規格 :
- Square drive(方榫)-----1/4"
- Free speed (轉速)-----240 RPM
- Max. Torque (最大扭力)-----18 ft-lbs
- Air inlet (進氣口規格)-----1/4" NPT
- Air pressure bar (空壓)-----90 psi
- Air consumption (耗氣量)----3 CFM
- Weight (重量)-----1.1 lbs (0.55 kgs)
- Overall length (全長)-----6 - 5/16"

H.C.B-A2046

1/2" 90° STUBBY AIR RATCHET WRENCH

1/2" 90° 氣動扳手



- Specification / 規格 :
- Square drive (方榫)-----1/2"
- Free speed (轉速)-----150 RPM
- Max. Torque (最大扭力)-----60 ft-lbs
- Air inlet (進氣口規格)-----1/4"NPT
- Weight (重量)-----2.86 lbs (1.3 kgs)
- Overall length (全長)-----10" (254 mm)

H.C.B-A2047

AIR DIE GRINDER

氣動刻模機



H.C.B-A2048

16 PCS AIR DIE GRINDER KIT

氣動刻模機組 (16 PCS)



H.C.B-A2139 **1/2" MINI IMPACT WRENCH**

1/2" 輕型氣動扳手

- Specification / 規格 :
- Square drive (方榫)-----1/2"
- Bolt size (螺栓能力)-----14 mm
- Free speed (轉速)-----12500 RPM
- Max. Torque (最大扭力)-----300 ft-lbs
- Overall length (全長)-----145 mm
- Air inlet (進氣口規格)-----1/4"NPT
- Hose size (風管規格)----- 3/8"
- Weight (重量)-----1.5 kgs



Item	SQ.	Bolt Size	Speed	Torque	Length
H.C.B-A2139	1/2"	14 mm	12500	300 ft/ib	145 mm

Item	Inlet	Hose	CFM	L/Min	Weight
H.C.B-A2139	1/4"	3/8"	3	85	1.50 kg



H.C.B-A2173

1/2" 90° AIR RATCHET WRENCH

1/2" 90° 氣動棘輪扳手

- Specification / 規格 :
 - Square drive (方榫)-----1/2"
 - Free speed (轉速)-----160 RPM
 - Max. torque (最大扭力)-----55 ft-lbs (7.6 kg-m)
 - Air inlet (進氣口規格)-----1/4" NPT
 - Air consumption (耗氣量)-----3 CFM (L/min)
 - Overall length (全長)-----9-3/8" (238 mm)
 - Weight (重量)-----2.52 lbs (1.14 kgs)



H.C.B-A2200

3/4" IMPACT WRENCH

3/4" 氣動扳手

- Specification / 規格 :
 - Square drive (方榫)-----3/4" (19mm)
 - Free speed (無載轉速)-----5,000 RPM
 - Max. torque (最大扭力)-----1250 ft-lbs(1695 Nm) / 1695 牛頓·米
 - Bolt size (螺栓能力)-----1-1/4" (32 mm)
 - Net weight (淨重)-----9.6 lbs (4.3 kgs)
 - Overall length (全長)-----8.5" (217 mm)
 - Avg. Air consumption (平均耗氣量)-----3 CFM (L/min)
 - Air inlet (進氣口規格)-----3/8" NPT
 - Air pressure bar (空壓)-----90 psi (6.3 kg/cm2)
 - Sound level (音壓)-----96 dBA



H.C.B-A2285

1/2" MINI COMPOSITE IMPACT WRENCH (JAMBO HAMMER)

4 分塑膠手柄迷你單環捶打式衝擊扳手

- Specification / 規格 :
 - Free speed (轉速)-----9,500 RPM
 - Max. torque (最大扭力)-----500 呎 - 磅 (ft-lbs), 678 Nm
 - Net weight (淨重)-----1.15 kg
 - Overall length (全長)-----112 mm
 - Air inlet (進氣口規格)-----1/4"
 - Hose size (風管規格)-----3/8"



H.C.B-A2286

1/2" COMPOSITE IMPACT WRENCH (TWIN HAMMER)

4 分塑膠手柄雙環捶打式衝擊扳手

- Specification / 規格 :
 - Free speed (轉速)-----7,300 RPM
 - Max. torque (最大扭力)-----800 呎 - 磅 (ft-lbs), 1,085 Nm
 - Net weight (淨重)-----2.0 kg
 - Overall length (總長)-----175 mm
 - Air inlet (進氣口規格)-----1/4"
 - Hose size (風管規格)-----3/8"





010
HWANG CHERNG BIN
Specialty Tools Inc.

氣動工具

Air Power Tools

H.C.B-B2286

3/8" COMPOSITE IMPACT WRENCH (TWIN HAMMER) 475 NM

3 分塑膠手柄雙環捶打式衝擊扳手 (扭力 475 牛頓米)

■ Specification / 規格 :

- Free speed (轉速)-----10,500 RPM
- Max. torque (最大扭力)-----450 呎 - 磅 (ft-lbs), 610 Nm
- Net weight (淨重)-----1.29 kg
- Overall length (全長)-----150 mm
- Air inlet (進氣口規格)-----1/4"
- Hose size (風管規格)-----3/8"



H.C.B-A2287

3/4" COMPOSITE IMPACT WRENCH (TWIN HAMMER)

6 分塑膠手柄雙環捶打式衝擊扳手

■ Specification / 規格 :

- Free speed (轉速)-----7,300 RPM
- Max. torque (最大扭力)-----1,400 呎 - 磅 (ft-lbs), 1,898 Nm
- Net weight (淨重)-----3.3 kg
- Overall length (全長)-----202 mm
- Air inlet (進氣口規格)-----3/8"
- Hose size (風管規格)-----1/2"



H.C.B-B2200

NEW

3/4" ALUMINUM HOUSING IMPACT WRENCH

3/4" 鋁合金氣動扳手

■ Specification:

- Free speed (轉速)-----5,800 rpm
- Max. torque @ 90 psi (最大扭力)-----1,750 ft-lb/ 2373 Nm
- Net weight (淨重)-----13.50 lbs (6.10kgs)
- Overall length (全長)-----228 mm (9.0 inch)
- Air inlet (進氣孔規格)-----3/8 inch
- Air hose id (風管規格)-----1/2 inch
- Average. Air consumption (耗氣量)---2271 l/min
- Lpa (聲壓)-----105 db (a)
- Work pressure (工作壓力)-----90 psi



Air Power Tools





HWANG CHERNG BIN Specialty Tools Inc. National Tools trade show



**FRANKFURT
AUTOMECHANIKA SHOW**



**ITALY AUTOPROMOTEC
SHOW**



FRANCE EQUIP AUTO SHOW



TAIWAN AMPA SHOW



RUSSIA MIMS SHOW



**MIDDLE EAST
AUTOMECHANIKA SHOW**



USA AAPEX SHOW



**POZNAN TTM
AUTOMOTIVE SHOW**



KOREA KOAA SHOW



JAPAN IAAE SHOW





**HWANG CHERNG BIN
Specialty Tools Inc.**



**PICTURE TAKEN WITH LEBANON
CLIENT IN 2009 AMPA SHOW**



**PICTURE TAKEN WITH ISRAEL CLIENT
IN 2013 AUTOPROMOTEC SHOW**



**PICTURE TAKEN WITH CYPRUS
CLIENT IN 2010 FRANKFURT
AUTOMECHANIKA SHOW**



**AUSTRALIAN CLIENT VISITED
H.C.B COMPANY**



**PICTURE TAKEN WITH NEW ZEALAND
CLIENT IN 2014 AAPEX**



**PICTURE TAKEN WITH GERMANY
CLIENT IN 2010 FRANKFURT
AUTOMECHANIKA SHOW**



SINCE 1990

HWANG CHERNG BIN Specialty Tools Inc.



PICTURE TAKEN WITH AUSTRALIAN CLIENT IN 2015 AMPA SHOW



PICTURE TAKEN WITH INDONESIAN CLIENT IN 2008 AMPA SHOW



PICTURE TAKEN WITH JAPANESE CLIENT IN 2009 AMPA SHOW



PICTURE TAKEN WITH POLAND CLIENT IN 2014 FRANKFURT AUTOMECHANIKA SHOW



PICTURE TAKEN WITH MALAYSIA CLIENT IN 2014 AMPA



PICTURE TAKEN WITH HONG KONG CLIENT IN 2012 AMPA SHOW



HWANG CHERNG BIN
Specialty Tools Inc.



**PICTURE TAKEN WITH FINLAND
CLIENT IN 2015 AMPA SHOW**



**PICTURE TAKEN WITH IRELAND
CLIENT IN 2012 AUTOMECHANIKA
FRANKFURT SHOW**



**PICTURE TAKEN WITH FINLAND
CLIENT IN 2014 AUTOMECHANIKA
FRANKFURT SHOW**



**PICTURE TAKEN WITH LITHUANIA
CLIENT IN 2012 AUTOMECHANIKA
FRANKFURT SHOW**



**PICTURE TAKEN WITH CHINA CLIENT
IN 2012 FRANKFURT AUTOMECHANIKA
SHOW**



**PICTURE TAKEN WITH KOREAN
CLIENT IN 2013 KOAA SHOW**

朱子治家格言

○黎明即起，灑掃庭除，要內外整潔。

○既昏便息，關鎖門戶，必親自檢點。

○一粥一飯，當思來處不易，親自撿點。

○半絲半縷，恆念物力維艱。

○宜未雨而綢繆，毋臨渴而掘井。

○器具質而潔，瓦缶勝金玉。

○飲食約而精，園蔬勝珍饈。

○勿營華屋，勿謀良田。

○三姑六婆，實淫盜之媒。

○婢媵勿用，非閨房之福。

○奴僕勿用，非妻妾之恥。

○祖宗雖遠，祭祀不可不誠。

○子孫雖愚，經書不可不讀。

○居身務期，樸教子要有義方。

○勿貪意外之財，勿飲過量之酒。

○見貧苦親鄰，須多溫恤。

○刻薄成家，理無久享。

○倫常乖舛，立見消亡。

○兄弟叔姪，須分潤寡。

○長幼內外，宜法嚴寡。

○聽婦言，乖骨豈成人子。

○重資擇佳婿，父母不聽成。

○娶媳求淑女，不計厚奩。

○見富貴而生驕，最可恥。

○遇貧窮而作態，賤莫甚。

○居家戒爭訟，訟則終凶。

○處世戒多言，言多必失。

○毋恃勢多力，凌逼孤寡。

○乖僻自是，悔誤必多。

○狎昵自是，久必受其累。

○屈志老成，急則相依。

○輕聽發言，安知非人之譖。

○當忍耐三思，須平心遭暗想。

○安知非我之不是，事須平心遭暗想。

○凡事當留餘，受恩莫忘。

○凡有喜慶，不可得意，不宜再往。

○人人有喜慶，不可得意，不宜再往。

○善欲人見，不可生善心。

○惡恐人知，便是大惡。

○見色而起淫心，報在妻女。

○匿怨而用暗箭，禍延子孫。

○家門和順，雖饗飧不繼。

○亦有余歡，國課早完。

○即囊橐無餘，自得至樂。

○讀書志在聖賢，為官心存君國。

○守分安命，庶乎近焉。

○為人若此，庶乎近焉。



SINCE 1990

HWANG CHERNG BIN SPECIALTY TOOLS INC.
No.25-120, Shiyizhicuo, Longder Village,
Shuishang Township, Chiayi County, 60859,
Taiwan, R.O.C.

TEL:886-5-2603816,886-5-2600820
FAX:886-5-2603817, Order FAX:886-5-2601595
E-mail: service@hcb-autotools.com.tw
hcb@hcb-autotools.com.tw

www.hcb-autotools.com

Location: 23.43001N, 120.38757E

201603



Find out everything you need to know about our products Scanning QR CODE to watch the video demonstration.

